

SERIES: PYBJ10 | **DESCRIPTION:** DC-DC CONVERTER

FEATURES

- up to 10 W isolated output
- 4:1 input range (9~36 Vdc)
- single regulated output
- output over-voltage protection, over-current protection, short-circuit protection
- efficiency up to 88%
- DIP and SMT mounting styles
- available with or without case
- UL 62368-1, IEC 62368-1, EN 62368-1 approved

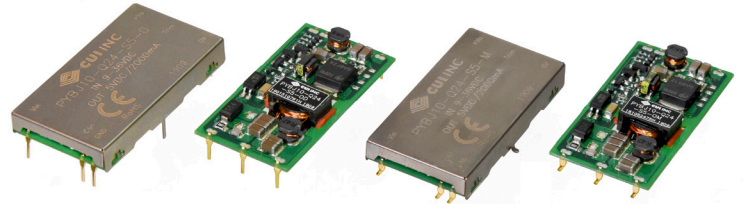

| MODEL | input voltage | | output voltage | output current | | output power | ripple & noise ¹ | efficiency ² |
|----------------|---------------|-------------|----------------|----------------|----------|--------------|-----------------------------|-------------------------|
| | typ (Vdc) | range (Vdc) | (Vdc) | min (mA) | max (mA) | max (W) | max (mVp-p) | typ (%) |
| PYBJ10-Q24-S5 | 24 | 9~36 | 5 | 0 | 2000 | 10 | 100 | 84 |
| PYBJ10-Q24-S12 | 24 | 9~36 | 12 | 0 | 833 | 10 | 100 | 87 |
| PYBJ10-Q24-S15 | 24 | 9~36 | 15 | 0 | 667 | 10 | 100 | 88 |

Notes: 1. From 5~100% load, nominal input, 20 MHz bandwidth oscilloscope, with 10 µF tantalum and 1 µF ceramic capacitors on the output. From 0~5% load, ripple and noise is <5% Vo.
 2. Measured at nominal input voltage, full load.
 3. All specifications are measured at Ta=25°C, humidity < 75%, nominal input voltage, and rated output load unless otherwise specified.

PART NUMBER KEY

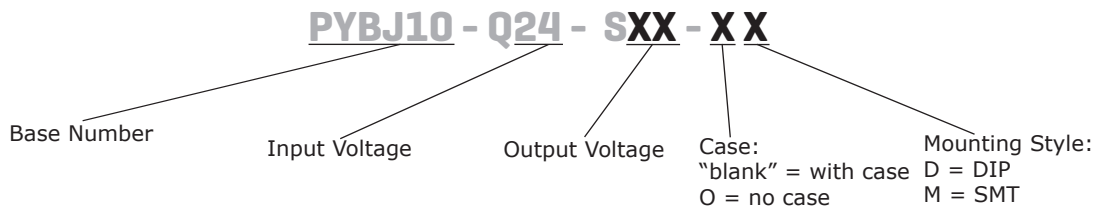

INPUT

| parameter | conditions/description | min | typ | max | units |
|-----------------------------------|---|------|-----|-----|-------|
| operating input voltage | | 9 | 24 | 36 | Vdc |
| start-up voltage | | | | 9 | Vdc |
| surge voltage | for 1 second max | -0.7 | | 50 | Vdc |
| under voltage shutdown | | 5.5 | 6.5 | | Vdc |
| current | 5 Vdc output models | | | 508 | mA |
| | 12 Vdc output models | | | 490 | mA |
| | 15 Vdc output models | | | 485 | MA |
| remote on/off (CTRL) ⁴ | turn on (CTRL pin pulled low to GND (0~1.2 Vdc)) turn off (CTRL pin open or pulled high (2.4~12 Vdc)) input current when switched off | | 6 | | mA |
| filter | Pi filter | | | | |
| no load power consumption | | | 0.1 | | W |

Notes: 4. The voltage of the CTRL pin is referenced to input GND pin.

OUTPUT

| parameter | conditions/description | min | typ | max | units |
|--------------------------------------|---|-----|------|-------|-------|
| maximum capacitive load ⁵ | 5 Vdc output models | | | 2,200 | μF |
| | 12 Vdc output models | | | 680 | μF |
| | 15 Vdc output models | | | 470 | μF |
| voltage accuracy | from 0% to full load | | ±1 | ±3 | % |
| line regulation | from low line to high line, full load | | ±0.2 | ±0.5 | % |
| load regulation ⁶ | from 5% to full load | | ±0.5 | ±1 | % |
| adjustability | see application notes | | ±5 | | % |
| switching frequency ⁷ | PWM mode | | 350 | | kHz |
| transient recovery time | 25% load step change, nominal input voltage | | 300 | 500 | μs |
| transient response deviation | 25% load step change, nominal input voltage | | ±3 | ±5 | % |
| temperature coefficient | at full load | | | ±0.03 | %/°C |

Note: 5. Tested at input voltage range and full load.

6. At 0~100% load, the max load regulation is ±5%.

7. Value is based on full load. At loads <50%, the switching frequency decreases with decreasing load for efficiency improvement.

PROTECTIONS

| parameter | conditions/description | min | typ | max | units |
|--------------------------|-----------------------------------|-----|-----|-----|-------|
| over voltage protection | | 110 | | 160 | % |
| over current protection | | 110 | 140 | 200 | % |
| short circuit protection | hiccup, continuous, auto recovery | | | | |

SAFETY AND COMPLIANCE

| parameter | conditions/description | min | typ | max | units |
|-----------------------|---|-----------|-------|-----|-------|
| isolation voltage | input to output for 1 minute at 5 mA | 500 | | | Vac |
| | input to case ⁸ for 1 minute at 5 mA | 500 | | | Vac |
| | output to case ⁸ for 1 minute at 5 mA | 500 | | | Vac |
| | input to output for 1 minute at 1 mA | 1,500 | | | Vdc |
| | input to case ⁸ for 1 minute at 1 mA | 1,500 | | | Vdc |
| | output to case ⁸ for 1 minute at 1 mA | 1,500 | | | Vdc |
| isolation resistance | input to output at 500 Vdc | 100 | | | MΩ |
| | input to case ⁸ at 500 Vdc | 100 | | | MΩ |
| | output to case ⁸ at 500 Vdc | 100 | | | MΩ |
| isolation capacitance | input to output, 100 kHz / 0.1 V | | 1,000 | | pF |
| safety approvals | UL 62368-1, IEC 62368-1, EN 62368-1 | | | | |
| conducted emissions | CISPR32/EN55032, class A (no external circuit); class B (external circuit required, see Figure 2-a) | | | | |
| radiated emissions | CISPR32/EN55032, class B (external circuit required, see Figure 2-a) | | | | |
| ESD | IEC/EN61000-4-2, contact ±6 kV, class B | | | | |
| radiated immunity | IEC/EN61000-4-3, 10 V/m, class A | | | | |
| EFT/burst | IEC/EN61000-4-4, ±2 kV, class B (external circuit required, see Figure 2-b) | | | | |
| surge | IEC/EN61000-4-5, line-line ±2 kV, class B (external circuit required, see Figure Figure 2-b) | | | | |
| conducted immunity | IEC/EN61000-4-6, 3 Vr.m.s, class A | | | | |
| MTBF | as per MIL-HDBK-217F, 25°C | 1,000,000 | | | hours |
| RoHS | yes | | | | |

Note: 8. Only applies to versions with case.

ENVIRONMENTAL

| parameter | conditions/description | min | typ | max | units |
|-----------------------|--|-----|-----|-----|-------|
| operating temperature | see derating curves | -40 | | 85 | °C |
| storage temperature | | -55 | | 125 | °C |
| storage humidity | non-condensing | 5 | | 95 | % |
| vibration | 10~150 Hz, for 90 minutes on each axis | | 5 | | G |

DERATING CURVES

Temperature Derating Curve
(Output Load vs. Ambient Temperature
20 LFM, 5 Vdc output models)

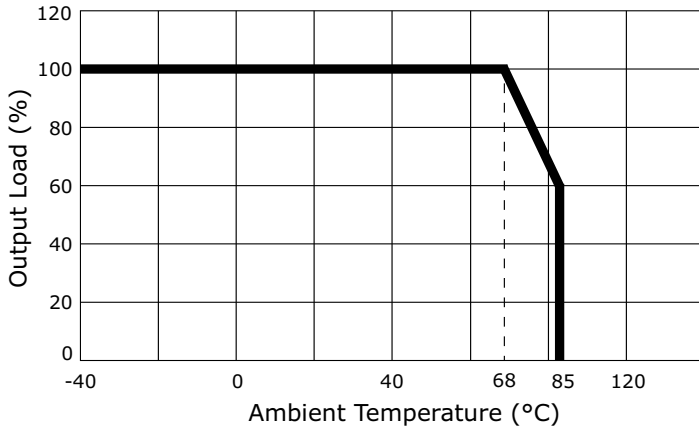

Temperature Derating Curve
(Output Load vs. Ambient Temperature
20 LFM, all other models)

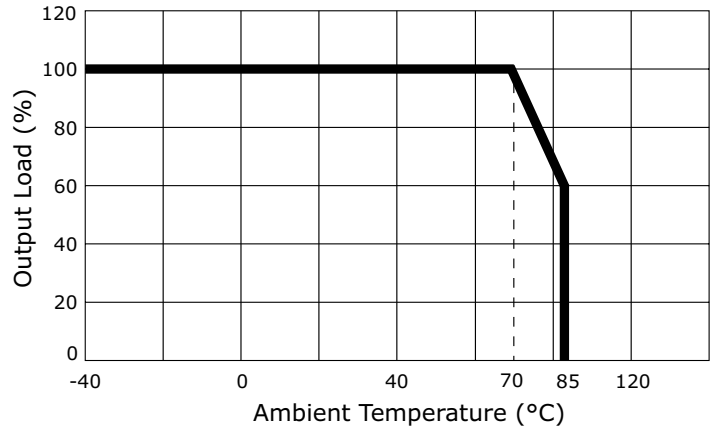

SOLDERABILITY

| parameter | conditions/description | min | typ | max | units |
|--------------------------------|---|-----|-----|-----|-------|
| hand soldering | 1.5 mm from case for 10 seconds | | | 300 | °C |
| wave soldering ⁹ | see wave soldering profile | | | 260 | °C |
| reflow soldering ¹⁰ | see reflow soldering profile Maximum duration >217°C is 60 seconds. For actual application, refer to IPC/JEDEC J-STD-020D.1 | | | 245 | °C |

Note: 9. For DIP models only.
10. For SMT models only.

Wave Soldering Profile
(DIP models)

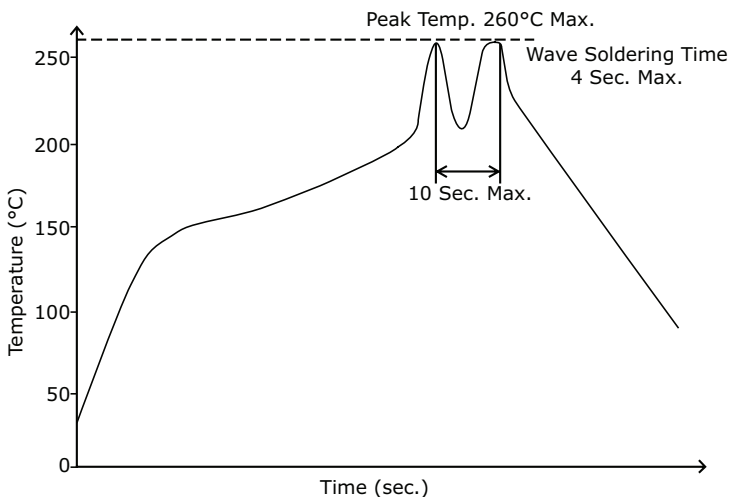

Reflow Soldering Profile
(SMT models)

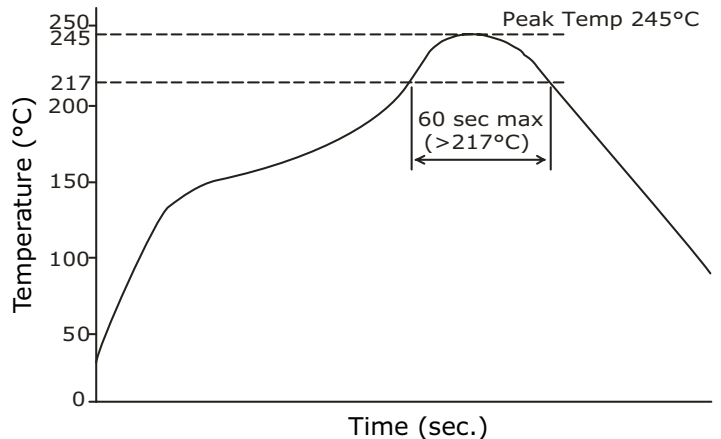

MECHANICAL

| parameter | conditions/description | min | typ | max | units |
|---------------|---|-----|-----|-----|-------|
| dimensions | DIP without case: 39.20 x 20.80 x 6.10 [1.543 x 0.819 x 0.240 inch] | | | | mm |
| | DIP with case: 40.20 x 22.00 x 6.80 [1.583 x 0.866 x 0.268 inch] | | | | mm |
| | SMT without case: 39.20 x 20.80 x 6.30 [1.543 x 0.819 x 0.248 inch] | | | | mm |
| | SMT with case: 40.20 x 22.00 x 7.00 [1.583 x 0.866 x 0.276 inch] | | | | mm |
| case material | aluminum alloy | | | | |
| weight | models without case | | 5.7 | | g |
| | models with case | | 6.7 | | g |

MECHANICAL DRAWING (DIP WITHOUT CASE)

units: mm [inch]
 tolerance: $\pm 0.50[\pm 0.020]$
 pin section tolerance: $\pm 0.10[\pm 0.004]$

| PIN CONNECTIONS | |
|-----------------|----------|
| PIN | Function |
| 1 | Vin |
| 2 | CTRL |
| 3 | GND |
| 4 | 0V |
| 5 | trim |
| 6 | +Vo |

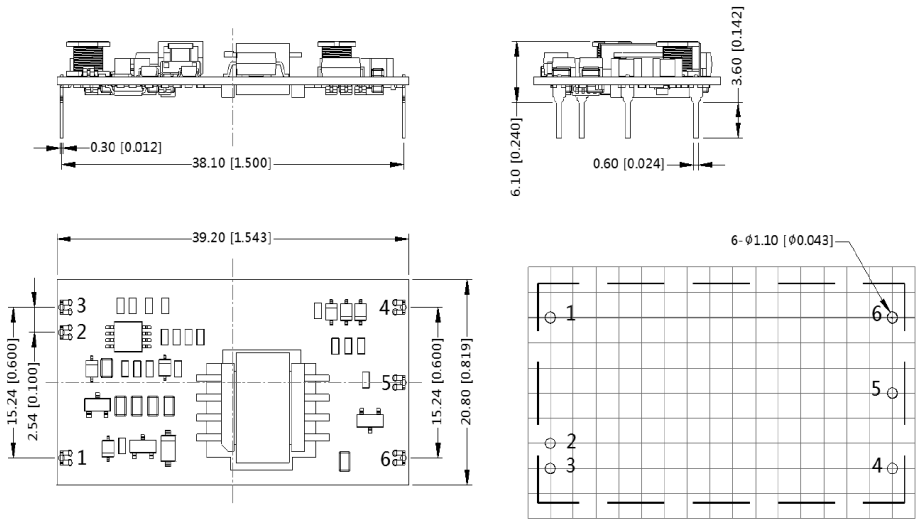

Note: Grid 2.54*2.54mm
 Recommended PCB Layout
 Top View

MECHANICAL DRAWING (DIP WITH CASE)

units: mm [inch]
 tolerance: $\pm 0.50[\pm 0.020]$
 pin section tolerance: $\pm 0.10[\pm 0.004]$

| PIN CONNECTIONS | |
|-----------------|----------|
| PIN | Function |
| 1 | Vin |
| 2 | CTRL |
| 3 | GND |
| 4 | 0V |
| 5 | trim |
| 6 | +Vo |

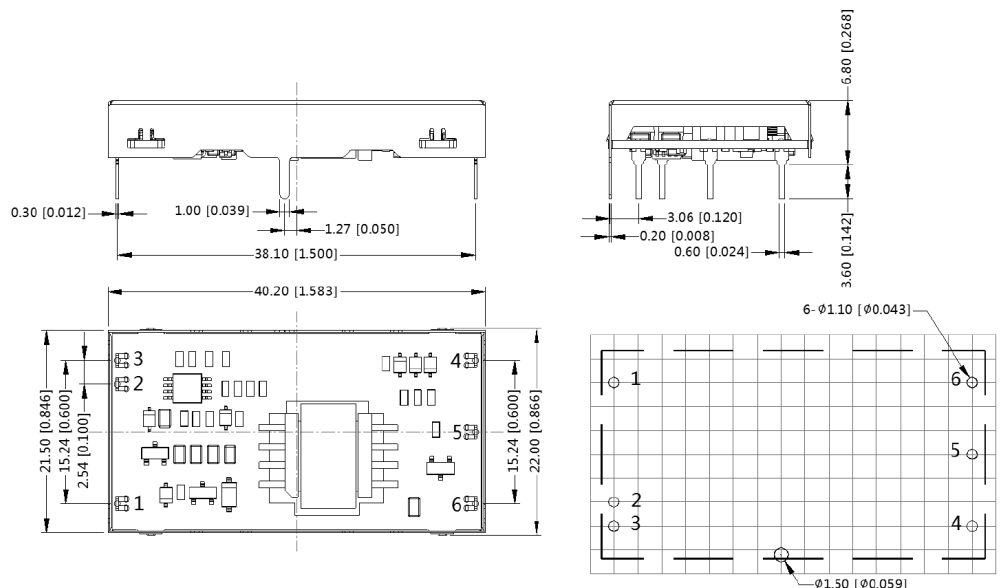

Note: Grid 2.54*2.54mm
 Recommended PCB Layout
 Top View

MECHANICAL DRAWING (SMT WITHOUT CASE)

units: mm [inch]
 tolerance: $\pm 0.50[\pm 0.020]$
 pin section tolerance: $\pm 0.10[\pm 0.004]$

| PIN CONNECTIONS | |
|-----------------|----------|
| PIN | Function |
| 1 | Vin |
| 2 | CTRL |
| 3 | GND |
| 4 | 0V |
| 5 | trim |
| 6 | +Vo |

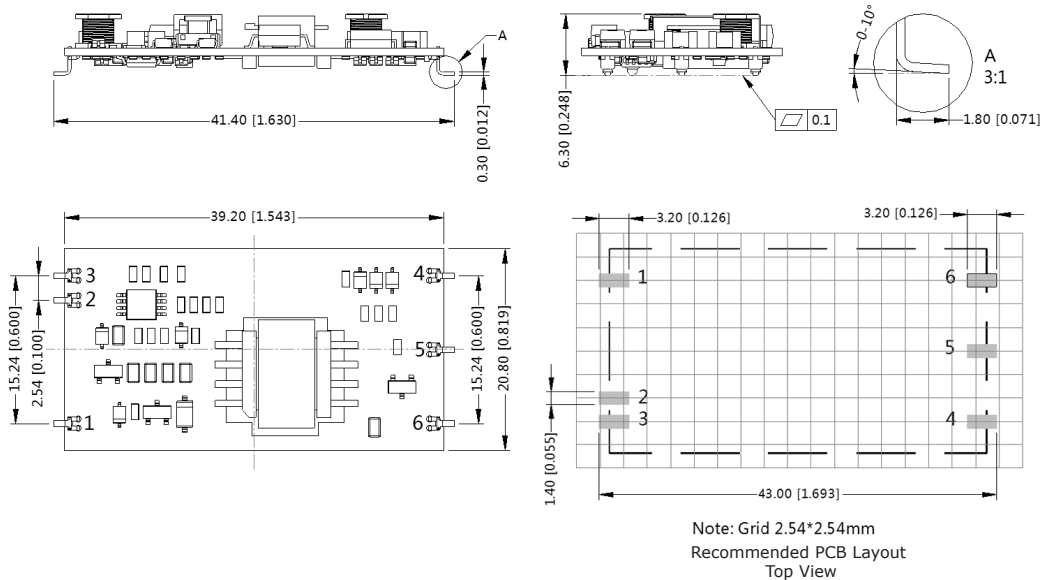

MECHANICAL DRAWING (SMT WITH CASE)

units: mm [inch]
 tolerance: $\pm 0.50[\pm 0.020]$
 pin section tolerance: $\pm 0.10[\pm 0.004]$

| PIN CONNECTIONS | |
|-----------------|----------|
| PIN | Function |
| 1 | Vin |
| 2 | CTRL |
| 3 | GND |
| 4 | 0V |
| 5 | trim |
| 6 | +Vo |

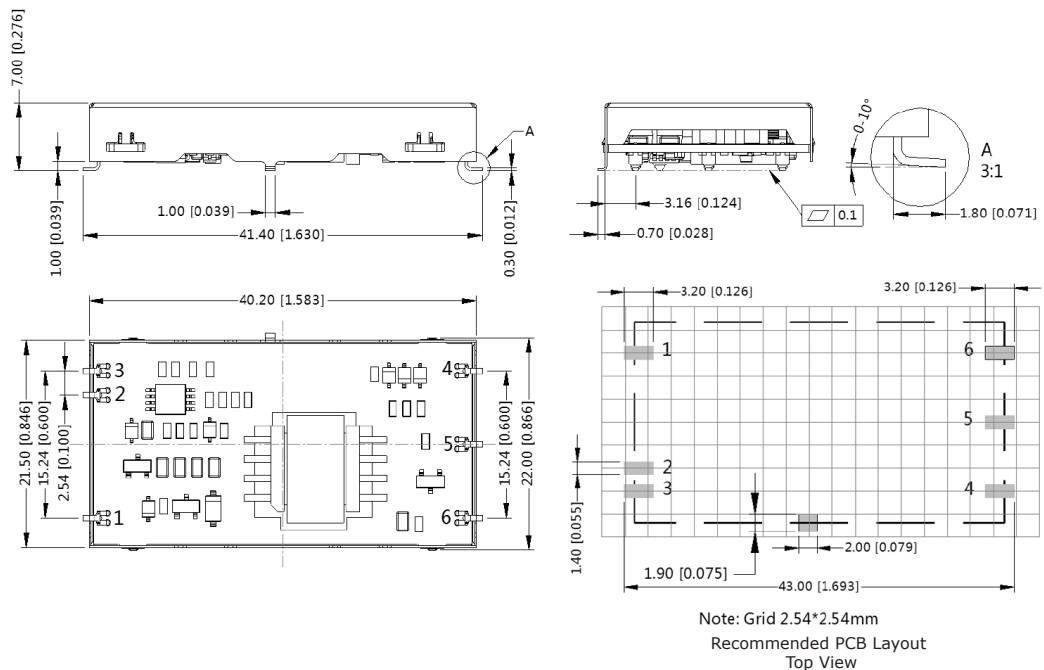

APPLICATION CIRCUIT

This series has been tested according to the following recommended circuit (Figure 1) before leaving the factory. If you want to further reduce the input and output ripple, you can increase the input and output capacitors or select capacitors of low equivalent impedance provided that the capacitance is less than the maximum capacitive load of the model.

Figure 1



Table 1

| Vout (Vdc) | Cin (μF) | Cout (μF) |
|------------|----------|-----------|
| 5/12/15 | 10 | 100 |

EMC RECOMMENDED CIRCUIT

Figure 2

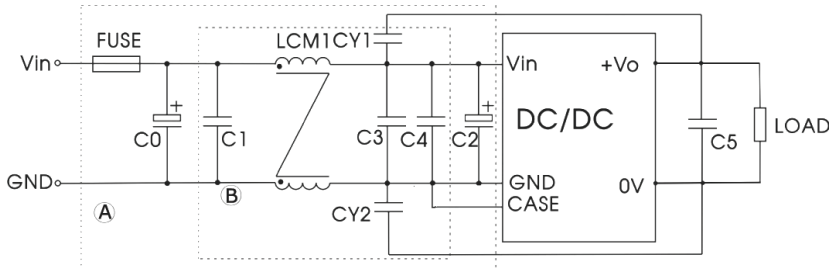

Table 2

| Recommended External Circuit Components | |
|---|--|
| Vin (Vdc) | 24 |
| FUSE | choose according to actual input current |
| C0 | 680 μF / 100 V |
| C1, C3, C4 | 4.7 μF / 50 V |
| C2 | 470 μF / 100 V |
| C5 | 10 μF / 25 V |
| LCM | 3.3 mH |
| CY1, CY2 | 1000 pF / 2 kV |

APPLICATION NOTES

Output voltage trimming
Leave open if not used.

Figure 3

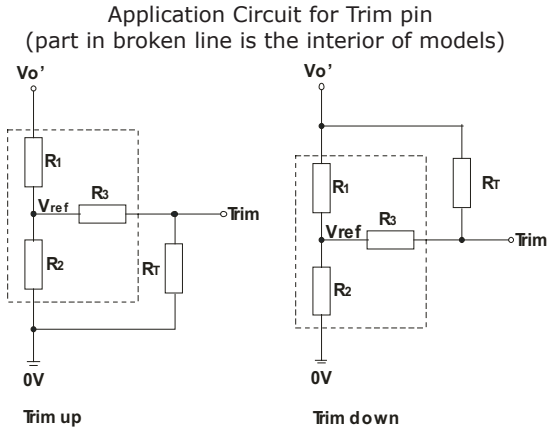

Formula for Trim Resistor

$$\text{up: } R_T = \frac{aR_2}{R_2 - a} - R_3 \quad a = \frac{V_{ref}}{V_{o'} - V_{ref}} \cdot R_1$$

$$\text{down: } R_T = \frac{aR_1}{R_1 - a} - R_3 \quad a = \frac{V_{o'} - V_{ref}}{V_{ref}} \cdot R_2$$

Note: Value for R1, R2, R3, and Vref refer to Table 3
 R_T : Trim Resistor
 a: User-defined parameter, no actual meanings
 $V_{o'}$: The trim up/down voltage

Table 3

| Vout (Vdc) | R1 (kΩ) | R2 (kΩ) | R3 (kΩ) | Vref (V) |
|------------|---------|---------|---------|----------|
| 5 | 2.94 | 2.87 | 15 | 2.5 |
| 12 | 11.00 | 2.87 | 17.4 | 2.5 |
| 15 | 14.50 | 2.87 | 15 | 2.5 |

PACKAGING

units: mm

Inner Carton Size: 292 x 135 x 100 mm

Outer Carton Size: 610 x 285 x 125 mm

Outer Carton QTY: 200 pcs

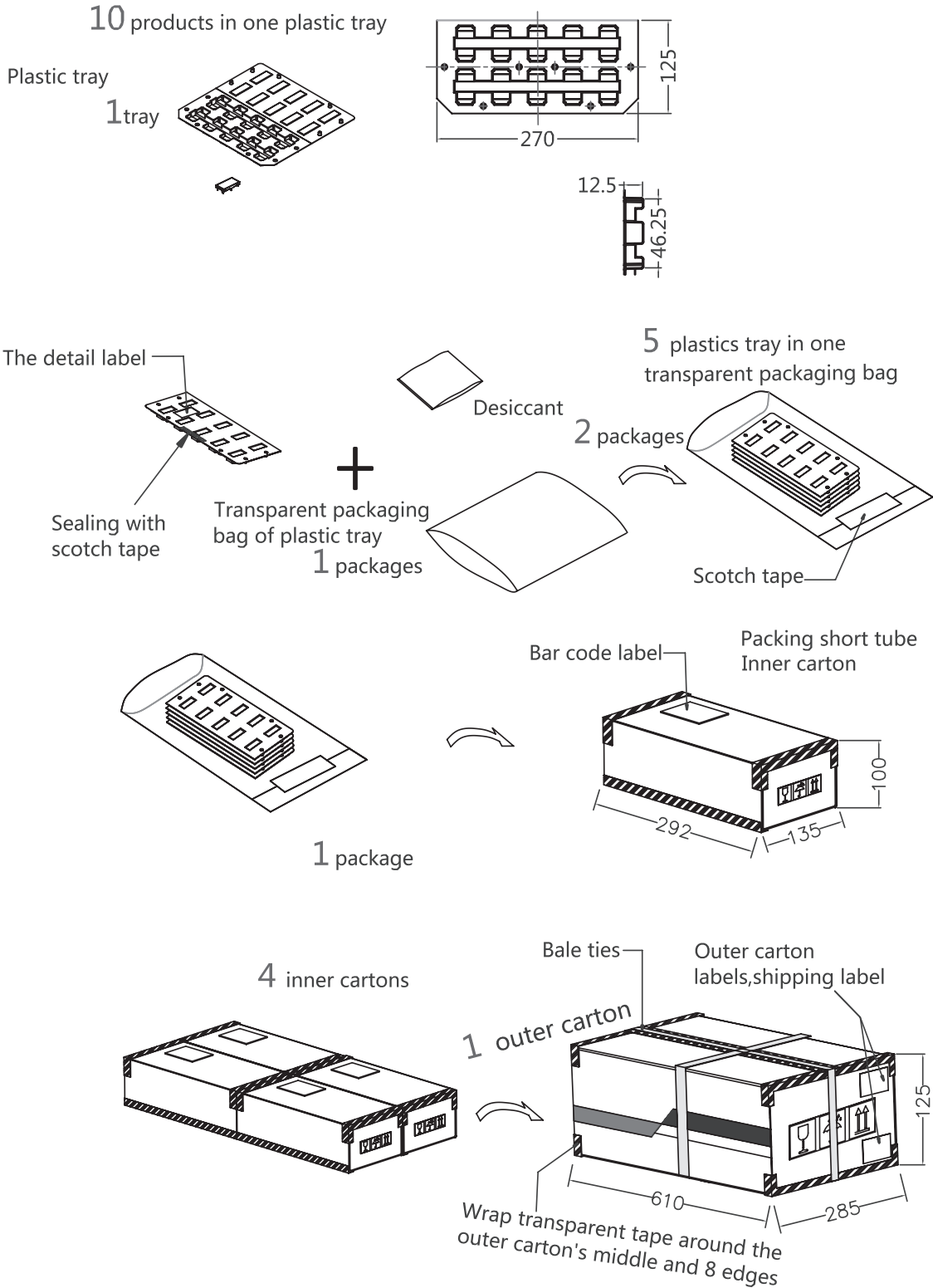

REVISION HISTORY

| rev. | description | date |
|------|-----------------|------------|
| 1.0 | initial release | 03/27/2019 |

The revision history provided is for informational purposes only and is believed to be accurate.



Headquarters
20050 SW 112th Ave.
Tualatin, OR 97062
800.275.4899

Fax 503.612.2383
cui.com
techsupport@cui.com

CUI offers a two (2) year limited warranty. Complete warranty information is listed on our website.

CUI reserves the right to make changes to the product at any time without notice. Information provided by CUI is believed to be accurate and reliable. However, no responsibility is assumed by CUI for its use, nor for any infringements of patents or other rights of third parties which may result from its use.

CUI products are not authorized or warranted for use as critical components in equipment that requires an extremely high level of reliability. A critical component is any component of a life support device or system whose failure to perform can be reasonably expected to cause the failure of the life support device or system, or to affect its safety or effectiveness.

Mouser Electronics

Authorized Distributor

Click to View Pricing, Inventory, Delivery & Lifecycle Information:

[CUI Inc.:](#)

[PYBJ10-Q24-S5-M](#) [PYBJ10-Q24-S12-M](#) [PYBJ10-Q24-S15-M](#)