

SERIES: PQA100-0 | **DESCRIPTION:** DC-DC CONVERTER

FEATURES

- 100 W isolated output
- industry standard DOSA 1/8 brick
- 2:1 input range (36 ~75 Vdc)
- -40 ~ 100°C operating temperature with derating
- over-current, input under-voltage, over-voltage and output short-circuit protection
- remote on/off control
- EN/BS EN 62368 certified



MODEL	input voltage		output voltage	output current		output power	ripple and noise ¹	efficiency ²
	typ (Vdc)	range (Vdc)	(Vdc)	min (A)	max (A)	max (W)	max (mVp-p)	typ (%)
PQA100-48-S5-O	48	36~75	5	0	20.0	100	150	92
PQA100-48-S12-O	48	36~75	12	0	8.3	100	150	93
PQA100-48-S15-O	48	36~75	15	0	6.67	100	150	93
PQA100-48-S24-O	48	36~75	24	0	4.17	100	150	92
PQA100-48-S28-O	48	36~75	28	0	3.57	100	150	92

- Notes:
1. Ripple and noise are measured at 20 MHz BW by "tip and barrel" method, nominal input & 5%~100% load. Ripple and noise at <5% load is 5% Vo max.
 2. Efficiency is measured in nominal input voltage and rated output load.
 3. Unless otherwise specified, parameters in this datasheet were measured under the conditions of Ta=25°C, humidity<75%RH with nominal input voltage and rated output load.
 4. The products do not support parallel connection of their output.

PART NUMBER KEY

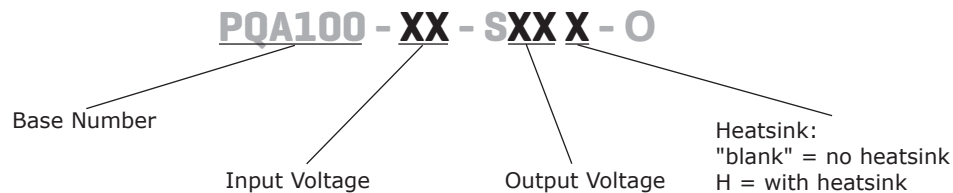

INPUT

parameter	conditions/description	min	typ	max	units
input voltage		36	48	75	Vdc
current (full load/no load)			2264/20	2315/30	mA
reflected ripple current			30	100	mA
start-up voltage				36	Vdc
start-up current				5	A
under voltage protection		26	29		Vdc
surge voltage	for maximum of 1 second	-0.7		80	Vdc
start-up time	nominal input, constant load			100	ms
CTRL ⁵	models ON (CTRL pin open or pulled high, 3.5~12 Vdc)				
	models OFF (CTRL pin pulled low to GND, 0~1.2 Vdc)				
	input current (models OFF)		3	10	mA
filter	pi filter				

Note 5. CTRL pin voltage is referenced to GND.

OUTPUT

parameter	conditions/description	min	typ	max	units
maximum capacitive load	5 Vdc output model			6,000	μF
	12 & 15 Vdc output model			2,000	μF
	24 & 28 Vdc output model			1,000	μF
line regulation	full load, input voltage from low to high		±0.2	±0.5	%
load regulation	5% to 100% load		±0.5	±0.75	%
voltage accuracy	0% to 100% load		±1	±3	%
switching frequency	PWM mode		200		kHz
transient recovery time	25% load step change		300	500	μs
transient response deviation	25% load step change		±5	±8	%
	5 Vdc output models other output models		±3	±5	%
temperature coefficient	at full load			±0.03	%/°C
trim		90		110	%
sense				105	%

PROTECTIONS

parameter	conditions/description	min	typ	max	units
over voltage protection		110		160	%
over current protection		110	140	190	%
short circuit protection	continuous, auto recovery				
over temperature protection	product surface max. temperature (see Fig. 6)		130		°C

SAFETY AND COMPLIANCE

parameter	conditions/description	min	typ	max	units
isolation voltage	input to output for 1 minute, 1 mA max	1,500			Vdc
isolation resistance	input to output at 500 Vdc	1,000			MΩ
isolation capacitance	input to output at 100 kHz, 0.1 Vdc		1,000		pF
safety approvals	certified to 62368: IEC, EN				
conducted emissions	CISPR32/EN55032 CLASS A (see Fig. 3 for recommended circuit) CISPR32/EN55032 CLASS B (see Fig. 4 for recommended circuit)				
radiated emissions	CISPR32/EN55032 CLASS A (see Fig. 3 for recommended circuit) CISPR32/EN55032 CLASS B (see Fig. 4 for recommended circuit)				
ESD	IEC/EN61000-4-2 Contact ±6KV, perf. Criteria B				
radiated immunity	IEC/EN61000-4-3 10V/m, perf. Criteria A				
EFT/burst	IEC/EN61000-4-4 ±2KV, perf. Criteria B				
surge	IEC/EN61000-4-5 line to line ±2KV, perf. Criteria B				
conducted immunity	IEC/EN61000-4-6 3 Vrms, perf. Criteria A				
MTBF	as per MIL-HDBK-217F at 25°C	500,000			hours
RoHS	yes				

ENVIRONMENTAL

parameter	conditions/description	min	typ	max	units
operating temperature	see derating curve	-40		100	°C
storage temperature		-55		125	°C
storage humidity	non-condensing	5		95	%
vibration	10 ~ 55Hz, 30Min. along X, Y and Z			10	G
altitude	atmospheric pressure: 80~110KPa			2,000	m

SOLDERING

parameter	conditions/description	min	typ	max	units
pin soldering resistance	wave soldering, 10 seconds			260	°C
	soldering spot is 1.5mm away from case for 10 seconds			300	°C

MECHANICAL

parameter	conditions/description	min	typ	max	units
dimensions	without heatsink: 58.42 x 22.86 x 9.69 [2.300 x 0.900 x 0.381 inch]				mm
	with heatsink: 58.42 x 22.86 x 12.7 [2.300 x 0.900 x 0.500 inch]				mm
weight	without heatsink		27.0		g
	with heatsink		35.9		g
cooling	natural convection or forced air				

MECHANICAL DRAWING

units: mm[inch]

pin diameter tolerance: $\pm 0.10[\pm 0.004]$

general tolerance: $\pm 0.50[\pm 0.020]$

pin 1,2,3,5,6,7: $\varnothing 1.0$ mm

pin 4,8: $\varnothing 1.5$ mm

PIN CONNECTIONS	
PIN	Function
1	+Vin
2	CTRL
3	-Vin
4	0V
5	-sense
6	Trim
7	+sense
8	+Vo

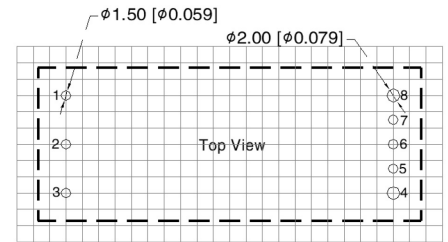
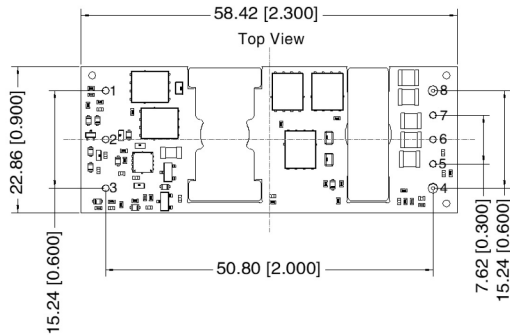

Note: Grid 2.54*2.54mm

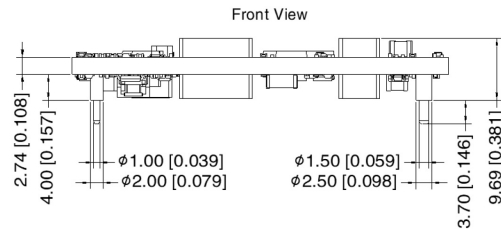

WITH HEATSINK

units: mm[inch]

pin diameter tolerance: $\pm 0.10[\pm 0.004]$

general tolerance: $\pm 0.50[\pm 0.020]$

pin 1,2,3,5,6,7: $\varnothing 1.0$ mm

pin 4,8: $\varnothing 1.5$ mm

PIN CONNECTIONS	
PIN	Function
1	+Vin
2	CTRL
3	-Vin
4	0V
5	-sense
6	Trim
7	+sense
8	+Vo

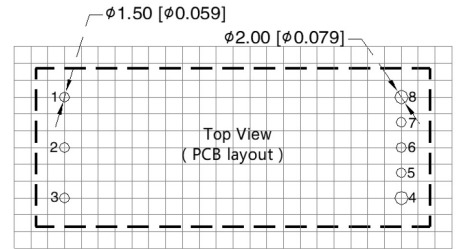
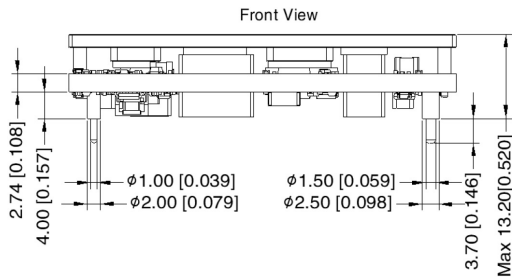

Note: Grid 2.54*2.54mm

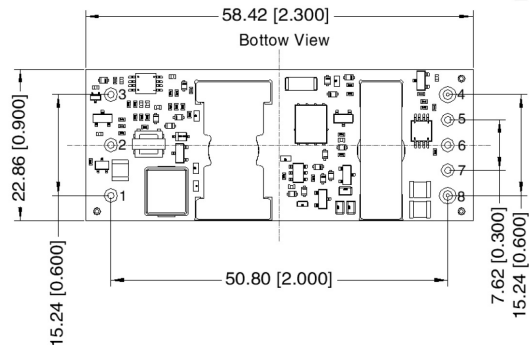

DERATING CURVES

TEMPERATURE DERATING CURVE
($V_{in} = 48V$)
PQA100-48-S5-O

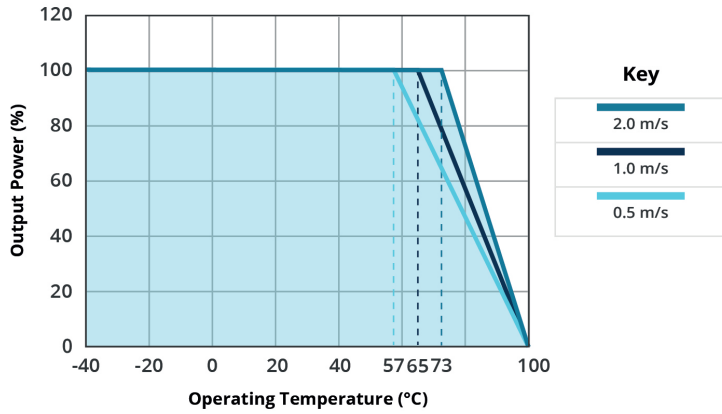

TEMPERATURE DERATING CURVE
($V_{in} = 48V$)
PQA100-48-S12-O

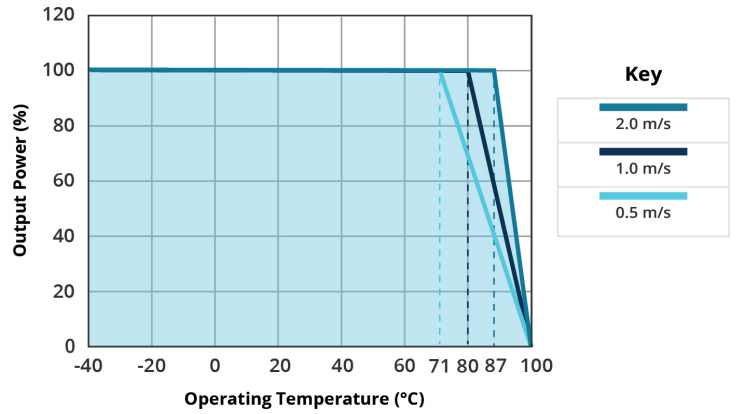

TEMPERATURE DERATING CURVE
($V_{in} = 48V$)
PQA100-48-S15-O

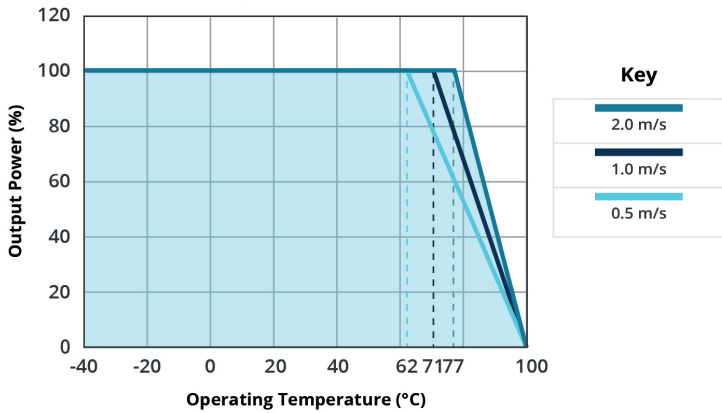

TEMPERATURE DERATING CURVE
($V_{in} = 48V$)
PQA100-48-S24-O

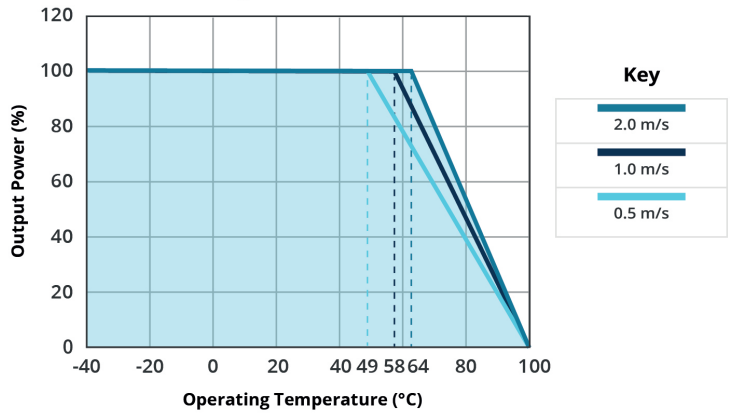

TEMPERATURE DERATING CURVE
($V_{in} = 48V$)
PQA100-48-S28-O

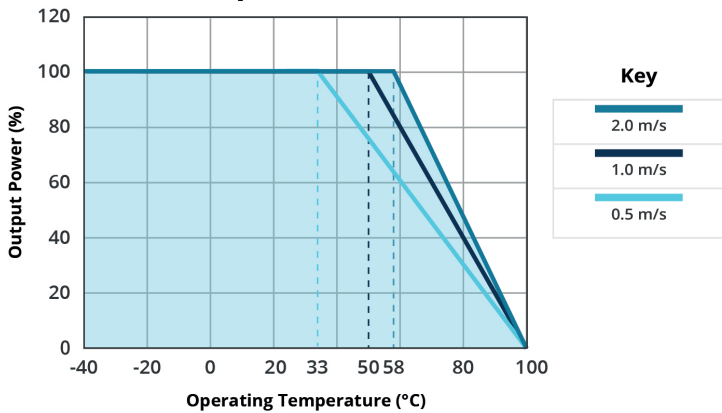

DERATING CURVES (CONTINUED)

TEMPERATURE DERATING CURVE
PQA100-48-S24H-O

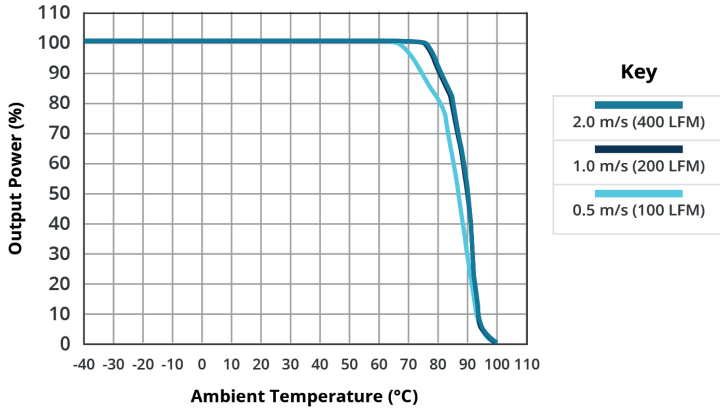

TEMPERATURE DERATING CURVE
PQA100-48-S15H-O

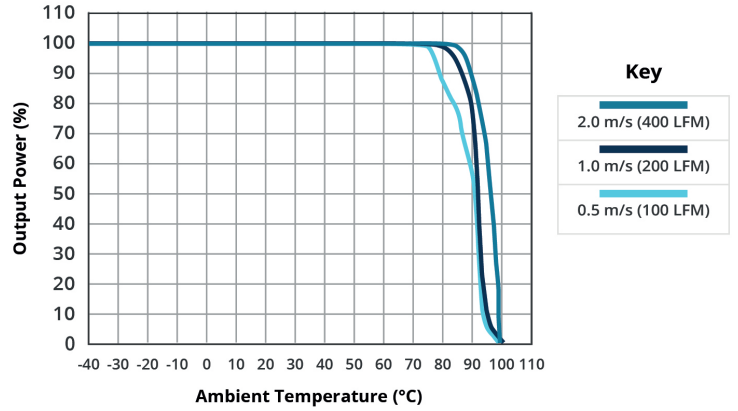

TEMPERATURE DERATING CURVE
PQA100-48-S28H-O

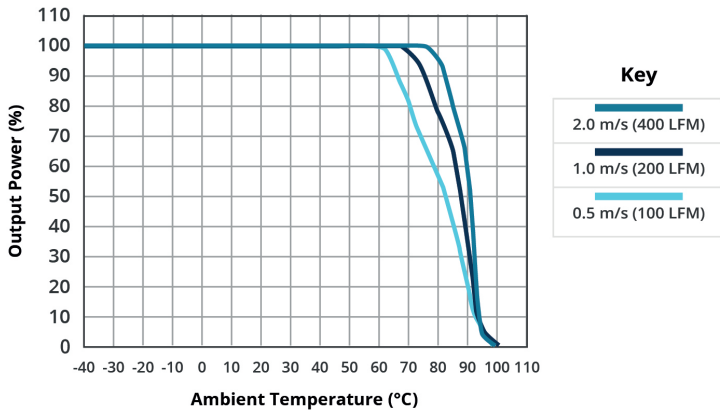

EFFICIENCY CURVES

EFFICIENCY VS INPUT VOLTAGE
full load
PQA100-48-S5-O

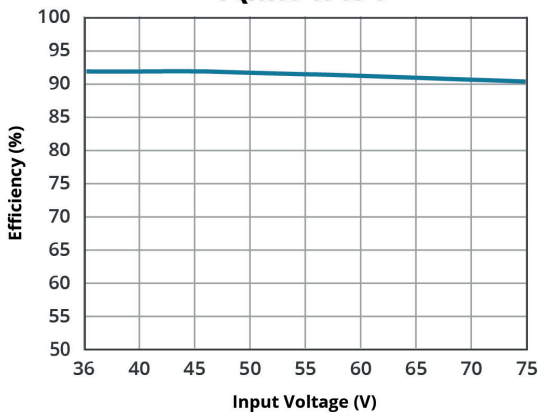

EFFICIENCY VS OUTPUT LOAD
(Vin = 48V)
PQA100-48-S5-O

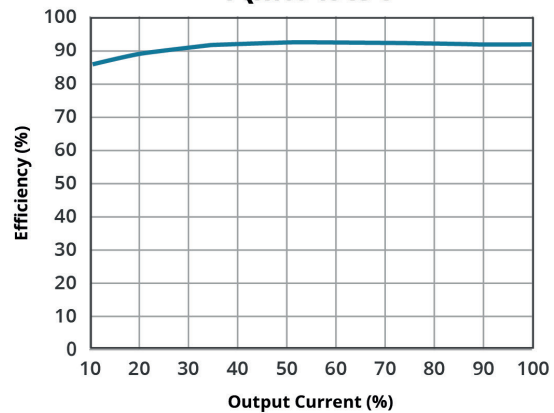

RIPPLE AND NOISE

All the DC-DC converters of this series are tested before delivery using the recommended circuit shown in Figure 1.

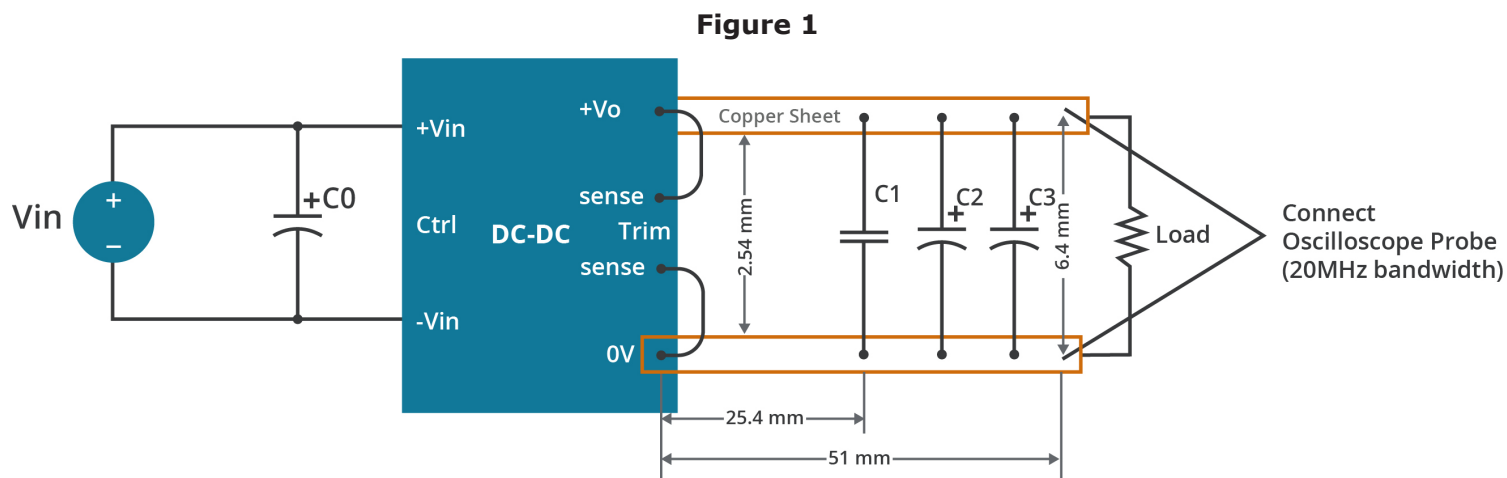

Table 1

Capacitor value Output voltage	C0	C1	C2	C3
5 Vdc	100 μ F/100V	1 μ F/50V	10 μ F/50V	330 μ F/63V
12 Vdc				
15 Vdc				
24 Vdc				
28 Vdc				

APPLICATION DESIGN REFERENCE

It is recommended to use CUI's EMC circuit, otherwise please ensure that at least a 100 μ F electrolytic capacitors is connected at the input in order to ensure adequate voltage surge suppression and protection.

Input and/or output ripple can be further reduced by appropriately increasing the input & output capacitor values C_{in} and C_{out} and/or by selecting capacitors with a low ESR (equivalent series resistance). Also make sure that the capacitance is not exceeding the specified max. capacitive load value of the product.

Figure 2

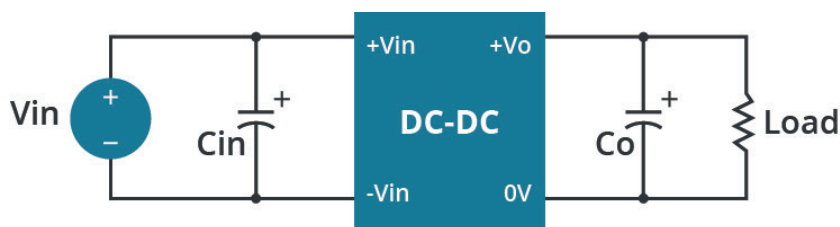

Table 2

Capacitor value Output voltage	C_{in}	C_{out}
5 Vdc	100 μ F/100V	330 μ F/63V
12 Vdc		
15 Vdc		
24 Vdc		
28 Vdc		

EMC RECOMMENDED CIRCUIT

Figure 3

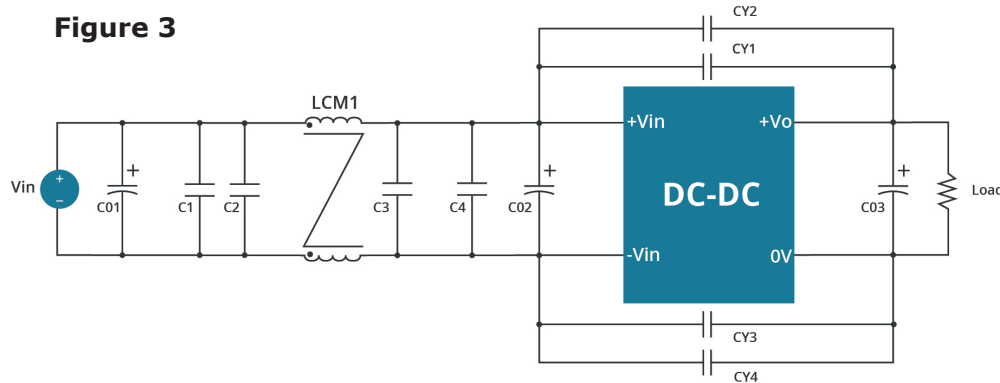

Table 3

MODEL	Vin
C01	470 μ F/100V (electrolytic capacitor)
C02	100 μ F/100V (electrolytic capacitor)
C03	330 μ F/63V (electrolytic capacitor)
C1, C2, C3, C4	4.7 μ F/100V
CY1, CY2, CY3, CY4	2.2 μ F/2KV
LCM1	2mH

Figure 4

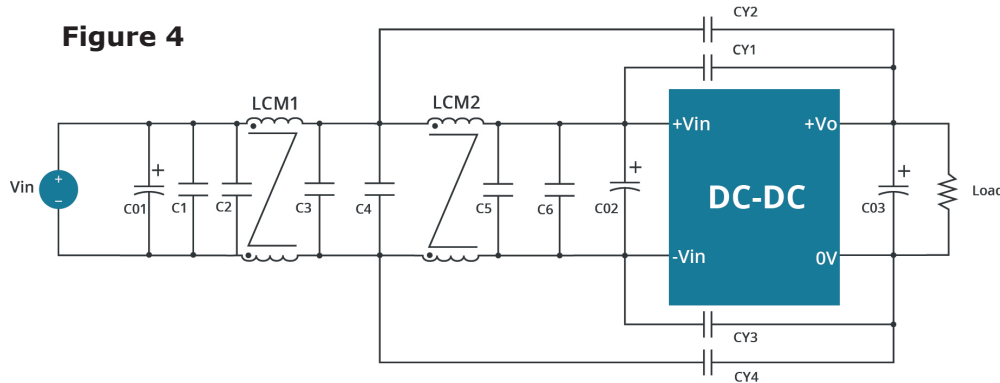

Table 4

MODEL	Vin
C01	470 μ F/100V (electrolytic capacitor)
C02	100 μ F/100V (electrolytic capacitor)
C03	330 μ F/63V (electrolytic capacitor)
C1, C2, C3, C4, C5, C6	4.7 μ F/100V
CY1, CY2, CY3, CY4	4.7nF/1.5KV
LCM1, LCM2	2mH

TRIM FUNCTION

TRIM FUNCTION FOR OUTPUT VOLTAGE ADJUSTMENT (OPEN IF UNUSED)

Figure 5

Trim up

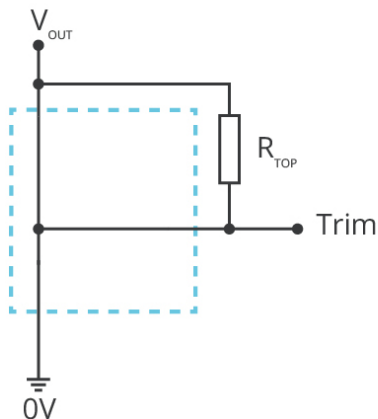

Trim down

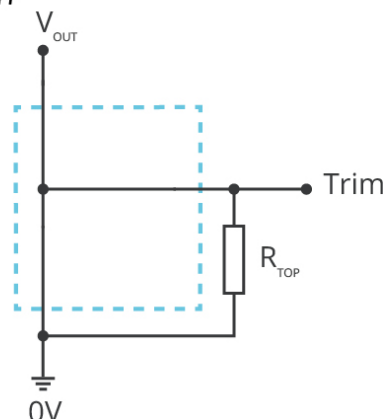

$$R_{\text{TRIM}} = \left(\frac{5.11 V_{\text{NOM}} (100 + \Delta\%) }{1.225 \times \Delta\%} - \frac{511}{\Delta\%} - 10.22 \right) (\text{K } \Omega)$$

When the output voltage is 12V, the up-regulated voltage is +10%, that is, the output voltage set to 13.2V:

$$R_{\text{TRIM}} = \left(\frac{5.11 \times 12 (100 + 10)}{1.225 \times 10} - \frac{511}{10} - 10.22 \right) = 489 (\text{K } \Omega)$$

$$\Delta\% = \left(\frac{12 - 13.2}{12} \right) \times 100 = 10$$

Formula for Trim up

$$R_{\text{TRIM}} = \left(\frac{511}{\Delta\%} \right) - 10.22 (\text{K } \Omega)$$

When the output voltage is 12V, the down-regulated voltage is -10%, that is, the output voltage set to 10.8V:

$$\Delta\% = \left(\frac{12 - 10.8}{12} \right) \times 100 = 10$$

$$R_{\text{TRIM}} = \frac{511}{10} - 10.22 = 40.88 (\text{K } \Omega)$$

Formula for Trim down

$$\Delta\% = \left(\frac{V_{\text{NOM}} - V_{\text{OUT}}}{V_{\text{NOM}}} \right) \times 100$$

Note: R_{TRIM} : Trim resistance
 V_{NOM} : Nominal output voltage
 V_{OUT} : Desired output voltage

HOT TEST POINT

The thermal element is installed on the top surface of the product and dissipates heat to the surrounding environment through conduction, convection, and radiation. Sufficient heat dissipation conditions should be provided to ensure the reliable operation of the product.

By measuring the temperature of the thermal test point (see Fig. 6), it can be verified whether the heat dissipation conditions are met.

Figure 6

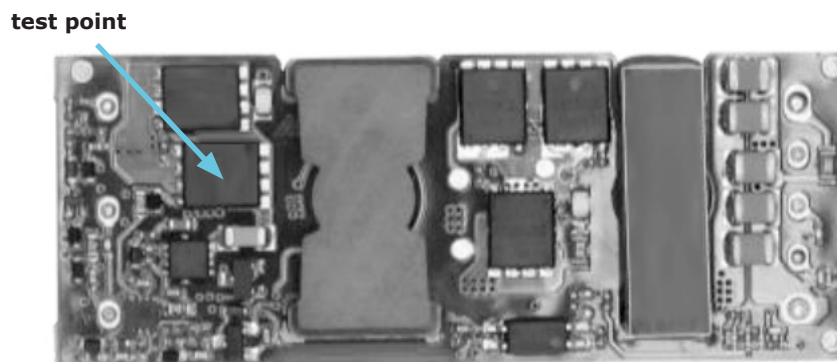

Note: The temperature of the hot test point cannot exceed 130°C, otherwise the product will trigger protection due to excessive temperature and cannot work normally.

REMOTE SENSE APPLICATION

Figure 7

REMOTE SENSE CONNECTION IF NOT USED

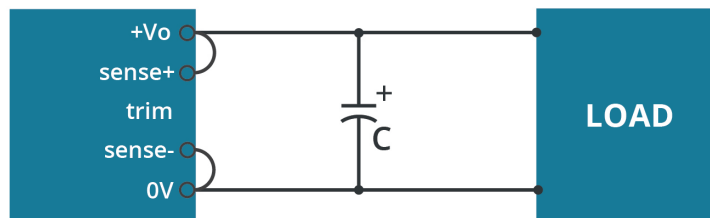

- Note:
1. Lines must be kept as short as possible.
 2. If the sense function is not used for remote regulation the user must connect the +Sense to + Vo and -Sense to 0V at the DC-DC converter pins and will compensate for voltage drop across pins only.
 3. The connections between Sense lines and their respective power lines must be kept as short as possible, otherwise they may be picking up noise, interference and/or causing unstable operation of the power module.

Figure 8

REMOTE SENSE CONNECTION USED FOR COMPENSATION

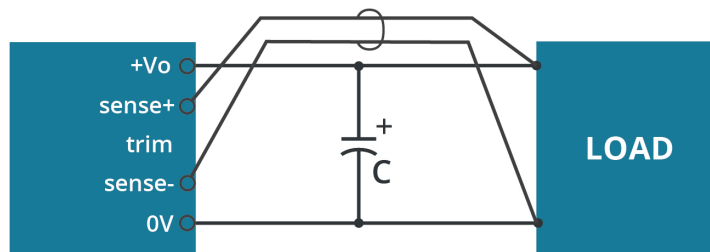

- Note:
1. In cables and discrete wiring applications, twisted pair or other techniques should be implemented.
 2. Using remote sense with long wires may cause unstable output, please contact technical support if long wires must be used.
 3. PCB-tracks or cables/wires for Remote Sense must be kept as short as possible. Twisted pair or shielded wairs are suggested for remote compensation and must be kept as short as possible.
 4. We recommend using adequate cross section for PCB-track layout and/or cables to connect the power supply module to the load in order to keep the voltage drop below 0.3V and to make sure the power supply's output voltage remains within the specified range.
 5. Note that large wire impedance may cause oscillation of the output voltage and/or increased ripple. Consult technical support or factory for further advice of sense operation.

REVISION HISTORY

rev.	description	date
1.0	initial release	11/30/2023

The revision history provided is for informational purposes only and is believed to be accurate.



CUI INC

a bel group

Headquarters
20050 SW 112th Ave.
Tualatin, OR 97062
800.275.4899

Fax 503.612.2383
cui.com
techsupport@cui.com

CUI offers a two (2) year limited warranty. Complete warranty information is listed on our website.

CUI reserves the right to make changes to the product at any time without notice. Information provided by CUI is believed to be accurate and reliable. However, no responsibility is assumed by CUI for its use, nor for any infringements of patents or other rights of third parties which may result from its use.

CUI products are not authorized or warranted for use as critical components in equipment that requires an extremely high level of reliability. A critical component is any component of a life support device or system whose failure to perform can be reasonably expected to cause the failure of the life support device or system, or to affect its safety or effectiveness.