

SUCOFLEX® 500

High performance
up to 70 GHz



SUCOFLEX 500

When it comes to test and measurement, the SUCOFLEX 500 assemblies guarantee the highest level of satisfaction. Thanks to their unique cable and connector design, they deliver the best phase and amplitude stability versus flexure, movement, temperature and tensile stress, in combination with outstanding return and insertion loss up to 70 GHz.

Due to the rotary swaged low-loss inner conductor and the rugged construction, SUCOFLEX 500 assemblies typically withstand more than 100,000 flexures without degradation of performance and therefore have a very long life-time.

HUBER+SUHNER supplies all SUCOFLEX 500 standard length products within five working days and customised lengths are available within ten working days worldwide.



Short delivery time



Outstanding performance



Excellent price-performance ratio

SUCOFLEX 526V

- Consistent electrical performance up to 26.5 GHz
- Best-in-class phase and amplitude stability with flexure, movement, temperature, and tensile stress
- Extremely flexible and simplifies handling and routing



SUCOFLEX 526 E/EA/S, 540 E/EA/S, 550 E/EA/S, 570 E/S

- High electrical performance up to 70 GHz
- Excellent return and insertion loss
- Best-in-class phase and amplitude stability with flexure and movement
- Very long service life (>100.000 flex cycles)
- Variety of interface options available

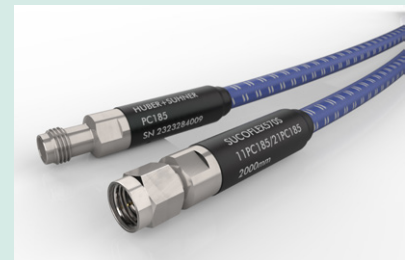

SUCOFLEX 500 Variations



26.5 GHz	SUCOFLEX 526	SUCOFLEX 526E	SUCOFLEX 526EA	SUCOFLEX 526S	SUCOFLEX 526V
40 GHz	SUCOFLEX 540	SUCOFLEX 540E	SUCOFLEX 540EA	SUCOFLEX 540S	
50 GHz	SUCOFLEX 550	SUCOFLEX 550E	SUCOFLEX 550EA	SUCOFLEX 550S	
70 GHz	SUCOFLEX 570	SUCOFLEX 570E		SUCOFLEX 570S	

Applications

- Bench top testing
- RF production testing
- Automated test equipment
- Vector network analyzers (VNAs)
- Scalar analyzers
- Portable test equipment
- RF module testing
- High speed digital testing (HSDT)

SUCOFLEX 526 – 26.5 GHz



Mechanical data

Frequency	26.5 GHz			
	SUCOFLEX 526	SUCOFLEX 526E	SUCOFLEX 526EA	SUCOFLEX 526S
Cable				
Connectors	PC3.5 (3.5 mm), SMA, N			
Diameter (mm)	5.5	5.5	10.3	7.7
Outer jacket material	FEP	PUR	PUR	PTFE
Crush resistant	No	No	Yes	Yes
Min. bending radius (mm)	16	16	30	25.4
Typ. flex life (cycles)	> 100'000			
Min. assembly length (mm)	300			
Max. assembly length (mm)	50,000	50,000	40,000	50,000

Environmental data

Operating temperature (°C)	-55 to +125°C	-40 to +85°C	-40 to +85°C	-55 to +125°C
2011/65/EC (RoHS)	compliant			
2006/1907/EC (REACH)	compliant			
2012/19/EU (WEEE)	relevant			

Electrical data

Impedance (Ω)	50			
Velocity of propagation (%)	77			
Typ. return loss (dB)	25			
Min. return loss (dB)	19 (up to 18 GHz) 16.6 (up to 26.5 GHz)			
Typ. insertion loss assembly (dB/m)	1.63			
Max. insertion loss assembly (dB/m)	1.77			
Min. screening effectiveness (dB) up to 18 GHz	90			
Typ. amplitude stability vs. movement (dB)	± 0.1	± 0.1	± 0.1	± 0.05
Typ. amplitude stability vs. flexure (dB)	± 0.1	± 0.1	± 0.1	± 0.05
Typ. phase stability vs. bending (°)	±8	±8	±8	± 3
Relative and absolute time delay matching: ±1 ps	available on request			

SUCOFLEX 526 stock assemblies

Art. No	Type	Connector 1	Connector 2	Length (mm)	Length (inch)	Frequency (GHz)	max. IL (dB)	min. RL (dB)
85207923	SF526E/11PC35/11PC35/24in	3.5mm male	3.5mm male	610	24	26.5	1.18	16.6
85207924	SF526E/11PC35/11PC35/36in	3.5mm male	3.5mm male	914	36	26.5	1.64	16.6
85154814	SF526S/11PC35/11PC35/24in	3.5mm male	3.5mm male	610	24	26.5	1.18	16.6
85088164	SF526S/11PC35/11PC35/36in	3.5mm male	3.5mm male	914	36	26.5	1.64	16.6
85092086	SF526S/11PC35/11PC35/48in	3.5mm male	3.5mm male	1219	48	26.5	2.10	16.6

Absolute time delay matched stock assemblies

Art. No	Cable	Connector 1	Connector 2	Length (mm)	Length (inch)	Frequency (GHz)	max. IL (dB)	min. RL (dB)	Absolute time delay matching
85207925	PMA SF526E/11PC35/11PC35/24in	3.5mm male	3.5mm male	610	24	26.5	1.18	16.6	± 1ps
85207926	PMA SF526E/11PC35/11PC35/36in	3.5mm male	3.5mm male	914	36	26.5	1.64	16.6	± 1ps
85185119	PMA SF526S/11PC35/11PC35/24in	3.5mm male	3.5mm male	610	24	26.5	1.18	16.6	± 1ps
85185120	PMA SF526S/11PC35/11PC35/36in	3.5mm male	3.5mm male	914	36	26.5	1.64	16.6	± 1ps

SUCOFLEX 526V – 26.5 GHz

SUCOFLEX 526V

The only VNA microwave cable assembly worldwide with a typical 50 ppm phase variation vs. temperature between +15 and +30 °C. No "PTFE phase knee" at +19 °C as seen on conventional VNA test cable assemblies which cause phase variations and unstable measurements in critical laboratory conditions.



Available assemblies

Product configuration

Art. No.	85069744	85081169	85070046	85081172	85070047	85081177
Cable type	SUCOFLEX 526V					
Length	25" (635 mm)	25" (635 mm)	38" (965 mm)	38" (965 mm)	48" (1219 mm)	48" (1219 mm)
Connector 1	3.5 mm ruggedised PORT female (35VF)					
Connector 2	3.5 mm ruggedised DUT male (35VM)	3.5 mm DUT female (35F)	3.5 mm ruggedised DUT male (35VM)	3.5 mm DUT female (35F)	3.5 mm ruggedised DUT male (35VM)	3.5 mm DUT female (35F)

Mechanical data

Diameter (mm)	13
Min. bending radius (mm)	50
Crush resistance (kN/m)	80
Typ. flex life (cycles)	>100 000 2.0 Mio. for slight movements

Environmental data

Operating temperature	laboratory conditions, analyser specific (+15 to +30 °C)
2011/65/EC (RoHS)	compliant

Electrical data

Art. No.	85069744	85081169	85070046	85081172	85070047	85081177
Impedance (Ω)	50					
Operating frequency (GHz)	up to 26.5					
Velocity of propagation (%)	80					
Time delay (ns/m)	4.15					
Return loss (dB)	typ. 25 min. 20					
Insertion loss (dB)	max. 2.5		max. 3.6		max. 4.4	
Min. screening effectiveness (dB)	> 90					
Amplitude stability vs. movement (dB)	max. 0.05					
Amplitude stability vs. flexure (dB)	max. 0.08					
Phase stability vs. flexure (°)	max. 3.9		max. 7.4		max. 10	
Phase stability vs. tensile stress (°/GHz)	max. 0.1°/GHz (100 N)					
Phase stability vs. temperature (ppm)	typ. 50 (+15 to +30 °C)					

Order information stock assemblies

Art. No.	Description
85069744	SF526V/35VF/35VM/25in
85081169	SF526V/35VF/35F/25in
85070046	SF526V/35VF/35VM/38in
85081172	SF526V/35VF/35F/38in
85070047	SF526V/35VF/35VM/48in
85081177	SF526V/35VF/35F/48in

SUCOFLEX 526V – 26.5 GHz

Phase shift vs. temperature (+15 °C to +30 °C)

		SUCOFLEX 526V	Conventional VNA test lead
Assembly length (in (mm))	Frequency (GHz)*	Phase shift /° (for 50 ppm, 80 % VOP)	Phase shift /° (for 700 ppm, 84 % VOP)
25 (635)	18	0.9	11.4
25 (635)	26.5	1.3	16.7

*Other frequencies on request

Phase stability vs. temperature performance

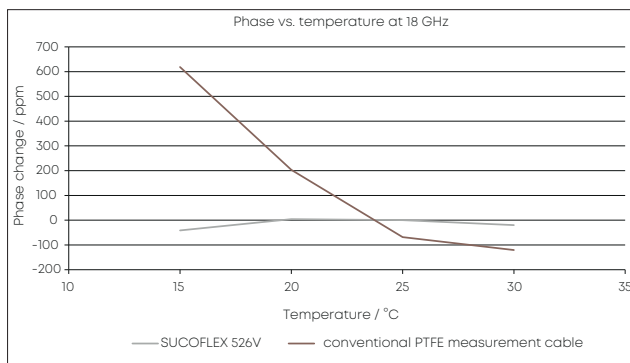

Phase stability vs. flexure

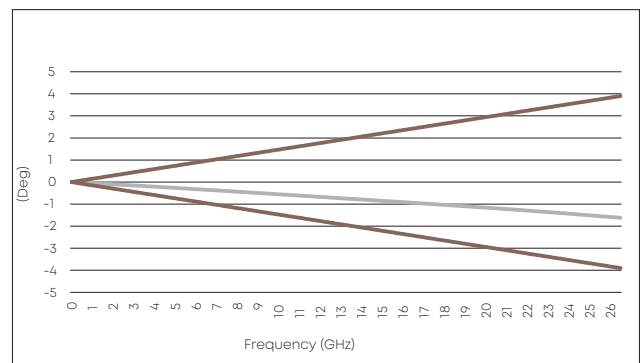

Insertion loss

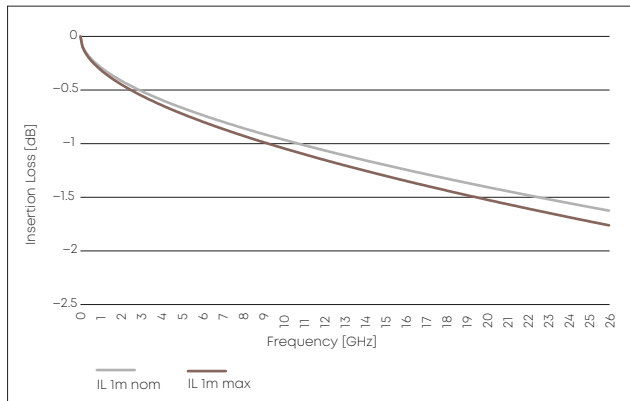

Loss stability vs. flexure

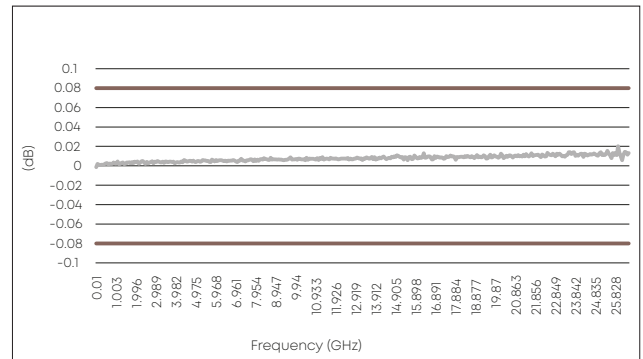

Return loss SUCOFLEX 526V with PC3.5 connectors

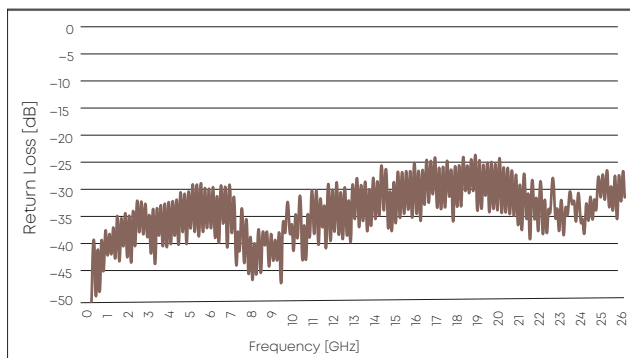

SUCOFLEX 540 – 40 GHz



SUCOFLEX 540S



SUCOFLEX 540

SUCOFLEX 540E

SUCOFLEX 540EA

Mechanical data

Frequency	40 GHz			
Cable	SUCOFLEX 540	SUCOFLEX 540E	SUCOFLEX 540EA	SUCOFLEX 540S
Connector	PC2.4, SK (2.4 mm, 2.92 mm)			
Diameter (mm)	4.0	4.0	7.7	6.4
Outer jacket material	FEP	PUR	PUR	PTFE
Crush resistant	No	No	Yes	Yes
Min. bending radius (mm)	12	12	20	25.4
Typ. flex life (cycles)	> 100'000			
Min. assembly length (mm)	300			
Max. assembly length (mm)	20,000	20,000	20,000	20,000

Environmental data

Operating temperature (°C)	-55 to +125	-40 to +85	-40 to +85	-55 to +125
2011/65/EC (RoHS)	compliant			
2006/1907/EC (REACH)	compliant			
2012/19/EU (WEEE)	relevant			

Electrical data

Impedance (Ω)	50			
Velocity of propagation (%)	77			
Typ. return loss (dB)	17			
Min. return loss (dB)	14.9			
Typ. insertion loss assembly (dB/m)	2.95			
Max. insertion loss assembly (dB/m)	3.21			
Min. screening effectiveness (dB) up to 18 GHz	90			
Typ. amplitude stability vs. movement (dB)	± 0.1	± 0.1	± 0.1	± 0.05
Typ. amplitude stability vs. flexure (dB)	± 0.1	± 0.1	± 0.1	± 0.05
Typ. phase stability vs. flexure (°)	± 8	± 8	± 8	± 5
Relative and absolute time delay matching: ±1 ps	available on request			

SUCOFLEX 540 stock assemblies

Art. No	Type	Connector 1	Connector 2	Length (mm)	Length (inch)	Frequency (GHz)	max. IL (dB)	min. RL (dB)
85207914	SF540E/11SK/11SK/24in	2.92mm male	2.92mm male	610	24	40	2.08	14.9
85207915	SF540E/11SK/11SK/36in	2.92mm male	2.92mm male	914	36	40	2.96	14.9
85207918	SF540S/11SK/11SK/24in	2.92mm male	2.92mm male	610	24	40	2.08	14.9
85207919	SF540S/11SK/11SK/36in	2.92mm male	2.92mm male	914	36	40	2.96	14.9

Absolute time delay matched stock assemblies

Art. No	Cable	Connector 1	Connector 2	Length (mm)	Length (inch)	Frequency (GHz)	max. IL (dB)	min. RL (dB)	Absolute time delay matching
85207916	PMA SF540E/11SK/11SK/24in	2.92mm male	2.92mm male	610	24	40	2.08	14.9	+/- 1ps
85207917	PMA SF540E/11SK/11SK/36in	2.92mm male	2.92mm male	914	36	40	2.96	14.9	+/- 1ps
85207921	PMA SF540S/11SK/11SK/24in	2.92mm male	2.92mm male	610	24	40	2.08	14.9	+/- 1ps
85207922	PMA SF540S/11SK/11SK/36in	2.92mm male	2.92mm male	914	36	40	2.96	14.9	+/- 1ps

SUCOFLEX 550 – 50 GHz



SUCOFLEX 550S



SUCOFLEX 550



SUCOFLEX 550E



SUCOFLEX 550EA

Mechanical data

Frequency	50 GHz			
	SUCOFLEX 550	SUCOFLEX 550E	SUCOFLEX 550EA	SUCOFLEX 550S
Cable	SUCOFLEX 550	SUCOFLEX 550E	SUCOFLEX 550EA	SUCOFLEX 550S
Connector	PC2.4, SK (2.4 mm, 2.92 mm)			
Diameter (mm)	3.7	3.7	7.7	6.1
Outer jacket material	FEP	PUR	PUR	PTFE
Crush resistant	no	no	yes	yes
Min. bending radius (mm)	11	11	20	25.4
Typ. flex life (cycles)	> 100 000			
Min. assembly length (mm)	300			
Max. assembly length (mm)	20 000	20 000	20 000	20 000

Environmental data

Operating temperature (°C)	-55 to +125	-40 to +85	-40 to +85	-55 to +125
2011/65/EC (RoHS)	compliant			
2006/1907/EC (REACH)	compliant			
2012/19/EU (WEEE)	relevant			

Electrical data

Impedance (Ω)	50			
Velocity of propagation (%)	77			
Typ. return loss (dB)	17			
Min. return loss (dB)	14.9			
Typ. insertion loss assembly (dB/m)	3.87			
Max. insertion loss assembly (dB/m)	4.22			
Min. screening effectiveness (dB) up to 18 GHz	90			
Typ. amplitude stability vs. movement (dB)	± 0.1	± 0.1	± 0.1	± 0.05
Typ. amplitude stability vs. flexure (dB)	± 0.1	± 0.1	± 0.1	± 0.05
Typ. phase stability vs. flexure (°)	± 10	± 1.0	± 10	± 6.0
Relative and absolute time delay matching: ± 1 ps	available on request			

SUCOFLEX 550 – 50 GHz

SUCOFLEX 550 stock assemblies

Art. No	Cable	Connector 1	Connector 2	Length (mm)	Length (inch)	Frequency (GHz)	max. IL (dB)	min. RL (dB)
85185826	SF550E/11PC24/11PC24/24in	2.4 mm male	2.4 mm male	610	24	50	2.89	14.9
85157329	SF550E/11PC24/11PC24/36in	2.4 mm male	2.4 mm male	914	36	50	4.07	14.9
85120065	SF550S/11PC24/11PC24/24inch	2.4 mm male	2.4 mm male	610	24	50	2.89	14.9
85120066	SF550S/11PC24/11PC24/36inch	2.4 mm male	2.4 mm male	914	36	50	4.07	14.9
85120068	SF550S/11PC24/11PC24/48inch	2.4 mm male	2.4 mm male	1219	48	50	5.24	14.9

Absolute time delay matched SUCOFLEX 550 stock assemblies

Art. No	Part no.	Connector 1	Connector 2	Length (mm)	Length (inch)	Frequency (GHz)	max. IL (dB)	Min. RL (dB)	Absolute time delay matching
85169945	PMA SF550E/11PC24/11PC24/24in	2.4 mm male	2.4 mm male	610	24	50	2.89	14.9	± 1ps
85169947	PMA SF550E/11PC24/11PC24/36in	2.4 mm male	2.4 mm male	914	36	50	4.07	14.9	± 1ps
85153038	PMA SF550S/11PC24/11PC24/24in	2.4 mm male	2.4 mm male	610	24	50	2.89	14.9	± 1ps
85153039	PMA SF550S/11PC24/11PC24/36in	2.4 mm male	2.4 mm male	914	36	50	4.07	14.9	± 1ps
85185117	PMA SF550S/11SK/11SK/24in	2.92 mm male	2.92 mm male	610	24	40	2.58	14.9	± 1ps
85185118	PMA SF550S/11SK/11SK/36in	2.92 mm male	2.92 mm male	914	36	40	3.61	14.9	± 1ps

SUCOFLEX 570 - 70 GHz

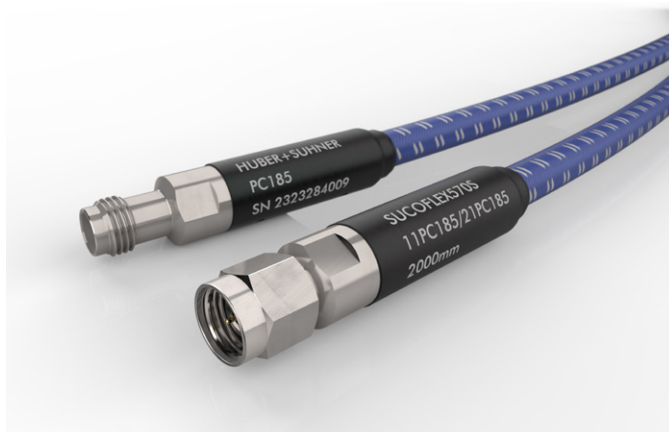

SUCOFLEX 570S



SUCOFLEX 570



SUCOFLEX 570E

Mechanical data

Frequency	70 GHz		
	SUCOFLEX 570	SUCOFLEX 570E	SUCOFLEX 570S
Cable			
Connector	PC1.85 (1.85 mm)		
Diameter (mm)	3,3	3,3	5,8
Outer jacket material	FEP	PUR	PTFE
Crush resistant	no	no	yes
Min. bending Radius (mm)	11	11	25,4
Typ. Flex life (cycles)	> 20'000		
Min. assembly length (mm)	300	300	300
Max. assembly length (mm)	10'000	10'000	10'000

Environmental data

Operating temperature (°C)	-55 to +125	-40 to +85	-55 to +125
2011/65/EC (RoHS)	compliant		
2006/1907/EC (REACH)	compliant		
2012/19/EU (WEEE)	relevant		

Electrical data

Impedance (Ω)	50		
Velocity of propagation (%)	77		
Typ. return loss (dB)	16		
Min. return loss (dB)	14		
Typ. insertion loss assembly (dB/m)	6,48		
Max. insertion loss assembly (dB/m)	7,05		
Min. screening effectiveness (dB) up to 18 GHz	90		
Typ. amplitude stability vs. movement (dB)	± 0,10	± 0,10	± 0,05
Typ. amplitude stability vs. flexure (dB)	± 0,10	± 0,10	± 0,05
Typ. phase stability vs. flexure (°)	± 10	± 10	± 8
Relative and absolute time delay matching (±1ps)	available on request		

SUCOFLEX 570 – 70 GHz

SUCOFLEX 570 stock assemblies

Art. No	Cable	Connector 1	Connector 2	Length (mm)	Length (inch)	Frequency (GHz)	max. IL (dB)	min. RL (dB) @ 67 GHz
85184843	SF570E/11PC185/11PC185/24in	1.85 mm male	1.85 mm male	610	24	70	4.65	14.0
85184844	SF570E/11PC185/11PC185/36in	1.85 mm male	1.85 mm male	914	36	70	6.48	14.0
85186159	SF570S/11PC185/11PC185/24in	1.85 mm male	1.85 mm male	610	24	70	4.65	14.0
85149825	SF570S/11PC185/11PC185/36in	1.85 mm male	1.85 mm male	914	36	70	6.48	14.0
85186160	SF570S/11PC185/11PC185/48in	1.85 mm male	1.85 mm male	1219	48	70	8.50	14.0

Absolute time delay matched SUCOFLEX 570 stock assemblies

Art. No	Part no.	Connector 1	Connector 2	Length (mm)	Length (inch)	Frequency (GHz)	max. IL (dB)	Min. RL (dB) @ 67 GHz	Absolute time delay matching
85184845	PMA SF570E/11PC185/11PC185/24in	1.85 mm male	1.85 mm male	610	24	70	4.65	14.0	± 1ps
85184846	PMA SF570E/11PC185/11PC185/36in	1.85 mm male	1.85 mm male	914	36	70	6.48	14.0	± 1ps
85153051	PMA SF570S/11PC185/11PC185/24in	1.85 mm male	1.85 mm male	610	24	70	4.65	14.0	± 1ps
85153052	PMA SF570S/11PC185/11PC185/36in	1.85 mm male	1.85 mm male	914	36	70	6.48	14.0	± 1ps

SUCOFLEX 500

Available connectors

	Freq. (GHz)	SUCOFLEX 526	SUCOFLEX 526E	SUCOFLEX 526EA	SUCOFLEX 526S	SUCOFLEX 526V
N straight male	18	SF_11_N-503	SF_11_N-504	SF_11_N-505	SF_11_N-501	
N straight female	18	SF_21_N-502	SF_21_N-503	SF_21_N-504	SF_21_N-501	
SMA straight male	18	SF_11_SMA-502	SF_11_SMA-503	SF_11_SMA-504	SF_11_SMA-501	
SMA straight female	18	SF_21_SMA-501	SF_21_SMA-502	SF_21_SMA-503		
3.5mm straight male	26.5	SF_11_PC35-509	SF_11_PC35-510	SF_11_PC35-511	SF_11_PC35-501	
3.5mm straight female	26.5	SF_21_PC35-506	SF_21_PC35-507	SF_21_PC35-508	SF_21_PC35-501	
3.5mm ruggedised PORT female	26.5				SF_21_PC35-502	
3.5mm ruggedised PORT female	26.5					35VF
3.5mm ruggedised DUT male	26.5					35VM
3.5mm DUT female	26.5					35F

Available connectors

	Freq. (GHz)	SUCOFLEX 540	SUCOFLEX 540EA	SUCOFLEX 540E	SUCOFLEX 540S
2.92mm male	40	SF_11_SK-505	SF_11_SK-507	SF_11_SK-506	SF_11_SK-508
2.92mm female	40	SF_21_SK-506	SF_21_SK-508	SF_21_SK-507	SF_21_SK-509
2.92mm ruggedised PORT female	40				
2.4mm male	50	SF_11_PC24-505	SF_11_PC24-507	SF_11_PC24-506	SF_11_PC24-508
2.4mm female	50	SF_21_PC24-506	SF_21_PC24-508	SF_21_PC24-507	SF_21_PC24-509

Available connectors

	Freq. (GHz)	SUCOFLEX 550	SUCOFLEX 550E	SUCOFLEX 550EA	SUCOFLEX 550S
3.5mm straight male	26.5	SF_11_PC35-505	SF_11_PC35-506	SF_11_PC35-507	SF_11_PC35-508
2.92mm male	40	SF_11_SK-502	SF_11_SK-503	SF_11_SK-504	SF_11_SK-501
2.92mm female	40	SF_21_SK-502	SF_21_SK-503	SF_21_SK-504	SF_21_SK-501
2.92mm ruggedised PORT female	40				SF_21_SK-505
2.4mm male	50	SF_11_PC24-502	SF_11_PC24-503	SF_11_PC24-504	SF_11_PC24-501
2.4mm female	50	SF_21_PC24-502	SF_21_PC24-503	SF_21_PC24-504	SF_21_PC24-501
2.4mm ruggedised PORT female	50				SF_21_PC24-505

Available connectors

	Freq. (GHz)	SUCOFLEX 570	SUCOFLEX 570E	SUCOFLEX 570 S
1.85mm male	70	SF_11_PC185-502	SF_11_PC185-503	SF_11_PC185-501
1.85mm female	70	SF_21_PC185-503	SF_21_PC185-504	SF_21_PC185-501
1.85mm ruggedised PORT female	70			SF_21_PC185-502

Order Information

Connector 1
N, SMA, 3.5 mm, 2.92 mm,

Connector 2
2.4 mm, 1.85 mm

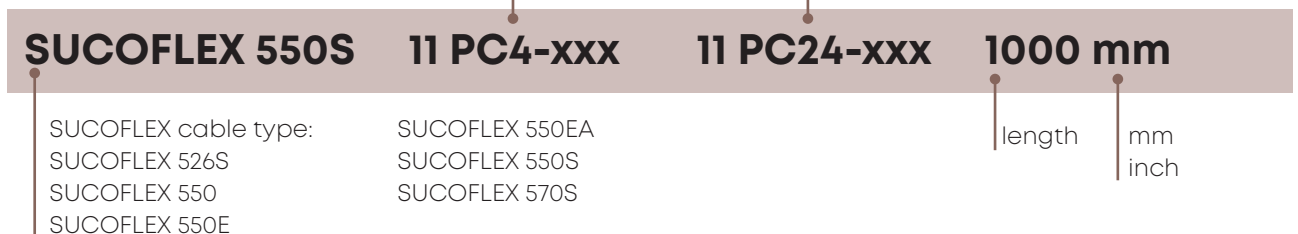

SUCOFLEX 500

Connector configuration

Figure	Marketing name	Cable	B	D	SW / AF.
8	35F	SUCOFLEX_526_V	69.5	19.8	20
5	35VF	SUCOFLEX_526_V	69.5	19.8	20
7	35VM	SUCOFLEX_526_V	69.5	19.8	N/A
9	SF_11_N-501	SUCOFLEX_526_S	75.5	15.6	N/A
9	SF_11_N-503	SUCOFLEX_526	91.5	14.5	N/A
9	SF_11_N-504	SUCOFLEX_526_E	91.5	14.5	N/A
9	SF_11_N-505	SUCOFLEX_526_EA	82	15.6	N/A
2	SF_11_PC185-501	SUCOFLEX_570_S	43	9.2	N/A
2	SF_11_PC185-502	SUCOFLEX_570	64	9.5	N/A
2	SF_11_PC185-503	SUCOFLEX_570_E	64	9.5	N/A
2	SF_11_PC24-501	SUCOFLEX_550_S	43	9.2	N/A
2	SF_11_PC24-502	SUCOFLEX_550	64	9.5	N/A
2	SF_11_PC24-503	SUCOFLEX_550_E	64	9.5	N/A
2	SF_11_PC24-504	SUCOFLEX_550_EA	42	9.2	N/A
2	SF_11_PC24-505	SUCOFLEX_540	64	9.5	N/A
2	SF_11_PC24-506	SUCOFLEX_540_E	64	9.5	N/A
2	SF_11_PC24-507	SUCOFLEX_540_EA	42	11.8	N/A
2	SF_11_PC24-508	SUCOFLEX_540_S	43	9.2	N/A
1	SF_11_PC35-501	SUCOFLEX_526_S	44	11.8	N/A
1	SF_11_PC35-505	SUCOFLEX_550	65.5	9.5	N/A
1	SF_11_PC35-506	SUCOFLEX_550_E	65.5	9.5	N/A
1	SF_11_PC35-507	SUCOFLEX_550_EA	43.5	9.2	N/A
1	SF_11_PC35-508	SUCOFLEX_550_S	44.5	9.2	N/A
1	SF_11_PC35-509	SUCOFLEX_526	65.8	9.5	N/A
1	SF_11_PC35-510	SUCOFLEX_526_E	65.8	9.5	N/A
1	SF_11_PC35-511	SUCOFLEX_526_EA	50.5	15.6	N/A
1	SF_11_SK-501	SUCOFLEX_550_S	44.5	9.2	N/A
1	SF_11_SK-502	SUCOFLEX_550	65.5	9.5	N/A
1	SF_11_SK-503	SUCOFLEX_550_E	65.5	9.5	N/A
1	SF_11_SK-504	SUCOFLEX_550_EA	43.5	9.2	N/A
1	SF_11_SK-505	SUCOFLEX_540	65.5	9.5	N/A
1	SF_11_SK-506	SUCOFLEX_540_E	65.5	9.5	N/A
1	SF_11_SK-507	SUCOFLEX_540_EA	43.5	11.8	N/A
1	SF_11_SK-508	SUCOFLEX_540_S	44.5	9.2	N/A
1	SF_11_SMA-501	SUCOFLEX_526_S	44	11.8	N/A
1	SF_11_SMA-502	SUCOFLEX_526	65.8	9.5	N/A
1	SF_11_SMA-503	SUCOFLEX_526_E	65.8	9.5	N/A
1	SF_11_SMA-504	SUCOFLEX_526_EA	50.5	15.6	N/A
10	SF_21_N-501	SUCOFLEX_526_S	62	15.6	14
10	SF_21_N-502	SUCOFLEX_526	78.5	10	14
10	SF_21_N-503	SUCOFLEX_526_E	78.5	10	14
10	SF_21_N-504	SUCOFLEX_526_EA	68.5	15.6	14

SUCOFLEX 500

Connector configuration

Figure	Marketing name	Cable	B	D	SW / AF.
4	SF_21_PC185-501	SUCOFLEX_570_S	43	9.2	8
4	SF_21_PC185-502	SUCOFLEX_570_S	60	19.8	20
4	SF_21_PC185-503	SUCOFLEX_570	64	9.5	8
4	SF_21_PC185-504	SUCOFLEX_570_E	64	9.5	8
4	SF_21_PC24-501	SUCOFLEX_550_S	43	9.2	8
4	SF_21_PC24-502	SUCOFLEX_550	64	9.5	8
4	SF_21_PC24-503	SUCOFLEX_550_E	64	9.5	8
4	SF_21_PC24-504	SUCOFLEX_550_EA	42	9.2	8
6	SF_21_PC24-505	SUCOFLEX_550_S	60	19.8	20
4	SF_21_PC24-506	SUCOFLEX_540	64	9.5	8
4	SF_21_PC24-507	SUCOFLEX_540_E	64	9.5	8
4	SF_21_PC24-508	SUCOFLEX_540_EA	42	11.8	8
4	SF_21_PC24-509	SUCOFLEX_540_S	43	9.2	8
3	SF_21_PC35-501	SUCOFLEX_526_S	44	11.8	8
5	SF_21_PC35-502	SUCOFLEX_526_S	61	19.8	20
3	SF_21_PC35-506	SUCOFLEX_526	65.8	9.5	8
3	SF_21_PC35-507	SUCOFLEX_526_E	65.8	9.5	8
3	SF_21_PC35-508	SUCOFLEX_526_EA	50.5	15.6	8
3	SF_21_SK-501	SUCOFLEX_550_S	44.5	9.2	8
3	SF_21_SK-502	SUCOFLEX_550	65.5	9.5	8
3	SF_21_SK-503	SUCOFLEX_550_E	65.5	9.5	8
3	SF_21_SK-504	SUCOFLEX_550_EA	43.5	9.2	8
6	SF_21_SK-505	SUCOFLEX_550_S	61	19.8	20
3	SF_21_SK-506	SUCOFLEX_540	65.5	9.5	8
3	SF_21_SK-507	SUCOFLEX_540_E	65.5	9.5	8
3	SF_21_SK-508	SUCOFLEX_540_EA	43.5	11.8	8
3	SF_21_SK-509	SUCOFLEX_540_S	44.5	9.2	8
3	SF_21_SMA-502	SUCOFLEX_526	65.8	9.5	8
3	SF_21_SMA-502	SUCOFLEX_526_E	65.8	9.5	8
3	SF_21_SMA-503	SUCOFLEX_526_EA	50.5	15.6	14

SUCOFLEX 500

Figure 1

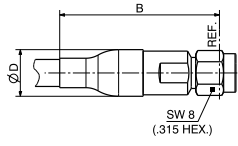

Figure 2

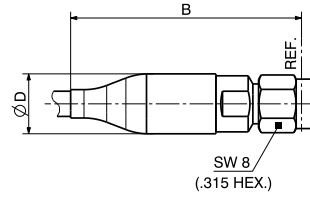

Figure 3

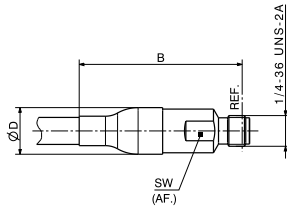

Figure 4

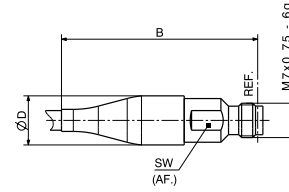

Figure 5

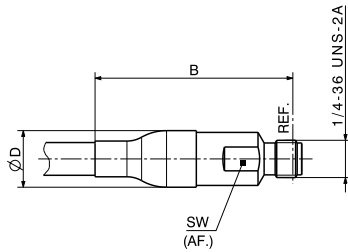

Figure 6

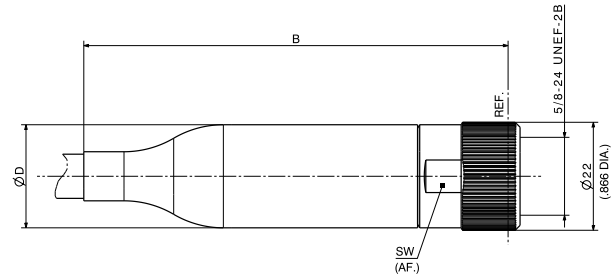

Figure 7

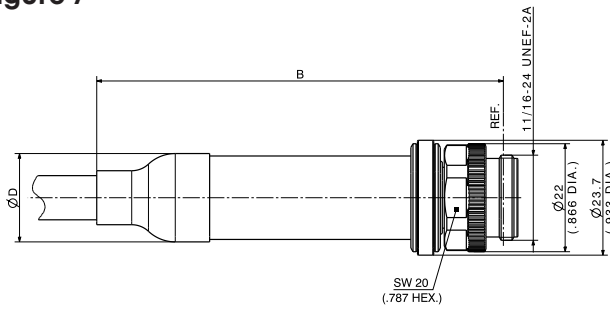

Figure 8

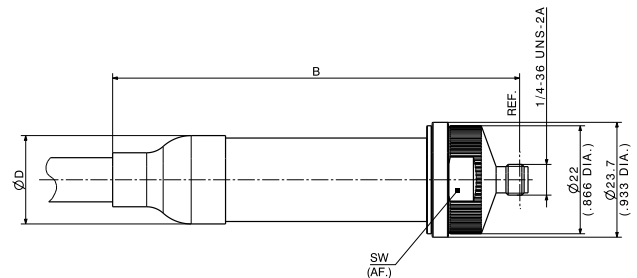

Figure 9

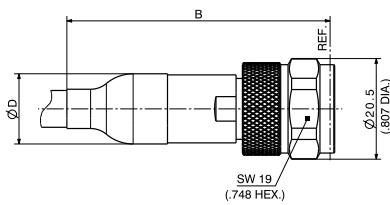
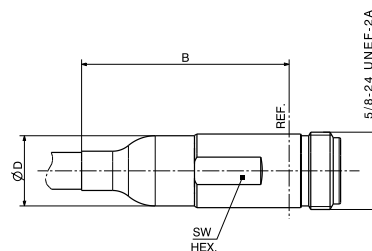

Figure 10



Cable and assembly tools

Use our online tools for fast and efficient calculation and configuration or contact your HUBER+SUHNER partner for specific information.

1. EVALUATE with our eCatalogue

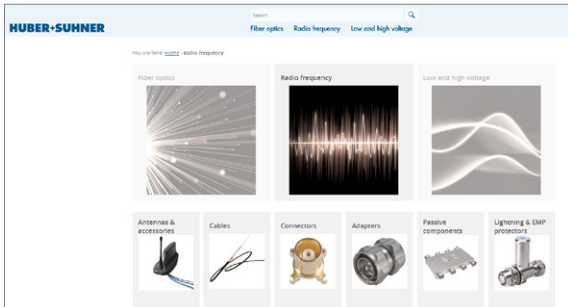

Choose suitable cables by using our "eCatalogue".

<https://ecatalog.hubersuhner.com/>

2. CALCULATE with the assembly calculator

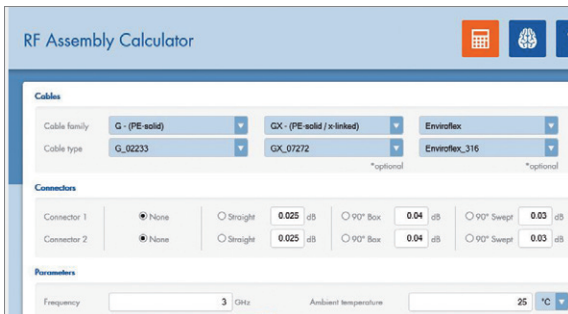

Compare the suitable products and calculate the electrical performance by using the "RF assembly calculator".

<http://rfcablecalc.hubersuhner.com>



More information:
hubersuhner.com

HUBER+SUHNER AG
Degersheimerstrasse 14
9100 Herisau
Switzerland
Phone +41 71 353 41 11
hubersuhner.com

HUBER+SUHNER is certified to ISO 9001, ISO 14001, ISO 45001, EN/AS 9100, IATF 16949 and ISO/TS 22163-IRIS.

Waiver

The facts and figures provided herein are for information only and do not represent any warranty of any kind.