

ALUMINUM ELECTROLYTIC CAPACITOR- TECHNICAL NOTES

Table of Contents

1. General.....	2
1-1 Basic Construction and Structure	2
1-2 Material Composition.....	4
2. Manufacturing Process	6
3. Basic Performance	9
3-1 Capacitance and Energy Storage.....	9
3-2 Tangent of Loss Angle ($\tan \delta$) DF and ESR	9
3-3 Equivalent circuit and ESR of Aluminum Electrolytic Capacitor.....	11
3-4 Leakage Current	12
3-5 Impedance	13
3-6 Temperature Characteristics.....	14
3-7 Frequency Characteristics.....	15
3-8 Load and Storage Characteristic	16
4. Failure Modes.....	19
5. Life.....	20
5-1 Ambient Temperature and Life.....	20
5-2 Ripple Current and Life	21
5-3 Applied Voltage and Life.....	23
5-4 The life calculation formula for each product type.....	24
5-5 The Results of the Lifetime Calculation (Expected Lifetime)	25
6. Caution for Proper Use	26
6-1 General Cautions	26
6-2 Charge and Discharge Application	26
6-3 Inrush Current	28
6-4 Overvoltage Application.....	28
6-5 Reverse Voltage Application	29
6-6 Series / Parallel Connection	30
6-7 Recovery Voltage	31
6-8 Use at High Altitude.....	32
6-9 Use at low temperature	33
7. Product Selection for Application	33

ALUMINUM ELECTROLYTIC CAPACITOR- TECHNICAL NOTES

1. General

1-1 Basic Construction and Structure

Basic construction of aluminum electrolytic capacitor is shown in Fig. 1.

Aluminum electrolytic capacitors consist of anode aluminum foil formed with aluminum oxide film on the surface to function as the dielectric. The cathode aluminum foil functions as a collector, and the liquid electrolyte functions as the real cathode. The electrolyte is impregnated onto a separator (spacer) paper between both foils.

An aluminum oxide film, which is formed through anodization (generally referred to as “forming”) of aluminum foil in an appropriate electrolyte. The oxide film is very thin and its thickness is in proportion to the voltage applied. In this notes, the aluminum oxide film formed by anodization is called an oxide film.

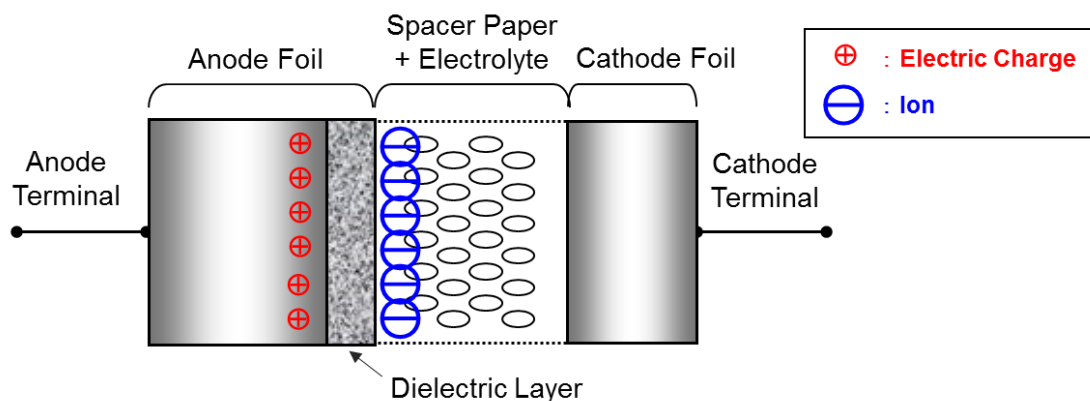

Fig. 1 Basic construction of an aluminum electrolytic capacitor

- Anode: Substrate of anode aluminum foil
- Cathode: The true cathode is electrolyte
- Dielectric: Aluminum oxide film formed on the surface of anode foil
- Cathode Foil: Electrically connects electrolyte to external terminal. The cathode foil does not require a forming process to form oxide film. Rather, it is covered with a natural oxide film on the surface due to the reaction of aluminum with oxygen in the air after etching. It is said that this natural oxide film has the withstanding voltage of approximately 1 to 2 volts.
- Spacer Paper: Preventing physical contact between anode and cathode foil is essential for electrical isolation and is necessary to store electrolyte.

The oxide film on the anode foil withstands a DC voltage only when the capacitor is charged as positive polarity to the aluminum substrate and negative to the electrolyte. If the capacitor is charged with reversed polarity, it will lose withstanding voltage property in a few seconds. This phenomenon is called “The Valve Effect”, which is the reason why aluminum electrolytic capacitors have a polarity. If both electrode aluminum foils have a formed oxide film, then the capacitor will be a non-polarized.

ALUMINUM ELECTROLYTIC CAPACITOR- TECHNICAL NOTES

Various papers report the mechanism for “Valve Effect” of aluminum in which the predominant “Hydrogen Ion Theory” is explained hereunder. When the system, including aluminum foil with anodic oxide film and electrolyte are charged so that the electrolyte is at the positive side and the metal at the negative side, the hydrogen ions gathered on the surface of the oxide film pass through the film to reach the boundary between the metal and the film and convert into hydrogen gas through discharge. Bubbles of hydrogen gas peel the oxide film off the aluminum substrate with expanding force so that electric current flows after penetration of electrolyte. On the contrary, when the system is charged with reversed polarity, negative ions with much larger diameter gather on the surface of the film. However, the film maintains voltage because such negative ions are unable to pass through the film due to their larger diameter.

As shown in Fig. 2, an aluminum electrolytic capacitor element has a cylindrical structure in which anode foil, cathode foil and separator paper are wound with electrode terminals.

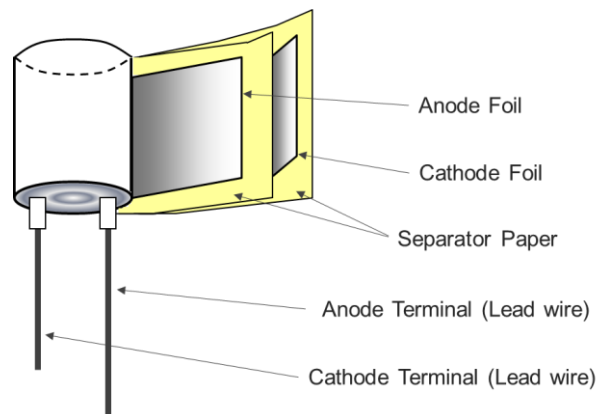

Fig. 2 Structure of aluminum electrolytic capacitor element

An aluminum electrolytic capacitor is manufactured by impregnating the capacitor element with an electrolyte and enclosing it with an aluminum case and sealing materials. The type of terminal and sealant structure are different for each product type. Basic structures are shown in Fig. 3. SMD (Surface Mount) types have a shape in which the lead wires are processed and a seat plate is attached so as to accommodate surface mounting. Snap-in type have a tab connected to the sealing plate with snap-in terminal instead of lead wire, and then sealed by the sealing plate.

ALUMINUM ELECTROLYTIC CAPACITOR- TECHNICAL NOTES

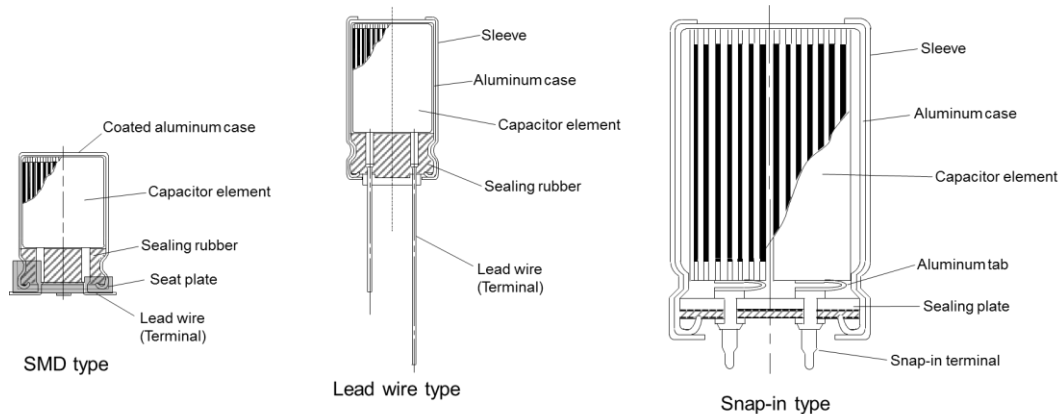

Fig. 3 Basic structure of aluminum electrolytic capacitor

1-2 Material Composition

《Electrode foil》

For electrode foil, high purity foil (generally 99% or more) with a thickness of 20 μ m to 120 μ m.

In order to obtain a large electrostatic capacitance, an electrochemical roughening treatment is applied. This process is called etching which increases the electrode foil surface area. The shape of the pits formed by this etching process is selected by considering area efficiency. Porous pit shape by AC etching method for low voltage capacitors and straight pit shape by DC etching method for high voltage capacitor is selected, respectively (Photo 1).

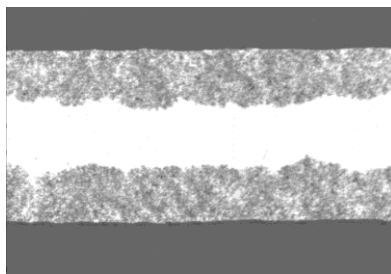

Low voltage foil

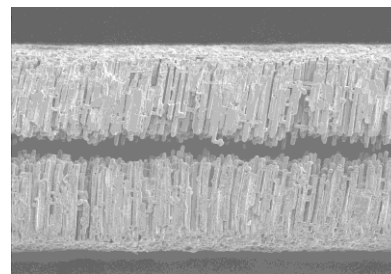

High voltage foil (Replica)

Photo 1 Cross section of aluminum etched foil

Anodic oxidation treatment is applied for etched foil to form aluminum oxide dielectric layer on the foil surface to obtain target withstand voltage (Photo 2).

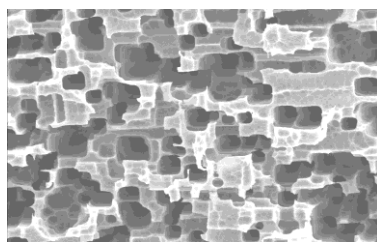

Etched foil

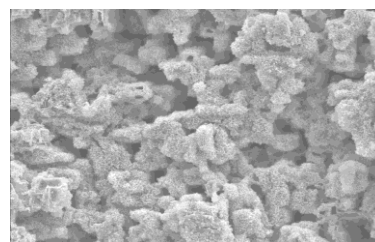

Formed foil

Photo 2 Surface of high voltage foil

ALUMINUM ELECTROLYTIC CAPACITOR- TECHNICAL NOTES

《Separator paper》

Separator paper is mainly composed of natural cellulose fibers and its thickness is generally from 20 μ m to 90 μ m. Paper thickness and type are selected according to product impedance and rated voltage. High density and thick paper tends to be used for products with a high rated voltage, low density paper is selected for low impedance products. Photo 3 shows enlarged photograph of separator paper for low and high voltage. Low voltage separator is made of relatively thin and round shaped fibers for the purpose of low impedance (low ESR). In contrast, High voltage separator is made of flattened fibers to maintain high withstand voltage.

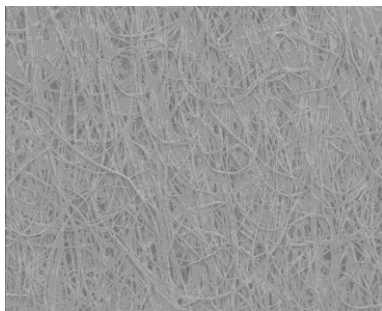

Low voltage separator



High voltage separator

Photo 3 Surface of separator paper

《Electrolyte》

Electrolyte is a solution with ionic substance dissolved in solvent. It is an important material composition because its characteristics greatly affect withstand voltage, temperature and frequency characteristics, along with the life of the product. We select the optimum electrolyte according to the rated voltage, operating temperature range, and other required characteristics.

Electrolyte is also responsible for repairing defective areas of the anode dielectric layer. This repair performance is a unique feature of electrolytic capacitors not found in other capacitors such as ceramic and film.

《Case and Sealing Material》

In order to prevent the dry out and leakage of electrolyte, an airtight seal is necessary. This is accomplished by the aluminum case and sealing material. In addition, a safety vent (explosion-proof valve) is placed in the case or sealing material in order to cope with internal pressure rise due to substantial gas generation under abnormal conditions.

Insulative rubber or resin is used for sealing material as it also serves to prevent short circuit between external electrode terminals or case / external electrode terminals.

ALUMINUM ELECTROLYTIC CAPACITOR- TECHNICAL NOTES

2. Manufacturing Process

Etching

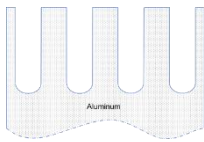

Fig. 4

To obtain higher capacitance, surface area of aluminum foil for electrolytic capacitor increases through the etching process.

During the etching process, a DC or AC current is applied to the aluminum foil. This is done in a chloride solution to assist to dissolve the surface. Surface area is increased by 60-150 times for low voltage foils and 10-30 times for high voltage foils.

Anodization
(Formation of Dielectric Layer)

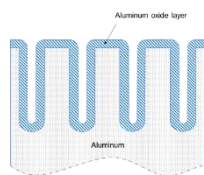

Fig. 5

Aluminum foil for electrolytic capacitor are further formed with anodic oxide film (Al_2O_3) on the surface as dielectric layer.

Etched aluminum foil is immersed into a solution including ammonium salt of boric or phosphoric acid and applied with DC voltage so that the foil becomes positive and the solution becomes negative. Then the aluminum oxide film is formed on the surface in proportion to the applied voltage. The anodic oxide film, having the thickness of 13-15 angstrom/V (1.3-1.5 nm/V), is extremely thin, compact and highly insulating.

Slitting

The master formed roll is then slit into individual rolls with specified width as per the specification.

Stitching
Winding

Slit anode and cathode foils are then stitched with aluminum tabs and wound into cylindrical element together with separator paper. The Separator paper has the function of containing the liquid electrolyte that functions as the real cathode and restores the damaged dielectric layer. It also maintains a safe distance between anode and cathode foils to prevent a short circuit.

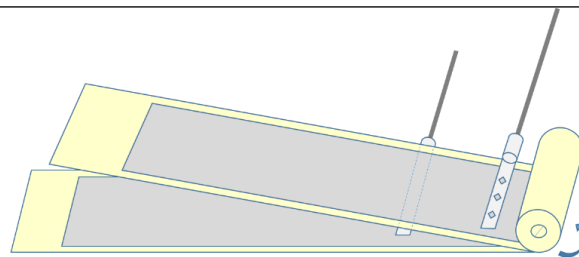

Fig. 6

ALUMINUM ELECTROLYTIC CAPACITOR- TECHNICAL NOTES

Impregnation

The wound element is immersed into an electrolyte bath under either a low or normal air pressure condition to impregnate the paper. Electrolyte contains one or more polyhydric alcohols such as ethylene glycol as the major solvent and one or more ammonium salts as solutes to restore the damaged dielectric layer and significantly improve the performance and life of the capacitor.

Assembling

Attach rubber bung / rubber-lined terminal plate / molded terminal plate to impregnated element and seal it with the aluminum case.

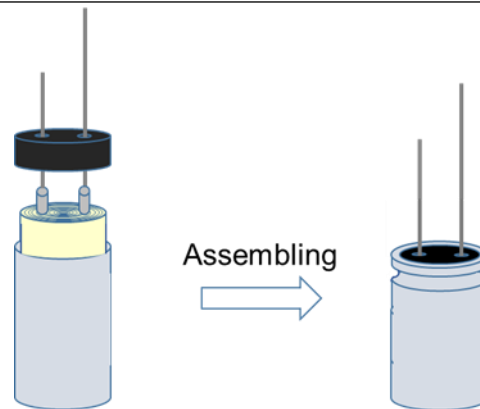

Fig. 7

Attaching Sleeve

The sealed capacitor is then covered with sleeve made of a heat shrinkable resin. The purpose of sleeve is to indicate key information of the capacitor. When electric insulation of the inner element or aluminum case are required, consult our team for proper materials selection vs standard sleeving. Not all of our products employ a sleeving procedure. Our surface mount is an example. We employ a laminated can with printing on the case.



Photo 4

Aging

A dielectric layer is formed during the anodization (forming) process, but aluminum substrate is exposed during the slit and stitching process. The dielectric layer can also expose imperfection areas during the winding procedure. Restoring the dielectric layer is necessary for the capacitor to function properly per our specification. During the aging process, the capacitors are applied with a high DC voltage and temperature. This repairs the damaged dielectric layer. The aging process also assists to stabilize the leakage current of capacitor and helps to debug initial failures.

(Reforming)

ALUMINUM ELECTROLYTIC CAPACITOR- TECHNICAL NOTES

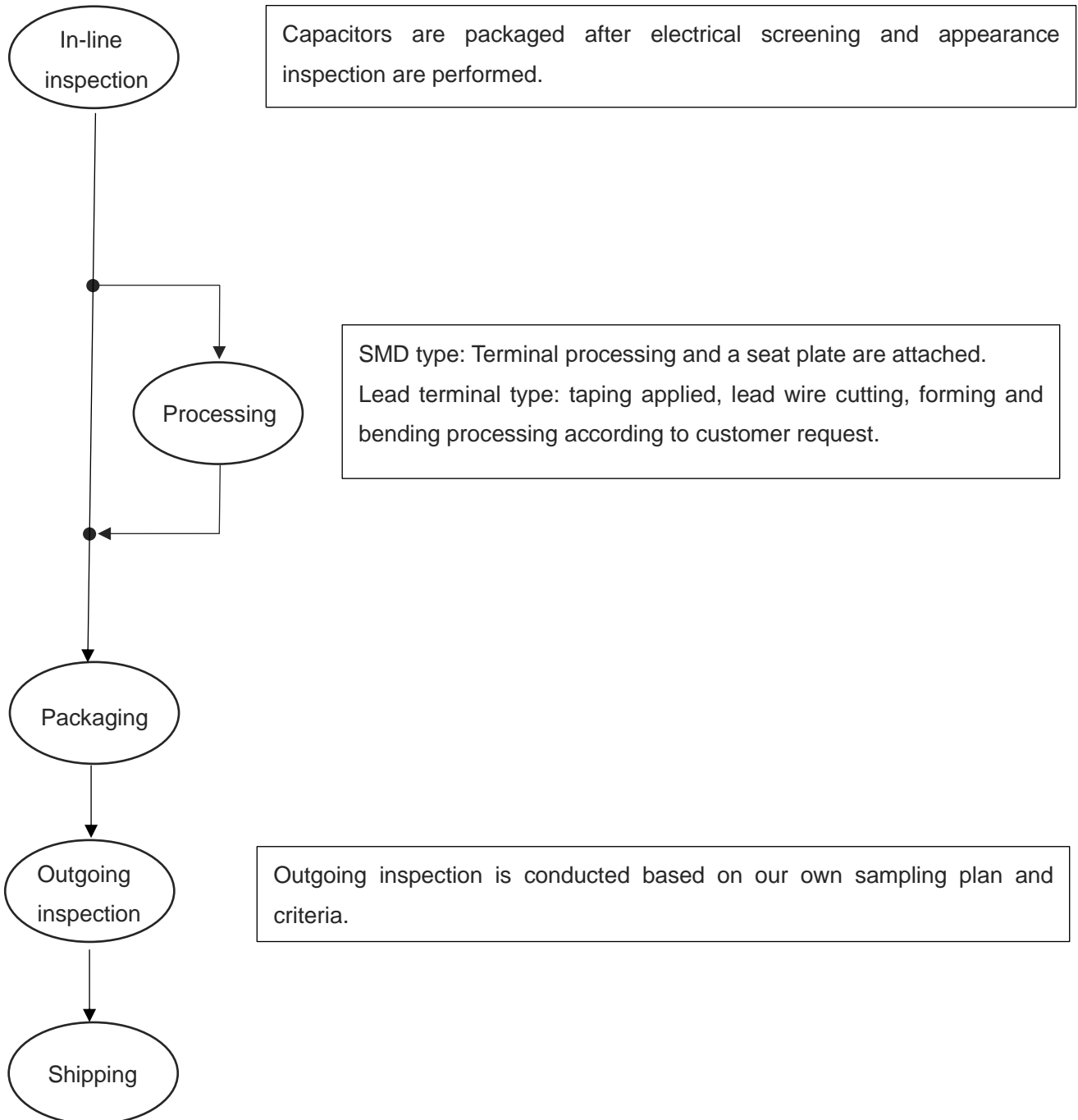

ALUMINUM ELECTROLYTIC CAPACITOR- TECHNICAL NOTES

3. Basic Performance

3-1 Capacitance and Energy Storage

Capacitance of a capacitor is generally expressed with the following formula (Equation 1).

$$C = \varepsilon_0 \varepsilon_r \frac{S}{d} \quad \text{Eq.1}$$

{	C :	Capacitance (F)
	ε_0 :	Permittivity of vacuum (8.854×10^{-12} F/m)
	ε_r :	Relative permittivity
	S :	Area of facing electrodes (m^2)
	d :	Distance between electrodes (m)

On aluminum electrolytic capacitor, “ S ” is effective surface area of anode foil enlarged to 60 to 150 times of the projected area through etching process. “ d ” corresponds to the thickness of dielectric (13 to 15 angstroms per volt). Relative permittivity “ ε_r ” of aluminum oxide film is about 8.5.

Actual aluminum electrolytic capacitor are composed of anode foil and cathode foil as shown in Fig. 1, and cathode foil also has natural oxide film or oxide film formed with a low forming voltage and has capacitance. Therefore, product capacity C of the aluminum electrolytic capacitor is calculated as shown in Equation 2, considering that capacitance of anode foil C_a and capacitance of cathode foil C_c are connected in series.

$$C = \frac{C_a C_c}{C_a + C_c} \quad \text{Eq.2}$$

Electric charges Q (Coulomb) stored in capacitor when the voltage V (volts) is applied between the terminals are expressed as follows (Equation 3).

$$Q = CV \quad \text{Eq.3}$$

The work W (Joule) made by the charge Q is expressed as shown in Equation 4.

$$W = \frac{1}{2} QV = \frac{1}{2} CV^2 \quad \text{Eq.4}$$

3-2 Tangent of Loss Angle ($\tan \delta$) DF and ESR

When a sinusoidal alternating voltage is applied to an ideal capacitor, the current advances by $\pi/2$ in phase. In the case of a practical capacitor, however, advance in phase is $(\pi/2 - \delta)$, which is smaller than $\pi/2$. “ δ ” is referred to as Loss Angle (Fig. 8).

Tangent of this loss angle ($\tan \delta$) is used to show magnitude of the loss, the smaller this value, the higher the performance and the closer to and ideal capacitor. The inverse value of $\tan \delta$ corresponds to “Q – Factor”.

ALUMINUM ELECTROLYTIC CAPACITOR- TECHNICAL NOTES

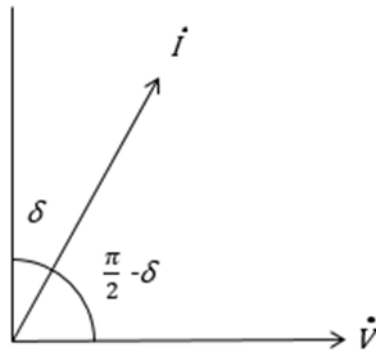

Fig. 8 Loss Angle

Fig. 8 is the explanation of Loss-angle in phasor. Alternative voltage and current are represented as vectors whose length corresponds to the effective value (r.m.s). To distinguish the real voltage $V(t)$ and $I(t)$, the dot is added as \dot{V} and \dot{I} respectively.

AC Impedance Z is defined as the complex ratio of \dot{V} to \dot{I} which represents the relation of alternative voltage and current.

$$\dot{V} = Z\dot{I} \quad \text{Eq.5}$$

The impedance Z of the serial connection of capacitance C and R is given as below.

$$Z = -j\frac{1}{\omega C} + R \quad \text{Eq.6}$$

Where, ω is the angular frequency, and has the below relation with frequency f [Hz].

$$\omega = 2\pi f \quad \text{Eq.7}$$

Fig. 9 represents Eq.6 in the complex plane. X_c is the imaginary part of the impedance which is called "Capacitive Reactance", R is the resistance that corresponds to the real part of the impedance and δ is Loss angle.

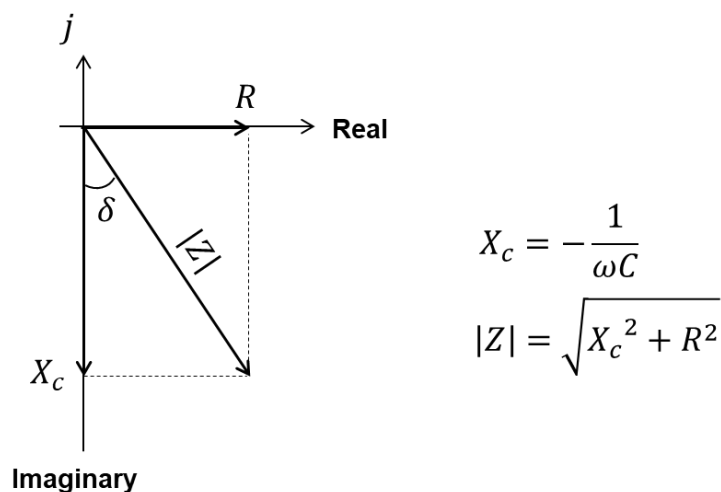

Fig. 9 Impedance and Loss angle of Capacitor

Referring to Fig. 9, the relation of Loss tangent $\tan\delta$, R and X_c is as below.

ALUMINUM ELECTROLYTIC CAPACITOR- TECHNICAL NOTES

$$\tan\delta = \frac{R}{X_c} = \omega CR = 2\pi fCR \quad \text{Eq.8}$$

3-3 Equivalent circuit and ESR of Aluminum Electrolytic Capacitor

As explained in 3-2, the real part of the capacitor (impedance) represents the resistance component. Capacitor impedance can be expressed approximately by the serial connection circuit of capacitance C , resistance R and inductance (Three-Element Model), which is referred to in section 3-5.

One of the reasons why loss angle arises is electric resistance of materials used in electrolytic capacitor, including the intrinsic resistance of foil, resistance of electrolyte and resistance of terminals. Another reason is due to the dielectric relaxation phenomenon. When voltage applied to the capacitor changes, polarization of dielectric does not immediately reach equilibrium state, so current response is delayed and a loss (dielectric loss) occurs. Dielectric loss ($\tan \delta$) has a specific value for each dielectric material. Resistance component due to dielectric loss becomes $\tan \delta / 2\pi fC$ from Equation 5 and it will be inversely proportional to frequency. Therefore, resistance component of the capacitor has a frequency dependence, and resistance increases as frequency decreases. Figure 10 shows the equivalent circuit of aluminum electrolytic capacitor. R is called the equivalent series resistance (ESR), which corresponds to resistance when the resistance described above is represented as series equivalent circuit of Fig. 10.

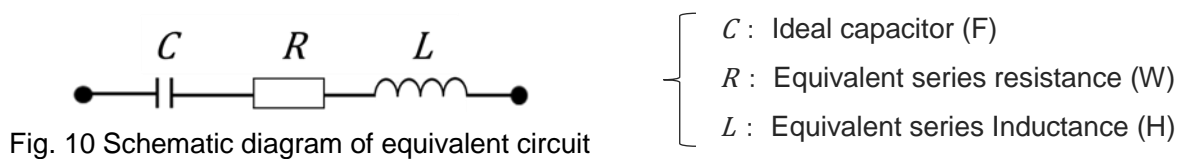

The components of resistance and inductance of this Three-Element Model is called the equivalent series resistance (ESR) and the equivalent series inductance (ESL) respectively. The capacitance and ESR of the real capacitors have characteristics depending on frequency, temperature, and bias voltage. See Sections 3-6 for the temperature characteristics of the impedance of aluminum electrolytic capacitors. ESL value is determined by the terminal configuration (current path configurations between anode and cathode terminals), it can be considered as a constant value in the operational range of frequency and temperature. Hence, we explain the detail of the ESR of aluminum electrolytic capacitors as follows.

The ESR of aluminum electrolytic capacitors is composed of three parts, (i) the dielectric loss of aluminum oxide film, (ii) the resistance of the electrolyte impregnated spacer paper, (iii) the ohmic resistance of the electrode foil metal parts, the leading tabs, etc. As to (i) the dielectric loss, it is caused by the delay in the polarization response of the oxide film. Since the resistance component due to the dielectric loss is proportional to the reactance X_c (the proportional coefficient corresponds to the Loss-tangent of the oxide film), this resistance is proportional to the reciprocal frequency. Therefore, as the dielectric loss component becomes dominant in ESR values in the lower frequency range, it is significant for the rated ripple current (specified in 100Hz/120Hz) and the dissipation calculation for the commercial power supply

ALUMINUM ELECTROLYTIC CAPACITOR- TECHNICAL NOTES

frequency. Concerning (ii) the resistance by paper and electrolyte, the resistivity of electrolytes is quite large to the metal and has a huge temperature dependency. Therefore, the impedance change for temperatures of aluminum electrolytic capacitors is remarkable comparing other types of capacitors. This resistance component determines the ESR value in the frequency range, e.g. 10kHz, where (i) the dielectric loss becomes too small to neglect. Since the carrier frequency of general power-converters is set into this frequency range, it can be said that the performance of the secondary smoothing capacitor relies on the electrolyte. (iii) the ohmic resistance of metal parts is considered as a constant value in the range of operating frequency and temperature. Thus, this resistance dominates in ESR when the frequency is above 10kHz and the temperature is relatively high. (see Fig. 11)

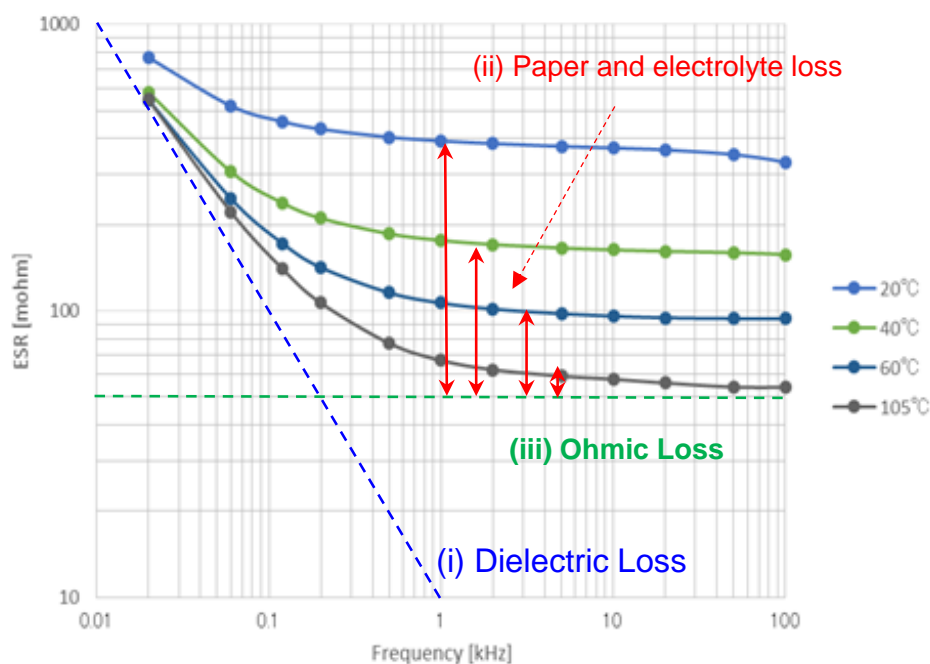

Fig. 11 ESR Characteristics of Aluminum Electrolytic Capacitor

3-4 Leakage Current

When a voltage is applied to the aluminum electrolytic capacitor, a large current (charge current) determined by the capacitance and series resistance of the capacitor flows first, but the current gradually decreases. It eventually converges to a constant current (leakage current) due to disappearing the influence of absorption current. (Fig. 12)

ALUMINUM ELECTROLYTIC CAPACITOR- TECHNICAL NOTES

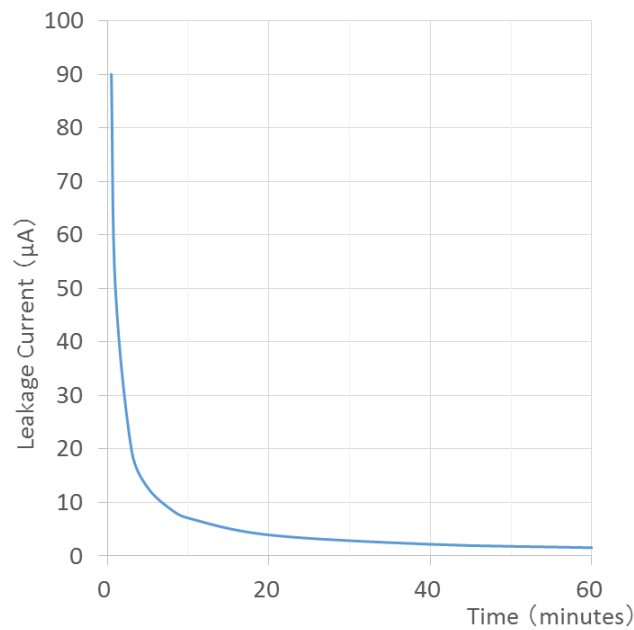

Fig. 12 Leakage current change after voltage application

Factors of this slight leakage current include the presence of defects in the dielectric layer (aluminum oxide), destruction of the dielectric layer due to impurities and the like, and reparation by electrolyte components. Intrinsically, leakage current means this convergent current, but since it takes a long time to converge, for convenience, the current after 1 to 5 minutes (specify the time for each product) from applying the rated voltage in the 20 ° C environment is specified as leakage current in the product catalog.

3-5 Impedance

Impedance (Z) is the factor that impedes the flow of current when an alternating voltage is applied to the capacitor, which is expressed as $Z=1/j\omega C+j\omega L+R$ and its magnitude is shown in Eq.9.

$$|Z| = \sqrt{R^2 + (X_L + X_C)^2} = \sqrt{R^2 + \left(2\pi f \cdot L - \frac{1}{2\pi f \cdot C}\right)^2} \quad \text{Eq.9}$$

Where, R : ESR, X_L : Inductive reactance, and X_C : Capacitive reactance.

Fig. 13 is the schematic illustration of impedance and ESR, where X_C is predominant in a low-frequency range, ESR around the resonance point, and X_L in a high-frequency range.

ALUMINUM ELECTROLYTIC CAPACITOR- TECHNICAL NOTES

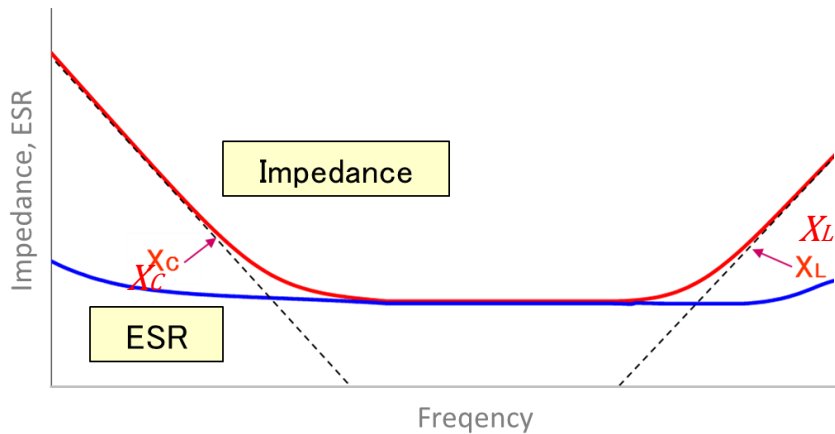

Fig. 13 Schematic illustration of impedance and ESR Frequency Characteristics

3-6 Temperature Characteristics

Each characteristic of aluminum electrolytic capacitor has temperature dependence, and especially in low-temperature range, a large decrease in capacitance and increase in impedance and tangent of loss angle ($\tan \delta$) may be seen due to increase in resistance of electrolyte. Leakage current increases as temperature increases. Fig. 14 to Fig. 16 show capacitance and impedance, the tangent of loss angle ($\tan \delta$), and leakage current change with temperature.

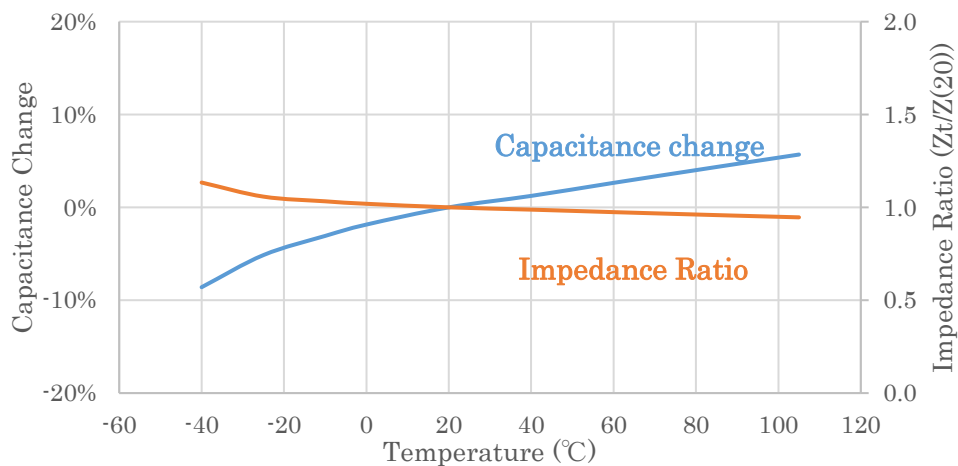

Fig. 14 Temperature Characteristics of capacitance change and impedance ratio (based on 20 °C)

ALUMINUM ELECTROLYTIC CAPACITOR- TECHNICAL NOTES

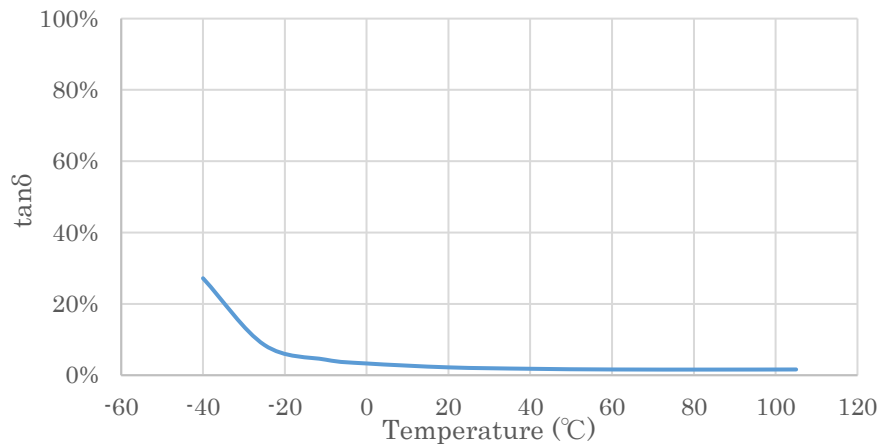

Fig. 15 Temperature Characteristics of the tangent of loss angle (tan δ)

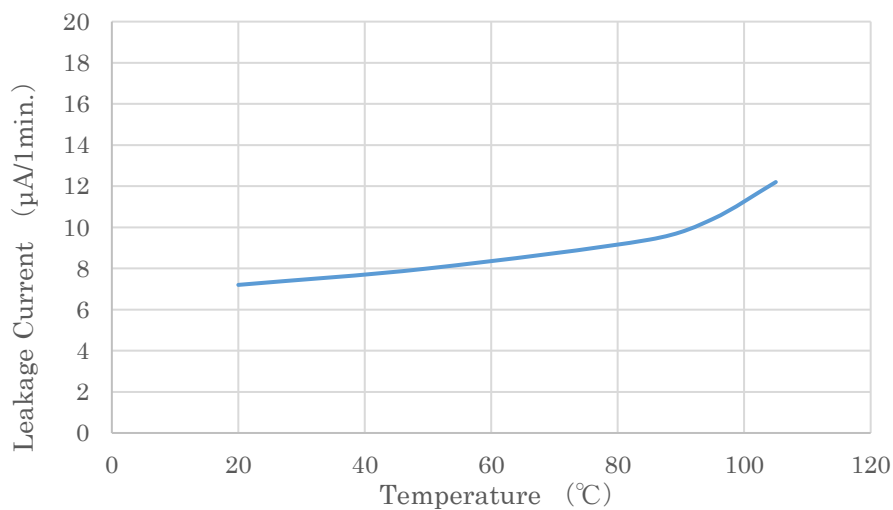

Fig. 16 Temperature Characteristics of leakage current

3-7 Frequency Characteristics

Characteristics of aluminum electrolytic capacitors are also frequency-dependent. Capacitance reduces as measuring frequency increases. The change of impedance and ESR is described in 3-5 (Fig. 13). However the rate of the change is not constant, the presumed reasons are as follows:

- 1) Condition of the etched surface of aluminum foil
- 2) Property of aluminum oxide layer as dielectric
- 3) Property of electrolyte
- 4) Construction of capacitor

The Frequency-response curve of capacitance is shown in Fig. 17.

ALUMINUM ELECTROLYTIC CAPACITOR- TECHNICAL NOTES

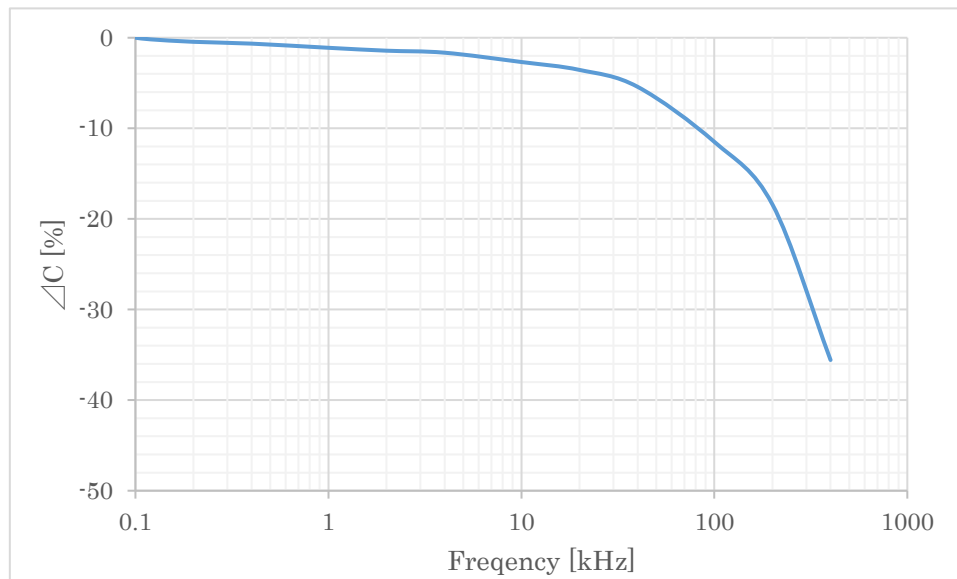

Fig. 17 The Frequency-response curve of capacitance

3-8 Load and Storage Characteristic

When an aluminum electrolytic capacitor is applied with a DC voltage or a DC voltage with superimposed ripple current for a long time, the capacitance will reduce and the tangent of loss angle will increase. Specifications are provided for these changes in the individual characteristics to judge the practical life of the capacitor. When aluminum electrolytic capacitors are stored for a long time without electric charge, the capacitance will also reduce and the tangent of loss angle will also increase. Changes in capacitance and the tangent of loss angle are primarily caused due to loss of electrolytes through dissipation and decomposition, which are accelerated in a high-temperature atmosphere.

In load life testing, leakage current generally stays low because the aluminum oxide layer used as the dielectric is always repaired by the applied DC voltage with consuming electrolyte. On the contrary, in the shelf life test, leakage current may increase because the repairing process of the aluminum oxide layer does not operate unless DC voltages are applied.

Changes in characteristics in the rated voltage load test (Life test) and the no-load storage test (Shelf test) at 105 ° C are shown in Fig. 18 to Fig. 20.

ALUMINUM ELECTROLYTIC CAPACITOR- TECHNICAL NOTES

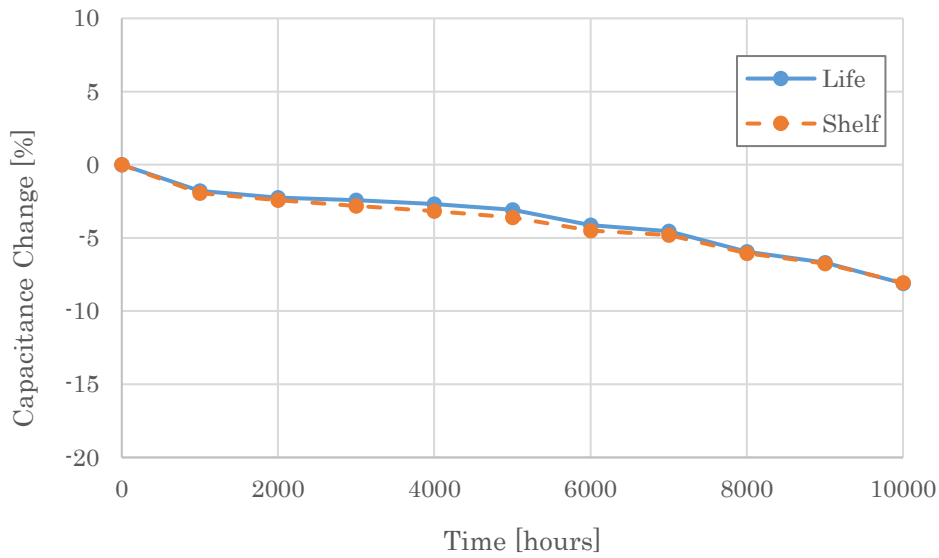

Fig. 18 Changes in capacitance with time at 105 °C

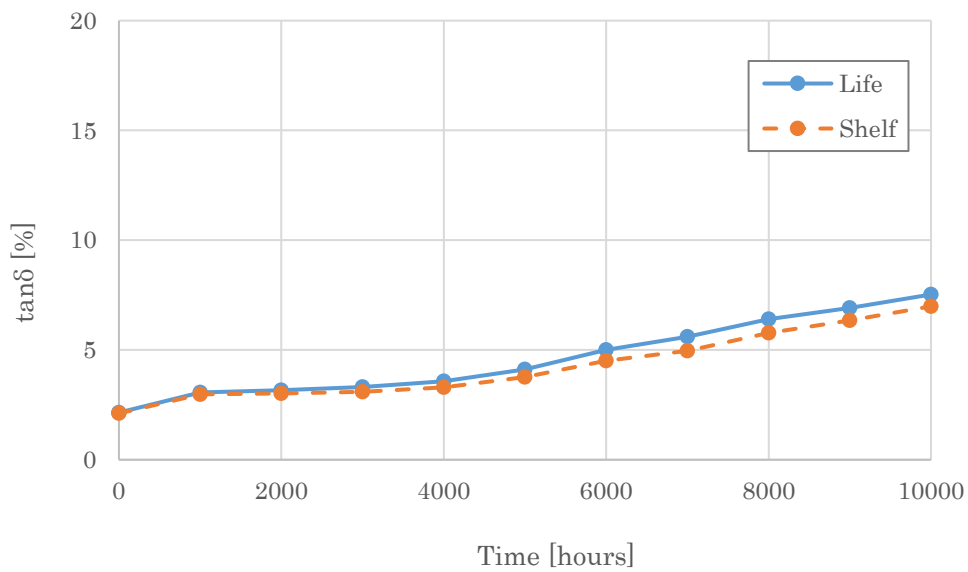

Fig. 19 Changes in tangent of loss angle ($\tan \delta$) with time at 105 °C

ALUMINUM ELECTROLYTIC CAPACITOR- TECHNICAL NOTES

Fig. 20 Changes in leakage current with time at 105 °C (only life)

ALUMINUM ELECTROLYTIC CAPACITOR- TECHNICAL NOTES

4. Failure Modes

Please refer to the following diagram of the representative failure mode and its factors.

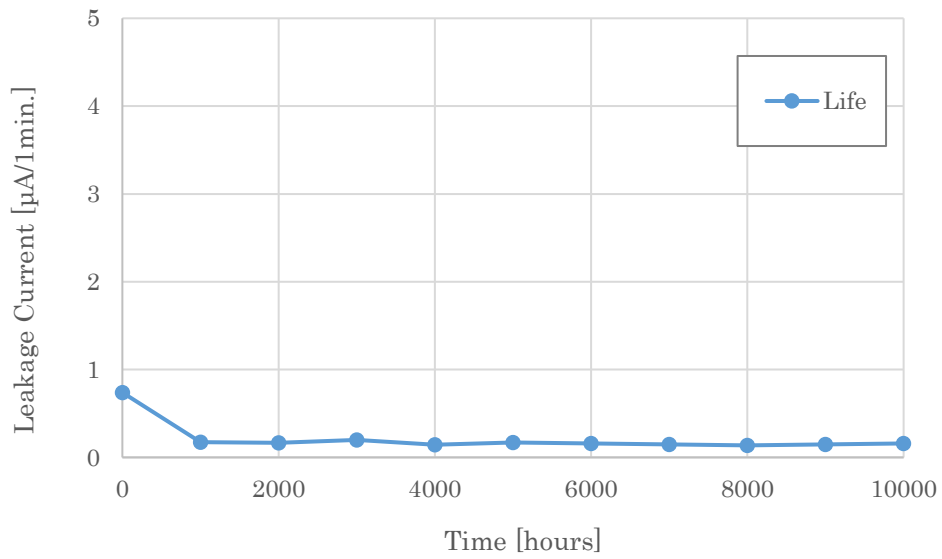
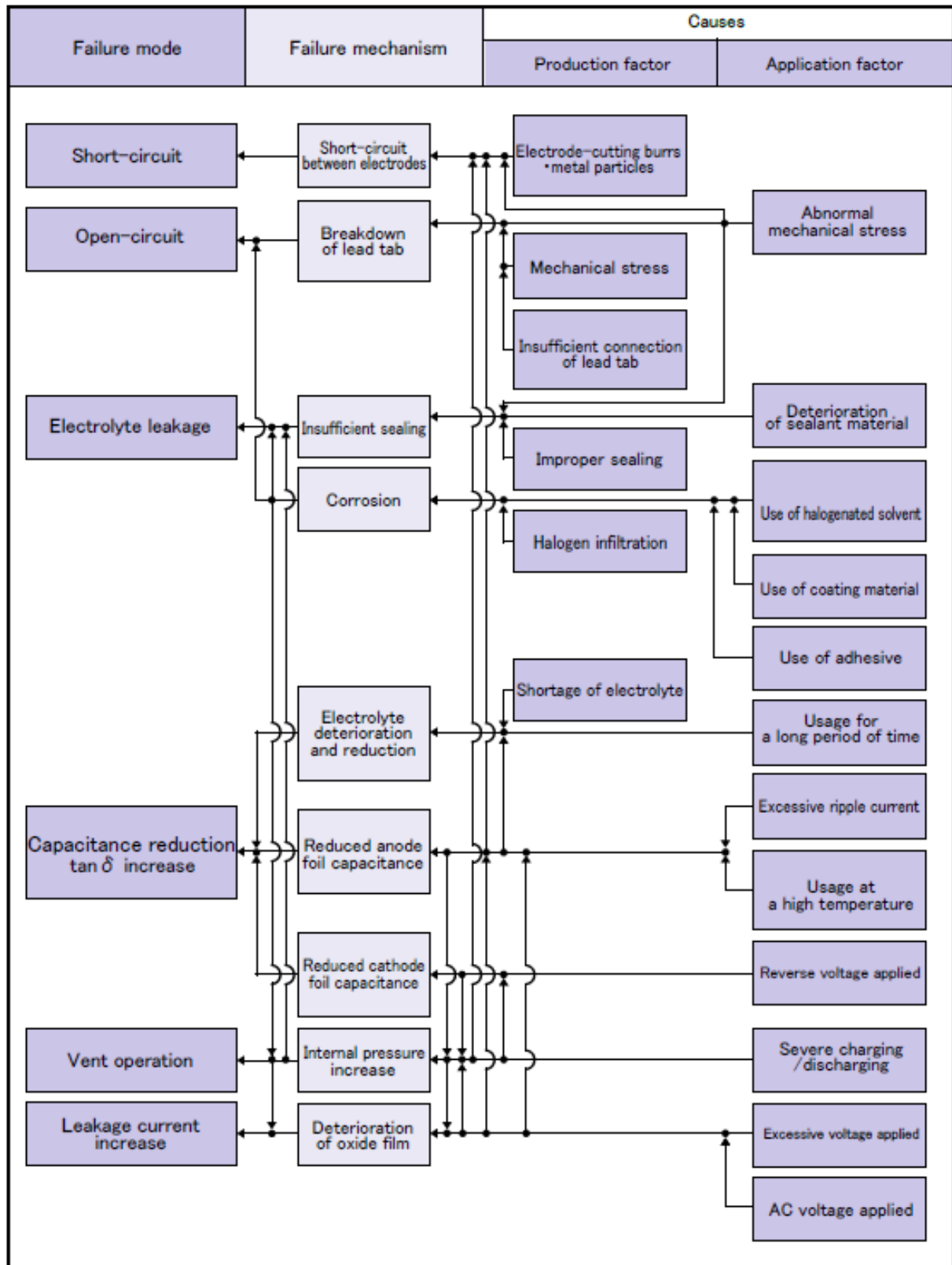

ALUMINUM ELECTROLYTIC CAPACITOR- TECHNICAL NOTES

5. Life

Aluminum electrolytic capacitors are greatly affected by the use conditions (environmental conditions, electrical loads, etc.), and come to the end of their usefulness due to a decrease in the capacitance and increase in the tangent of the loss angle ($\tan \delta$). Degradation of this characteristic is caused by the reduction of the electrolyte in the capacitor element and is generally explained as a diffusion phenomenon, which dissolves electrolyte into sealing rubber material and evaporates to outside.

5-1 Ambient Temperature and Life

The life of aluminum electrolytic capacitors is highly dependent on temperature, and the relation between the ambient temperature and the lifetime is expressed by Equation 7 based on the theory (10°C 2 times law) that the lifetime doubles as the temperature decreases by 10 °C.

$$L = L_0 2^{\frac{T_{max} - T_a}{10}} \quad \text{Eq.10}$$

{	L	: Estimated lifetime (hours)
	L_0	: Estimated lifetime (hours)
	T_{max}	: Maximum category temperature (°C)
	T_a	: Ambient temperature (°C)

Diffusion of the electrolyte from the sealing rubber material is generally the dominant factor in the life of an aluminum electrolytic capacitor, and its speed (diffusion coefficient) is consistent with the Arrhenius law. Figure 20 shows the comparison of the Arrhenius law and the "10°C 2 times law" commonly used for life calculation of electrolytic capacitors. The Arrhenius law and the "10°C 2 times law" show good consistency in the range of 70°C to 90°C, but there is some deviation of "10°C 2 times law" in the temperature range less than 60°C or more than 105°C.

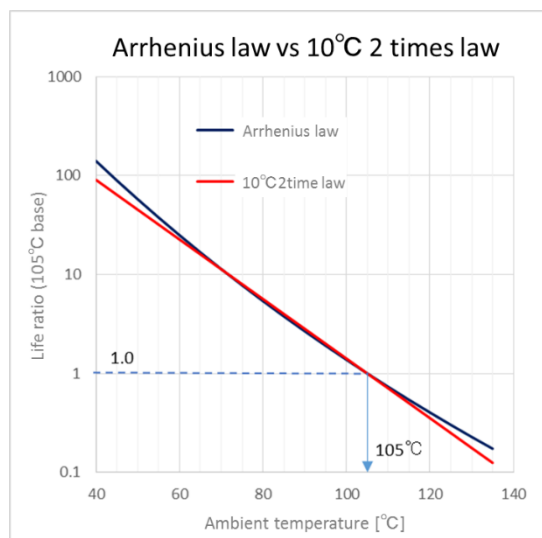

Fig. 21 Arrhenius law vs 10°C 2 times law (105°C base)

ALUMINUM ELECTROLYTIC CAPACITOR- TECHNICAL NOTES

Therefore, the life calculation formula described in the following section is mainly applied to products with an upper category temperature limit of 105°C or less. For estimating the life expectancy of products with a category temperature upper limit of 125°C or higher, please contact us

5-2 Ripple Current and Life

An aluminum electrolytic capacitor generates Joule's heat (self-heating) when ripple current is applied due to higher loss in comparison with other types of capacitors. Due to this self-heating, the internal core temperature of the capacitor (at the element) is higher than the ambient or surface temperature of the capacitor. Since the ESR of the capacitor increases due to electrolyte dry-up, heat generation by ripple current continues to rise. Therefore, it is necessary to consider acceleration which is larger than equation 10 for estimating expected life when ripple current is applied.

(1) Temperature At Surface Of Case And At Core Of Capacitor When Ripple Current Is Applied

The temperature rise of the capacitor when ripple current is applied is expressed by Equation 11.

$$\Delta T_c = \frac{I^2 R}{\beta S} \quad \text{Eq. 11}$$

$$\left\{ \begin{array}{l} \Delta T_c : \text{Surface heat rise by ripple current (}^\circ\text{C)} \\ I : \text{Ripple current (Arms)} \\ R : \text{ESR of the capacitor (}\Omega\text{)} \\ S : \text{Surface area of the capacitor (cm}^2\text{)} \\ \beta : \text{Heat radiation factor (W/}^\circ\text{C}\cdot\text{cm}^2\text{)} \end{array} \right.$$

The value of β generally becomes smaller as the surface area becomes larger. β is approximately estimated by equation 12.

$$\beta = 2.3 \times 10^{-3} \cdot S^{-0.2} \quad \text{Eq. 12}$$

Where β is the factor when heat rise is measured on the surface of the capacitor.

ALUMINUM ELECTROLYTIC CAPACITOR- TECHNICAL NOTES

(2) Temperature difference between Core and Case Surface of Capacitor

The temperature difference between the core and the case surface of the capacitor can be expressed by equation 13.

$$\Delta T_e = \alpha \Delta T_c = \Delta T_0 \left(\frac{I}{I_0} \right)^2 \quad \text{Eq. 13}$$

{	ΔT_e	: Heat rise at the core (°C)
	α	: Factor of the temperature difference between core and surface (Table 1 and 2)
	ΔT_c	: Heat rise at the surface (°C)
	ΔT_0	: Heat rise at the core when rated ripple current is applied (°C) (see Note 1 in below)
	I	: Actual ripple current converted to specified frequency (Arms) (see Note 2 in below)
	I_0	: Rated ripple current (Arms)

Table 1 Temperature Difference Factor (SMD / Radial Lead Capacitors)

Case Dia (mm)	$\phi 4 \sim \phi 8$	$\phi 10$ $\phi 12.5$	$\phi 14.5, \phi 16$ $\phi 18$
α	1.0	1.1	1.2

Table2 Temperature Difference Factor (Snap-in type)

Case Dia (mm)	$\phi 20$	$\phi 22$	$\phi 25$	$\phi 30$	$\phi 35$
α	1.3	1.3	1.4	1.5	1.64

Note 1 ΔT_0 is specified for each series. Please inquire about details.

Note 2 Frequency coefficient is specified for each series. By measuring the effective value of ripple current for each frequency of actual use condition and dividing by frequency coefficient described in the product catalog, rated ripple current can be converted to effective value at a defined frequency. (Equation 14)

$$I = \sqrt{\sum_i (I_i / C_i)^2} \quad \text{Eq. 14}$$

{	I_k	: Ripple current effective value of the k^{th} component.
	C_k	: Frequency coefficient of k component. (please refer to the multiplier for ripple current of the product catalog)

For industrial equipment and others, forced air cooling by a fan and cooling of the bottom of the capacitor by water cooling are carried out. In such a case, it is necessary to calculate using a more accurate

ALUMINUM ELECTROLYTIC CAPACITOR- TECHNICAL NOTES

thermal model of the capacitor. Please inquire about details.

(3) Temperature Rise by Ripple Current and Estimated Life

We have experimentally researched the effects on aluminum electrolytic capacitors' lifetime by ripple currents and derived the acceleration factor through the parameter of the initial temperature rise by ripple currents, as shown in equation 15. In addition, since the lifetime is impacted by ripple currents, as well as electrolyte depletion, life does also depend on the product (element-size). We introduced the factor k to take into account this effect to the lifetime formula.

$$L = L_0 \times 2^{\left(\frac{\Delta T_0}{10-k\Delta T_0} - \frac{\Delta T_e}{10-k\Delta T_e}\right)} \quad \text{Eq. 15}$$

{	L	: Estimated lifetime (hours)
	L_0	: Specified lifetime (Lifetime when rated ripple current is applied) (hours)
	ΔT_0	: Heat rise at the core when rated ripple current is applied (°C)
	ΔT_e	: Heat rise at the core by ripple current at actual use (°C)
	k	: 0.25 (SMD / Lead wire type), 0.17 (Snap-in type), 0.00 (Screw terminal type)

5-3 Applied Voltage and Life

For products of large size and electrolyte retention, such as snap-in or screw terminal type, not only dry-up of electrolyte but also consumption of electrolyte due to leakage current flowing when voltage is applied also affect lifetime. The life calculation formula incorporating this effect is shown in Equation 16.

$$L = L_0 \times \text{Min}[\kappa, 5(\kappa - 1)(1 - V/V_0) + 1] \quad \text{Eq. 16}$$

Where $\text{Min}[A, B]$ means taking a smaller value of A and B .

{	L	: Lifetime when voltage V is applied (hours)
	L_0	: Lifetime when rated voltage V_0 is applied (hours)
	V	: Actual working voltage of capacitor (V)
	V_0	: Rated voltage of capacitor (V)
	κ	: Size coefficient (Table 3)

Equation 16 means that when it is used at 80% or less of the rated voltage, the lifetime of the capacitor is κ times as large as when the rated voltage is applied.

This voltage derating can apply only to snap-in and screw terminal types with a rated voltage of 160 V or more. It can not apply to a small-size capacitor such as SMD and lead wire type or those with a rated voltage of 100 V or less. This is because the dry-up effect is larger for smaller-size products, and voltage dependence is not observed for low-voltage products.

ALUMINUM ELECTROLYTIC CAPACITOR- TECHNICAL NOTES

Table 3: Size coefficient (k)

Applicable Series	Product length [mm]	Size coefficient (k)
USG, USH, USK, MXG, MXH, MXK, MXT, HXG, VXG, VXH, VXK, VXT, GXH, GXK, NXG, NXH, NXX, THC, THH, THK, HXH, HXK, KXF, SXG	20	1.75
	25	1.91
	30	2.12
	35	2.33
	40	2.54
	45	2.75
	50	2.95
	55	3.16
	60	3.37

※Please contact us for other series and product lengths not listed.

5-4 The life calculation formula for each product type

With consideration of the lifetime behavior as explained in sections 5.1 to 5.3, our life calculation formulas are as follows.

< SMD / Lead wire type (maximum category temperature 105 °C or less) >

1) Products specified endurance with applying rated ripple current

$$L = L_0 \cdot 2^{\frac{T_{max}-T_a}{10}} \cdot 2^{\left(\frac{\Delta T_0}{10-0.25\Delta T_0} - \frac{\Delta T_e}{10-0.25\Delta T_e}\right)} \quad \text{Eq. 17}$$

2) Products specified endurance with applying rated DC voltage

$$L = L_0 \cdot 2^{\frac{T_{max}-T_a}{10}} \cdot 2^{-\frac{\Delta T_e}{10-0.25\Delta T_e}} \quad \text{Eq. 18}$$

{	L	: Estimated lifetime (hours)
	L_0	: Specified lifetime (hours)
	T_{max}	: Maximum category temperature (°C)
	T_a	: Ambient temperature (°C)
	ΔT_0	: Heat rise at the core when rated ripple current is applied (°C)
	ΔT_e	: Heat rise at the core of the capacitor by ripple current (°C)

* If applicable below, please contact us.

- The case that heat rise (ΔT_e) exceeds 20 °C by applying ripple current.
- Product whose maximum category temperature (T_{max}) exceeds 105 °C.

ALUMINUM ELECTROLYTIC CAPACITOR- TECHNICAL NOTES

< Snap-in type > (Not applicable to HXG series and THC series)

1) Product with rated voltage of 100 V or less

$$L = L_0 \cdot 2^{\frac{T_{max}-T_a}{10}} \cdot 2^{\left(\frac{\Delta T_0}{10-0.17\Delta T_0} - \frac{\Delta T_e}{10-0.17\Delta T_e}\right)} \quad \text{Eq. 19}$$

2) Products with a rated voltage of 160 V or more

$$L = L_0 \cdot 2^{\frac{T_{max}-T_a}{10}} \cdot 2^{\left(\frac{\Delta T_0}{10-0.17\Delta T_0} - \frac{\Delta T_e}{10-0.17\Delta T_e}\right)} \times \text{Min}[\kappa, 5(\kappa - 1)(1 - V/V_0) + 1] \quad \text{Eq. 20}$$

{	L	: Estimated lifetime (hours)
	L_0	: Specified lifetime (hours)
	T_{max}	: Maximum category temperature (°C)
	T_a	: Ambient temperature (°C)
	ΔT_0	: Heat rise at core when rated ripple current is applied (°C)
	ΔT_e	: Heat rise at core of the capacitor by ripple current (°C)
	V	: Actual working voltage of capacitor (V)
	V_0	: Rated voltage of capacitor (V)
	κ	: Constant (depending on product size and product type)

* If applicable below, please contact us.

- The case that heat rise (ΔT_e) exceeds 30 °C by applying ripple current.
- Product whose maximum category temperature (T_{max}) exceeds 105 °C.
- HXG series

5-5 The Results of the Lifetime Calculation (Expected Lifetime)

Please note that the results of the expected lifetime derived from the formulas in this document are not guaranteed but are considered as a reference for the application design. Please select our products whose expected lifetime should have enough safety margin for the required lifetime of your design. In addition, if the expected lifetime calculation results in a value > 15 years, please use 15 years as the maximum life expectancy. If you need longer life, please contact us.

ALUMINUM ELECTROLYTIC CAPACITOR- TECHNICAL NOTES

6. Caution for Proper Use

6-1 General Cautions

For basic precautions on using aluminum electrolytic capacitors, please refer to our product catalog.

6-2 Charge and Discharge Application

Performance deterioration of aluminum electrolytic capacitor is accelerated by repeated charge and discharge. Deterioration is accelerated as the charge-discharge voltage is higher, the charge-discharge resistances are lower, the charge-discharge cycle is shorter, and the ambient temperature is higher. Safety vent operation and rupture may occur depending on charge-discharge conditions for devices which has frequent regeneration such as servo amplifier and which have large ripple voltage amplitude such as lighting. Therefore, it is required to select the proper product considering its operating condition.

Factors causing characteristic deterioration and failure of a capacitor by charge and discharge include heat generation and increase in leakage current due to charge-discharge, deterioration and local destruction of the anodized film, cathodic foil formation due to discharge and gas generation with formation, and so on.

1) Energy Dissipation by Charge and Discharge Current

For capacitors subjected to frequent charge and discharge cycles through very low discharge resistance (less than a few ohms) such as flash units for cameras and welding machines, Energy dissipation due to high charge-discharge current is the main factor in performance deterioration.

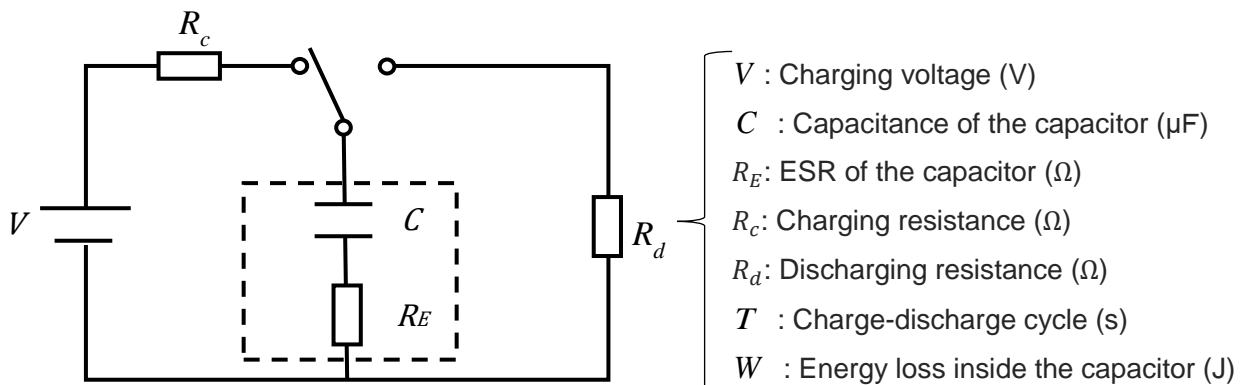

Fig. 22 Schematic diagram of charging-discharging circuit

Due to its structure, the aluminum electrolytic capacitor has an internal resistance R_E shown in Fig. 22. The internal resistance is due to the characteristics of the electrolyte, electrode foils and oxide film. Power loss W due to the internal resistance occurring at discharge is indicated as equation 21.

$$W = \frac{1}{2} CV^2 \left(\frac{R_E}{R_E + R_c} + \frac{R_E}{R_E + R_d} \right) \frac{1}{T} \quad \text{Eq. 21}$$

Heat rise through this power loss causes the internal temperature of the capacitor to increase. This temperature increase continues until thermal equilibrium is reached between the heat rise and heat

ALUMINUM ELECTROLYTIC CAPACITOR- TECHNICAL NOTES

radiation from capacitor surface.

As internal temperature increases, the oxide film on the anode foil progressively deteriorates, accelerating degradation of the capacitor, which is apparent in an increase of leakage current and internal resistance. Therefore, capacitors must be used that are designed with lower internal resistance to minimize heat rise and promote long life when used with applications that have low discharge resistance and involve frequent charge and discharge. When the charge and discharge current is extremely high, a capacitor must be used that is designed to lower dielectric loss, and with low internal resistance, as dielectric loss of the oxide film on the anode foil is another factor in performance deterioration.

2) Capacitance Reduction and Inner Pressure Increase by Charge and Discharge

When the standard aluminum electrolytic capacitor is subjected to frequent and repeated on-off cycles, the inner pressure is increased by the gases generated from the electric reaction of the electrolyte on charging, and the cathode foil forms on discharging.

This phenomena is caused by the rectifying property (polarity) of the aluminum oxide films. Due to this property, the aluminum electrode has the withstanding voltage in the case that the potential of the inner metal layer is higher than that of the electrolyte on the electrode, has no withstanding voltage in the opposite case that the metal layer potential is lower than that of the electrolyte. Therefore, the aluminum electrolytic capacitor charging is to be accompanied by the electric reaction of the electrolyte on the cathode electrode, and as a result, it goes to the equilibrium that the anode foil charge is not equal (larger) to the cathode foil charge. Fig. 23 (a) is the illustration of this state.

Subsequently, when this charging capacitor is discharged, the positive and negative charges are neutralized, but the amount of the anode foil charge is larger than that of the cathode foil, and then the capacitor holds the residual charge to appear the residual voltage V_{res} between the spacer paper part and the metal parts in the anode and cathode foils (these two metal parts are in short-circuit on discharging). Fig. 23 (b) shows this situation and it is that the forward voltage (withstanding polarity) is applied to the cathode foil. If this forward voltage is over the forming voltage of the cathode foil, the electric current flows via the thin oxide film with forming the new oxide film and generating gases, and the cathode capacitance is reduced. As a result, the capacitor's capacitance (serial capacitance of the anode foil and the cathode foil) is reduced, too.

When high slew-rate loads such as a rapid charge-discharge are applied to aluminum electrolytic capacitors, the various electrochemical reactions on the cathode foil bring the gas generation and the capacitance reduction of the cathode foil. For this reason, applications with frequent charge-discharge loads need the specially designed capacitor with a countermeasure for a charge-discharge load. If this is a concern, please consult us for a specific solution.

ALUMINUM ELECTROLYTIC CAPACITOR- TECHNICAL NOTES

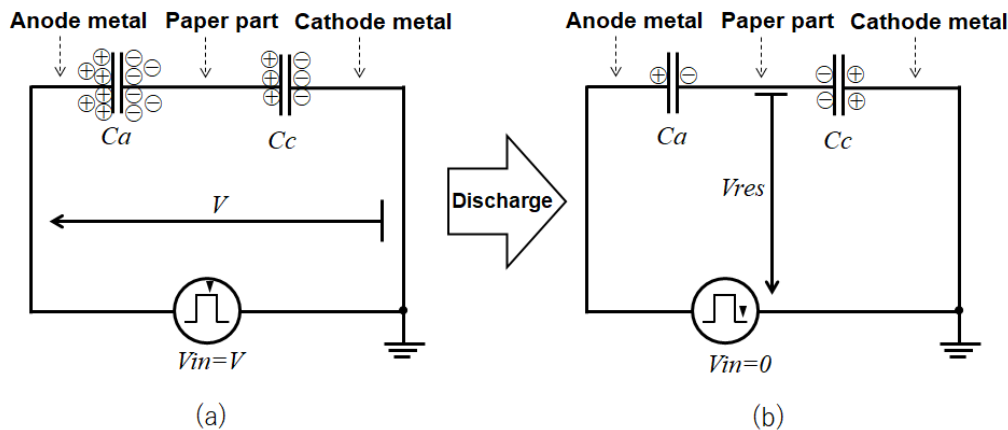

Fig. 23 The charge transformation on charge and discharge

6-3 Inrush Current

Current (inrush and starting current) is a large current temporarily flowing when power is applied to a device using a motor or having a smoothing capacitor with large capacitance. The current is much larger than the steady state current value. Generally, a single-shot / short-time large current load at startup is not a problem for the capacitor, but in the case of a circuit in which a large current load is frequently applied to a capacitor, heat generation of the capacitor may exceed the allowable value or abnormal heat may occur at the connection between the internal electrode and the lead terminal or the connection to the external terminal.

Especially for automotive applications, the input capacitors of ECU (Electric Control Unit) are charged by the car battery with several-hundreds Amps current, and the peak value of this inrush current is determined by the line impedance of the harness which connects the ECU and the battery. The inrush current endurance of such a capacitor should be considered for the estimated peak current values.

6-4 Overvoltage Application

When voltage exceeding the rated voltage of the capacitor is applied, current flows and formation of oxide film progresses until withstand voltage of the anode matches the applied voltage, and it will cause decrease in the capacitance and increase in $\tan \delta$ (ESR). Since this reaction is associated with heat generation and gas generation, it may result in safety vent operation of the capacitor due to rise in internal pressure or internal short-circuit failure.

ALUMINUM ELECTROLYTIC CAPACITOR- TECHNICAL NOTES

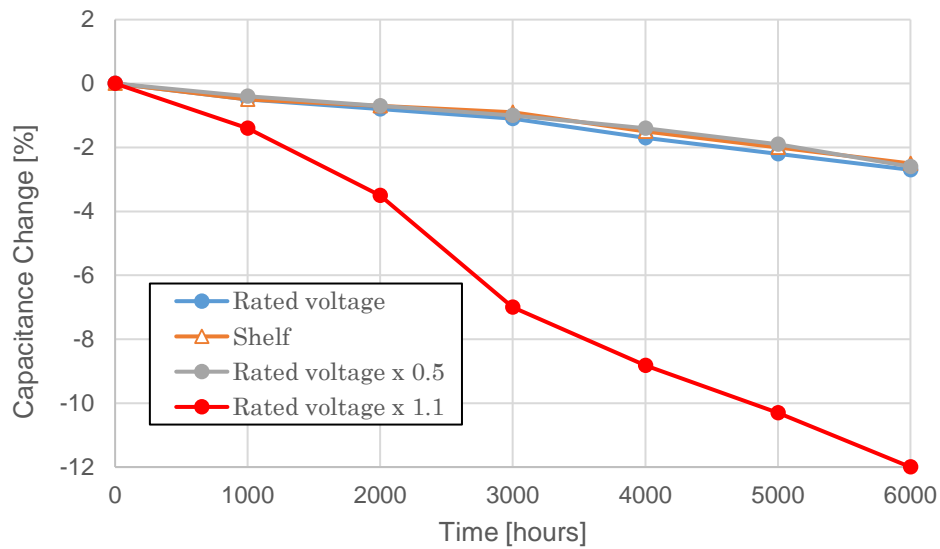

Fig. 24 Capacitance change when overvoltage is applied

6-5 Reverse Voltage Application

Aluminum electrolytic capacitors have a polarity. When reverse voltage is applied, current flows and formation of oxide film progresses until withstand voltage of the cathode matches the applied voltage, resulting in decrease in capacitance, increase in $\tan \delta$ (ESR), and gas generation. When high reverse voltage is applied, safety vent of the capacitor may be activated due to internal pressure rise caused by gas generation.

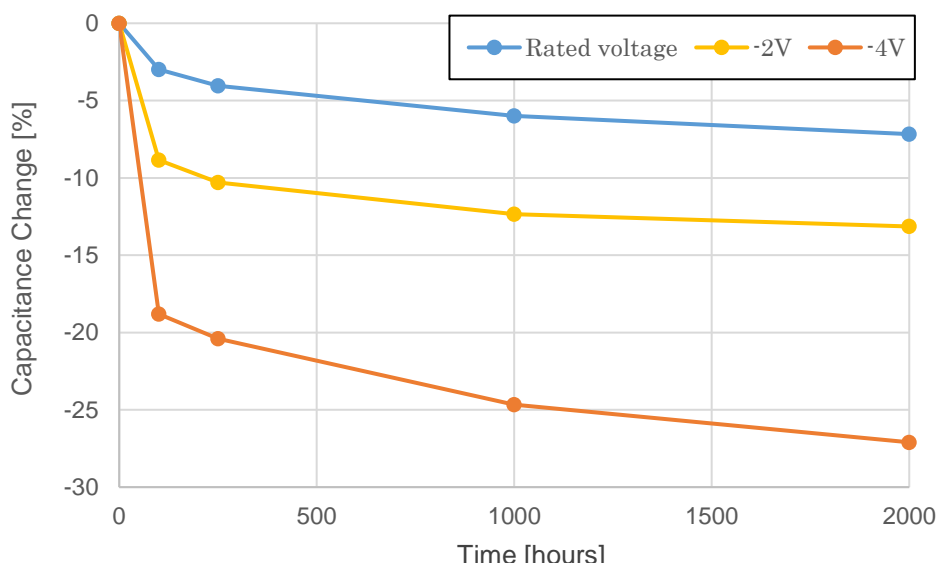
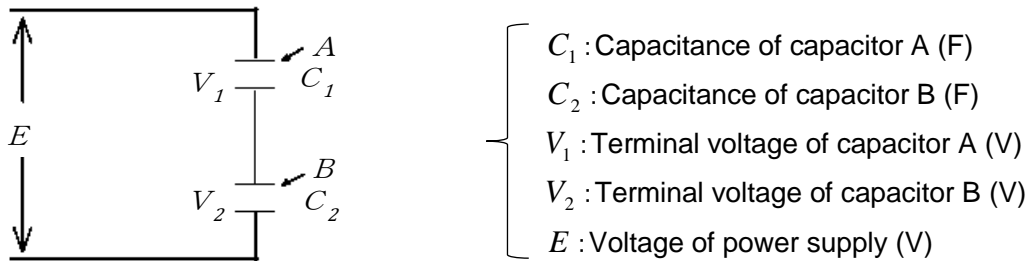

Fig. 25 Capacitance change when reverse voltage is applied

ALUMINUM ELECTROLYTIC CAPACITOR- TECHNICAL NOTES

6-6 Series / Parallel Connection

1) Series Capacitor Connection



C_1 : Capacitance of capacitor A (F)
 C_2 : Capacitance of capacitor B (F)
 V_1 : Terminal voltage of capacitor A (V)
 V_2 : Terminal voltage of capacitor B (V)
 E : Voltage of power supply (V)

Fig. 26 Series capacitor connection

When two capacitors are connected in series, voltage at terminals of each capacitor on charging is applied in reverse proportion to the capacitance of each capacitor as shown below.

$$V_1 = E \times \frac{C_2}{C_1 + C_2} \quad \text{Eq. 22}$$

$$V_2 = E \times \frac{C_1}{C_1 + C_2} \quad \text{Eq. 23}$$

$$E = V_1 + V_2 \quad \text{Eq. 24}$$

This means that voltage applied to either capacitor may be over the rated voltage to cause safety vent operation if capacitance values of them are much different. After the completion of charging, terminal voltage on each capacitor varies with the level of leakage current. Then over voltage may be applied to the terminals on either capacitor if another capacitor has high leakage current, which possibly causes safety vent operation.

To prevent difference in terminal voltage values, it is useful to put Voltage Distribution Resistors as shown in Fig. 27 and to select two capacitors with minimal difference in capacitance. We recommend to use the capacitors in same production lot. Follow Eq. 25 to use Voltage Distribution Resistors.

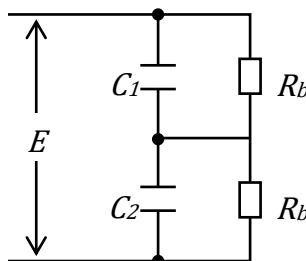

Fig. 27 Series capacitor connection with balance resistance

ALUMINUM ELECTROLYTIC CAPACITOR- TECHNICAL NOTES

$$R_b = 2 \times \frac{V_0}{I_{leak}} \quad \text{Eq. 25}$$

$$\left\{ \begin{array}{l} V_0 : \text{Rated voltage (V)} \\ I_{leak} : \text{Leakage current (mA)} \\ R_b : \text{Balance resistance (\Omega)} \end{array} \right.$$

Note: In a circuit with a large charge / discharge load, there is a case resulting in failure. Failure causes because leakage current of the capacitor increases over time, voltage balance may be lost, and a voltage exceeding the rated voltage may be applied to one of the capacitors, even if a balancing resistor is attached.

2) Parallel Capacitor Connection

When connecting capacitors in parallel, as shown in Fig. 28 (a), since wiring resistance of individual capacitors will be different, current flows preferentially to the capacitor with small wiring resistance and its heat generation increases. In such a case, deterioration of the characteristics (capacitance reduction, ESR increase, etc.) of the capacitor located at a specific position (place where the wiring resistance is low) is accelerated leading to breakdown, and there is a possibility that the expected life of the device may not be satisfied. Therefore, in the case of parallel connection, please design the circuit so that it becomes equal-length wiring as shown in Fig. 28 (b).

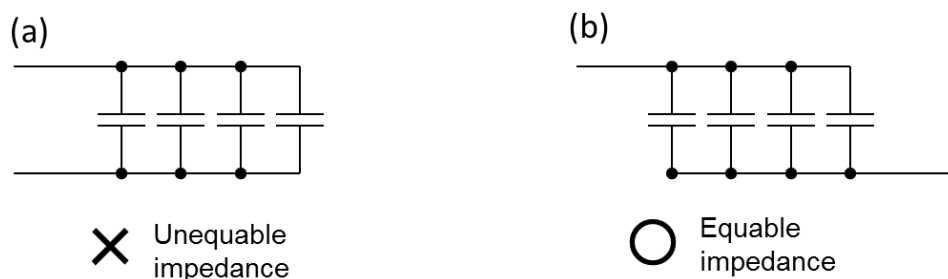

Fig. 28 Wiring for parallel connection of capacitors

6-7 Recovery Voltage

When charged aluminum electrolytic capacitor is discharged by shorting the terminals and left open for a while, the voltage between terminals of the capacitor rises again. This increased voltage is called “recovery voltage”. The mechanism of this phenomenon is explained as follows.

In general, the structure of a capacitor is as shown in Fig. 29, with a dielectric substance between two electrodes. Dielectric of an aluminum electrolytic capacitor is an oxide film formed on surface of aluminum foil by forming process. When voltage is applied to the dielectric, polarization occurs due to dielectric effect.

ALUMINUM ELECTROLYTIC CAPACITOR- TECHNICAL NOTES

The polarization does not immediately respond to the electrical field and may delay by the elastic viscosity of the molecules. There are various types of polarization, including space charge polarization, atomic polarization, and electronic polarization.

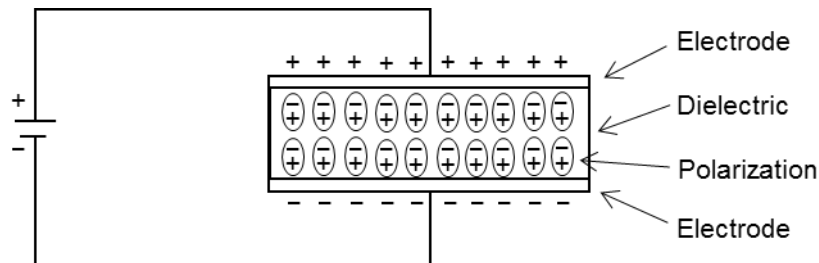

Fig. 29 Dielectric polarization during capacitor charging

When voltage is applied to the capacitor, the electric field is induced in the dielectric of the capacitor. Then, this electric field operates the dielectric to induced polarization in the dielectric. This phenomenon is called "Dielectric Polarization." For aluminum electrolytic capacitors, the dielectric is the aluminum oxide film in which the dielectric polarization contains slow-response polarizations called "Space charge polarization" or "Interfacial polarization" and also the fast-response polarizations, such as electric polarization or ionic polarization. The origin of the space charge polarization is the positive-negative ions which are not contributed to the electric current (leakage current) but can move in the oxide film. These ions relocations by electric field generate the spatial charge distribution to form the macroscopic polarization. The relaxation time of the space charge polarization has a wide distribution, and the components with the long relaxation time occur the regeneration voltage phenomena.

Recovery voltage peaks between one to three weeks after the terminals are disconnected, and then gradually decreases. Recovery voltage tends to be higher in larger capacitors such as capacitors with screw terminals and self-supporting terminals.

If recovery voltage is present, shorting the terminals will create a spark. This could frighten a person working with the capacitor, and there is also the risk of damaging low-voltage devices in the circuit such as CPUs and memory. To prevent this from happening, it is recommended to discharge the capacitor with a resistor of about 1 k Ω before use. We have also dealt with the countermeasure packaging against recovery voltage, so please consult us.

6-8 Use at High Altitude

When an aluminum electrolytic capacitor is used for the equipment used in high altitudes such as mountains and aircraft, although it is assumed that the pressure inside the capacitor will be relatively higher due to a decrease in the outside air pressure, there is no problem with the sealing performance of the capacitor for use in the atmosphere up to about 10,000m. Also, there is no problem in terms of sealing performance for use under a vacuum. However, since temperature decreases as altitude increases, please

ALUMINUM ELECTROLYTIC CAPACITOR- TECHNICAL NOTES

check the operation of the equipment taking into consideration that aluminum electrolytic capacitor has the property of decreasing capacitance and $\tan \delta$ (ESR) at low temperature. For reference, Table4 shows the relationship between altitude and temperature / atmospheric pressure.

Table 4 Altitude and temperature / atmospheric pressure

Altitude [m]	Temperature [°C]	Pressure [hPa]
0	15.0	1013.3
2,000	2.0	794.9
4,000	-11.0	616.3
6,000	-24.0	471.7
8,000	-37.0	355.9
10,000	-50.0	264.3

Also, the heat dissipation from the capacitor to the outside air decreases (the thermal resistance increases) at high altitudes or under reduced pressure and vacuum condition, so it is necessary to apply a certain derating to the rated ripple current value of the catalog. For details, please contact us.

6-9 Use at low temperature

As explained in sections 3-6, low temperatures increase the impedance, and ESR and reduce the capacitance remarkably due to the cold-resistivity of electrolytes. When chopper converters composed of semiconductor switches, inductors, and aluminum electrolytic capacitors operate under a low temperature, the surge voltage is generated in the mode that the inductor storage energy is translated to the aluminum electrolytic capacitors. It is known that this surge voltage sometimes breaks the semiconductor switch of the boost type of PFC (power factor correction) circuit on the start-up operation in low temperatures. To avoid this failure, please take care of the circuit design and assessments (e.g. surge voltage, EMI noise, etc.) if the designed application is used at a considerably low temperature.

7. Product Selection for Application

Aluminum electrolytic capacitors have the feature of high capacitance per unit volume and lower cost per capacitance compared with other capacitors and are mainly used for smoothing power supply. Our lineup of aluminum electrolytic capacitors includes products with various characteristics such as small size, high ripple current, low impedance (low ESR), long life, low height / thin diameter, high temperature, overvoltage correspondence, and vibration proof. Please select the capacitor suitable for the intended use and required performance.

Points of product selection and recommended products for typical applications are shown below.

ALUMINUM ELECTROLYTIC CAPACITOR- TECHNICAL NOTES

1) For Input Smoothing Circuit of Power Supply

Input smoothing capacitor of power supply is positioned after diode that commutates commercial AC power supply (50 Hz / 60 Hz), plays a role of smoothing (DC transducing) pulsating current of full-wave / half-wave rectified by the diode. Small size, high capacitance, high ripple current, high reliability, and safety are required for input smoothing capacitor. In switching power supply, since ripple current corresponding to switching frequency of several tens of kHz to several hundred kHz is also applied to the input smoothing capacitor, the low impedance at this frequency is also an important factor. When used for inverter smoothing circuits, especially servo amplifiers that repeat charging and discharging, optimum product selection or individual design considerations that can withstand frequent and large voltage fluctuations are required.

Table 5 Recommended series for input smoothing of power supply

Type	85 °C		105 °C			125 °C
	Standard	Miniaturized	Standard	Miniaturized	Long-life	Standard
Lead wire	PK	-	PX	QXW, HXW	CXW, BXW, LXW, BXG	EXW
Snap-in	USG	USH, USK	MXG	MXH, MXK, MXT	VXH, VXK, VXT, GXH, GXK, NXH, NXK	THH, THK

2) For Output Smoothing Circuit of Power Supply

Output smoothing capacitor of power supply plays an important role to stabilize the output voltage. High ripple current and low impedance (low ESR) characteristics at switching frequency of several tens of kHz to several hundred kHz are required for output smoothing capacitor of switching power supply. In addition, depending on installation location and design life of power supply equipment, there are cases where low-temperature or high-temperature correspondence, long life characteristics of capacitors are required and where surface mounting of capacitors to miniaturize equipment and automate production line are required.

Table 6 Recommended series for output smoothing of power supply

Type	85 °C	105 °C			125 °C
	Standard	Standard	Low Z (ESR)	Long-life	Low Z (ESR)
SMD	-	-	TZV, TPV	TLV, TRV, TNV	THV, TGV, TAV
Lead wire	PK	PX, YXJ, YXS	ZLH, ZLJ, ZLS, ZLQ, JXF		RXF, RXL

ALUMINUM ELECTROLYTIC CAPACITOR- TECHNICAL NOTES

3) For Control Circuit

For control circuit capacitors, those with a relatively small capacitance and a small size (low height) compared to input and output capacitors are used. In a case placed near heating parts due to high density mounting of electronic equipment, long life is required for capacitors.

Table 7 Recommended series for control circuit

Type	105 °C	
	Low height	Long-life
SMD	TZV, TKV, TPV	TRV, TNV, TLV
Lead wire	-	YXM

4) For Strobe Flash

Strobe flash capacitors are products specialized for strobe flash lighting and designed to increase its energy density per volume to the limit. Therefore, please note that it can not be used for purposes other than the main capacitor of strobe flash. For product specifications etc., it will be individual design, so please contact us for details.

In addition to the products introduced above, we are offering wide range of series that correspond to various applications, please refer to our product catalog for details. We also provide parameter search (product search) based on required performance on our website, so please use it in conjunction.