

QFN Mounting Manual

All information contained in these materials, including products and product specifications, represents information on the product at the time of publication and is subject to change by Renesas Electronics Corp. without notice. Please review the latest information published by Renesas Electronics Corp. through various means, including the Renesas Electronics Corp. website (<http://www.renesas.com>).

Notice

1. Descriptions of circuits, software and other related information in this document are provided only to illustrate the operation of semiconductor products and application examples. You are fully responsible for the incorporation of these circuits, software, and information in the design of your equipment. Renesas Electronics assumes no responsibility for any losses incurred by you or third parties arising from the use of these circuits, software, or information.
 2. Renesas Electronics has used reasonable care in preparing the information included in this document, but Renesas Electronics does not warrant that such information is error free. Renesas Electronics assumes no liability whatsoever for any damages incurred by you resulting from errors in or omissions from the information included herein.
 3. Renesas Electronics does not assume any liability for infringement of patents, copyrights, or other intellectual property rights of third parties by or arising from the use of Renesas Electronics products or technical information described in this document. No license, express, implied or otherwise, is granted hereby under any patents, copyrights or other intellectual property rights of Renesas Electronics or others.
 4. You should not alter, modify, copy, or otherwise misappropriate any Renesas Electronics product, whether in whole or in part. Renesas Electronics assumes no responsibility for any losses incurred by you or third parties arising from such alteration, modification, copy or otherwise misappropriation of Renesas Electronics product.
 5. Renesas Electronics products are classified according to the following two quality grades: “Standard” and “High Quality”. The recommended applications for each Renesas Electronics product depends on the product’s quality grade, as indicated below.
“Standard”: Computers; office equipment; communications equipment; test and measurement equipment; audio and visual equipment; home electronic appliances; machine tools; personal electronic equipment; and industrial robots etc.
“High Quality”: Transportation equipment (automobiles, trains, ships, etc.); traffic control systems; anti-disaster systems; anti-crime systems; and safety equipment etc.

Renesas Electronics products are neither intended nor authorized for use in products or systems that may pose a direct threat to human life or bodily injury (artificial life support devices or systems, surgical implantations etc.), or may cause serious property damages (nuclear reactor control systems, military equipment etc.). You must check the quality grade of each Renesas Electronics product before using it in a particular application. You may not use any Renesas Electronics product for any application for which it is not intended. Renesas Electronics shall not be in any way liable for any damages or losses incurred by you or third parties arising from the use of any Renesas Electronics product for which the product is not intended by Renesas Electronics.
 6. You should use the Renesas Electronics products described in this document within the range specified by Renesas Electronics, especially with respect to the maximum rating, operating supply voltage range, movement power voltage range, heat radiation characteristics, installation and other product characteristics. Renesas Electronics shall have no liability for malfunctions or damages arising out of the use of Renesas Electronics products beyond such specified ranges.
 7. Although Renesas Electronics endeavors to improve the quality and reliability of its products, semiconductor products have specific characteristics such as the occurrence of failure at a certain rate and malfunctions under certain use conditions. Further, Renesas Electronics products are not subject to radiation resistance design. Please be sure to implement safety measures to guard them against the possibility of physical injury, and injury or damage caused by fire in the event of the failure of a Renesas Electronics product, such as safety design for hardware and software including but not limited to redundancy, fire control and malfunction prevention, appropriate treatment for aging degradation or any other appropriate measures. Because the evaluation of microcomputer software alone is very difficult, please evaluate the safety of the final products or systems manufactured by you.
 8. Please contact a Renesas Electronics sales office for details as to environmental matters such as the environmental compatibility of each Renesas Electronics product. Please use Renesas Electronics products in compliance with all applicable laws and regulations that regulate the inclusion or use of controlled substances, including without limitation, the EU RoHS Directive. Renesas Electronics assumes no liability for damages or losses occurring as a result of your noncompliance with applicable laws and regulations.
 9. Renesas Electronics products and technology may not be used for or incorporated into any products or systems whose manufacture, use, or sale is prohibited under any applicable domestic or foreign laws or regulations. You should not use Renesas Electronics products or technology described in this document for any purpose relating to military applications or use by the military, including but not limited to the development of weapons of mass destruction. When exporting the Renesas Electronics products or technology described in this document, you should comply with the applicable export control laws and regulations and follow the procedures required by such laws and regulations.
 10. It is the responsibility of the buyer or distributor of Renesas Electronics products, who distributes, disposes of, or otherwise places the product with a third party, to notify such third party in advance of the contents and conditions set forth in this document, Renesas Electronics assumes no responsibility for any losses incurred by you or third parties as a result of unauthorized use of Renesas Electronics products.
 11. This document may not be reproduced or duplicated in any form, in whole or in part, without prior written consent of Renesas Electronics.
 12. Please contact a Renesas Electronics sales office if you have any questions regarding the information contained in this document or Renesas Electronics products, or if you have any other inquiries.
- (Note 1) “Renesas Electronics” as used in this document means Renesas Electronics Corporation and also includes its majority-owned subsidiaries.
- (Note 2) “Renesas Electronics product(s)” means any product developed or manufactured by or for Renesas Electronics.

Table of Contents

1. The QFN Package	1
1.1 Punching Cut Type (anvil singulation)	1
1.2 Dicing Cut Type (SAW singulation).....	2
1.3 Lead Surface Processing Specifications.....	2
2. Mounting Pads	3
2.1 Pad Structure.....	3
2.2 Mounting Pad Design Parameters.....	4
2.3 Notes on Mounting Pad Design (punching cut type).....	5
2.4 Mounting Pad Design Examples.....	5
3. Solder Paste Printing.....	6
3.1 Solder Paste.....	6
3.2 Stencils.....	7
4. Package Placement.....	10
4.1 Board Mounting Placement Conditions	10
5. Reflow Thermal Resistance	12
5.1 Storage Prior to Opening Moisture-Proof Packing	12
5.2 Storage After Opening Moisture-Proof Packing.....	12
5.3 Baking.....	12
5.4 Number of Reflow Operations.....	13
5.5 Reflow Thermal Resistance	13
5.6 Soldering Temperature.....	14
6. Cleaning	15
7. Visual Inspection	16
7.1 Overview of the QFN Package Pin End Surface.....	16
7.2 Visual Comparison of Air Reflow and Nitrogen Reflow Mounting	17
8. On Board Mechanical Stress Test Results	18
9. On Board Reliability Test Results	19
9.1 Board Mounted Thermal Cycle Test Results (punching cut type, 6 × 6 mm, 0.4 mm pitch).....	19
9.2 Board Mounted Thermal Cycle Test Results (dicing cut type, 5 × 5 mm, 0.5 mm pitch).....	19
9.3 Board Mounted Thermal Cycle Test Results (dicing cut type, 7 × 7 mm, 0.5 mm pitch).....	20
9.4 Board Mounted Thermal Cycle Test Results (dicing cut type: package shape dependency).....	20
10. QFN Reworking (removal from the mounting board).....	21

1. The QFN Package

The QFN (Quad Flat No-lead) package is a low-profile package with a leadless structure. It is appropriate for use in portable and other equipment that requires miniaturization and reduced weight. QFN packages are classified by their formation method into the punching cut and dicing cut types. The remainder of this section presents an overview of these packages.

1.1 Punching Cut Type (anvil singulation)

This type of QFN package is characterized by an individually molded body with punch press excision. Since the external leads of the package, in which each cavity is sealed with mold resin, are punched with a die, the leads can be made to protrude for extremely short distances from the package periphery.

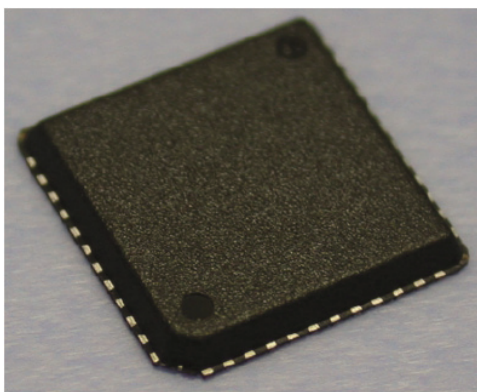

Figure 1.1 Package Top Side

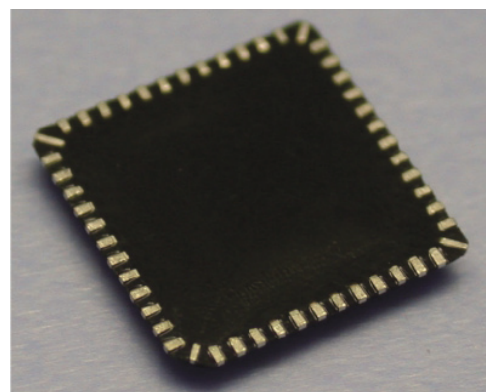

Figure 1.2 Package Underside

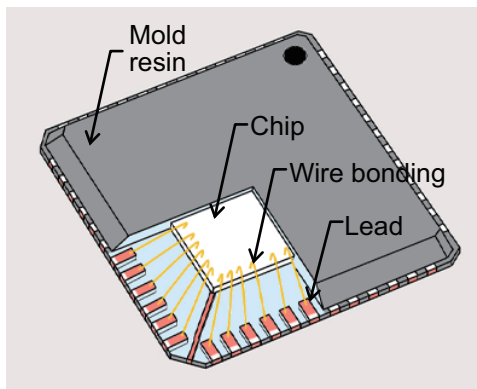

Figure 1.3 Basic Structure

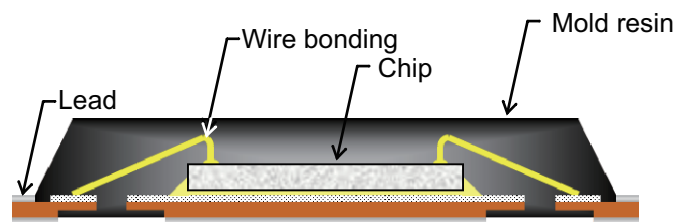

Figure 1.4 Cross-Section View

1.2 Dicing Cut Type (SAW singulation)

This type of QFN package is characterized by the package being formed by cutting with a rotating blade. Since multiple packages sealed at the same time are cut apart with a dicing blade (rotating blade), the ends of the leads and the edge of the package (cut surface) are coplanar.

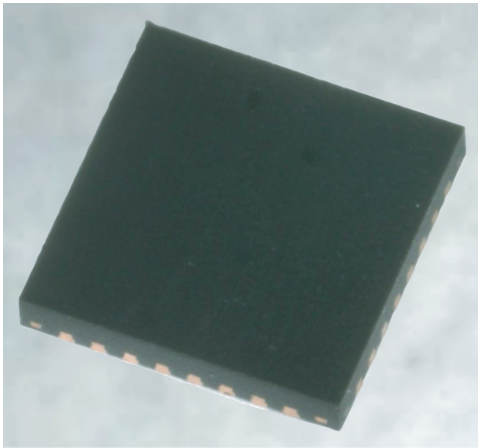

Figure 1.5 Package Top Side

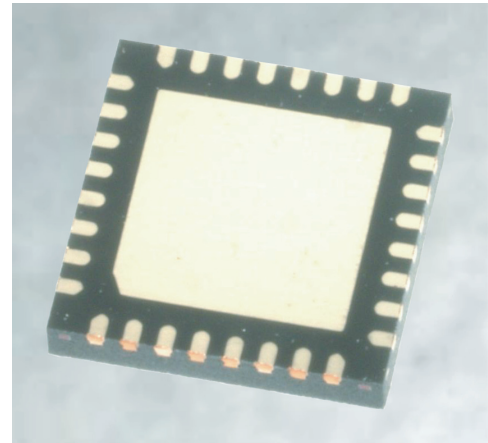

Figure 1.6 Package Underside

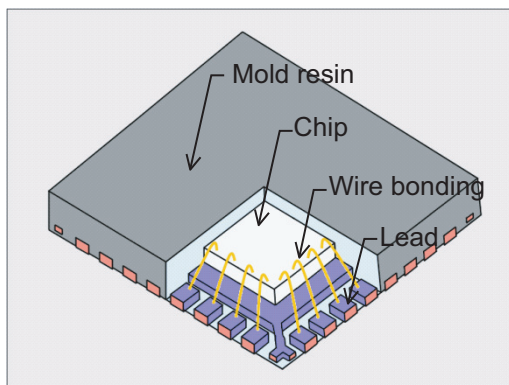

Figure 1.7 Basic Structure

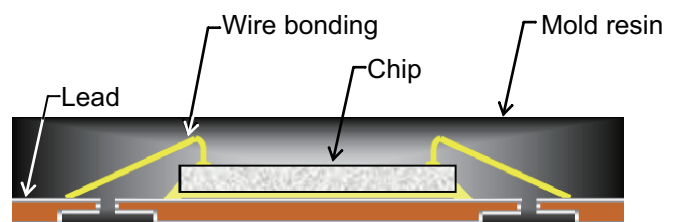

Figure 1.8 Cross-Section View

1.3 Lead Surface Processing Specifications

See the Renesas web site for the lead surface processing specifications for each QFN package code.

http://www.renesas.com/products/package/information/ic_name_list/index.jsp

2. Mounting Pads

2.1 Pad Structure

(1) NSMD Type

In this structure, the solder resist does not come over the edges of the mounting pads.

(2) SMD Type

In this structure, the solder resist comes over the edges of the mounting pads.

It is important to consider the characteristics of the lead morphology when designing printed wiring boards. Also, it is important to be aware that even if the package code is identical, there may be subtle differences in pin dimensions between individual parts.

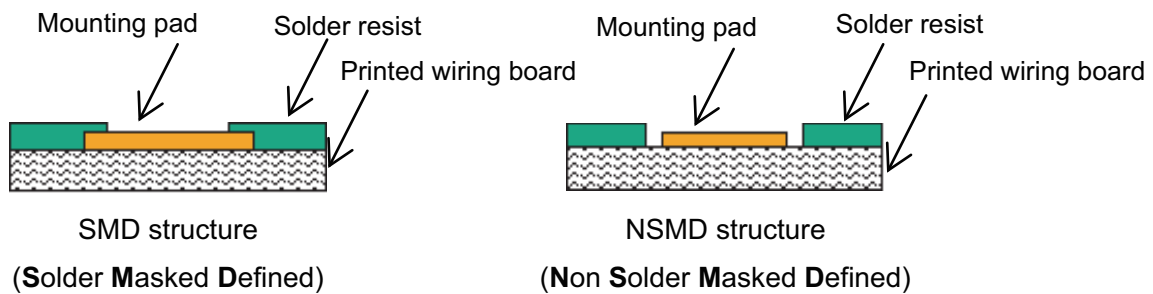

Figure 2.1 Pad Structures

2.2 Mounting Pad Design Parameters

The parameters that determine the mounting pad dimensions include the following.

- Soldering strength (β_1)
- Solder mask pattern precision and soldering visual inspectability (β_2)
- Solder bridge tolerance (γ)

The way the margins for each dimensional area are determined depends on the user’s approach to pattern design and the application the equipment will be used in. We recommend that users design QFN printed wiring board mounting pads based on the approach shown below, which is similar to that for QFP packages.

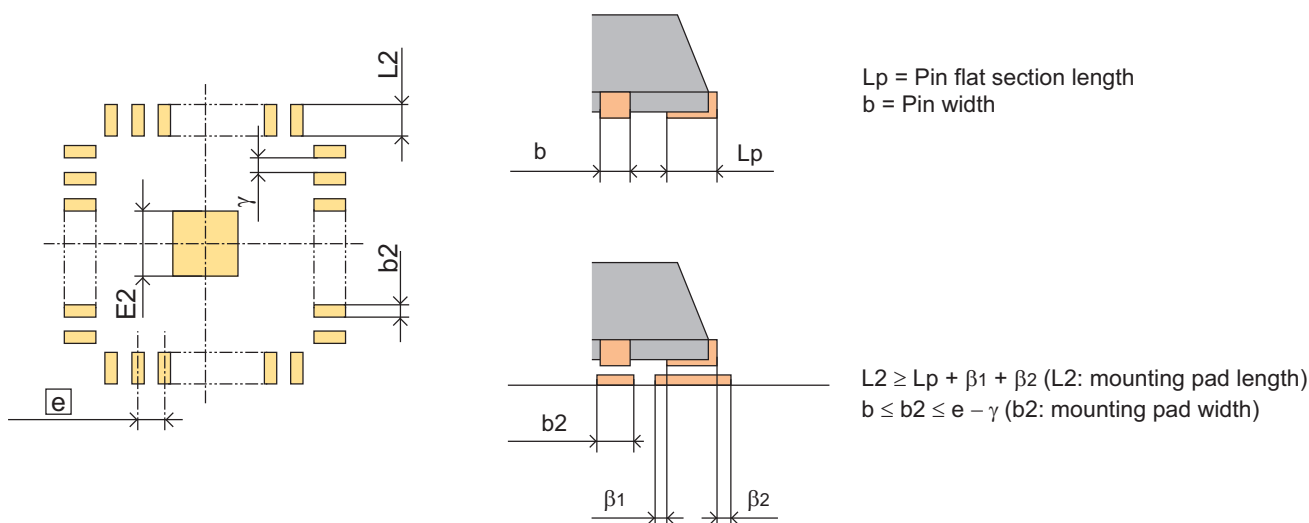

Figure 2.2 Mounting Pad Design Parameters

Table 2.1 Design Reference Values

Unit: mm

e	0.80	0.50	0.40
β_1	0 to 0.30	0 to 0.30	0 to 0.20
β_2	0 to 0.30	0 to 0.30	0 to 0.20
γ	0.10 to 0.30	0.10 to 0.30	0.10 to 0.20

- Notes:
1. The mounting pad pitch must be the linear pin spacing (pin pitch) for the package being mounted.
 2. We do not recommend mounting, on the wiring board, the lead that is exposed at the package corner (die pad hanging lead) for the punching cut type QFN package.
 3. If required, we recommend that users analyze the package end land β_1 dimension taking contact with corner exposed leads into account.

2.3 Notes on Mounting Pad Design (punching cut type)

In the punching cut type QFN package, part, or all, of the lead (hanging lead) that supports the die pad in the corner, is exposed at the package end. (We do not recommend soldering to this section.)

Since the characteristics of the semiconductor device itself may be affected if electrical contact is made to the corner pin, we recommend that users consider mounting pad design that takes contact with the corner pin section into account.

A design example for the P-VQFN48-6x6-0.4 package is presented below.

Contact with the die pad hanging lead is avoided by designing β_1 to be shorter than that for other pads.

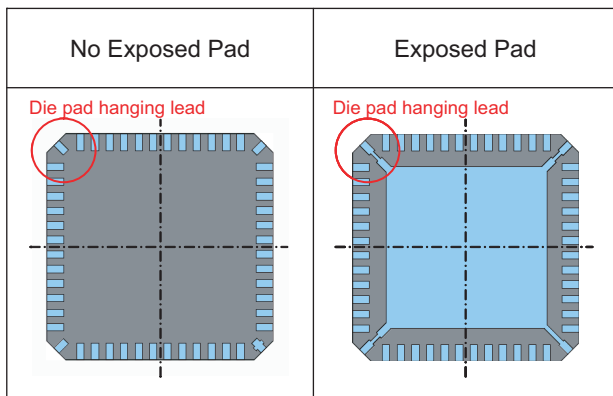

Figure 2.3 Die Pad Hanging Lead Example

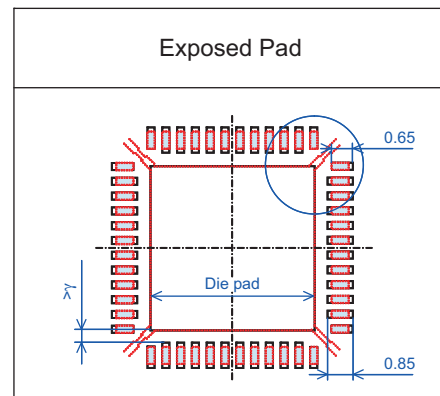

Figure 2.4 Design Example when a Die Pad is Present

2.4 Mounting Pad Design Examples

See the Renesas web site for mounting pad design examples for each QFN package code.

http://www.renesas.com/products/package/information/ic_name_list/index.jsp

3. Solder Paste Printing

3.1 Solder Paste

The main components of solder paste are solder powder and flux. The particular solder paste used should be chosen based on the usage conditions adopted.

(1) Solder Powder

Due to the desire to eliminate lead from manufacturing processes due to environment considerations, a variety of lead-free metal compositions (mainly Sn-Ag-Cu family compositions) are widely used. The different lead-free alloys are used according to the type of application and the soldering method used. Furthermore, there is a range of particle sizes in these powders, and the particle size affects the printability and other characteristics of the paste. Good results can be obtained, especially for fine-pitch (0.5 mm and under) mounting, if a fine powder with particle diameter of 40 μm or smaller and also with a narrow distribution of particle sizes is used. Note, however, that for finer powders, there are concerns that solder balls due to surface oxidation and adverse influence on the wettability may occur. Therefore, extra care is required when handling solder paste that uses solder powders such as those discussed above.

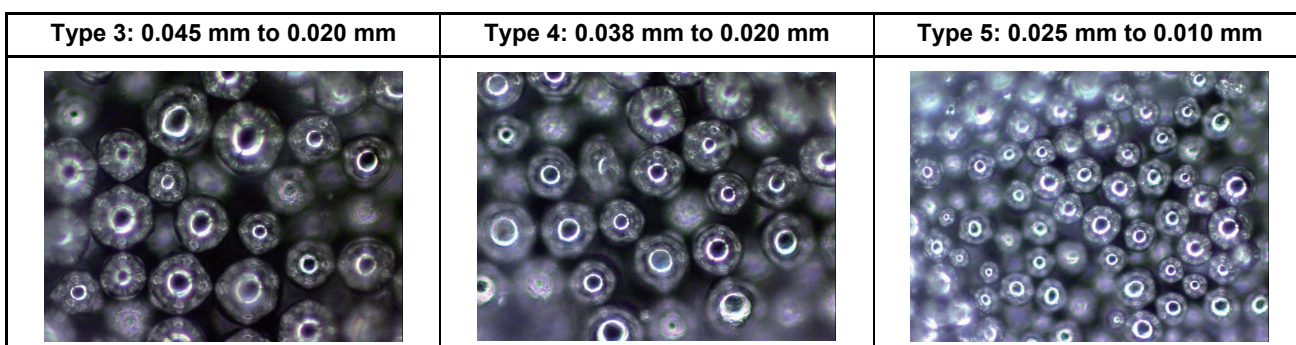

Figure 3.1 Visual Appearance of Solder Powders

(2) Flux

Flux improves solderability in the soldering process in three ways: (1) it excludes oxides from components and the pattern surface, (2) it prevents re-oxidation during soldering, and (3) it reduces the surface tension of the melted solder.

Flux includes four components that assist in soldering: tackifiers, thixotropic agents, solvents, and activators. These are used for the following purposes.

- Tackifier resins: Component mountability, metal cleaning, reoxidation prevention
- Thixotropic agents: Preventing separation of solder powder and flux, and droop prevention
- Activating agents: Metal cleaning
- Solvents: Forming the paste

There are three main types of flux: rosin fluxes, alloy resin fluxes, and water soluble fluxes. In addition, rosin fluxes are classified into three types by their degree of activation: R (rosin flux), RMA (weakly activated flux), and RA (activated flux). Table 3.1 lists their features.

Table 3.1 Flux Types and Features

Flux Type	Features
Type R, ROL Type (non-activated Rosin, Rosin Low activity levels)	These are non-activated fluxes and are noncorrosive.
Type RMA, ROM Type (Rosin Mildly Activated, Rosin Moderate activity levels)	These are mildly activated fluxes and are noncorrosive. They have superior solderability compared to the R type fluxes.
Type RA, ROH Type (Rosin Activated, Rosin High activity levels)	These are strongly activated fluxes. While they have superior solderability compared to the R and RMA type fluxes, they are strongly corrosive.

3.2 Stencils

In the stencil design, both the pin and the die pad sections must be optimized. The user must design the stencil according to the conditions under which it will be used.

(1) Pin Section

The pin sections are 100% of the mounting pad area. Also, they must be reduced by a factor of 0.9 in the width direction to prevent bridging and the amount of paste applied must be about 90% of the mounting pad area.

(2) Die Pad Exposed Sections

When designing a stencil for an exposed die pad type QFN package, the die pad section aperture design should be about 60% of the die pad. This is because if the aperture design was 100%, the package placement load would forcibly spread the solder and the mountability would be adversely affected. Below, we show evaluations for amount of forced spreading due to the load when placing packages for 100% printing and for 60% printing (divided). There is concern that, with 100% printing, the solder may be forcibly spread by the placement load and shorting to pins occur. We recommend that the user verify the results of actual placement evaluations.

Also, since the area of the die pad section is large compared to the pin area, the solder will have a large wetting force, and the amount of solder applied to this area may adversely influence the mounting height after reflow.

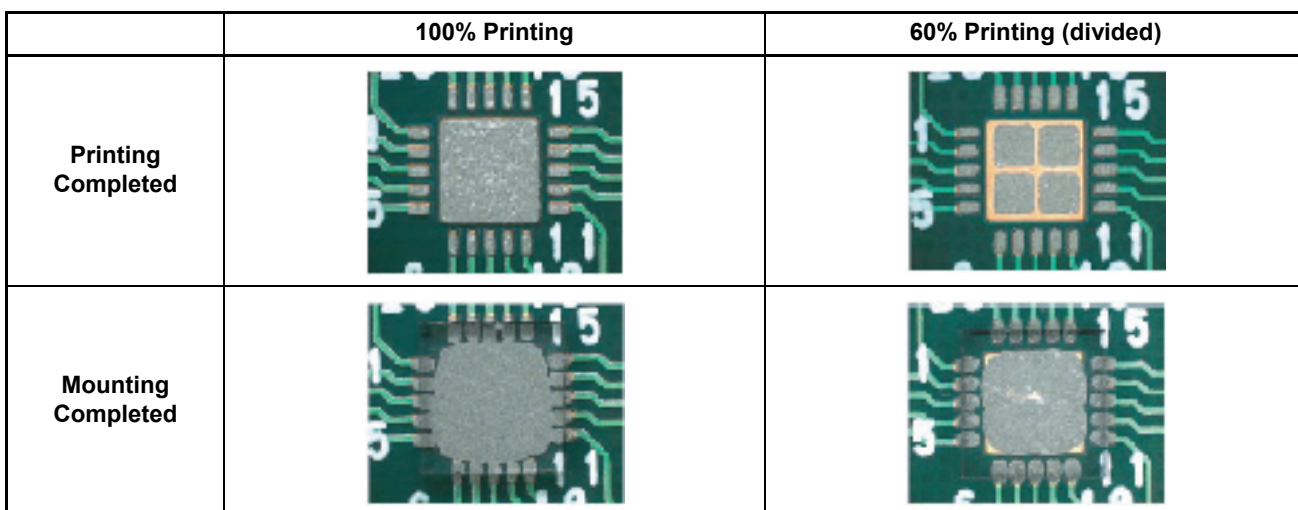

Note: Stencil thickness: 0.1 mm

**Figure 3.2 Visual Inspection Photographs of Solder Spreading at Package Placement
(Model package test using glass plates)**

The figure below shows a sample stencil design for a QFN package.

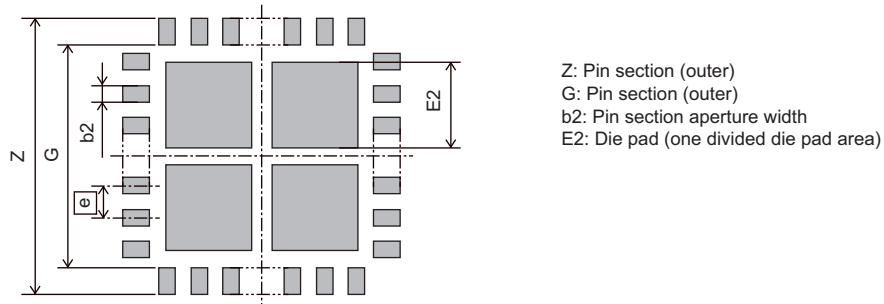

Figure 3.3 Stencil Design Example (when the die pad is divided into 4 sections)

Table 3.2 Stencil Design Example (punching cut type)

Unit: mm

Component					Stencil						
External Size	Number of Pins	Pins/Side	Pin Pitch (pin size)	Die Pad Exposure	Pin Section (100% aperture for the mounting board Cu pad area)			Die Pad (60% aperture for the mounting board Cu pad area)			Thick-ness
z	$n1$	$n2$	e ($b \times Lp$)	E1	Z	G	b2	Number of Divisions	Size (E2)	Gap	
4	20	5	0.5 (0.22 × 0.40)	—	4.60	3.00	0.25	—	—	—	0.10
7	48	12	0.5 (0.25 × 0.35)	—	7.60	6.10		—	—	—	
10	64	16	0.5 (0.22 × 0.60)	—	10.60	8.60		—	—	—	
6	48	12	0.4 (0.18 × 0.45)	4.2 × 4.2	6.60	4.90	0.20	2 × 2	1.6	0.33	0.10
8	64	16	0.4 (0.18 × 0.60)	—	8.60	6.60		—	—	—	

Table 3.3 Stencil Design Example (dicing cut type: 0.5 mm pitch)

Unit: mm

Component					Stencil						
External Size	Number of Pins	Pins/Side	Pin Pitch (pin size)	Die Pad Exposure	Pin Section (90% aperture for the mounting board Cu pad area)			Die Pad (60% aperture for the mounting board Cu pad area)			Thick-ness
z	$n1$	$n2$	e ($b \times Lp$)	E1	Z	G	b2	Number of Divisions	Size (E2)	Gap	
4	24	6	0.5 (0.25 × 0.40)	2.4 × 2.4	4.31	2.93	0.25	2 × 2	0.90	0.20	0.12
5	32	8		3.5 × 3.5	5.31	3.93		2 × 2	1.25	0.33	
6	40	10		4.5 × 4.5	6.31	4.93		3 × 3	1.12	0.28	
7	48	12		5.5 × 5.5	7.31	5.93		3 × 3	1.38	0.34	
8	56	14		6.5 × 6.5	8.31	6.93		4 × 4	1.22	0.32	
9	64	16		7.5 × 7.5	9.31	7.93		5 × 5	1.14	0.27	
10	72	18		8.5 × 8.5	10.31	8.93		5 × 5	1.29	0.31	

Table 3.4 Stencil Design Example (dicing cut type: 0.4 mm pitch)

Unit: mm

Component					Stencil						
External Size	Number of Pins	Pins/Side	Pin Pitch (pin size)	Die Pad Exposure	Pin Section (100% aperture for the mounting board Cu pad area)			Die Pad (60% aperture for the mounting board Cu pad area)			Thick-ness
\bar{z}	n1	n2	\bar{e} (b × Lp)	E1	Z	G	b2	Number of Divisions	Size (E2)	Gap	
4	24	6	0.4 (0.20 × 0.40)	2.4 × 2.4	4.31	2.94	0.20 Corner section: C0.10	2 × 2	0.90	0.20	0.10
5	32	8		3.5 × 3.5	5.31	3.94		2 × 2	1.25	0.33	
6	40	10		4.5 × 4.5	6.31	4.94		3 × 3	1.12	0.28	
7	48	12		5.5 × 5.5	7.31	5.94		3 × 3	1.38	0.34	
8	56	14		6.5 × 6.5	8.31	6.94		4 × 4	1.22	0.32	
9	72	18		7.5 × 7.5	9.31	7.94		5 × 5	1.14	0.27	
10	80	20		8.5 × 8.5	10.31	8.94		5 × 5	1.29	0.31	

4. Package Placement

4.1 Board Mounting Placement Conditions

Since the area of the resin-sealed surface and the area of the solder connection pin surface are essentially identical in QFN packages, there are cases where the solder paste is forcibly spread causing problems when placing a package on the mounting board. In particular, this phenomenon becomes significant with QFN packages that are 5 × 5 mm and smaller. The user must look into the load used during package placement, the distance the package is pressed into the solder, and other aspects, and determine appropriate mounting conditions. The tables below list results obtained in-house here at Renesas.

(1) Die pad connection present (100% solder printing of the die pad area)

Package	Placement Speed	Press-in Distance	Spring Load (Placement Load)	Solder Paste A (Viscosity: type 4)	Solder Paste B (Viscosity: type 5)
P-WQFN20-4x4-0.5 (dicing cut type)	83.3 mm/s	0.2 mm	0.6N	OK	OK
		0.4 mm	2.2N	NG	NG
		1.0 mm	2.5N	NG	NG

Note: Stencil thickness: 0.1 mm

(2) Die pad connection present (60% solder printing of the die pad area, divided into 4 sections)

Package	Placement Speed	Press-in Distance	Spring Load (Placement Load)	Solder Paste A (Viscosity: type 4)	Solder Paste B (Viscosity: type 5)
P-WQFN20-4x4-0.5 (dicing cut type)	83.3 mm/s	0.2 mm	0.6N	OK	OK
		0.4 mm	2.2N	OK	NG
		1.0 mm	2.5N	OK	NG

Note: Stencil thickness: 0.1 mm

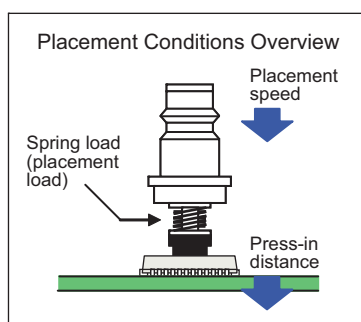

*: Evaluation standard
 OK: No paste bridges occur at package placement
 NG: Paste bridges occur at package placement

Figure 4.1 Placement Conditions

From the above, we recommend the following to suppress paste spreading at package placement.

1. Minimize the placement press-in distance.
2. Select a nozzle with a small spring load.
3. Increase the solder paste viscosity.

These are effective at achieving good results.

We recommend that the user look into the package placement conditions used based on the paste materials and package placement equipment used.

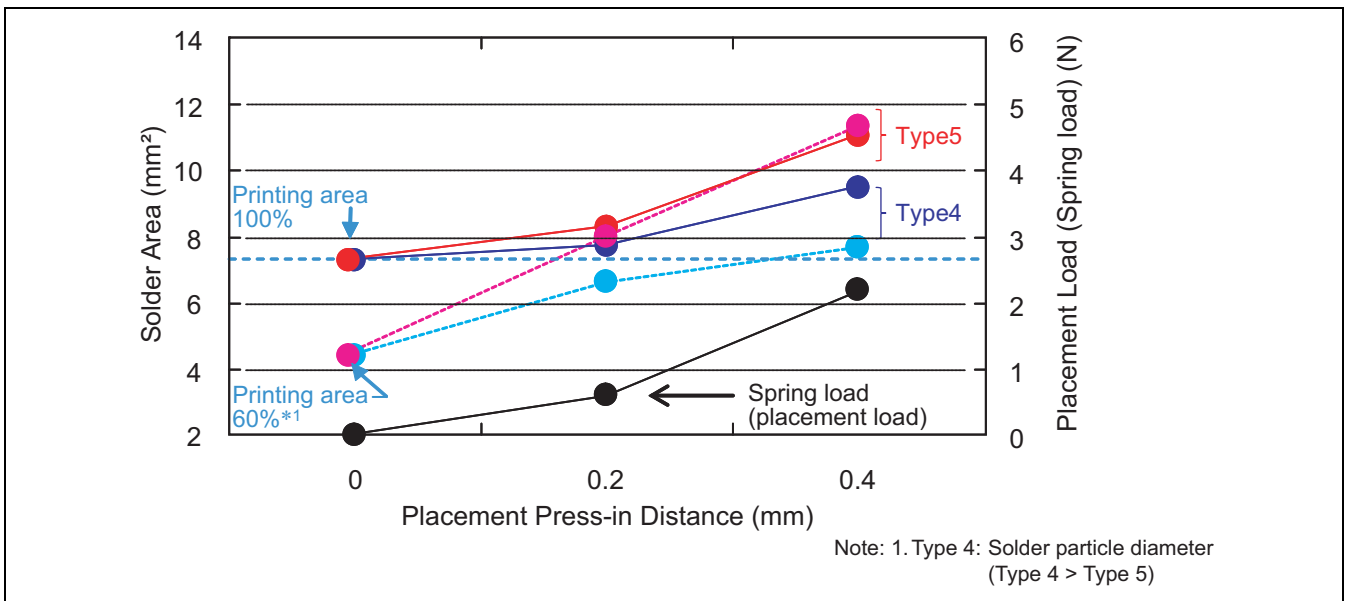

Figure 4.2 Relationship Between Placement Load and Solder Spreading

5. Reflow Thermal Resistance

5.1 Storage Prior to Opening Moisture-Proof Packing

Before opening moisture-proof packing, semiconductor devices must be stored at a temperature in the range 5 to 35°C and at a humidity under 85%RH. Note, however, that individual products may have product-specific stipulations. Thus all products must be stored only after verifying the conditions stipulated in the delivery specifications document.

5.2 Storage After Opening Moisture-Proof Packing

After opening moisture-proof packing, semiconductor devices must be stored under the following conditions to prevent moisture absorption by the packages.

Table 5.1 Sample Storage Conditions

Item	Condition	Remarks
Temperature	5 to 30°C	
Humidity	Under 70% RH	
Time	168 hours	The time from the point the packaging is opened until mounting the last device has completed.

Note, however, that individual products may have product-specific stipulations. Thus all products must be stored only after verifying the conditions stipulated in the delivery specifications documents.

5.3 Baking

Before soldering, perform the baking operation described below.

(1) Cases When Baking Is Required

- If the 30% spot on the indicator card packed with the products has changed to pink when the moisture-proof packing was opened.
- If the stipulated storage condition after opening the moisture-proof packing were exceeded.

(2) Baking Conditions

Use the following conditions for baking. Note, however, that some products have individual stipulations, and the baking (drying) processing should be performed after verifying the conditions stipulated in the delivery specifications.

During baking, use trays or other containers with adequate thermal resistance. Note that trays that are heat proof will be marked “Heat Proof” or with their thermal resistance temperature. Check this marking before performing this processing.

Table 5.2 Sample Baking Conditions

Baking Temperature	Baking Time	Repeated Baking
125°C	4 to 24 hours	No more than 96 hours total
	10 to 72 hours	No more than 96 hours total

5.4 Number of Reflow Operations

The number of reflow operations should be limited to three or fewer. Note, however, that some products have individual stipulations, and the content of the delivery specifications for the products used should be verified. Furthermore, users should verify that multiple reflow operations will not result in other problems when designing the mounting process.

After products have been mounted on dual-sided boards or by repairs, when heating for soldering for reflow or a repeated reflow, problems such as solder shorting or solder peeling may occur. The following points should be observed when setting mounting conditions.

- If moisture has been absorbed, the warping characteristics of QFN package products and the wiring board itself may change.
- The user should manage moisture absorption during reflow operations.
- The use of flux and optimization of the reflow atmosphere should be considered to assure solder coverage when remelting solder.

The mounting process must be optimized so that the temperatures of the package electrical contacts do not greatly exceed the melting point of the solder.

Furthermore, users should look into setting the temperature to be at or below the melting point of the solder.

5.5 Reflow Thermal Resistance

Although QFN package products have a thermal resistance of 260°C (maximum) to support lead-free solders as stipulated in JEDEC J-STD 020D, individual products may have a different thermal resistance temperature. Contact your Renesas sales representative for details on individual products.

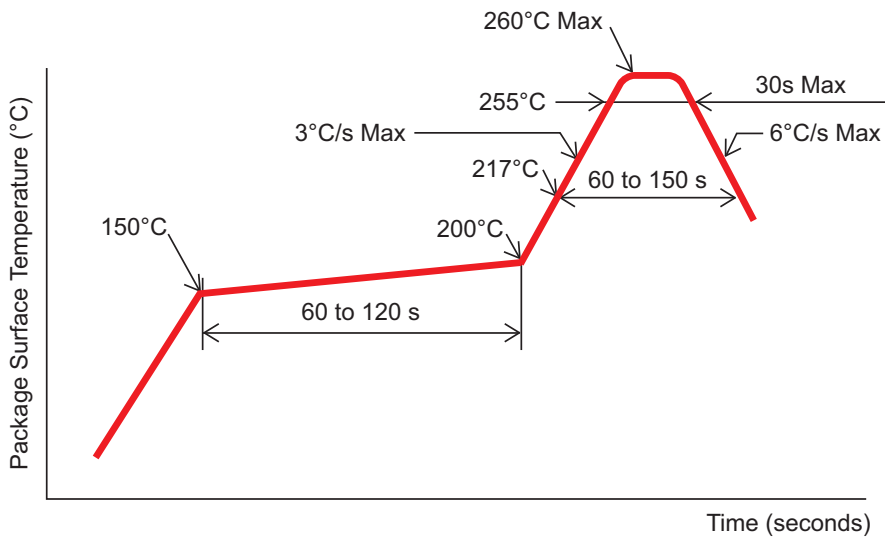

Figure 5.1 Reflow thermal Resistance Profile

5.6 Soldering Temperature

The reflow soldering temperature must be managed so that the package body temperature remains under its heat resistance temperature. The ideal temperature conditions are those such that the package contacts and pins enter the recommended temperature range for the solder paste used. Since the preheating temperature and time and the main soldering temperature and time will differ depending on the composition of the solder used and the characteristics of the flux, these must be verified in advance.

Also note that the soldering atmosphere (nitrogen atmosphere) is an item that has a large effect and influence on the soldering time and temperature and must be taken into consideration when analyzing the process condition settings.

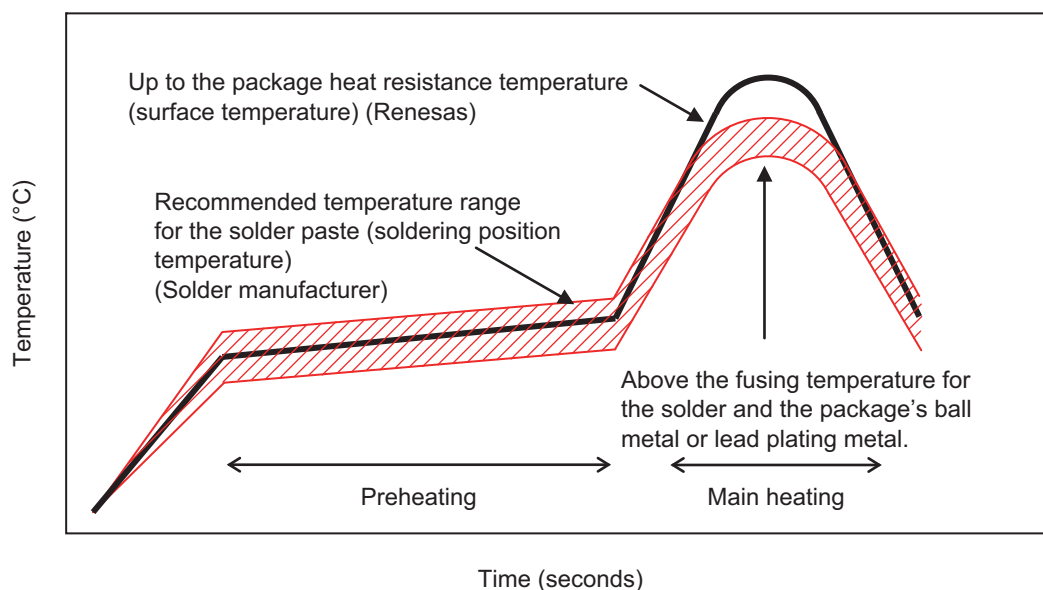

Figure 5.2 Soldering Temperature

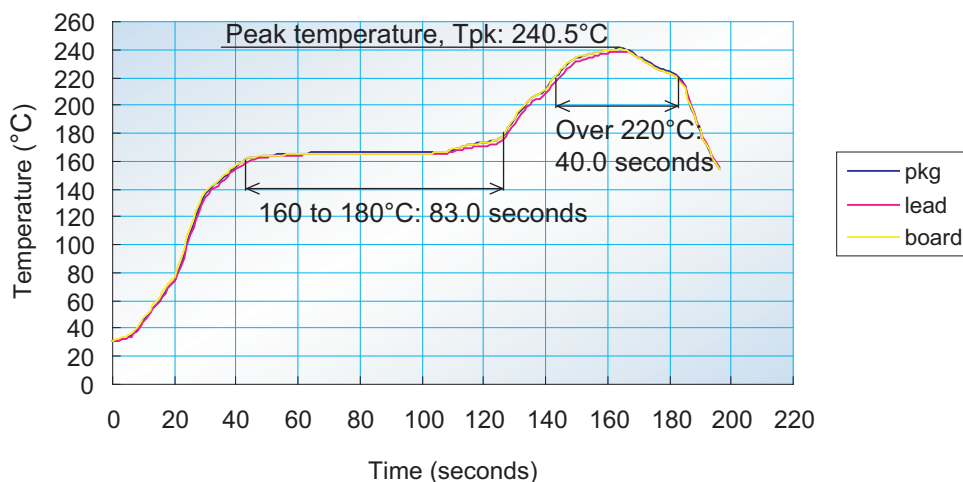

Figure 5.3 Sample Reflow Temperature Profile for Sn-Ag-Cu Solder Paste (P-WQFN32-5x5-0.5)

6. Cleaning

Previously, a wide variety of cleaning agents have been used in the flux cleaning performed after components are mounted on the printed wiring board. However there have been increasing desires for selective use of cleaning agents in consideration of environmental pollution problems, and for support of mounting without a cleaning step. Since the standoff height of mounted QFN packages is comparatively low, it is difficult to remove flux residues that remain between the QFN package and the mounting board. We recommend that users look into the types of solder paste that do not require cleaning, or consulting with the solder paste and cleaning agent manufacturers.

7. Visual Inspection

With the earlier lead type SMD packages, the solder defects that occurred included solder balls, wicking, solder not connected, and shorting. These defects could be detected with either visual inspection or inspection using some sort of optical system. QFN package soldering defects include solder not connected and shorts. However, since the solder connections are made underneath the package, they cannot be detected with inspection methods that use an optical system. Although shorting defects can be detected with transmission X-ray units, solder not connected defects cannot be detected. There are now three-dimensional detection methods that have been developed for inspection of locations, such as the areas under the packages, that cannot be seen visually. These include tomosynthesis methods and laminography methods that use a scanning X-ray beam. Currently, the equipment listed in the table below is available commercially as equipment for performing post-soldering visual inspections. However, there are products whose operation can be influenced by exposure to X-rays, so adoption of these methods requires careful verification in advance.

Table 7.1 Visual Inspection Equipment

Inspection Method	Details of the Inspection Method
Optical systems	<ul style="list-style-type: none"> • Integrated laser/sensor rotating scan method • Color highlight method • Combined laser and multi-camera method • Laser scanning method
X-ray methods	<ul style="list-style-type: none"> • Methods in which X-ray transmission images are converted to 3D data showing the object's actual shape • Methods in which X-ray slice images are converted to 3D data showing the object's actual shape

7.1 Overview of the QFN Package Pin End Surface

Since, like the QFP and other packages, the QFN pin end surface is created by cutting processing performed after pin plating, QFN packages have a structure in which the pin material, without plating, is exposed. In particular, in dicing cut type QFN packages, since there is no flow-around of plating material, the exposed surface of the pin material (Cu) is large. The following shows the results of studying the wettability of these pin ends.

	Punching Cut Type	Dicing Cut Type	
	Pin End Surface	Pin End Surface	Package Back Surface
Pin End Visual Appearance			
Features of the Machining	As is the case with QFP and similar packages, the pin ends are cut by punching (with a die). The pin end surface (pin material) is exposed and some of the plating material flows around the edges. These, however, are not subject to this management.	Dicing cut is performed by cutting with a dicer (a rotating blade). The pin end surface (pin material) is exposed.	

Figure 7.1 QFN Pin End Surface Overview

7.2 Visual Comparison of Air Reflow and Nitrogen Reflow Mounting

The table below shows the results of evaluating the effects and influence of the reflow atmosphere. This shows that a nitrogen atmosphere can be more effective than air for reflow soldering and also that we can see an effect on pin end surface wetting by soldering the die pad. We recommend die pad soldering, which has an effect on pin end wetting, and nitrogen atmosphere reflow soldering.

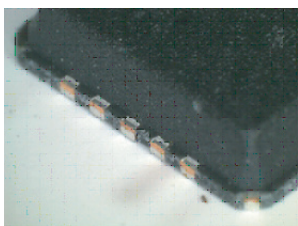
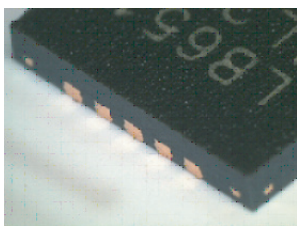
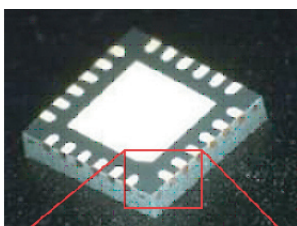
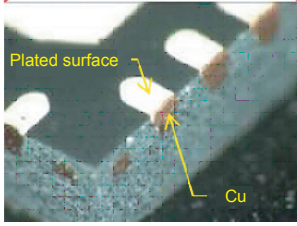

Preprocessing	None	30°C / 70% RH 168h	
	Die Pad	No Connection	No Connection
Air Reflow			
Nitrogen Reflow			

Figure 7.2 Comparison of Effects and Influence of the Reflow Atmosphere

8. On Board Mechanical Stress Test Results

After mounting, solder may be peeled away by mechanical shock. The user should design products and manufacturing processes based on thorough verification of stresses applied during manufacturing, such as when cutting boards apart, the possibility of accidentally dropping boards, and the environment in which the product will be handled in the market.

Since they don't have leads, QFN packages mounted on a printed wiring board cannot follow bending of the wiring board, and we have identified cases when, due to their not being able to follow the wiring board, the packages crack when extremely large bending is applied to the wiring board. We recommend that users look into board mounting layouts that avoid mounting in sections to which large bending forces may be applied.

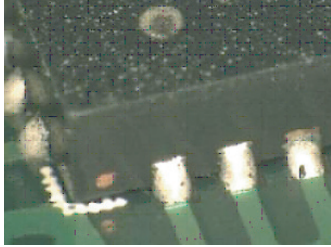
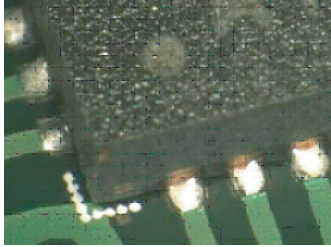
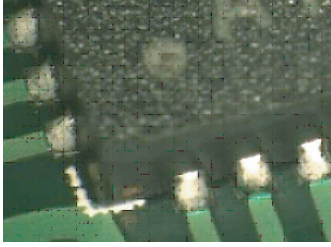
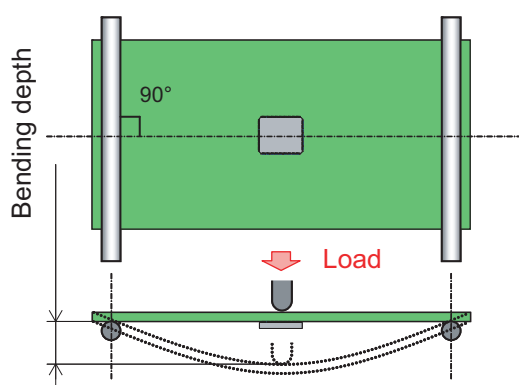

Evaluation method of maximum bending:
Load from back side center of board.
To measure depth when package crack occurred.

Figure 8.1 Evaluation Method of Maximum Bending

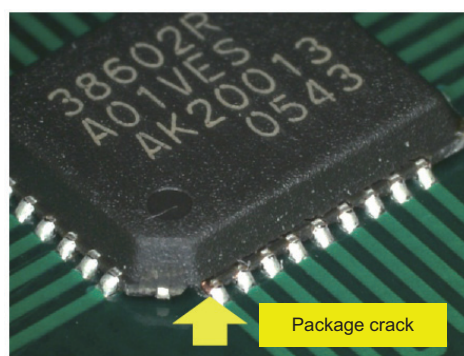

Figure 8.2 Package Crack

Table 8.1 The Evaluation Results of Maximum Bending (Reference)

	Measurement Span for Bending	Max Bending Depth	Bending Load
90 mm	<p>JEITA stipulated span 90 mm</p>	17.18 mm	3.23 kg
60 mm	<p>60 mm</p>	8.81 mm	6.60 kg
30 mm	<p>30 mm</p>	2.08 mm	13.72 kg

9. On Board Reliability Test Results

9.1 Board Mounted Thermal Cycle Test Results (punching cut type, 6 × 6 mm, 0.4 mm pitch)

The results of an evaluation of the effects of whether or not die pad soldering was used are shown below. This testing showed that die pad soldering has an effect on solder connection reliability.

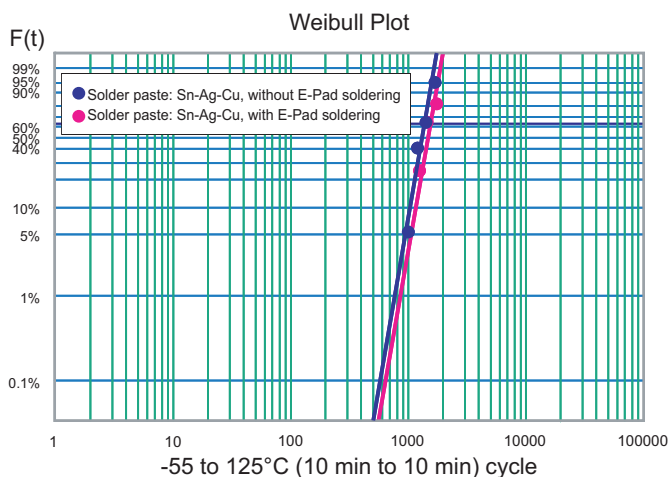

Figure 9.1 Weibull Plot
(Evaluation results of temp. cycle on board)

Table 9.1 Evaluation Specs

Test temperature	-55 to 125°C: 10 minutes dwell
Package	<ul style="list-style-type: none"> • P-VQFN48-6x6-0.4 • Lead material: Cu • Lead plating: Sn-Bi
Printed wiring board	<ul style="list-style-type: none"> • Size: 50 × 100 × t0.8 mm • Material: FR-4/4 layers • Pad surface processing: Cu + OSP
Stencil	Thickness: 0.10 mm (die pad aperture: 1.6 mm square × 4)
Reflow soldering temperature (leads)	Sn-3Ag-0.5Cu paste: 245°C max
Failure definition	Failure recognized when not conducting

9.2 Board Mounted Thermal Cycle Test Results (dicing cut type, 5 × 5 mm, 0.5 mm pitch)

The results of an evaluation of the effects of whether or not die pad soldering was used are shown below. This testing showed that die pad soldering has an effect on solder connection reliability.

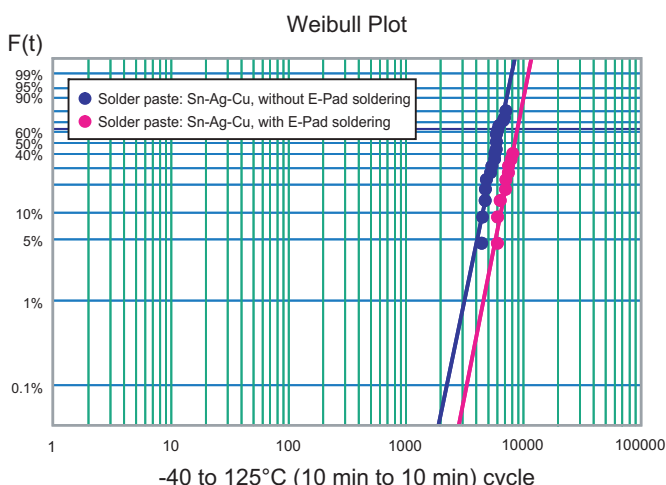

Figure 9.2 Weibull Plot
(Evaluation results of temp. cycle on board)

Table 9.2 Evaluation Specs

Test temperature	-40 to 125°C: 10 minutes dwell
Package	<ul style="list-style-type: none"> • P-WQFN32-5x5-0.5 • Lead material: Cu • Lead plating: Ni/Pd/Au
Printed wiring board	<ul style="list-style-type: none"> • Size: 124 × 130 × t0.8 mm • Material: FR-4/4 layers • Pad surface processing: Cu + OSP
Stencil	Thickness: 0.12 mm (die pad aperture: 1.25 mm square × 4)
Reflow soldering temperature (leads)	Sn-3Ag-0.5Cu paste: 240°C max
Failure definition	20% nominal resistance increase

9.3 Board Mounted Thermal Cycle Test Results (dicing cut type, 7 × 7 mm, 0.5 mm pitch)

The results of an evaluation of the effects of whether or not die pad soldering was used are shown below. This testing showed almost no effect of die pad soldering on solder connection reliability.

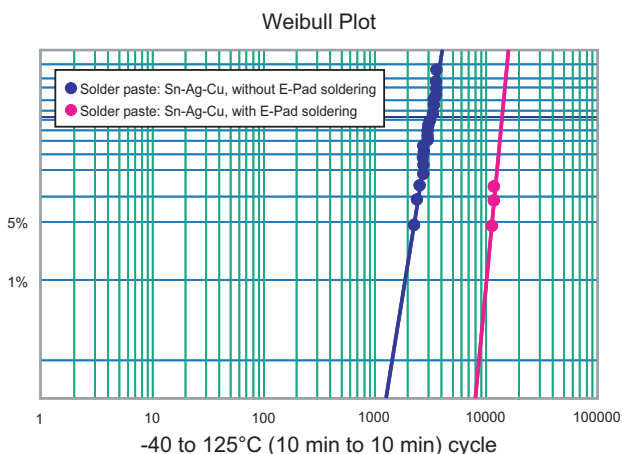

Figure 9.3 Weibull Plot
(Evaluation results of temp. cycle on board)

Table 9.3 Evaluation Specs

Test temperature	-40 to 125°C: 10 minutes dwell
Package	<ul style="list-style-type: none"> • P-WQFN48-7x7-0.5 • Lead material: Cu • Lead plating: Ni/Pd/Au
Printed wiring board	<ul style="list-style-type: none"> • Size: 124 × 130 × t0.8 mm • Material: FR-4/4 layers • Pad surface processing: Cu + OSP
Stencil	Thickness: 0.12 mm (die pad aperture: 1.38 mm square × 9)
Reflow soldering temperature (leads)	Sn-3Ag-0.5Cu paste: 240°C max
Failure definition	20% nominal resistance increase

9.4 Board Mounted Thermal Cycle Test Results (dicing cut type: package shape dependency)

This testing showed that the smaller the package the greater the effect on connection lifetime.

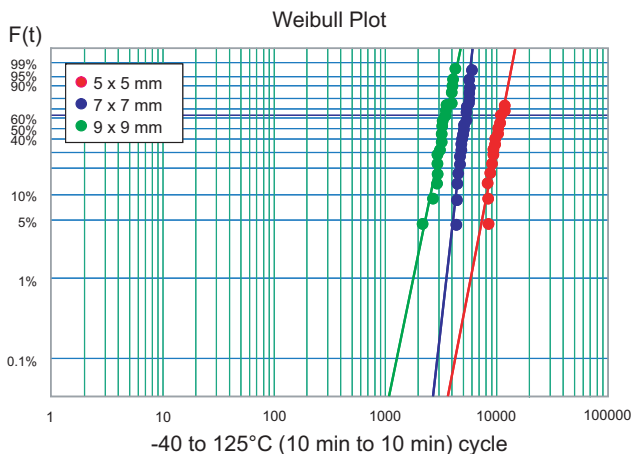

Figure 9.4 Weibull Plot
(Evaluation results of temp. cycle on board)

Table 9.4 Evaluation Specs

Test temperature	-40 to 125°C: 10 minutes dwell
Package	<ul style="list-style-type: none"> • 5 × 5 mm, 32 pins, 0.5 mm pitch • 7 × 7 mm, 48 pins, 0.5 mm pitch • 9 × 9 mm, 64 pins, 0.5 mm pitch • Cu + Ni/Pd/Au plating
Printed wiring board	<ul style="list-style-type: none"> • Size: 124 × 130 × t1.6 mm • Material: FR-4/4 layers • Pad surface processing: Cu + OSP
Stencil	Thickness: 0.12 mm
Reflow soldering temperature (leads)	Sn-3Ag-0.5Cu paste: 240°C max
Failure definition	20% nominal resistance increase

10. QFN Reworking (removal from the mounting board)

Although it is not possible to repair boards with a soldering iron after QFN package devices have been mounted, it is possible using special-purpose equipment. The following points must be observed in the reworking method used.

- The influence of the heating on adjacent pins must be minimized.
- Since the heating conditions will differ due to differences in the heat capacities of the printed wiring board (board thickness, number of layers) and mounted components used. Therefore the conditions must be set to correspond to the actual product and its mounted components.
- Consult the manufacturer of each component to determine if mounted components can be reused after reworking.

Note: Renesas quality guarantees do not apply to components that have been removed during package reworking (component replacement). Therefore we strongly recommend that component reuse be avoided if at all possible.

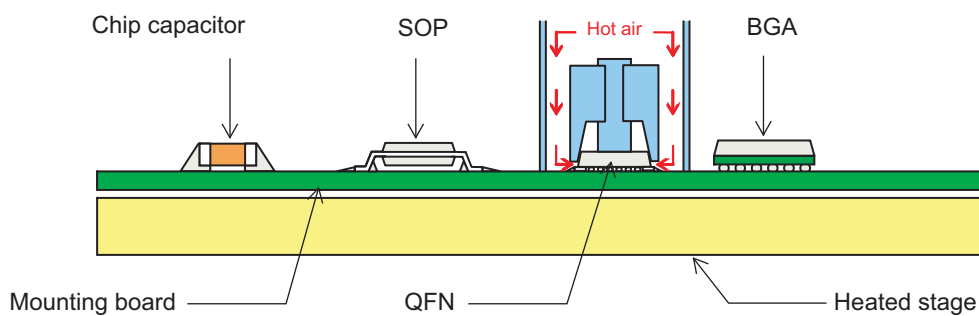

Figure 10.1 QFN Reworking Method

QFN Mounting Manual

Publication Date: Rev.1.00 Sep 26, 2013
Rev.1.50 Mar 25, 2015

Published by: Renesas Electronics Corporation

**SALES OFFICES****Renesas Electronics Corporation**<http://www.renesas.com>Refer to "<http://www.renesas.com/>" for the latest and detailed information.**Renesas Electronics America Inc.**2801 Scott Boulevard Santa Clara, CA 95050-2549, U.S.A.
Tel: +1-408-588-6000, Fax: +1-408-588-6130**Renesas Electronics Canada Limited**9251 Yonge Street, Suite 8309 Richmond Hill, Ontario Canada L4C 9T3
Tel: +1-905-237-2004**Renesas Electronics Europe Limited**Dukes Meadow, Millboard Road, Bourne End, Buckinghamshire, SL8 5FH, U.K.
Tel: +44-1628-585-100, Fax: +44-1628-585-900**Renesas Electronics Europe GmbH**Arcadiastrasse 10, 40472 Düsseldorf, Germany
Tel: +49-211-6503-0, Fax: +49-211-6503-1327**Renesas Electronics (China) Co., Ltd.**Room 1709, Quantum Plaza, No.27 ZhiChunLu Haidian District, Beijing 100191, P.R.China
Tel: +86-10-8235-1155, Fax: +86-10-8235-7679**Renesas Electronics (Shanghai) Co., Ltd.**Unit 301, Tower A, Central Towers, 555 Langao Road, Putuo District, Shanghai, P. R. China 200333
Tel: +86-21-2226-0888, Fax: +86-21-2226-0999**Renesas Electronics Hong Kong Limited**Unit 1601-1611, 16/F., Tower 2, Grand Century Place, 193 Prince Edward Road West, Mongkok, Kowloon, Hong Kong
Tel: +852-2265-6688, Fax: +852 2886-9022**Renesas Electronics Taiwan Co., Ltd.**13F, No. 363, Fu Shing North Road, Taipei 10543, Taiwan
Tel: +886-2-8175-9600, Fax: +886 2-8175-9670**Renesas Electronics Singapore Pte. Ltd.**80 Bendemeer Road, Unit #06-02 Hyflux Innovation Centre, Singapore 339949
Tel: +65-6213-0200, Fax: +65-6213-0300**Renesas Electronics Malaysia Sdn.Bhd.**Unit 1207, Block B, Menara Amcorp, Amcorp Trade Centre, No. 18, Jln Persiaran Barat, 46050 Petaling Jaya, Selangor Darul Ehsan, Malaysia
Tel: +60-3-7955-9390, Fax: +60-3-7955-9510**Renesas Electronics India Pvt. Ltd.**No.777C, 100 Feet Road, HAL II Stage, Indiranagar, Bangalore, India
Tel: +91-80-67208700, Fax: +91-80-67208777**Renesas Electronics Korea Co., Ltd.**12F., 234 Teheran-ro, Gangnam-Gu, Seoul, 135-080, Korea
Tel: +82-2-558-3737, Fax: +82-2-558-5141

QFN Mounting Manual



Renesas Electronics Corporation

R50ZZ0005EJ0150

QFN Mounting Manual