

Power Profiler Kit II

v1.0.1

User Guide

Contents

Revision history	iv
1 Introduction	5
2 Minimum requirements	6
3 Kit content	7
3.1 Hardware content	7
3.2 Downloadable content	7
4 Quick start	8
5 Hardware description	9
5.1 Measurement system	9
5.1.1 Block diagram	9
5.1.2 Power supply	9
5.1.3 EEPROM	10
5.2 Connectors	10
6 Setting up the PPK2	11
6.1 Preparing a DK for current measurement	11
6.2 Measuring current in Source Meter mode	11
6.3 Measuring current in Ampere Meter mode	11
6.4 Logic port	12
6.5 Connecting the PPK2 to a computer	12
6.6 Installing the Power Profiler app	12
7 Using the Power Profiler app	14
7.1 Digital channels	14
7.2 Advanced controls	15
7.2.1 Gains	15
7.2.2 Spike filter	15
8 Electrical specifications	16
8.1 Environmental specifications	16
8.2 Power supply specifications	16
8.3 Measurement specifications	17
8.3.1 Maximum DUT admissible current	17
8.3.2 Measurement resolution	17
8.3.3 Measurement accuracy	17
8.3.4 Digital input resolution	18
9 Troubleshooting	19
Glossary	20
Acronyms and abbreviations	21

Recommended reading.	22
Legal notices.	23

Revision history

Date	Description
2020-12-01	First release

1 Introduction

The Power Profiler Kit II (PPK2) is an affordable, flexible tool that measures the real-time power consumption of your designs.

The PPK2 measures power consumption by either providing power to the external board or acting as an amper meter. It measures current from 500 nA to 1 A and gives a detailed picture of the current profile for the user application.

The PPK2 can measure current on any external board (e.g. nRF5 Series or nRF91 Series DKs). The hardware is delivered with an application that is installed using [nRF Connect for Desktop](#). There are several measurement configurations, which are described in this user guide.

Key features

- Variable power supply voltage ranging from 0.8 V to 5.0 V (software configurable)
- Maximum 1 A current measurement
- Accurate measurement down to approximately 200 nA
- Resolution down to 0.2 μ A
- 100 kS/s sampling speed
- Automatic switching between five current measurement ranges ensuring optimal resolution
- Measurement accuracy better than ± 20 % (average currents measurement)
- 8 pin digital port for digital tracing
- USB communication, enabling simple porting to other applications
- Desktop application for measurement analysis
- Real-time current measurement display

Applications

- Quick power consumption measurements on a firmware running on any nRF *Development Kit (DK)*
- Accumulative measurements, such as average, maximum, and charge
- Instantaneous measurements presented as waveform plots

The PPK2 is manufactured by Nordic Semiconductor ASA, Otto Nielsens veg 12, 7052 Trondheim, Norway.

Note: If the PPK2 is used in a manner not specified by Nordic Semiconductor, the protection provided by the equipment may be impaired.



Environmental Protection

Waste electrical products should not be disposed of with household waste.

Please recycle where facilities exist. Check with your local authority or retailer for recycling advice.

2 Minimum requirements

Before you start setting up the PPK2, check that you have the required hardware and software.

Hardware requirements

- USB cable

Software requirements

- One of the following operating systems:
 - Microsoft Windows 8 or 10
 - macOS
 - Linux
- [nRF Connect for Desktop](#)

3 Kit content

The PPK2 consists of hardware and access to software components, reference design files, and documentation.

3.1 Hardware content

The PPK2 hardware content consists of the PPK2 board, 4-pin current measurement cable, and 10-pin logic port cable.

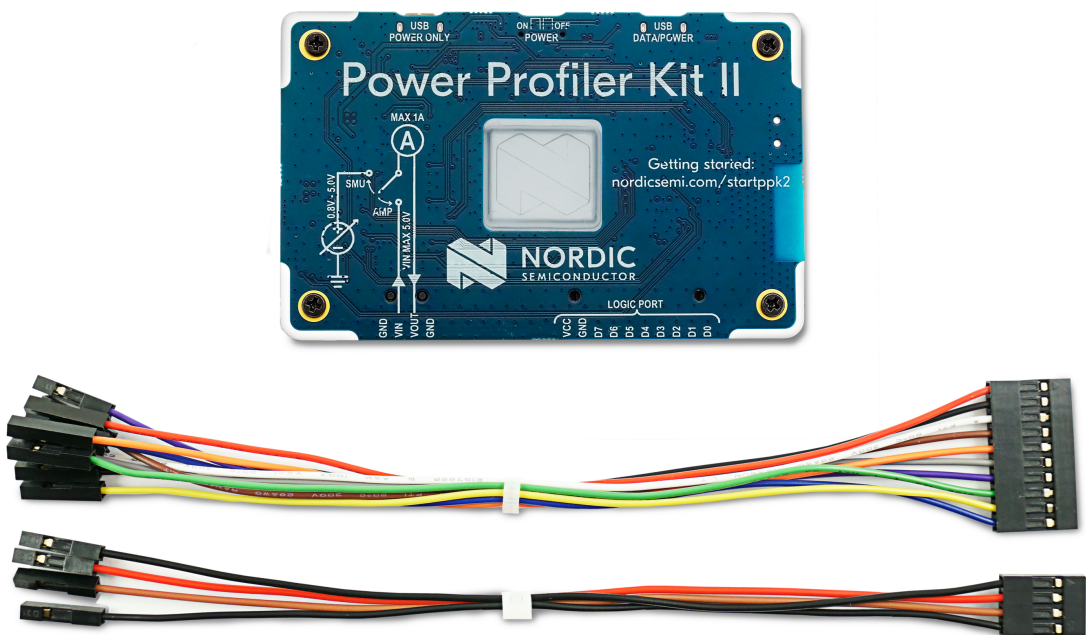

Figure 1: PPK2 board and cables

3.2 Downloadable content

The downloadable content for PPK2 consists of hardware files and this user guide.

You can download the hardware files from the [Power Profiler Kit II](#) product page.

The hardware zip file contains the following files:

- Altium Designer files
- Production files (bill of materials and assembly, drill, Gerber, and pick-and-place files)
- PCB layout files and schematics in PDF format

You also need [nRF Connect for Desktop](#).

4 Quick start

In this quick start, the PPK2 measures current on the nRF9160 DK.

1. Prepare the nRF9160 DK for current measurements by doing some modifications to the *DK*. See the [nRF9160 DK User Guide](#) for instructions on how to do this.

Note: If you are using a different *DK*, see [Preparing a DK for current measurement](#) on page 11 for more information.

2. Connect the PPK2 to the *DK* with a 4-pin measurement cable using the following pins:
 - PPK2 **VIN** to **P22 VDD_nRF**
 - PPK2 **VOUT** to **P22 VDD_nRF**
 - PPK2 **GND** to **P21 GND**
3. Connect the *DK* to a computer using a USB cable.

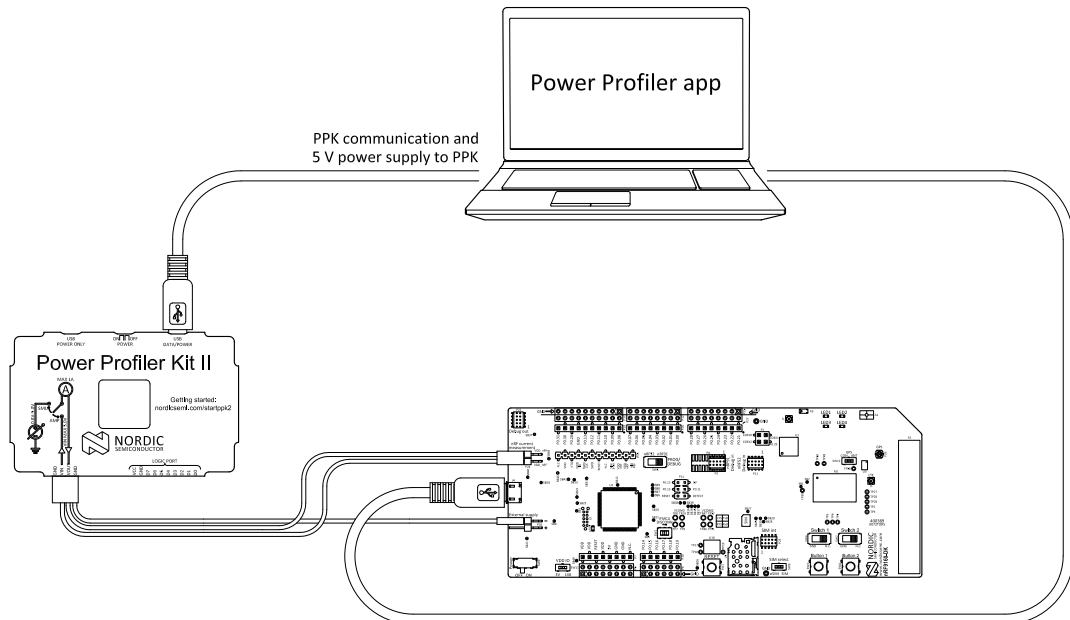

Figure 2: Typical configuration for measuring current on the DK

4. Install the Power Profiler app from nRFConnect for Desktop as described in [Installing the Power Profiler app](#) on page 12.
5. Start the Power Profiler app as described in [Using the Power Profiler app](#) on page 14.
6. Select **Ampere meter** as the mode.

The PPK2 is now ready to use.

5 Hardware description

The PPK2 contains connectors and measurement components.

5.1 Measurement system

The PPK2 is driven by the nRF52840 *System on Chip (SoC)*, which uses its analog-to-digital converter (ADC) to measure a voltage drop over a series of measurement resistors. Resistor values are used to calculate the power consumption. The PPK2 has five different measurement ranges, which are managed by an automatic switch circuitry.

To send the data to the desktop application, the nRF52840 *SoC* uses USB Communication Device Class (CDC) Abstract Control Model (ACM) which all major operating systems support without the need for extra driver installations.

5.1.1 Block diagram

The PPK2 block diagram illustrates the overall system and connections between the various blocks.

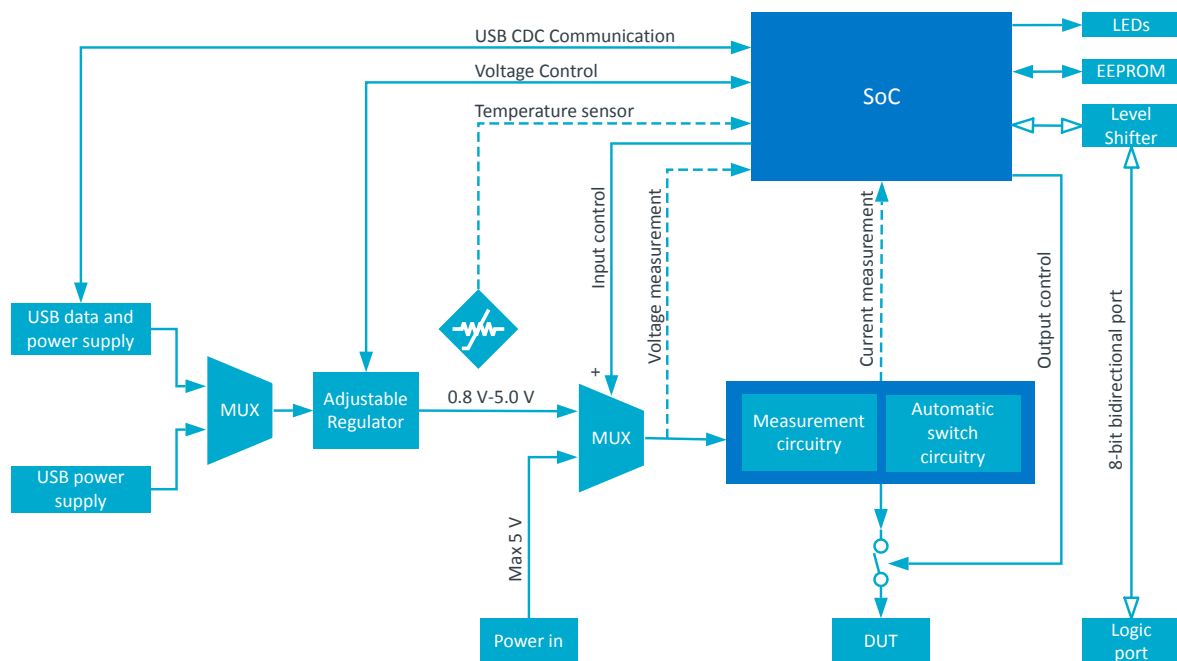

Figure 3: Block diagram

5.1.2 Power supply

There are two different modes of measurement for the PPK2.

The measurement modes are:

- Source Meter
- Ampere Meter

The modes are selected in the Power Profiler app.

When the PPK2 is used in Source Meter mode, its output can be adjusted between 0.8 - 5.0 V through the Power Profiler app.

When the PPK2 is used in Ampere Meter mode, an external power supply is used for the *Device Under Test (DUT)*. The external voltage is applied directly to the circuits without regulation. This voltage must be limited to the 0.8 - 5.0 V range.

The data/power USB connection must always be connected when using the PPK2. If the PPK2 is operating in Source Meter mode and the *DUT* can draw more than 400 mA, an extra external USB power supply that can deliver 1 A or more is recommended.

5.1.3 EEPROM

On the PPK2, there is an EEPROM memory connected to the nRF52840 SoC. The EEPROM is used to store calibration data.

5.2 Connectors

Access to the PPK2 is available from a set of connectors.

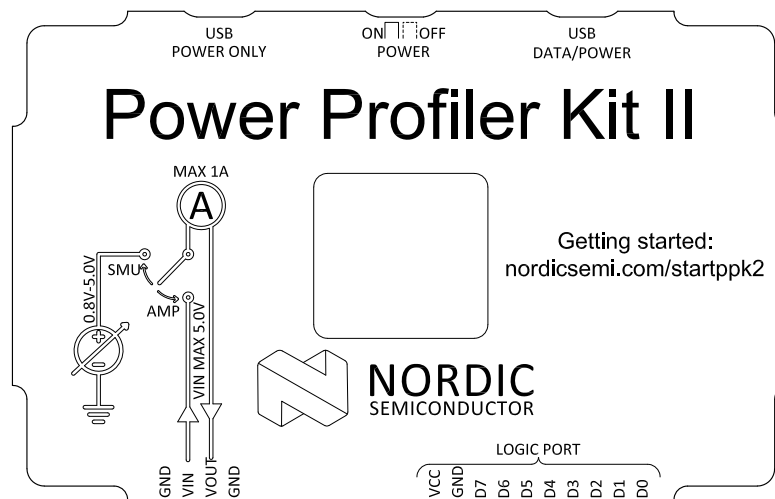

Figure 4: PPK2 connectors

Connector	Description
GND	Ground connection to <i>DUT</i> .
VOUT	Positive voltage output to <i>DUT</i> .
VIN	External power input. Only used for Ampere meter mode.
GND	Ground connection to <i>DUT</i> .
USB DATA/POWER	USB connection for power and communication with the PPK2.
USB POWER ONLY	USB connection for supplying extra power to the PPK2. Only needed in Source Meter mode (> 400 mA).
LOGIC PORT	
VCC	VCC of <i>DUT</i>
GND	GND of <i>DUT</i>
D0–D7	Digital input pins

Table 1: PPK2 connectors

6 Setting up the PPK2

The following sections help you set up the PPK2.

6.1 Preparing a DK for current measurement

When measuring current with the PPK2, some adjustments are needed to measure current on the *DK*.

See the following links for more information on your relevant *DK*:

- [Preparing the development kit board](#) in the [nRF51 DK User Guide](#)
- [Preparing the nRF52 DK](#)
- [Preparing the nRF52840 DK](#)
- [Preparing the nRF52833 DK](#)
- [Preparing the nRF9160 DK](#)
- [Preparing the nRF5340 PDK](#)

6.2 Measuring current in Source Meter mode

When the PPK2 is used in Source Meter mode, the *DUT* is supplied power by the PPK2.

The voltage output to the *DUT* is adjusted with the Power Profiler app (see [Using the Power Profiler app](#) on page 14).

The following figure shows a typical measurement configuration using the nRF9160 DK.

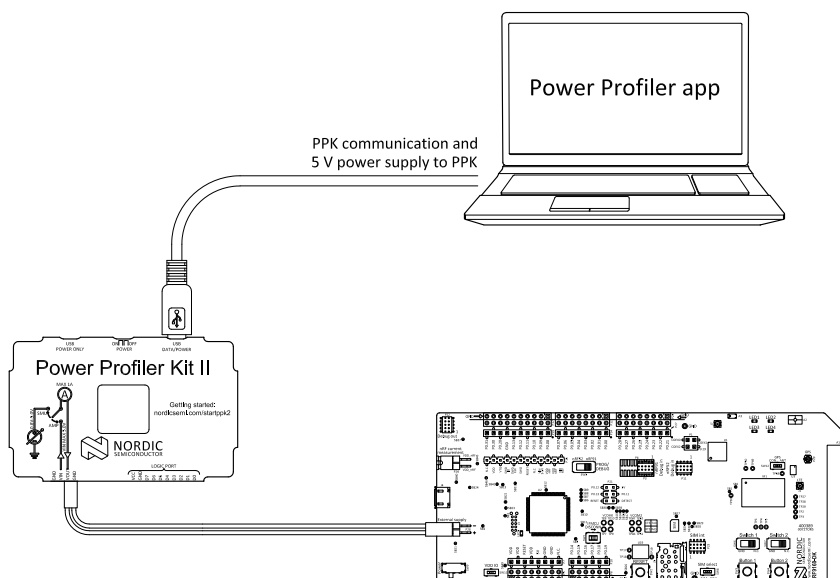

Figure 5: Measuring current in Source Meter mode

6.3 Measuring current in Ampere Meter mode

When the PPK2 is used in Ampere Meter mode, the *DUT* must be supplied power from an external source (e.g. USB).

The following figure shows a typical measurement configuration using the nRF9160 DK.

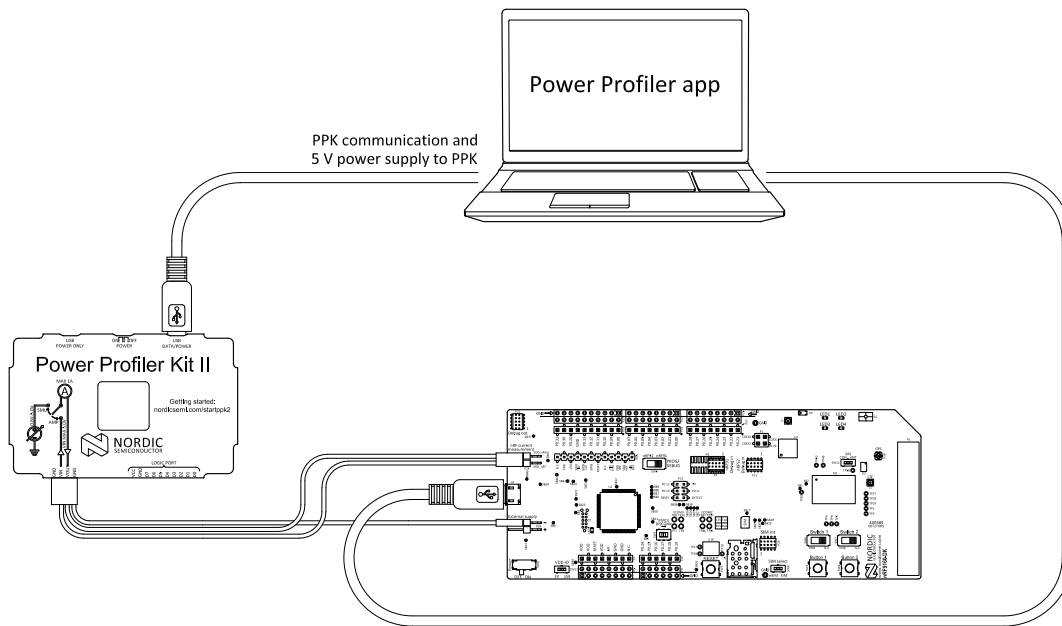

Figure 6: Measuring current in Ampere Meter mode

When you have connected the PPK2 to the *DUT* with your preferred mode, see [Connecting the PPK2 to a computer](#) on page 12.

6.4 Logic port

The PPK2 supports reading digital inputs on up to 8 channels simultaneously.

To use the logic port, connect the following:

- *DUT*'s VCC to the PPK2 logic port VCC pin
- *DUT*'s GND to the PPK2 logic port GND pin
- *DUT*'s digital signal to any logic port Dx pin

6.5 Connecting the PPK2 to a computer

Connect the PPK2 to your computer using a USB cable.

Once connected, you can start the Power Profiler app.

Note: In Source Meter mode, the USB power source has to support the maximum current consumption for the *DUT*, in addition to approximately 50 mA for the PPK2 circuitry.

6.6 Installing the Power Profiler app

The Power Profiler app is installed as an app for nRF Connect for Desktop.

Before you can install the Power Profiler app, you must download and install [nRF Connect for Desktop](#).

To install the Power Profiler app:

1. Open **nRF Connect for Desktop**.
2. Find **Power Profiler** in the list of apps and click **Install**.

Once the app is installed, you can launch it by clicking **Open**.

For easy access, you can create a desktop shortcut by clicking the **arrow down** button and selecting **Create shortcut**.

If a new version of the app becomes available, an **Update** button is displayed next to the **Open** button. Click this button to install the latest version. To uninstall the app, click the **arrow down** button and select **Uninstall**.

7 Using the Power Profiler app

The PPK2 must be connected to your computer and powered on before the Power Profiler app is started.

1. Open the Power Profiler app using nRF Connect.

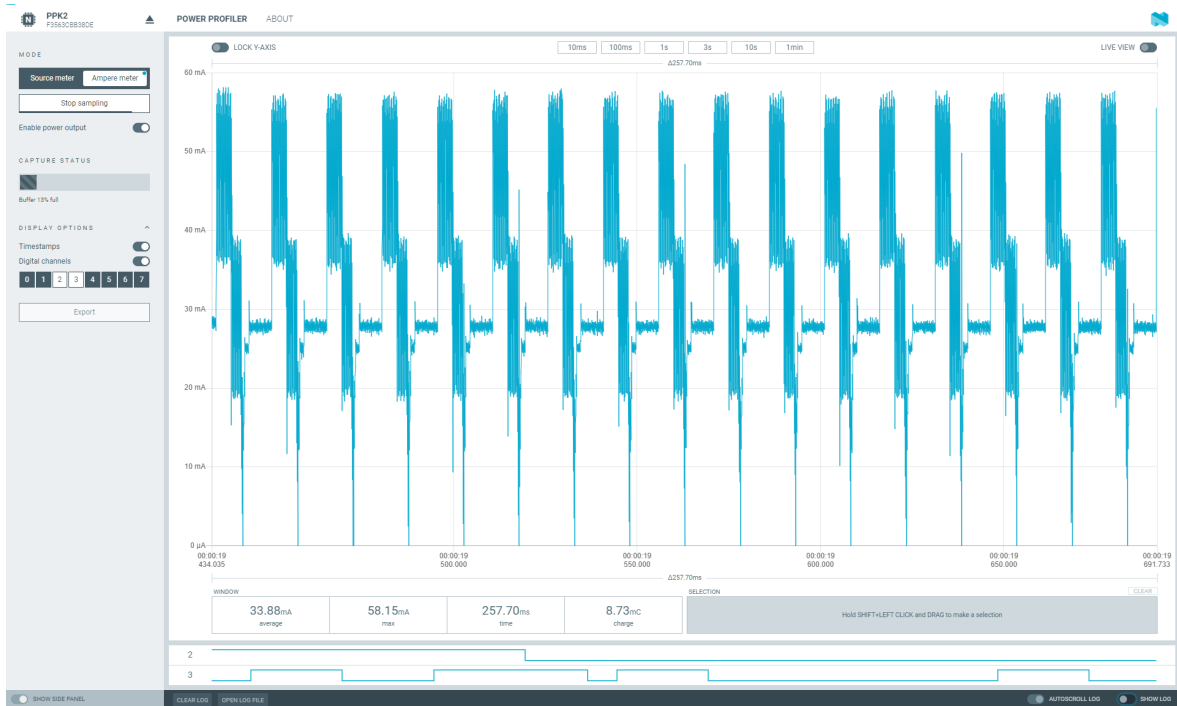

Figure 7: Settings and Plots view in the Power Profiler app

2. Click **Select Device** (in the top left corner) and select the PPK2 from the list.
3. Do one of the following:
 - If the PPK2 is set up to measure in Ampere Meter mode (see [Figure 6: Measuring current in Ampere Meter mode](#) on page 12), select **Ampere Meter**.
 - If the PPK2 is set up to measure in Source Meter mode (see [Figure 5: Measuring current in Source Meter mode](#) on page 11), select **Source Meter**.

Note: You can change the voltage output to the *DUT* by expanding **Voltage Adjustment** and selecting the required voltage.

4. Click **Start sampling**.
5. Toggle **Enable power output** to enable power to the *DUT*.

You can start measuring current when connection is established.

The application will check if the required firmware is present in the PPK2 and show a firmware upgrade dialog if needed.

7.1 Digital channels

The digital signals are visible in the charting section below the current measurement.

The digital signals are connected to the PPK2's Logic port as described in [Logic port](#) on page 12. To view the digital values, enable digital channels and zoom in on the main chart until the values are visible.

7.2 Advanced controls

The advanced control panel gives you access to filter tuning and lets you adjust gains for all individual ranges.

Press **CTRL+ALT+SHIFT+A** to access the advanced control panel.

Note: The settings should only be adjusted by advanced users.

7.2.1 Gains

If any of the ranges (see [Table 6: Measurement resolution](#) on page 17) has an offset, use these controls to add a positive or negative gain to the calculated measurement values.

7.2.2 Spike filter

Whenever a dynamic range switching occurs, induced inductance may cause the first samples to be higher than the actual value.

Use the sliders to set the following:

- **Samples to smooth** - The number of samples after a dynamic range switch to apply the filter.
- **Coefficient for range 1–4** - The magnitude of the spike filter for range 1–4. The higher the value, the more filtering will be applied.
- **Coefficient for range 5** - The magnitude of the spike filter for range 5. The higher the value, the more filtering will be applied.

8 Electrical specifications

These specifications contain the property values that are essential for using the PPK2.

8.1 Environmental specifications

These environmental specifications and conditions contain the values that are essential for using the PPK2.

Item	Name	Min	Typ	Max	Unit	Description
Operating temperature	Op_Temp	5		40	°C	

Table 2: Environmental specifications

Item	Description
Indoor or outdoor use	Indoor use
Altitude	Up to 2000 m
Temperature	5–40 °C
Relative humidity	Maximum relative humidity 80% for temperatures up to 31 °C decreasing linearly to 50% relative humidity at 40 °C
Mains supply voltage fluctuations	Not applicable (equipment not connected to mains)
Overvoltage category	Category 0 based on EN 61010-1-2-030
Wet location	Not applicable
Pollution degree	2

Table 3: Normal environmental conditions

Note: Do not use the PPK2 for measurements within Measurement categories II, III, or IV, or for measurements on MAINS circuits or on circuits derived from Overvoltage Category II, III, or IV which may have transient voltages where they can cause a hazard. An analysis of the working voltages, loop impedances, temporary overvoltages, and transient overvoltages in the system must be conducted to making measurements.

8.2 Power supply specifications

These power supply values are essential for using the PPK2.

Item	Name	Min	Typ	Max	Unit	Description
DUT voltage	VDD_DUT	0.8		5.0	V	
External supply voltage	VDD_EXT	0.8		5.0	V	
Micro-USB supply voltage	V5V	4.5		5.5	V	USB voltage tolerances
Logic port VCC	VCC	1.65		5.5	V	
Rated Power				5	W	

Table 4: Power supply specifications

8.3 Measurement specifications

These measurement specifications contain the property values that are essential for using the PPK2.

8.3.1 Maximum DUT admissible current

The maximum *DUT* admissible current specification contains values essential for using the PPK2.

Item	Name	Min	Typ	Max	Unit	Description
Maximum DUT admissible current	Max_I			1	A	Ampere meter mode (continuous)
				600	mA	Source Meter mode

Table 5: Maximum DUT admissible current

8.3.2 Measurement resolution

These measurement resolution values are essential for using the PPK2.

Range	Name	Typ	Unit
200 nA–50 μ A	R1_Resol	0.2	μ A
50 μ A–500 μ A	R2_Resol	0.5	μ A
500 μ A–5 mA	R3_Resol	5	μ A
5 mA–50 mA	R4_Resol	50	μ A
50 mA–1000 mA	R5_Resol	1000	μ A

Table 6: Measurement resolution

8.3.3 Measurement accuracy

These measurement accuracy values are essential for using the PPK2.

Name	Range	Typ	Description
R1_Accuracy	100 nA–50 μ A	$\pm 10\%$	Readout on average value
R1_Offset		$\pm 2\%$	
R2_Accuracy	50 μ A–500 μ A	$\pm 10\%$	Readout on average value
R2_Offset		$\pm 2\%$	
R3_Accuracy	500 μ A–5 mA	$\pm 10\%$	Readout on average value
R3_Offset		$\pm 2\%$	
R4_Accuracy	5 mA–50 mA	$\pm 10\%$	Readout on average value
R4_Offset		$\pm 2\%$	
R5_Accuracy	50 mA–1000 mA	$\pm 15\%$	Readout on average value
R5_Offset		$\pm 5\%$	

Table 7: Measurement accuracy

8.3.4 Digital input resolution

Digital input pins **D0–D7** are sampled with 100 kHz frequency with a typical bandwidth of 50 kHz.

9 Troubleshooting

Here are some basic troubleshooting steps to help you fix issues you may encounter when using the PPK2.

PPK2 only measuring noise

Make sure you have connected the PPK2 to the *DUT* as described in [Setting up the PPK2](#) on page 11.

Measurements fluctuate when there should be a steady current draw

Your *DUT* may have a power consumption that is close to a switching point causing rapid switching between the ranges and creating measurement errors/distorted plots.

Graph response is very slow

Avoid using USB hubs and docking stations. Data plotting may consume a lot of CPU resources after some time, so ensure that sufficient resources are available.

PPK2 not measuring anything

Confirm that the measurement cables are connected correctly because the PPK2 cannot measure negative currents.

Grounding

Ensure that the *DUT* ground is connected to the PPK2 even in ampere meter mode.

For more information, visit [Nordic DevZone](#).

For personalized support from our technical support team, sign up for or sign in to [Nordic Developer Zone](#) and enter a private ticket.

Glossary

Development Kit (DK)

A development platform used for application development.

Device Under Test (DUT)

A manufactured product undergoing testing.

System on Chip (SoC)

A microchip that integrates all the necessary electronic circuits and components of a computer or other electronic systems on a single integrated circuit.

Acronyms and abbreviations

These acronyms and abbreviations are used in this document.

DK

Development Kit

DUT

Device Under Test

SoC

System on Chip

Recommended reading

In addition to the information in this document, you may need to consult other documents.

Nordic documentation

- [nRF51 DK](#)
- [nRF52 DK](#)
- [nRF52833 DK](#)
- [nRF52840 DK](#)
- [nRF9160 DK Hardware](#)
- [nRF5340 PDK](#)

Legal notices

By using this documentation you agree to our terms and conditions of use. Nordic Semiconductor may change these terms and conditions at any time without notice.

Liability disclaimer

Nordic Semiconductor ASA reserves the right to make changes without further notice to the product to improve reliability, function, or design. Nordic Semiconductor ASA does not assume any liability arising out of the application or use of any product or circuits described herein.

Nordic Semiconductor ASA does not give any representations or warranties, expressed or implied, as to the accuracy or completeness of such information and shall have no liability for the consequences of use of such information. If there are any discrepancies, ambiguities or conflicts in Nordic Semiconductor's documentation, the Product Specification prevails.

Nordic Semiconductor ASA reserves the right to make corrections, enhancements, and other changes to this document without notice.

Life support applications

Nordic Semiconductor products are not designed for use in life support appliances, devices, or systems where malfunction of these products can reasonably be expected to result in personal injury.

Nordic Semiconductor ASA customers using or selling these products for use in such applications do so at their own risk and agree to fully indemnify Nordic Semiconductor ASA for any damages resulting from such improper use or sale.

RoHS and REACH statement

Complete hazardous substance reports, material composition reports and latest version of Nordic's REACH statement can be found on our website www.nordicsemi.com.

Trademarks

All trademarks, service marks, trade names, product names, and logos appearing in this documentation are the property of their respective owners.

Copyright notice

© 2020 Nordic Semiconductor ASA. All rights are reserved. Reproduction in whole or in part is prohibited without the prior written permission of the copyright holder.

**COMPANY WITH
QUALITY SYSTEM
CERTIFIED BY DNV GL
= ISO 9001 =**