

NEO-M8P

u-blox M8 high precision GNSS modules

Data sheet



Abstract

The NEO-M8P module provides centimeter-level GNSS positioning for the mass market with integrated real time kinematics (RTK) for fast time-to-market. This small, light, and energy-efficient RTK module is a complete and versatile solution thanks to its base and rover variants and moving baseline technology for attitude sensing and follow-me applications.

Document information

Title	NEO-M8P	
Subtitle	u-blox M8 high precision GNSS modules	
Document type	Data sheet	
Document number	UBX-15016656	
Revision and date	R08	9-Mar-2020
Document status	Production Information	

Product status	Corresponding content status	
In development / Prototype	Objective specification	Target values. Revised and supplementary data will be published later.
Engineering sample	Advance information	Data based on early testing. Revised and supplementary data will be published later.
Initial production	Early production information	Data from product verification. Revised and supplementary data may be published later.
Mass production / End of life	Production information	Document contains the final product specification.

This document applies to the following products:

Product name	Type number	ROM/FLASH version	PCN reference
NEO-M8P	NEO-M8P-0-11	FLASH FW3.01 HPG1.40	N/A
NEO-M8P	NEO-M8P-2-11	FLASH FW3.01 HPG1.40	N/A
NEO-M8P	NEO-M8P-0-10	FLASH FW3.01 HPG1.40	PCN UBX-17023320
NEO-M8P	NEO-M8P-2-10	FLASH FW3.01 HPG1.40	PCN UBX-17023320

u-blox or third parties may hold intellectual property rights in the products, names, logos and designs included in this document. Copying, reproduction, modification or disclosure to third parties of this document or any part thereof is only permitted with the express written permission of u-blox.

The information contained herein is provided "as is" and u-blox assumes no liability for its use. No warranty, either express or implied, is given, including but not limited to, with respect to the accuracy, correctness, reliability and fitness for a particular purpose of the information. This document may be revised by u-blox at any time without notice. For the most recent documents, visit www.u-blox.com.

Copyright © u-blox AG.

Contents

Document information	2
Contents	3
1 Functional description	5
1.1 Overview	5
1.2 Product features	5
1.3 Performance.....	6
1.4 Block diagram	7
1.5 GNSS.....	7
1.5.1 GPS	7
1.5.2 BeiDou	7
1.5.3 GLONASS	7
1.6 RTK operation	8
1.6.1 Rover navigation modes	8
1.6.2 Base station mode (NEO-M8P-2)	9
1.6.3 RTCM message requirements	10
1.7 Raw data	11
1.8 Assisted GNSS (A-GNSS).....	11
1.8.1 AssistNow™ Online	11
1.9 Augmentation systems	11
1.9.1 Differential GNSS (DGNSS)	11
1.10 Data logging	12
1.11 Host interface signature	12
1.12 Geofencing.....	13
1.13 TIMEPULSE	13
1.14 Protocols and interfaces	13
1.15 Interfaces.....	14
1.15.1 UART	14
1.15.2 USB	14
1.15.3 SPI	14
1.15.4 Display Data Channel (DDC)	14
1.16 EXTINT: External interrupt.....	14
1.17 Clock generation.....	14
1.17.1 Oscillators	14
1.17.2 Real-time clock (RTC)	15
1.18 Power management	15
1.18.1 Power control.....	15
1.19 Antenna.....	15
2 Pin definition	16
2.1 Pin assignment.....	16
2.2 Pin name changes.....	17

3	Configuration management	18
3.1	Interface selection (D_SEL)	18
4	Electrical specification	19
4.1	Absolute maximum rating	19
4.2	Operating conditions	19
4.3	Indicative current requirements	20
4.4	SPI timing diagrams	20
4.4.1	Timing recommendations	21
4.5	DDC timing	21
5	Mechanical specifications	22
6	Reliability tests and approvals	23
6.1	Reliability tests	23
6.2	Approvals	23
7	Product handling and soldering	24
7.1	Packaging	24
7.1.1	Reels	24
7.1.2	Tapes	24
7.2	Shipment, storage and handling	25
7.2.1	Moisture sensitivity levels	25
7.2.2	Reflow soldering	25
7.2.3	ESD handling precautions	25
8	Default messages	26
9	Labeling and ordering information	27
9.1	Product labeling	27
9.2	Explanation of codes	27
9.3	Ordering codes	27
	Appendix	28
A	Glossary	28
	Related documents	29
	Revision history	29
	Contact	30

1 Functional description

1.1 Overview

The NEO-M8P modules combine the high performance u-blox M8 positioning engine with u-blox's Real Time Kinematic (RTK) technology. The NEO-M8P provides centimeter-level GNSS performance designed to meet the needs of unmanned vehicles and other machine control applications requiring accurate guidance.

u-blox's RTK technology introduces the concept of a "rover" (NEO-M8P-0) and a "base" (NEO-M8P-2) on the M8 platform for stunning cm-level accuracy in clear-sky environments. The base module sends corrections via the RTCM protocol to the rover module via a communication link, enabling the rover to output its position relative to the base at centimeter-level accuracies. The NEO-M8P is ideal for applications requiring vehicles to move faster and more accurately, operate more efficiently, and automatically return to base platforms. Such applications include UAV, unmanned vehicles (for example, robotic lawn mowers), and Precision Agriculture guidance.

The NEO-M8P modules enable the system integrator to access u-blox's complete end-to-end RTK solution including the stationary "survey-in" functionality that is designed to reduce the setup time and increase the flexibility of the application. The NEO-M8P includes moving baseline (MB) support, allowing both base and rover to move while computing a centimeter-level accurate position between them. A moving baseline is ideal for UAV applications where the UAV is programmed to follow its owner, or to land on a moving platform. It is also well suited to attitude sensing applications where both base and rover modules are mounted on the same moving platform and the relative position is used to derive attitude information for the vehicle or tool.

NEO-M8P modules are compatible with a wide range of communication technologies (Cellular, Wi-Fi, Bluetooth, UHF) enabling the user to select the communication link best suited to their application. With u-blox's RTK technology, integration and software development efforts can be reduced, ensuring a minimal cost of ownership.

The u-blox M8 modules use GNSS chips qualified according to AEC-Q100, they are manufactured in ISO/TS 16949 certified sites, and they are fully tested on a system level. Qualification tests are performed as stipulated in the ISO16750 standard: "Road vehicles – Environmental conditions and testing for electrical and electronic equipment".

The u-blox AssistNow services supply aiding information, such as ephemeris, almanac and time, reducing the time to first fix significantly. The NEO-M8P operates with the AssistNow Online service which provides current GNSS constellation orbit data to allow a time-to-first-fix in seconds.

1.2 Product features

Model	Category	GNSS				Supply	Interfaces	Features	Grade
	Standard Precision GNSS High Precision GNSS Dead Reckoning Timing	GPS/QZSS GLONASS Galileo BeiDou	Number of concurrent GNSS	2.7 V - 3.6 V	UART USB SPI DDC (I2C-compliant)	Programmable (flash) Data logging Additional SAW Additional LNA RTK rover Moving baseline support Base station with survey-in Timepulse	Standard Professional Automotive		
NEO-M8P-0	•	• • •	2	•	• • • •	• • • • • • •	•		
NEO-M8P-2	•	• • •	2	•	• • • •	• • • • • • •	•		

 Quasi-Zenith Satellite System (QZSS) satellites are tracked and included in raw data output but are not used in navigation or real time kinematics (RTK).

1.3 Performance

Parameter	Specification			
Receiver type	72-channel u-blox M8 engine GPS L1C/A, GLONASS L1OF, BeiDou B1I			
Accuracy of timepulse signal	RMS	30 ns		
	99%	60 ns		
Frequency of timepulse signal	0.25 Hz...10 MHz (configurable)			
Operational limits ¹	Dynamics	≤ 4 g		
	Altitude	50,000 m		
	Velocity	500 m/s		
Velocity accuracy	0.05 m/s			
Dynamic heading accuracy	0.3° ^{2,3}			
		GPS & GLONASS	GPS & BeiDou	GPS
Time-To-First-Fix ³	Cold start	26 s	28 s	29 s
	Hot start	1 s	1 s	1 s
	Aided starts ⁴	2 s	3 s	2 s
Sensitivity ⁵	Tracking & Navigation ⁶	-160 dBm	-160 dBm	-160 dBm
	Reacquisition	-160 dBm	-160 dBm	-160 dBm
	Cold start	-148 dBm	-148 dBm	-148 dBm
	Hot start	-157 dBm	-157 dBm	-157 dBm
Max navigation update rate	RTK	5 Hz	5 Hz	8 Hz
	Moving Baseline RTK	4 Hz	4 Hz	4 Hz
	PVT	5 Hz	5 Hz	10 Hz
	RAW	10 Hz	10 Hz	10 Hz
Convergence time ⁷	RTK	<60 s ⁸	<60 s ⁹	3.5 min ⁹
Horizontal position accuracy	Standalone ⁹	2.5 m CEP		
	RTK ^{6,10}	0.025 m + 1 ppm CEP		

Table 1: NEO-M8P performance in different GNSS modes (default: concurrent reception of GPS and GLONASS)

¹ Assuming Airborne < 4 g platform

² 50% at 30 m/s for dynamic operation or assuming a 1 m baseline in MB mode

³ All satellites at -130 dBm

⁴ Dependent on aiding data connection speed and latency

⁵ Demonstrated with a good external LNA

⁶ Limited by FW for best performance

⁷ Depends on atmospheric conditions, baseline length, GNSS antenna, multipath conditions, satellite visibility and geometry

⁸ Measured with 1 km baseline, patch antennas with ground planes; GPS + BeiDou measured in Singapore

⁹ CEP, 50%, 24 hours static, -130 dBm, > 6 SVs

¹⁰ ppm limited to baselines up to 10 km

1.4 Block diagram

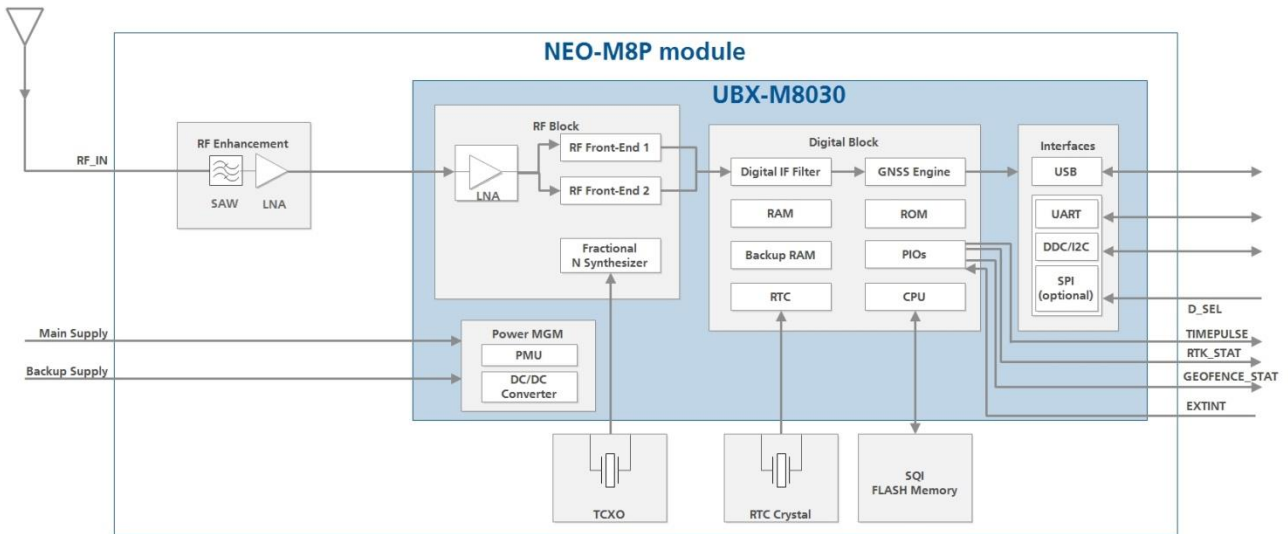

Figure 1: NEO-M8P block diagram

1.5 GNSS

The NEO-M8P positioning modules are concurrent GNSS receivers that can receive and track multiple GNSS systems. NEO-M8P receivers are by default configured for concurrent GPS and GLONASS reception. A combination of GPS and BeiDou can also be used. If RTK update rate is a key factor, the receiver should be configured to use only GPS.

1.5.1 GPS

The NEO-M8P positioning modules are designed to receive and track the L1C/A signals provided at 1575.42 MHz by the Global Positioning System (GPS).

1.5.2 BeiDou

The NEO-M8P modules can receive and process the B1I signals broadcast at 1561.098 MHz from the BeiDou Navigation Satellite System. The ability to receive and track BeiDou signals in conjunction with GPS results in higher coverage, improved reliability and better accuracy. Currently, BeiDou is not fully operational globally and provides Chinese regional coverage only. Global coverage is scheduled for 2020.

1.5.3 GLONASS

The NEO-M8P positioning modules can receive and process GLONASS concurrently with GPS. The NEO-M8P modules are designed to receive and track the L1OF signals GLONASS provides at $1602 \text{ MHz} + k \cdot 562.5 \text{ kHz}$, where k is the satellite's frequency channel number ($k = -7, -6, \dots, 5, 6$). The ability to receive and track GLONASS L1OF satellite signals allows design of GLONASS receivers where required by regulations.

1.6 RTK operation

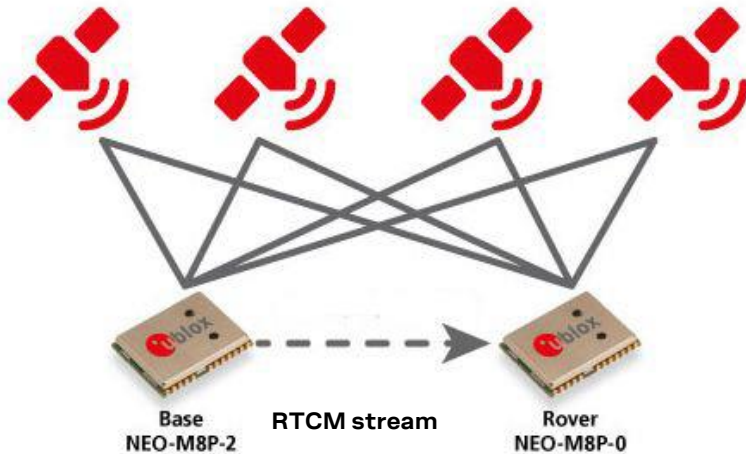

Figure 2: The M8P modules work as a pair, where the base provides a stream of RTCM messages to the rover

Under RTK operation, the M8P modules operate as a pair consisting of a rover and a base. The rover needs access to a stream of RTCM 3 messages before it can enter RTK mode and before centimeter-level accuracies can be reached. The various concepts are explained in detail below.

1.6.1 Rover navigation modes

In its default configuration the NEO-M8P rover attempts to provide the best positioning accuracy depending on the received correction data. It will enter RTK Float mode as soon as it receives an input stream of RTCM 3 messages. Once the rover has resolved the carrier phase ambiguities, it enters RTK Fixed mode. When the rover is in RTK Fixed mode, it can be expected that the relative accuracies are correct to the cm-level.

It will typically take less than 60 s before the rover has been able to solve the carrier ambiguities and go from RTK Float mode to RTK Fixed mode. The length of this time period is referred to as the convergence time.

The rover will attempt to provide RTK fixed mode when 5 or more ambiguities can be estimated. For single-constellation receivers, this means that at least 6 satellites with continuous phase lock need to be visible above the elevation mask (default 10°). Adding satellites from an additional constellation requires at least 2 satellites to form the double difference measurement. Hence, with dual GPS and GLONASS operation, a minimum would consist of 7 satellites (for example, 5 GPS + 2 GLONASS). However, use with additional BeiDou satellites would require 8 satellites (for example, 5 GPS + 3 BeiDou) owing to the two different BeiDou satellite variants.

The rover drops back to RTK Float mode if it loses carrier phase lock on the minimum amount of signals needed to maintain RTK Fixed mode. The rover continues to attempt to resolve carrier ambiguities and go back to the RTK Fixed mode once the minimum number of signals has been restored.

If RTCM 3 corrections become unavailable, the rover will run as a standalone standard precision receiver.

The command `UBX-CFG-DGNSS` can be used to specify that the receiver should stay in RTK Float mode and that it should not attempt to fix integer ambiguities.

The current operation mode is indicated by relevant NMEA and UBX-NAV messages; see the u-blox 8 / u-blox M8 Receiver Description Including Protocol Specification [2].

1.6.1.1 Relative and absolute position

In RTK mode the rover calculates its position relative to the location of the base position. The relative accuracy can at best be correct to the centimeter level. To get an accuracy that is optimal in an absolute sense, the accuracy of the base station position must be optimized. In the UBX-NAV-RELPOSNED message, the relative position is described in the form of an NED vector.

The absolute accuracy of the base station position will be transferred to the absolute accuracy of a rover operating in differential mode. The NEO-M8P-2 base station module comes with functionalities to ensure the best possible absolute accuracy as described in section [1.6.2](#).

1.6.2 Base station mode (NEO-M8P-2)

The NEO-M8P-2 can be set-up to operate either as a static or as a mobile base station using the appropriate configuration messages. Prior to use, the NEO-M8P-2 must be configured to produce the required RTCM messages using UBX-CFG-MSG. For static operation, the user has a choice of providing a set of position coordinates explicitly, or by commanding the receiver to produce its own via a self-survey-in function. When either mode is set correctly with a valid position, RTCM reference position messages will be enabled for transmission. When setting for a moving base station mode, the base receiver must ensure that the fixed location mode is disabled and the reference transmits the RTCM 4072 message.

1.6.2.1 Static mode

The NEO-M8P-2 can be set to use previously surveyed coordinates of the base antenna position. Assuming such coordinates are of highest quality, this method ensures the best absolute accuracy for the rover units. The device outputs RTCM 3 messages when successfully configured in this mode.

This mode is set by using the command UBX-CFG-TMODE3 with receiver mode flag “Fixed Mode”. The input WGS84 coordinates can be given in LAT/LON/ALT or ECEF format. Once set, the base station monitors its position in order to detect any position change from its designated position. Position changes larger than 100 m are reported via a warning message.

The NEO-M8P-2 is capable of self-surveying-in its coordinates in situations where the base antenna is not surveyed using other means. When this mode is employed the user provides constraints on accuracy and a minimum observation time. The receiver will average its position estimates and output any configured RTCM 3 observation messages until both constraints are met. After this, it will begin operating in static mode and outputs a configured RTCM 3 reference station message.

This mode is set by using the command UBX-CFG-TMODE3 with the mode flag “Survey In” set. The input WGS84 coordinates can be given in LAT/LON/ALT or ECEF format.

1.6.2.2 Moving baseline mode

The moving baseline (MB) mode differs from the standard RTK operation in that the base station is no longer stationary at a pre-determined location. Both the reference station and rover receivers are allowed to move while computing an accurate vector between the receiver's antennae. To ensure operation in this mode, use the message UBX-CFG-TMODE3 with the mode flag “disabled” set, and ensure that the RTCM 4072 message has been enabled.

This mode enables the calculation of heading on dynamic or static platforms, plus provides a centimeter level accurate 3D vector for use in dynamic positioning examples, for example, a UAV “follow me” feature.

1.6.2.3 Attitude sensing

Using the moving baseline functionality with fixed base and rover antenna positions on a platform gives the means to estimate the baseline angle with respect to the local datum via the relative position information. This derived angular error will then be proportional to the baseline length. Figure

3 below provides the trend for baseline lengths up to 1 m for a typical (1 sigma) relative position error of 0.8 cm.

 When using similar low-cost patch antennas it is best to match their orientation to ensure the best error estimate.

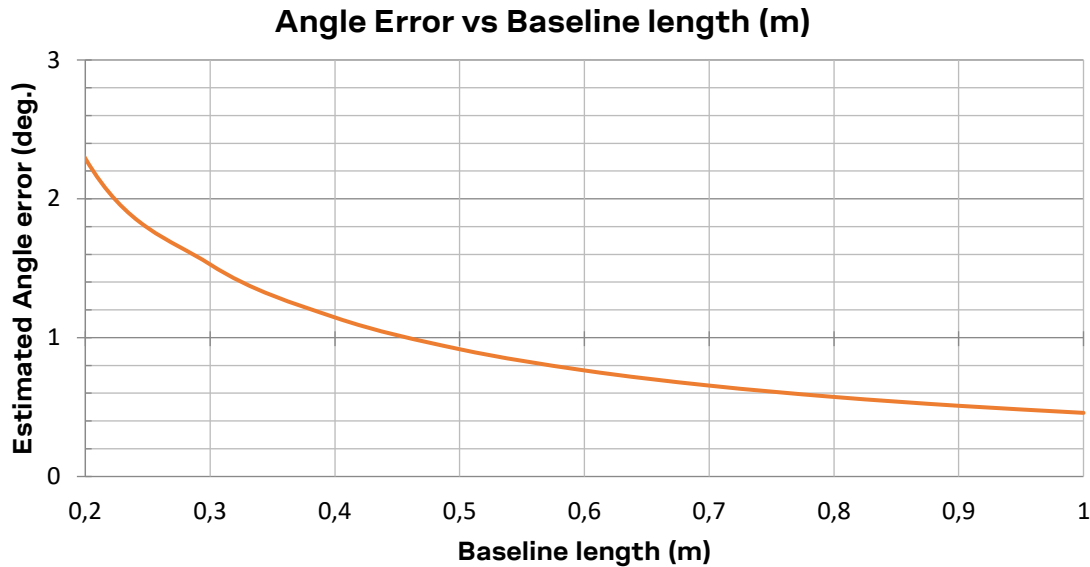

Figure 3: Estimated angular error for fixed base-line with a typical 1 sigma (0.08 cm) relative position error

1.6.3 RTCM message requirements

In static mode, it is critical that the RTCM observation messages (for example, RTCM 1077 and RTCM 1087, or RTCM 1077 and RTCM 1127) be generated from the same navigation epoch. This might not be the case when the messages are enabled individually at a lower rate than the navigation rate. For this reason, the user should configure the navigation rate of the reference station to be the same as the desired RTCM observation message rate. For this mode, the RTCM standard recommends using 1 Hz.

In moving baseline mode, it is critical that the base sends the position (RTCM 4072) and observation (RTCM 1077 and RTCM 1087, or RTCM 1077 and RTCM 1127) messages at the same rate as its navigation rate. Additionally, to ensure optimal performance, the base and rover receiver should use the same navigation rate.

To ensure GLONASS ambiguity fixing, the reference station must be configured to output RTCM message 1230. This message can be sent at a rate lower than the observation messages as the bias values will be held until a new version of the message is received.

The communication link from the base to the rover must be reliable. Breaks in this communication will result in the rover solution degrading, and eventually falling back to an independent navigation fix, dependent on configuration setting. The RTCM messages output from the base are by default configured to the recommended 1-Hz output rate. Corrections from a static base for GPS/GLONASS (or GPS/BeiDou) at this navigation rate will amount to a load of approximately 500 bytes/s, assuming an update rate of 1 Hz using MSM7 corrections for 20 GPS/GLONASS (or GPS/BeiDou) satellites.

 To reduce the load in static mode it is possible to use MSM4 instead of MSM7 messages. In this case, the load will reduce to approximately 300 bytes/s.

For a base operating at 4-Hz in moving baseline mode, assuming 20 GPS/GLONASS (or GPS/BeiDou) satellites, the load will increase to approximately 2 kB/s.

 In moving baseline mode, it is not possible to use MSM4 messages.

When the module receives a valid stream of RTCM 3 messages, the **RTK_STAT** status pin is set into an alternating, blinking mode. The **RTK_STAT** status pin is set active low when the rover module is operating in RTK Fixed mode. The message UBX-RXM-RTCM will echo basic information about received RTCM input messages and can be used to monitor the quality of the communication link.

 For more details, see the u-blox 8 / u-blox M8 Receiver Description Including Protocol Specification [2].

1.7 Raw data

The NEO-M8P modules provide raw measurement data for civil L1 band GPS, GLONASS and BeiDou signals including pseudo-range and carrier phase, carrier Doppler frequency and message payloads. The data contained in the UBX-RXM-RAWX message follows the conventions of a multi-GNSS RINEX 3 observation file and includes pseudo-range, carrier phase and Doppler measurements along with measurement quality data. The UBX-RXM-SFRBX message provides the demodulated, parity-checked navigation and signaling message bits for each satellite currently tracked by the receiver.

Raw measurement data are available once the receiver has established data bit synchronization and time-of-week. Message data are available for all signals tracked at a sufficient level to achieve data bit and frame synchronization. For more information, see the u-blox 8 / u-blox M8 Receiver Description Including Protocol Specification [2].

1.8 Assisted GNSS (A-GNSS)

Supply of aiding information, such as ephemeris, almanac, approximate position and time, will reduce the time to first fix significantly and improve the acquisition sensitivity. The NEO-M8P products support the u-blox AssistNow Online and are OMA SUPL compliant.

1.8.1 AssistNow™ Online

With AssistNow Online, an internet-connected GNSS device downloads assistance data from u-blox's AssistNow Online Service at system start-up. AssistNow Online is network-operator independent and globally available. Devices can be configured to request only ephemeris data for those satellites currently visible at their location, thus minimizing the amount of data transferred.

 For more details, see the u-blox 8 / u-blox M8 Receiver Description Including Protocol Specification [2] and MGA Services user guide [5].

1.9 Augmentation systems

1.9.1 Differential GNSS (DGNSS)

When operating in RTK mode RTCM version 3 messages are required and the NEO-M8P supports DGNSS according to RTCM 10403.2 [6]. The RTCM implementation in the rover and base-station variants provides decoding of the following RTCM 3.2 messages:

Message type	Description
1001	GPS L1 observations
1002	GPS L1 observations
1003	GPS L1/L2 observations
1004	GPS L1/L2 observations
1005	Station coordinates
1006	Station coordinates

Message type	Description
1007	Station Antenna Information
1009	GLONASS L1 observations
1010	GLONASS L1 observations
1011	GLONASS L1/L2 observations
1012	GLONASS L1/L2 observations
1074	MSM4 GPS observations
1075	MSM5 GPS observations
1077	MSM7 GPS observations
1084	MSM4 GLONASS observations
1085	MSM5 GLONASS observations
1087	MSM7 GLONASS observations
1124	MSM4 BeiDou observations
1125	MSM5 BeiDou observations
1127	MSM7 BeiDou observations
1230	GLONASS code-phase biases
4072	Reference station PVT (u-blox proprietary RTCM Message)

Table 2: Supported decoding of RTCM 3.2 messages

The RTCM implementation in the base station (NEO-M8P-2) generates the following RTCM 3.2 output messages:

Message type	Description
1005	Station coordinates
1074	MSM4 GPS observations
1077	MSM7 GPS observations
1084	MSM4 GLONASS observations
1087	MSM7 GLONASS observations
1124	MSM4 BeiDou observations
1127	MSM7 BeiDou observations
1230	GLONASS code-phase biases
4072	Reference station PVT (u-blox proprietary RTCM Message)

Table 3: Supported encoding of RTCM 3.2 messages

1.10 Data logging

The u-blox NEO-M8P receivers can be used in data logging applications. The data logging feature enables continuous storage of position, velocity and time information to an onboard SQL flash memory. It can also log distance from an odometer function. The logged data can be downloaded from the receiver later for further analysis or for conversion to a mapping tool. For more information, see the u-blox 8 / u-blox M8 Receiver Description Including Protocol Specification [2].



Note that the location information stored is standard precision only.

1.11 Host interface signature

The host interface signature mechanism provides protection against unauthorized tampering of the message data sent from the receiver to its host. This increases the robustness of the system against alteration of position and/or time information sent from the receiver (UART). Nominated messages are effectively 'signed' by the receiver using a hashing algorithm to generate a signature message for subsequent checking at the host. A dynamic 'seeding' of the algorithm can be used to detect time

shifted replay attacks on the received message data. See the u-blox 8 / u-blox M8 Receiver Description Including Protocol Specification [2] for more information.

1.12 Geofencing

The geofencing feature allows for the configuration of up to four circular areas (geofences) on the earth's surface. The receiver will then evaluate for each of these areas whether the current position lies within the area or not, and signal the state via UBX messaging and PIO toggling. Geofencing can be configured using the UBX-CFG-GEOFENCE message; the geofence evaluation is active whenever there is at least one geofence configured.

The NEO-M8P module uses pin 16 as the **GEOFENCE_STAT** status pin. This is asserted active low to indicate any position within the combined geofence areas.

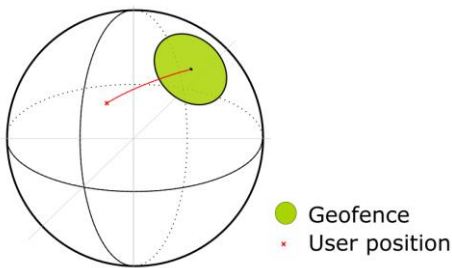



Figure 4: Illustration of the Geofence boundary

1.13 TIMEPULSE

A configurable timepulse signal is available with the NEO-M8P modules.

The TIMEPULSE output generates pulse trains synchronized with a GPS or UTC time grid with intervals configurable over a wide frequency range. Thus it may be used as a low-frequency time synchronization pulse or as a high-frequency reference signal.

-  The NEO-M8P timepulse output is configured using messages for "TIMEPULSE2." This pin has a secondary function during start-up (initiation of "SAFEBOOT" mode for firmware recovery) and should not normally be held LO during start-up.

By default the time pulse signal is disabled and, if required, can be activated using UBX-CFG-TP5. For more information, see the u-blox 8 / u-blox M8 Receiver Description including Protocol Specification [2].

1.14 Protocols and interfaces

Protocol	Type
NMEA 0183 V4.0 (V2.1, V2.3 and V4.1 configurable)	Input/output, ASCII
UBX	Input/output, binary, u-blox proprietary
RTCM 3.2	Input, for RTK
RTCM 3.2	Output (NEO-M8P-2 only)

Table 4: Available protocols

All protocols are available on UART, USB, DDC (I2C-compliant) and SPI. For specification of the various protocols see the u-blox 8 / u-blox M8 Receiver Description Including Protocol Specification [2].

-  When the NMEA protocol is used, version V4.1 is needed to provide all the related RTK information flags.

1.15 Interfaces

A number of interfaces are provided either for data communication or memory access. The embedded firmware uses these interfaces according to their respective protocol specifications.

1.15.1 UART

The NEO-M8P modules include one UART interface, which can be used for communication to a host. It supports configurable baud rates. For supported baud rates, see the u-blox 8 / u-blox M8 Receiver Description Including Protocol Specification [2].

 Designs must allow access to the UART and the **SAFEBOOT_N** function pin for future service, updates and reconfiguration.

1.15.2 USB

A USB version 2.0 FS-compatible interface can be used for communication as an alternative to the UART. The pull-up resistor on pin **USB_DP** is integrated to signal a full-speed device to the host. The **VDD_USB** pin supplies the USB interface.

u-blox offers USB drivers for use with Windows operating systems. For Windows 7, 8 and 10, there is a sensor driver for users who wish to connect to the Windows sensor platform. For users who wish to connect multiple devices or require a virtual com port, Windows 10 users can use the built-in driver, otherwise u-blox provide a standard USB driver (CDC-ACM) for Windows Vista and Windows 7 and 8. Windows drivers can be downloaded from the u-blox.com web site.

1.15.3 SPI

The SPI interface is designed to allow communication to a host CPU. The interface can be operated in slave mode only. The maximum transfer rate using SPI is 125 kB/s and the maximum SPI clock frequency is 5.5 MHz. Note that SPI is not available in the default configuration, because its pins are shared with the UART and DDC interfaces. The SPI interface can be enabled by connecting **D_SEL** (pin 2) to ground (see section 3.1).

1.15.4 Display Data Channel (DDC)

An I2C-compliant DDC interface is available for communication with an external host CPU or u-blox cellular modules. The interface can be operated in slave mode only. The DDC protocol and electrical interface are fully compatible with Fast-Mode of the I2C industry standard. Since the maximum SCL clock frequency is 400 kHz, the maximum transfer rate is 400 kbit/s.

1.16 EXTINT: External interrupt

EXTINT is an external interrupt pin with fixed input voltage thresholds with respect to VCC. It can be used for control of the receiver or for aiding.

For more information about how to implement and configure these features, see the u-blox 8 / u-blox M8 Receiver Description including Protocol Specification [2] and the NEO-M8P Hardware Integration Manual [1].

1.17 Clock generation

1.17.1 Oscillators

The NEO-M8P GNSS modules incorporate a TCXO for accelerated weak signal acquisition, faster start and reacquisition. These TCXOs are carefully selected and screened for stability and against frequency perturbations across the full operating range (−40 °C to +85 °C).

1.17.2 Real-time clock (RTC)

The RTC is driven by a 32-kHz oscillator using an RTC crystal. If the main supply voltage fails, and a battery is connected to V_BCKP, parts of the receiver switch off, but the RTC still runs providing a timing reference for the receiver. This operating mode is called hardware backup mode, which enables all relevant data to be saved in the backup RAM to allow a hot or warm start later.

1.18 Power management

u-blox M8 technology offers a power-optimized architecture with built-in autonomous power saving functions to minimize power consumption at any given time. In addition, a high efficiency DC-DC converter is integrated for lower power consumption and reduced power dissipation.

 For more details, see the u-blox 8 / u-blox M8 Receiver Description Including Protocol Specification [2].

1.18.1 Power control

A separate battery backup voltage may be applied to the module to retain the current state of the receiver and sustain a low power real time clock (RTC) while the main supply is removed. This enables faster acquisition and navigation upon start-up.

Alternatively, a configuration command (UBX-CFG-PWR) can be issued to stop the receiver in a similar way to hardware backup mode (see also 1.17.2 above) while the main supply remains active. This mode is referred to as software backup mode; current consumption in this mode is slightly higher than in hardware backup mode. The receiver will then restart on the next edge received at its UART interface (there will be a delay before any communications are possible).

See Table 11 for current consumption in backup modes.

1.19 Antenna

u-blox recommends using an active antenna¹¹ or an external LNA with this module to achieve the best performance.

Parameter	Specification	
Antenna type	Active or passive antenna	
Active antenna recommendations	Minimum gain	15 dB (to compensate signal loss in RF cable)
	Maximum gain	50 dB
	Maximum noise figure	1.5 dB

Table 5: Antenna specifications for the NEO-M8P modules

The antenna system should include filtering to ensure adequate protection from nearby transmitters. Care should be taken in the selection of antennas placed closed to cellular or Wi-Fi transmitting antennas.

 For guidance on antenna selection, see the NEO-M8P Hardware integration manual [1].

¹¹ For information on using active antennas with NEO-M8P modules, see the NEO-M8P Hardware integration manual[1].

2 Pin definition

2.1 Pin assignment

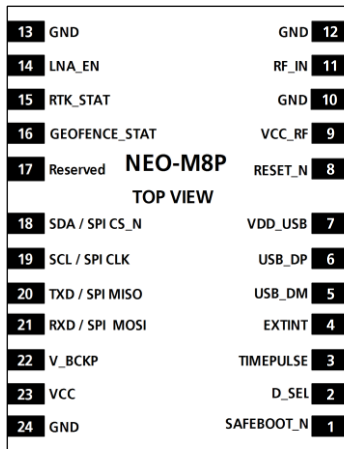



Figure 5: Pin assignment

No	Name	I/O	Description
1	SAFEBOOT_N	I	SAFEBOOT_N (for future service, updates and reconfiguration, leave OPEN)
2	D_SEL	I	Interface select
3	TIMEPULSE	O	Timepulse (1PPS)
4	EXTINT	I	External interrupt pin
5	USB_DM	I/O	USB data
6	USB_DP	I/O	USB data
7	VDD_USB	I	USB supply
8	RESET_N	I	RESET_N
9	VCC_RF	O	Output voltage RF section
10	GND	I	Ground
11	RF_IN	I	GNSS signal input
12	GND	I	Ground
13	GND	I	Ground
14	LNA_EN	O	Antenna / External LNA power control
15	RTK_STAT	O	RTK status: 0 – Fixed, blinking – receiving RTCM data, 1 – No corrections
16	GEOFENCE_STAT	O	Geofence status, user-defined
17	Reserved	-	Reserved
18	SDA / SPI CS_N	I/O	DDC data if D_SEL = 1 (or open) SPI chip select if D_SEL = 0
19	SCL / SPI CLK	I/O	DDC clock if D_SEL = 1(or open) SPI clock if D_SEL = 0
20	TxD / SPI MISO	O	Serial port if D_SEL = 1(or open) SPI MISO if D_SEL = 0
21	RxD / SPI MOSI	I	Serial port if D_SEL = 1(or open) SPI MOSI if D_SEL = 0
22	V_BCKP	I	Backup voltage supply
23	VCC	I	Supply voltage
24	GND	I	Ground

Table 6: Pinout

 Do not use pins designated “Reserved”. For more information about pinouts, see the NEO-M8P Hardware integration manual [1].

2.2 Pin name changes

Selected pin names have been updated to agree with a common naming convention across u-blox modules. The pins have not changed their operation and are the same physical hardware but with updated names. The table below lists the pins that have a changed name along with their old and new names.

No.	Previous name	New name
14	ANT_ON	LNA_EN
20	TxD SPI MISO	TXD/ SPI MISO
21	RxD SPI MOSI	RXD/ SPI MOSI

Table 7: NEO-M8P module pin renaming

3 Configuration management

Configuration settings can be modified with UBX configuration messages. The modified settings remain effective until power-down or reset. Settings can also be saved in battery-backed RAM, flash, or both, using the UBX-CFG-CFG message. If the settings have been stored in battery-backed RAM, the modified configuration will be retained as long as the backup battery supply at **V_BCKP** is not interrupted. Settings stored in flash memory will remain effective even after power-down and do not require a backup battery supply.

3.1 Interface selection (D_SEL)

At startup, pin 2 (**D_SEL**) determines which data interfaces are used for communication. If **D_SEL** is set high or left open, UART and DDC become available. If **D_SEL** is set low, that is, connected to ground, the NEO-M8P module can communicate to a host via SPI.

Pin no.	D_SEL="1" (left open)	D_SEL="0" (connected to GND)
20	UART TX	SPI MISO
21	UART RX	SPI MOSI
19	DDC SCL	SPI CLK
18	DDC SDA	SPI CS_N

Table 8: Data interface selection by D_SEL

4 Electrical specification

The limiting values given are in accordance with the Absolute Maximum Rating System (IEC 134). Stress above one or more of the limiting values may cause permanent damage to the device. These are stress ratings only and operation of the device at these or at any other conditions above those given in the characteristics sections of the specification is not implied. Exposure to these limits for extended periods may affect device reliability.

Where application information is given, it is advisory only and does not form part of the specification. For more information see, the NEO-M8P Hardware integration manual [1].

4.1 Absolute maximum rating

Parameter	Symbol	Condition	Min	Max	Units
Power supply voltage	VCC		-0.5	3.6	V
Backup battery voltage	V_BCKP		-0.5	3.6	V
USB supply voltage	VDD_USB		-0.5	3.6	V
Input pin voltage	V _{IN}		-0.5	3.6	V
	V _{IN_USB}		-0.5	VDD_USB	V
	V _{RFIN}		0	6	V
DC current through any digital I/O pin (except supplies)	I _{PIN}			10	mA
VCC_RF output current	ICC_RF			100	mA
Input power at RF_IN	P _{RFIN}	source impedance = 50 Ω, continuous wave		15	dBm
Storage temperature	T _{STG}		-40	85	°C

Table 9: Absolute maximum ratings

Stressing the device beyond the “Absolute Maximum Ratings” may cause permanent damage. These are stress ratings only. The product is not protected against overvoltage or reversed voltages. If necessary, voltage spikes exceeding the power supply voltage specification, given in table above, must be limited to values within the specified boundaries by using appropriate protection diodes.

4.2 Operating conditions

All specifications are at an ambient temperature of +25 °C. Extreme operating temperatures can significantly impact specification values. Applications operating near the temperature limits should be tested to ensure the specification.

Parameter	Symbol	Min	Typical	Max	Units	Condition
Power supply voltage	VCC	2.7	3.0	3.6	V	
Supply voltage USB	VDD_USB	3.0	3.3	3.6	V	
Backup battery voltage	V_BCKP	1.4		3.6	V	
Backup battery current	I_BCKP		15		μA	V_BCKP = 1.8 V, VCC = 0 V
SW backup current	I_SWBCKP		30		μA	VCC = 3 V
Input pin voltage range	V _{IN}	0		VCC	V	
Digital IO pin low level input voltage	V _{IL}	0		0.2*VCC	V	
Digital IO pin high level input voltage	V _{IH}	0.7*VCC		VCC	V	

Parameter	Symbol	Min	Typical	Max	Units	Condition
Digital IO pin low level output voltage	V_{OL}			0.4	V	$I_{OL} = 4 \text{ mA}$
Digital IO pin high level output voltage	V_{OH}	$V_{CC}-0.4$			V	$I_{OH} = 4 \text{ mA}$
Pull-up resistor for RESET_N	R_{PU}		11		k Ω	
USB_DM, USB_DP	V_{INU}	Compatible with USB with 27 Ω series resistance				
VCC_RF voltage	V_{CC_RF}		$V_{CC}-0.1$		V	
VCC_RF output current	I_{CC_RF}			50	mA	
Receiver Chain Noise Figure ¹²	NF_{TOT}		3		dB	
Operating temperature	T_{OPR}	-40		85	$^{\circ}\text{C}$	

Table 10: Operating conditions

Operation beyond the specified operating conditions can affect device reliability.

4.3 Indicative current requirements

Table 11 lists examples of the total system supply current for a possible application.

Values in [Table 11](#) are provided for customer information only as an example of typical power requirements. Values are characterized on samples, actual power requirements can vary depending on firmware version used, external circuitry, number of satellites tracked, signal strength, type of start as well as time, duration and conditions of test.

Parameter	Symbol	Typical GPS & GLONASS	Typical GPS	Max	Units	Condition
Max. supply current ¹³	ICCP			67	mA	
Average supply current ^{14,15}	ICC Acquisition ¹⁶	35	27		mA	Estimated at 3 V
	ICC Tracking (continuous mode)	33	25		mA	Estimated at 3 V

Table 11: Indicative power requirements at 3.0 V

For more information about power requirements, see the NEO-M8P Hardware Integration Manual [1].

For more information on how to noticeably reduce current consumption, see the Power Management Application Note [4].

4.4 SPI timing diagrams

In order to avoid incorrect operation of the SPI, the user needs to comply with certain timing conditions. The following signals need to be considered for timing constraints:

Symbol	Description
SPI CS_N (SS_N)	Slave select signal
SPI CLK (SCK)	Slave clock signal

Table 12: Symbol description

¹² Only valid for the GPS band.

¹³ Use this figure to dimension maximum current capability of power supply. Measure this parameter with 1-Hz bandwidth.

¹⁴ Use this figure to determine required battery capacity.

¹⁵ Simulated GNSS constellation using power levels of -130 dBm. $V_{CC} = 3.0 \text{ V}$.

¹⁶ Average current from start-up until the first fix.

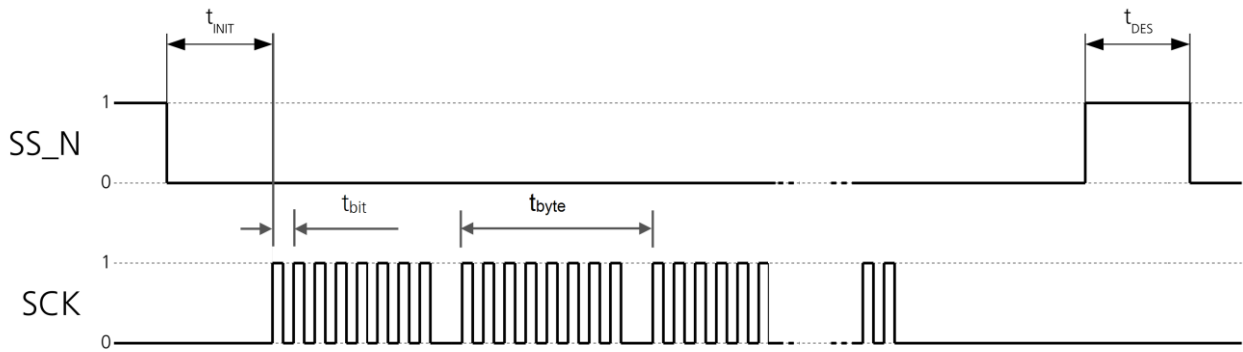

Figure 6: SPI timing diagram

4.4.1 Timing recommendations

The recommendations below are based on a firmware running from flash memory.

Parameter	Description	Recommendation
t_{INIT}	Initialization time	>10 μ s
t_{DES}	Deselect time	1 ms
t_{bit}	Minimum bit time	180 ns (5.5 MHz max bit frequency)
t_{byte}	Minimum byte period	8 μ s (125 kHz max byte frequency)

Table 13: SPI timing recommendations

The values in Table 13 result from the requirement of an error-free transmission. For more information, see the u-blox 8 / u-blox M8 Receiver Description Including Protocol Specification [2].

4.5 DDC timing

The DDC interface is I2C Fast Mode compliant. For timing parameters, consult the I2C standard.

The maximum bit rate is 400 kbit/s. The interface stretches the clock when slowed down when serving interrupts, so real bit rates may be slightly lower.

5 Mechanical specifications

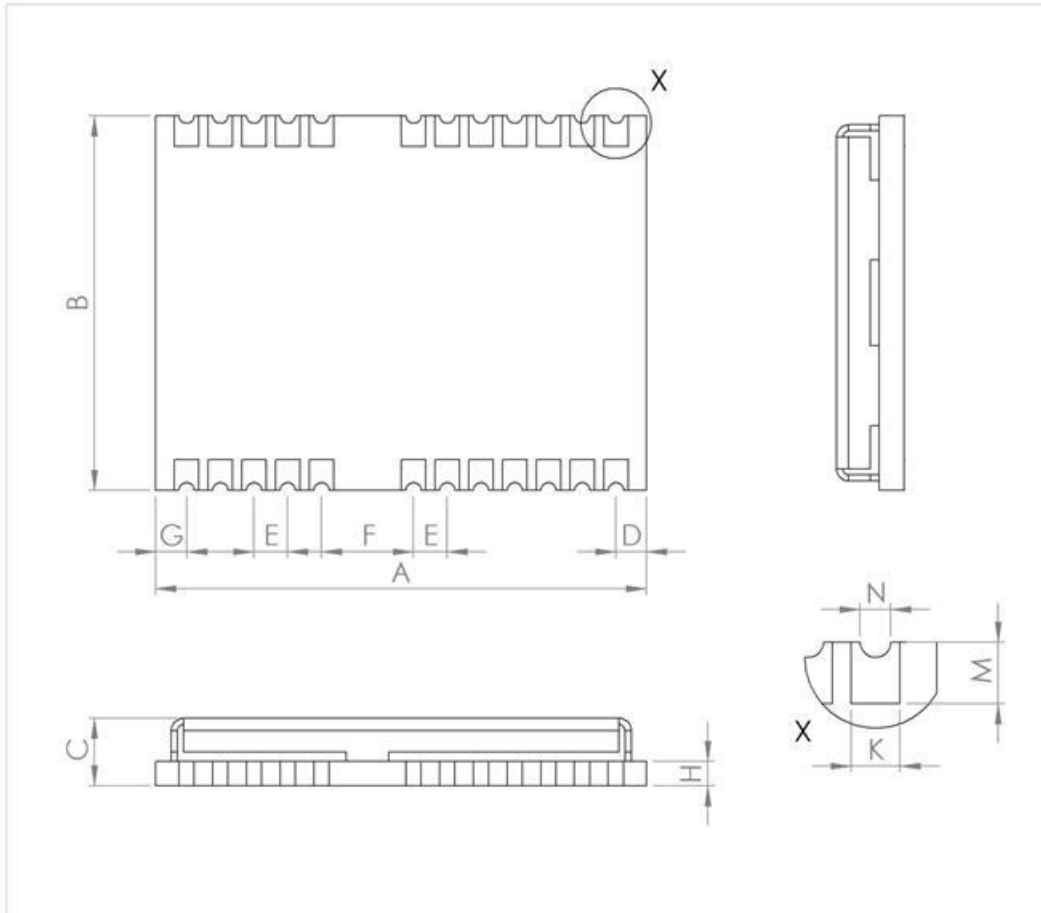

Symbol	Min. (mm)	Typ. (mm)	Max. (mm)
A	15.9	16.0	16.6
B	12.1	12.2	12.3
C	2.2	2.4	2.6
D	0.9	1.0	1.3
E	1.0	1.1	1.2
F	2.9	3.0	3.1
G	0.9	1.0	1.3
H		0.82	
K	0.7	0.8	0.9
M	0.8	0.9	1.0
N	0.4	0.5	0.6
Weight		1.6g	

Figure 7: Dimensions

For information about the paste mask and footprint, see the NEO-M8P Hardware integration manual [1].

6 Reliability tests and approvals

6.1 Reliability tests

 The NEO-M8P modules are based on AEC-Q100 qualified GNSS chips.

Tests for product family qualifications are according to ISO 16750 "Road vehicles – environmental conditions and testing for electrical and electronic equipment", and appropriate standards.

6.2 Approvals



Products marked with this lead-free symbol on the product label comply with the "Directive 2002/95/EC of the European Parliament and the Council on the Restriction of Use of certain Hazardous Substances in Electrical and Electronic Equipment" (RoHS).

All u-blox M8 GNSS modules are RoHS compliant.

7 Product handling and soldering

7.1 Packaging

To enable efficient production, production lot set-up and tear-down, the NEO-M8P GNSS modules are delivered as hermetically sealed, reeled tapes. For more information, see the u-blox Package Information Guide [3].

7.1.1 Reels

The NEO-M8P GNSS modules are deliverable in quantities of 250 pieces on a reel. The NEO-M8P receivers are shipped on Reel Type B, as specified in the u-blox Package Information Guide.

7.1.2 Tapes

The dimensions and orientations of the tapes for NEO-M8P GNSS modules are specified in Figure 8.

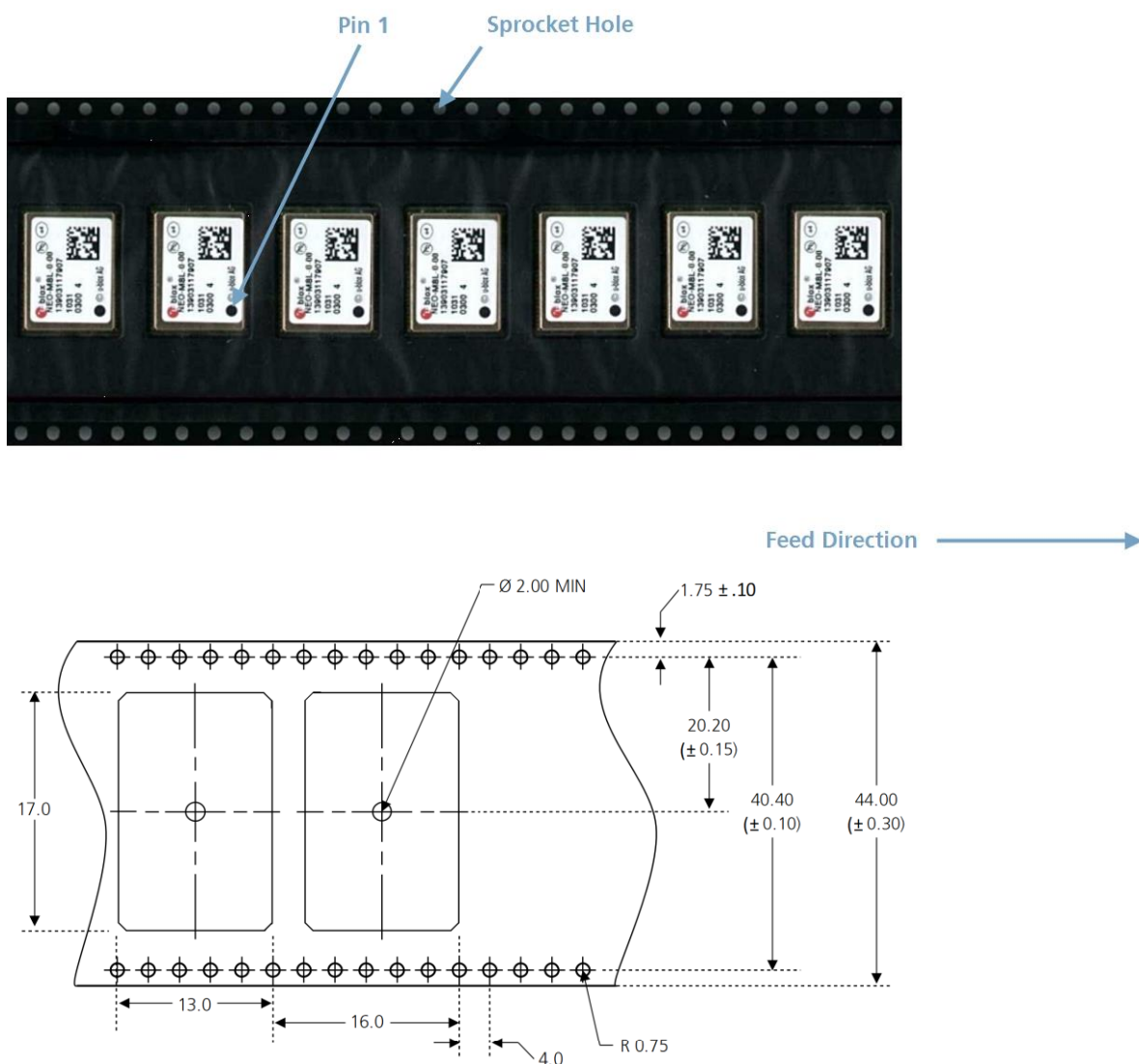

Figure 8: Dimensions and orientation for NEO-M8P modules on tape

7.2 Shipment, storage and handling

For important information regarding shipment, storage and handling, see the u-blox Package Information Guide [3].

7.2.1 Moisture sensitivity levels

The moisture sensitivity level (MSL) relates to the packaging and handling precautions required. The NEO-M8P modules are rated at MSL level 4.

For MSL standard see IPC/JEDEC J-STD-020, which can be downloaded from www.jedec.org.

For more information regarding MSL, see the u-blox Package Information Guide [3].

7.2.2 Reflow soldering

Reflow profiles are to be selected according u-blox recommendations (see the NEO-M8P Hardware integration manual [1]).

7.2.3 ESD handling precautions

NEO-M8P modules are Electrostatic Sensitive Devices (ESD). Observe precautions for handling! Failure to observe these precautions can result in severe damage to the GNSS receiver!

GNSS receivers are Electrostatic Sensitive Devices (ESD) and require special precautions when handling. Particular care must be exercised when handling patch antennas, due to the risk of electrostatic charges. In addition to standard ESD safety practices, the following measures should be taken into account whenever handling the receiver:

- Unless there is a galvanic coupling between the local GND (work table) and the PCB GND, the first point of contact when handling the PCB must always be between the local GND and PCB GND.
- Before mounting an antenna patch, connect ground of the device.
- When handling the RF pin, do not come into contact with any charged capacitors and be careful when contacting materials that can develop charges (e.g. patch antenna ~10 pF, coax cable ~50-80 pF/m, soldering iron).
- To prevent electrostatic discharge through the RF input, do not touch any exposed antenna area. If there is any risk that such exposed antenna area is touched in a non-ESD protected work area, implement proper ESD protection measures in the design.
- When soldering RF connectors and patch antennas to the receiver's RF pin, make sure to use an ESD safe soldering iron (tip).



8 Default messages

Interface	Settings
UART Output	9600 baud, 8 bits, no parity bit, 1 stop bit Configured to transmit both NMEA and UBX protocols, but only the following NMEA (and no UBX) messages have been activated at start-up: GGA, GLL, GSA, GSV, RMC, VTG, TXT
USB Output	Configured to transmit both NMEA and UBX protocols, but only the following NMEA (and no UBX) messages have been activated at start-up: GGA, GLL, GSA, GSV, RMC, VTG, TXT USB power mode: bus-powered
UART Input	9600 baud, 8 bits, no parity bit, 1 stop bit, autobauding disabled Automatically accepts following protocols without need of explicit configuration: UBX, NMEA, RTCM The GNSS receiver supports interleaved UBX and NMEA messages
USB Input	Automatically accepts following protocols without need of explicit configuration: UBX, NMEA The GPS receiver supports interleaved UBX and NMEA messages USB power mode: bus-powered
DDC	Fully compatible with the I2C industry standard, available for communication with an external host CPU or u-blox cellular modules, operated in slave mode only. Default messages activated. NMEA and UBX are enabled as input messages, only NMEA as output messages. Maximum bit rate 400 kbit/s.
SPI	Allow communication to a host CPU, operated in slave mode only. Default messages activated. SPI is not available in the default configuration.
TIMEPULSE	Disabled

Table 14: Default messages

 For information about further settings, refer to the u-blox 8 / u-blox M8 Receiver Description Including Protocol Specification [2].

9 Labeling and ordering information

9.1 Product labeling

The labeling of u-blox M8 GNSS modules includes important product information. The location of the NEO-M8P product type number is shown in Figure 9.

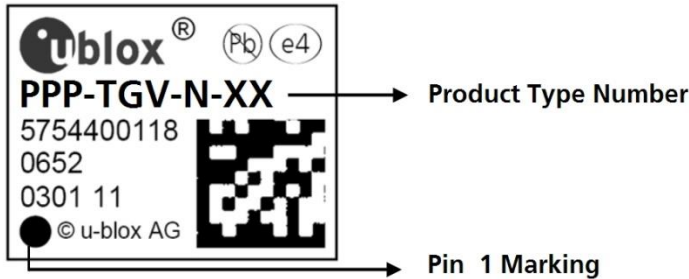

Figure 9: Location of product type number on the u-blox NEO-M8P module label

9.2 Explanation of codes

Three different product code formats are used. The **Product Name** is used in documentation such as this data sheet and identifies all u-blox M8 products, independent of packaging and quality grade. The **Ordering Code** includes options and quality, while the **Type Number** includes the hardware and firmware versions. Table 15 shows the structure of these three different formats.

Format	Structure
Product Name	PPP-TGV
Ordering Code	PPP-TGV-N
Type Number	PPP-TGV-N-XX

Table 15: Product code formats

The parts of the product code are explained in Table 16.

Code	Meaning	Example
PPP	Product Family	NEO
TG	Platform	M8 = u-blox M8
V	Variant	Function set (A-Z), T = Timing, R = DR, etc.
N	Option / Quality Grade	Describes standardized functional element or quality grade 0 = Default variant, A = Automotive
XX	Product Detail	Describes product details or options such as hard- and software revision, cable length, etc.

Table 16: Part identification code

9.3 Ordering codes

Ordering code	Product
NEO-M8P-0	u-blox M8 GNSS RTK module with rover functionality, 12.2x16 mm, 250 pcs/reel
NEO-M8P-2	u-blox M8 GNSS RTK module with rover and base station functionality, 12.2x16 mm, 250 pcs/reel

Table 17: Product ordering codes for NEO-M8P professional grade modules

Product changes affecting form, fit or function are documented by u-blox. For a list of Product Change Notifications (PCNs), see our website.

Appendix

A Glossary

Abbreviation	Definition
AEC	Automotive Electronics Council
BeiDou	Chinese satellite navigation system
CDMA	Code Division Multiple Access
DDC	Display Data Channel
EMC	Electromagnetic Compatibility
EMI	Electromagnetic Interference
EOS	Electrical Overstress
EPA	Electrostatic Protective Area
ESD	Electrostatic Discharge
GLONASS	Russian satellite navigation system
GND	Ground
GNSS	Global Navigation Satellite System
GPS	Global Positioning System
GSM	Global System for Mobile Communications
I2C	Inter-Integrated Circuit interconnect
IEC	International Electrotechnical Commission
ISO	International Standards Organization for Standardization
MB	Moving Baseline
NED	North East Down local Cartesian coordinates
NMEA	National Marine Electronics Association
PCB	Printed Circuit Board
PCN	Product Change Notification
QZSS	Quasi-Zenith Satellite System
RF	Radio Frequency
RTCM	Radio Technical Commission for Maritime Services
RTK	Real Time Kinematic
SPI	Serial Peripheral Interface
TCXO	Temperature Compensated Crystal Oscillator
UART	Universal Asynchronous Receiver/Transmitter
UAV	Unmanned Aerial Vehicle
USB	Universal Serial Bus

Table 18: Explanation of the abbreviations and terms used

Related documents

- [1] NEO-M8P Hardware integration manual, doc. no. [UBX-15021148](#)
- [2] u-blox 8 / u-blox M8 Receiver Description Including Protocol Specification (Public version), doc. no. [UBX-13003221](#)
- [3] u-blox Package Information Guide, doc. no. [UBX-14001652](#)
- [4] Power Management Application Note, doc. no. [UBX-13005162](#)
- [5] Multi-GNSS Assistance User guide, doc. no. [UBX-13004360](#)
- [6] RTCM 10403.2, Differential GNSS Services - Version 3 (February 2013)

 For regular updates to u-blox documentation and to receive product change notifications, register on our homepage (www.u-blox.com).

Revision history

Revision	Date	Name	Comments
R01	15-Oct-2015	mstr	Objective Specification
R02	15-Feb-2016	byou/mstr	Advance Information, updated to reflect FW3.01 HPG 1.00 status
R03	30-May-2016	byou/mstr	Updated to reflect FW3.01 HPG 1.11 status
R04	27-Sep-2016	byou	Updated to reflect FW3.01 HPG1.20 status
R05	19-Jan-2017	byou	Early Production Information, updated to reflect FW3.01 HPG1.30 status, updated section 1.6.3 (added statements for GLONASS ambiguity fixing and MSM4 messages), added MSM4 and GLONASS code-phase biases messages in Table 2 and Table 3.
R06	16-May-2017	byou	Early Production Information, updated to reflect FW3.01 HPG1.40 status. Updated section 1.6 - MB mode information and messages.
R07	2-Nov-2017	byou	Production Information.
R08	09-Mar-2020	smos/mala	Updated style to current CI. Added information on QZSS in section Product features. Reintroduced timepulse for NEO-M8P-0 (rover) in the Product features table.

Contact

For complete contact information, visit us at www.u-blox.com.

u-blox Offices

North, Central and South America

u-blox America, Inc.

Phone: +1 703 483 3180
E-mail: info_us@u-blox.com

Regional Office West Coast:

Phone: +1 408 573 3640
E-mail: info_us@u-blox.com

Technical Support:

Phone: +1 703 483 3185
E-mail: support@u-blox.com

Headquarters

Europe, Middle East, Africa

u-blox AG

Phone: +41 44 722 74 44
E-mail: info@u-blox.com
Support: support@u-blox.com

Asia, Australia, Pacific

u-blox Singapore Pte. Ltd.

Phone: +65 6734 3811
E-mail: info_ap@u-blox.com
Support: support_ap@u-blox.com

Regional Office Australia:

Phone: +61 2 8448 2016
E-mail: info_anz@u-blox.com
Support: support_ap@u-blox.com

Regional Office China (Beijing):

Phone: +86 10 68 133 545
E-mail: info_cn@u-blox.com
Support: support_cn@u-blox.com

Regional Office China (Chongqing):

Phone: +86 23 6815 1588
E-mail: info_cn@u-blox.com
Support: support_cn@u-blox.com

Regional Office China (Shanghai):

Phone: +86 21 6090 4832
E-mail: info_cn@u-blox.com
Support: support_cn@u-blox.com

Regional Office China (Shenzhen):

Phone: +86 755 8627 1083
E-mail: info_cn@u-blox.com
Support: support_cn@u-blox.com

Regional Office India:

Phone: +91 80 405 092 00
E-mail: info_in@u-blox.com
Support: support_in@u-blox.com

Regional Office Japan (Osaka):

Phone: +81 6 6941 3660
E-mail: info_jp@u-blox.com
Support: support_jp@u-blox.com

Regional Office Japan (Tokyo):

Phone: +81 3 5775 3850
E-mail: info_jp@u-blox.com
Support: support_jp@u-blox.com

Regional Office Korea:

Phone: +82 2 542 0861
E-mail: info_kr@u-blox.com
Support: support_kr@u-blox.com

Regional Office Taiwan:

Phone: +886 2 2657 1090
E-mail: info_tw@u-blox.com
Support: support_tw@u-blox.com