



**MICROCHIP**

---

**MIC2133**  
**Evaluation Board**  
**User's Guide**

---

**Note the following details of the code protection feature on Microchip products:**

- Microchip products meet the specifications contained in their particular Microchip Data Sheet.
- Microchip believes that its family of products is secure when used in the intended manner, within operating specifications, and under normal conditions.
- Microchip values and aggressively protects its intellectual property rights. Attempts to breach the code protection features of Microchip product is strictly prohibited and may violate the Digital Millennium Copyright Act.
- Neither Microchip nor any other semiconductor manufacturer can guarantee the security of its code. Code protection does not mean that we are guaranteeing the product is "unbreakable" Code protection is constantly evolving. Microchip is committed to continuously improving the code protection features of our products.

---

This publication and the information herein may be used only with Microchip products, including to design, test, and integrate Microchip products with your application. Use of this information in any other manner violates these terms. Information regarding device applications is provided only for your convenience and may be superseded by updates. It is your responsibility to ensure that your application meets with your specifications. Contact your local Microchip sales office for additional support or, obtain additional support at <https://www.microchip.com/en-us/support/design-help/client-support-services>.

THIS INFORMATION IS PROVIDED BY MICROCHIP "AS IS". MICROCHIP MAKES NO REPRESENTATIONS OR WARRANTIES OF ANY KIND WHETHER EXPRESS OR IMPLIED, WRITTEN OR ORAL, STATUTORY OR OTHERWISE, RELATED TO THE INFORMATION INCLUDING BUT NOT LIMITED TO ANY IMPLIED WARRANTIES OF NON-INFRINGEMENT, MERCHANTABILITY, AND FITNESS FOR A PARTICULAR PURPOSE, OR WARRANTIES RELATED TO ITS CONDITION, QUALITY, OR PERFORMANCE.

IN NO EVENT WILL MICROCHIP BE LIABLE FOR ANY INDIRECT, SPECIAL, PUNITIVE, INCIDENTAL, OR CONSEQUENTIAL LOSS, DAMAGE, COST, OR EXPENSE OF ANY KIND WHATSOEVER RELATED TO THE INFORMATION OR ITS USE, HOWEVER CAUSED, EVEN IF MICROCHIP HAS BEEN ADVISED OF THE POSSIBILITY OR THE DAMAGES ARE FORESEEABLE. TO THE FULLEST EXTENT ALLOWED BY LAW, MICROCHIP'S TOTAL LIABILITY ON ALL CLAIMS IN ANY WAY RELATED TO THE INFORMATION OR ITS USE WILL NOT EXCEED THE AMOUNT OF FEES, IF ANY, THAT YOU HAVE PAID DIRECTLY TO MICROCHIP FOR THE INFORMATION.

Use of Microchip devices in life support and/or safety applications is entirely at the buyer's risk, and the buyer agrees to defend, indemnify and hold harmless Microchip from any and all damages, claims, suits, or expenses resulting from such use. No licenses are conveyed, implicitly or otherwise, under any Microchip intellectual property rights unless otherwise stated.

For information regarding Microchip's Quality Management Systems, please visit [www.microchip.com/quality](http://www.microchip.com/quality).

**Trademarks**

The Microchip name and logo, the Microchip logo, Adaptec, AVR, AVR logo, AVR Freaks, BesTime, BitCloud, CryptoMemory, CryptoRF, dsPIC, flexPWR, HELDO, IGL00, JukeBlox, KeeLoq, Klear, LANCheck, LinkMD, maXStylus, maXTouch, MediaLB, megaAVR, Microsemi, Microsemi logo, MOST, MOST logo, MPLAB, OptoLyzer, PIC, picoPower, PICSTART, PIC32 logo, PolarFire, Prochip Designer, QTouch, SAM-BA, SenGenuity, SpyNIC, SST, SST Logo, SuperFlash, Symmetricom, SyncServer, Tachyon, TimeSource, tinyAVR, UNI/O, Vectron, and XMEGA are registered trademarks of Microchip Technology Incorporated in the U.S.A. and other countries.

AgileSwitch, APT, ClockWorks, The Embedded Control Solutions Company, EtherSynch, Flashtec, Hyper Speed Control, HyperLight Load, Libero, motorBench, mTouch, Powermite 3, Precision Edge, ProASIC, ProASIC Plus, ProASIC Plus logo, Quiet-Wire, SmartFusion, SyncWorld, Temux, TimeCesium, TimeHub, TimePictra, TimeProvider, TrueTime, and ZL are registered trademarks of Microchip Technology Incorporated in the U.S.A.

Adjacent Key Suppression, AKS, Analog-for-the-Digital Age, Any Capacitor, AnyIn, AnyOut, Augmented Switching, BlueSky, BodyCom, Clockstudio, CodeGuard, CryptoAuthentication, CryptoAutomotive, CryptoCompanion, CryptoController, dsPICDEM, dsPICDEM.net, Dynamic Average Matching, DAM, ECAN, Espresso T1S, EtherGREEN, GridTime, IdealBridge, In-Circuit Serial Programming, ICSP, INICnet, Intelligent Paralleling, IntelliMOS, Inter-Chip Connectivity, JitterBlocker, Knob-on-Display, KoD, maxCrypto, maxView, memBrain, Mindi, MiWi, MPASM, MPF, MPLAB Certified logo, MPLIB, MPLINK, MultiTRAK, NetDetach, Omniscient Code Generation, PICDEM, PICDEM.net, PICkit, PICtail, PowerSmart, PureSilicon, QMatrix, REAL ICE, Ripple Blocker, RTAX, RTG4, SAM-ICE, Serial Quad I/O, simpleMAP, SimpliPHY, SmartBuffer, SmartHLS, SMART-I.S., storClad, SQI, SuperSwitcher, SuperSwitcher II, Switchtec, SynchroPHY, Total Endurance, Trusted Time, TSHARC, USBCheck, VariSense, VectorBlox, VeriPHY, ViewSpan, WiperLock, XpressConnect, and ZENA are trademarks of Microchip Technology Incorporated in the U.S.A. and other countries.

SQTP is a service mark of Microchip Technology Incorporated in the U.S.A.

The Adaptec logo, Frequency on Demand, Silicon Storage Technology, and Symmcom are registered trademarks of Microchip Technology Inc. in other countries.

GestIC is a registered trademark of Microchip Technology Germany II GmbH & Co. KG, a subsidiary of Microchip Technology Inc., in other countries.

All other trademarks mentioned herein are property of their respective companies.

© 2022, Microchip Technology Incorporated and its subsidiaries.

All Rights Reserved.

ISBN: 978-1-6683-0970-4

## Table of Contents

<b>Preface</b> .....	<b>5</b>
Introduction.....	5
Document Layout .....	5
Conventions Used in this Guide .....	6
The Microchip Website .....	6
Customer Support .....	7
Document Revision History .....	7
<b>Chapter 1. Product Overview</b>	
1.1 Introduction .....	9
1.2 MIC2133 Overview .....	9
1.3 MIC2133 Key Features .....	9
1.4 MIC2133 Evaluation Board (EV66P64A) Kit Contents .....	10
<b>Chapter 2. Installation and Operation</b>	
2.1 Introduction .....	13
2.2 Setup and Configuration .....	14
<b>Appendix A. Schematic and Layouts</b>	
A.1 Introduction .....	15
A.2 EV66P64A Board – Schematic .....	16
A.3 EV66P64A Board – Top Silk .....	17
A.4 EV66P64A Board – Top Copper and Silk .....	17
A.5 EV66P64A Board – Top Copper .....	18
A.6 EV66P64A Board – Inner 1 Copper .....	18
A.7 EV66P64A Board – Inner 2 Copper .....	19
A.8 EV66P64A Board – Inner 3 Copper .....	19
A.9 EV66P64A Board – Inner 4 Copper .....	20
A.10 EV66P64A Board – Bottom Silk .....	20
A.11 EV66P64A Board – Bottom Copper and Silk .....	21
A.12 EV66P64A Board – Bottom Copper .....	21
<b>Appendix B. Bill of Materials (BOM)</b> .....	<b>23</b>
<b>Appendix C. Board Performance Curves and Waveforms</b>	
C.1 Reference Design Performance .....	27
C.2 Performance Curves .....	30
<b>Worldwide Sales and Service</b> .....	<b>33</b>

# MIC2133 Evaluation Board User's Guide

---

NOTES:

---

---

## Preface

---

---

### NOTICE TO CUSTOMERS

All documentation becomes dated, and this manual is no exception. Microchip tools and documentation are constantly evolving to meet customer needs, so some actual dialogs and/or tool descriptions may differ from those in this document. Please refer to our website ([www.microchip.com](http://www.microchip.com)) to obtain the latest documentation available.

Documents are identified with a “DS” number. This number is located on the bottom of each page, in front of the page number. The numbering convention for the DS number is “DSXXXXXXXXA”, where “XXXXXXXX” is the document number and “A” is the revision level of the document.

For the most up-to-date information on development tools, see the MPLAB® IDE online help. Select the Help menu, and then Topics to open a list of available online help files.

## INTRODUCTION

This chapter contains general information that will be useful to know before using the MIC2133 Evaluation Board (EV66P64A). Items discussed in this chapter include:

- [Document Layout](#)
- [Conventions Used in this Guide](#)
- [The Microchip Website](#)
- [Customer Support](#)
- [Document Revision History](#)

## DOCUMENT LAYOUT

This document describes how to use the MIC2133 Evaluation Board (EV66P64A) as a development tool. The manual layout is as follows:

- **Chapter 1. “Product Overview”** – Important information about the MIC2133 Evaluation Board (EV66P64A).
- **Chapter 2. “Installation and Operation”** – Includes instructions on how to get started with the MIC2133 Evaluation Board (EV66P64A) and a description of each function.
- **Appendix A. “Schematic and Layouts”** – Shows the schematic and layout diagrams for the MIC2133 Evaluation Board (EV66P64A).
- **Appendix B. “Bill of Materials (BOM)”** – Lists the parts used to build the MIC2133 Evaluation Board (EV66P64A).
- **Appendix C. “Board Performance Curves and Waveforms”** – Includes the board performance curves and waveforms for the MIC2133 Evaluation Board (EV66P64A).

# MIC2133 Evaluation Board User's Guide

## CONVENTIONS USED IN THIS GUIDE

This manual uses the following documentation conventions:

### DOCUMENTATION CONVENTIONS

Description	Represents	Examples
<b>Arial font:</b>		
Italic characters	Referenced books	<i>MPLAB<sup>®</sup> IDE User's Guide</i>
	Emphasized text	...is the <i>only</i> compiler...
Initial caps	A window	the Output window
	A dialog	the Settings dialog
	A menu selection	select Enable Programmer
Quotes	A field name in a window or dialog	"Save project before build"
Underlined, italic text with right angle bracket	A menu path	<u><i>File&gt;Save</i></u>
Bold characters	A dialog button	Click <b>OK</b>
	A tab	Click the <b>Power</b> tab
N'Rnnnn	A number in verilog format, where N is the total number of digits, R is the radix and n is a digit.	4'b0010, 2'hF1
Text in angle brackets < >	A key on the keyboard	Press <Enter>, <F1>
<b>Courier New font:</b>		
Plain Courier New	Sample source code	<code>#define START</code>
	Filenames	<code>autoexec.bat</code>
	File paths	<code>c:\mcc18\h</code>
	Keywords	<code>_asm, _endasm, static</code>
	Command-line options	<code>-Opa+, -Opa-</code>
	Bit values	<code>0, 1</code>
	Constants	<code>0xFF, 'A'</code>
Italic Courier New	A variable argument	<i>file.o</i> , where <i>file</i> can be any valid filename
Square brackets [ ]	Optional arguments	<code>mcc18 [options] file [options]</code>
Curly brackets and pipe character: {   }	Choice of mutually exclusive arguments; an OR selection	<code>errorlevel {0 1}</code>
Ellipses...	Replaces repeated text	<code>var_name [, var_name...]</code>
	Represents code supplied by user	<code>void main (void) { ... }</code>

## THE MICROCHIP WEBSITE

Microchip provides online support via our website at [www.microchip.com](http://www.microchip.com). This website is used as a means to make files and information easily available to customers. Accessible by using your favorite Internet browser, the website contains the following information:

- **Product Support** – Data sheets and errata, application notes and sample programs, design resources, user's guides and hardware support documents, latest software releases and archived software
- **General Technical Support** – Frequently Asked Questions (FAQs), technical support requests, online discussion groups, Microchip consultant program member listing
- **Business of Microchip** – Product selector and ordering guides, latest Microchip press releases, listing of seminars and events, listings of Microchip sales offices, distributors and factory representatives

## CUSTOMER SUPPORT

Users of Microchip products can receive assistance through several channels:

- Distributor or Representative
- Local Sales Office
- Field Application Engineer (FAE)
- Technical Support

Customers should contact their distributor, representative or field application engineer (FAE) for support. Local sales offices are also available to help customers. A listing of sales offices and locations is included in the back of this document.

Technical support is available through the website at:  
<https://www.microchip.com/support>.

## DOCUMENT REVISION HISTORY

### Revision A (July 2022)

- Initial release of this document.

# MIC2133 Evaluation Board User's Guide

---

NOTES:



---

---

## Chapter 1. Product Overview

---

---

### 1.1 INTRODUCTION

This chapter provides an overview of the MIC2133 Evaluation Board (EV66P64A) and covers the following topics:

- [MIC2133 Overview](#)
- [MIC2133 Key Features](#)
- [MIC2133 Evaluation Board \(EV66P64A\) Kit Contents](#)

### 1.2 MIC2133 OVERVIEW

MIC2133 is constant on-time, dual phase synchronous buck controller featuring a unique adaptive ON-time control architecture with HyperLight Load and phase-shedding features enabled. MIC2133 can be used with external MOSFETs and output filter to create a dual phase single output, high current switch mode power supply. It also operates over an input supply range from 4.5V to 75V and can be used to supply up to 50A of output current. The output voltage is adjustable down to 0.6V with a guaranteed accuracy of  $\pm 1\%$ . The device operates with programmable switching frequency from 100 kHz to 800 kHz per phase. MIC2133 is available in a 5 x 5 mm 32-pin VQFN package with a junction operating range from  $-40^{\circ}\text{C}$  to  $+125^{\circ}\text{C}$ .

The 75V rating of this device makes it attractive for applications such as communication, automotive and industrial, which have increasing requirements for additional voltage safety headroom.

### 1.3 MIC2133 KEY FEATURES

The MIC2133 Evaluation Board (EV66P64A) has the following features:

- Input Voltage Range: 4.5V to 75V
- Adjustable Output Voltage Range: 0.6V to 32V
- Adaptive Constant on Time Control
  - High Delta V Operation
  - Any Capacitor™ Stable
- 0.6V Internal Reference with  $\pm 1\%$  Accuracy
- Ripple Injection from Third Node which allows Greater Than 50% Duty Cycles
- HyperLight Load and Phase Shedding
- Automatic Phase Shedding of Secondary Phase
- Accurate Current Balancing between Phases
- Accurate Phasing Between Phases that Are Always  $180^{\circ}$  Out of Phase
- 100 kHz To 800 kHz Switching Frequency Per Phase
- High Voltage Internal 5V LDO for Single Supply Operation
- Secondary LDO To Improve System Efficiency
- Supports Start Up To Pre-bias Output
- Remote Sense Amplifier for Tight Output Regulation
- Supports Adaptive Voltage Positioning (AVP) or Droop

# MIC2133 Evaluation Board User's Guide

- Precision Enable Function for Low Stand-by Current
- External Programmable Soft Start to Reduce Inrush Current
- Programmable Current Limit and Hiccup Short Circuit Protection
- Thermal Shut Down With Hysteresis
- Die Temperature Sense
- Compact size: 5 x 5 mm 32-pin VQFN package
- -40°C to +125°C Junction Temperature Range

## 1.4 MIC2133 EVALUATION BOARD (EV66P64A) KIT CONTENTS

The MIC2133 Evaluation Board (EV66P64A) kit includes:

- MIC2133 Evaluation Board (EV66P64A)
- Important Information Sheet

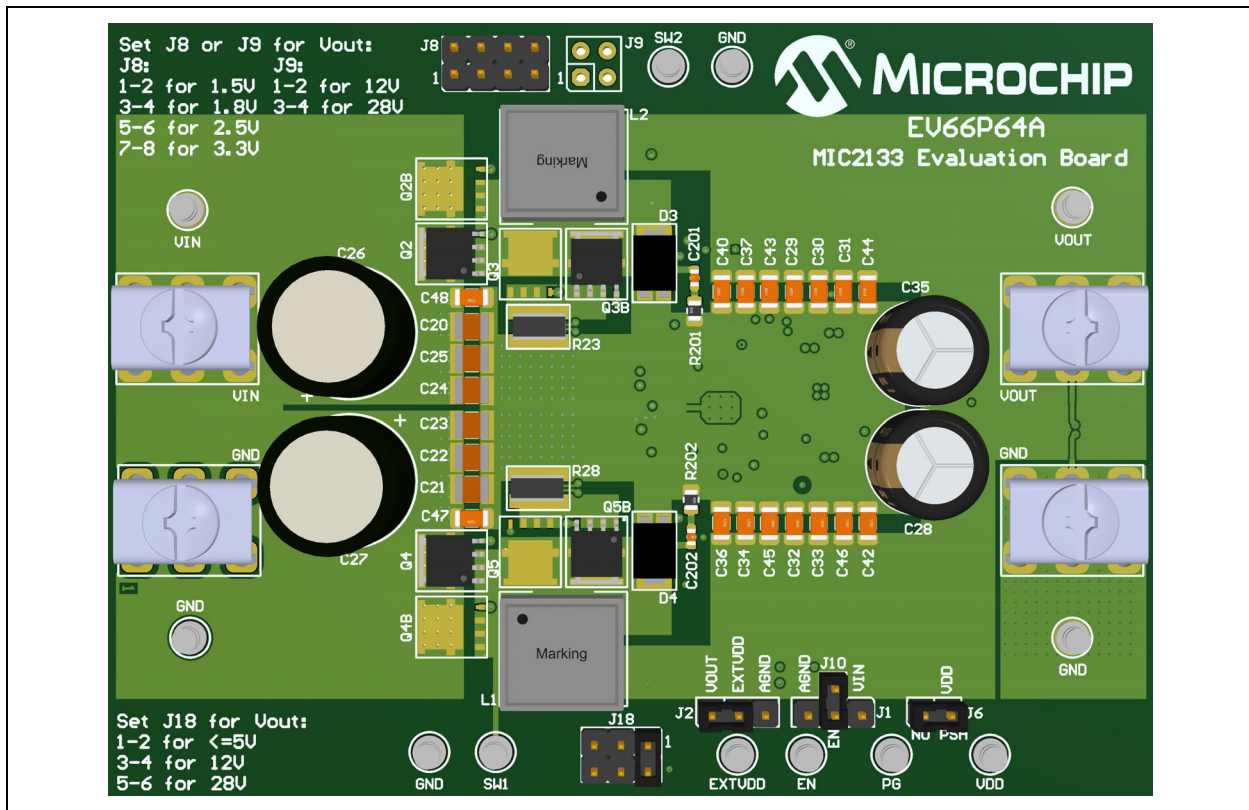
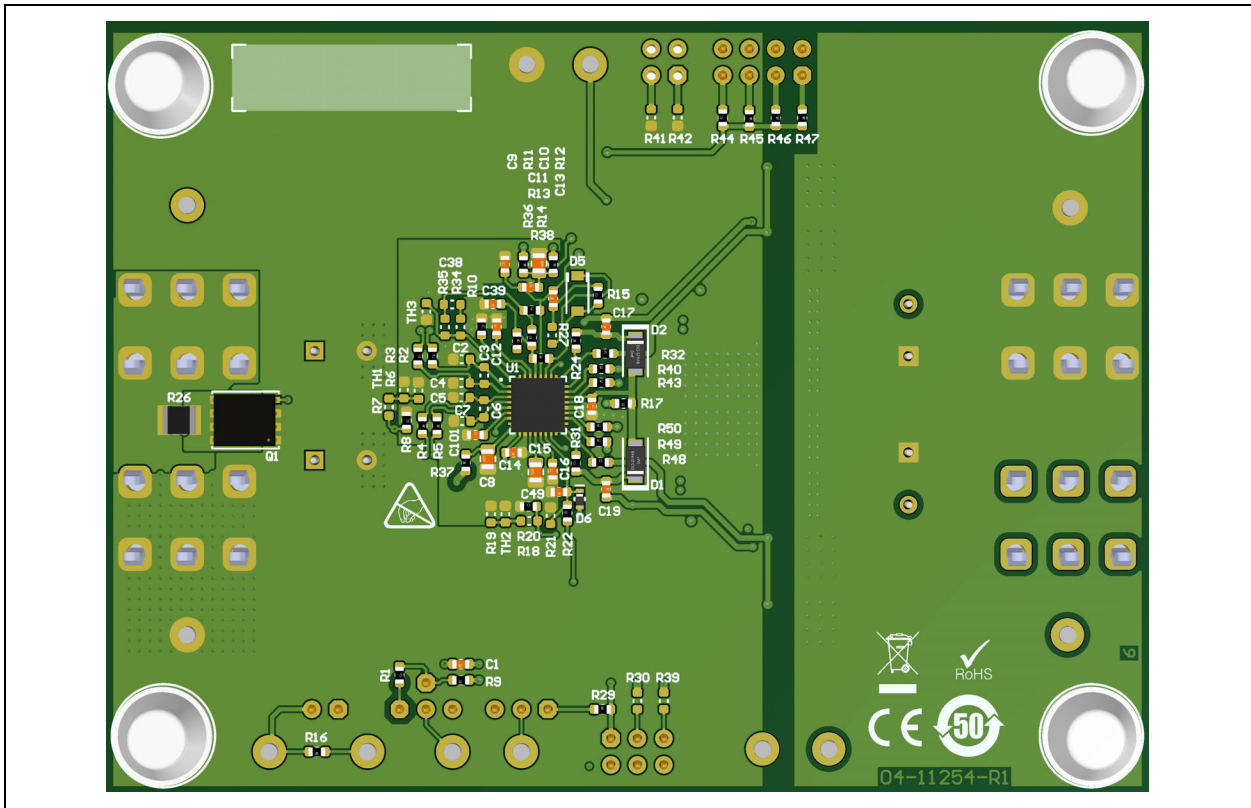

FIGURE 1-1: Typical MIC2133 Evaluation Board (EV66P64A) Top.



**FIGURE 1-2:** Typical MIC2133 Evaluation Board (EV66P64A) Bottom.

# MIC2133 Evaluation Board User's Guide

---

NOTES:

## Chapter 2. Installation and Operation

### 2.1 INTRODUCTION

The MIC2133 Evaluation Board (EV66P64A) is fully assembled and tested to evaluate and demonstrate the MIC2133 capabilities. The board is based on a buck topology and can deliver an adjustable output voltage between 1.5V and 5V, with a maximum current of 50A when is supplied with 10-75V at the input. It should be noted, however, that the board is tuned and optimized for a 5V/15A output.

#### 2.1.1 Powering the MIC2133 Evaluation Board

The board's power supply requires an output capability of at least 1A and a voltage range of 10 to 75V, at a minimum of 100W. A proper resistor or an electronic load device capable to sustain output voltage and current can be used as a load (see [Figure 2-1](#)).

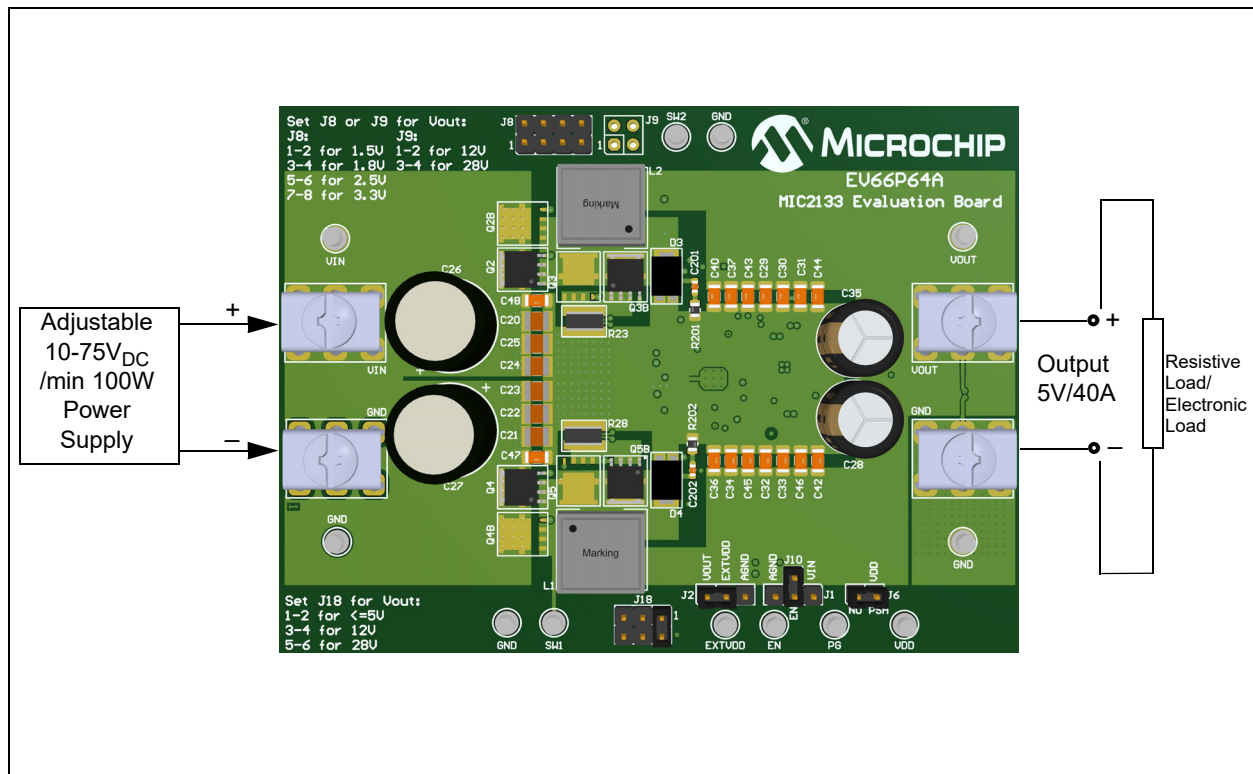

**FIGURE 2-1:** MIC2133 Evaluation Board (EV66P64A) Connection Diagram.

# MIC2133 Evaluation Board User's Guide

## 2.2 SETUP AND CONFIGURATION

### 2.2.1 IC

To enable IC, a jumper should be placed vertically on J10, (between the J10-1 and J1-2 connectors, as in [Figure 2-1](#)).

### 2.2.2 LDO

To use the internal high voltage LDO, a jumper should be placed on connectors J2-2 and J2-3 else.

To use an external power supply, the same jumper must be removed and an external voltage in the range of 4.7V to 13V should be supplied to the EXTVDD and AGND connectors.

To bypass the internal high voltage LDO, a jumper should be placed between the J2-1 (VOUT) and J2-2 (EXTVDD) connectors, if the output voltage is greater than 4.7V.

### 2.2.3 Voltage

The board's output voltage (either 1.5V, 1.8V, 2.5V, 3.3V, or 5V) is set by placing jumpers in the desired configuration. The selection for the desired output voltage can be made by plugging a jumper in the vertical position on the J8 connector (as in the table in the top left of the board) and a jumper must be placed vertically on the J18 connector, on its first right hand position.

**Note:** With no jumper on the J8 connector, the default output voltage is 5V.

#### EXAMPLE 2-1: CALCULATION OF $R_{ILIM}$ FOR BOTTOM MOSFET $R_{DSON}$ CURRENT SENSING

$$I_{LIM} = \frac{0.3V - (0.25 \cdot V_{ILIM})}{R_{DSON}} \quad (1)$$
$$V_{ILIM} = 1.2V - (4 \cdot R_{DSON} \cdot I_{LIM}) \quad (2)$$

For  $I_{LIM} = 15A$  per phase,  $R_{DSON} = 10m\Omega$  at  $25^{\circ}C$ , using equation (2)  $V_{ILIM} = 1.2V - 4 * 10m\Omega * 15A$ .

$V_{ILIM} = 0.6V$ , to get on  $I_{LIM}$  pin at  $10 \mu A$  constant over temperature current we need a programming equivalent resistor of  $R_{ILIM} = 0.6V/10 \mu A = 60 k\Omega$ .

#### EXAMPLE 2-2: CALCULATION OF THE FEEDBACK DIVIDER FOR 5V

$$R_{FB(BOT)} = \frac{R_{FB(TOP)}}{\frac{V_{OUT}}{V_{REF}} - 1} \quad (3)$$

For  $V_{OUT} = 5V$  with  $R_{FB(TOP)} = 22 k\Omega$  and  $V_{REF} = 0.6 V$ , using equation (3)  $R_{FB(BOT)} = 22 k\Omega / (5V/0.6V - 1)$  which results in  $R_{FB(BOT)} = 3 k\Omega$ .

---

---

## **Appendix A. Schematic and Layouts**

---

---

### **A.1 INTRODUCTION**

This appendix contains the following schematic and layouts of the MIC2133 Evaluation Board:

- [EV66P64A Board – Schematic](#)
- [EV66P64A Board – Top Silk](#)
- [EV66P64A Board – Top Copper and Silk](#)
- [EV66P64A Board – Top Copper](#)
- [EV66P64A Board – Inner 1 Copper](#)
- [EV66P64A Board – Inner 2 Copper](#)
- [EV66P64A Board – Inner 3 Copper](#)
- [EV66P64A Board – Inner 4 Copper](#)
- [EV66P64A Board – Bottom Silk](#)
- [EV66P64A Board – Bottom Copper and Silk](#)
- [EV66P64A Board – Bottom Copper](#)

# A.2 EV66P64A BOARD – SCHEMATIC

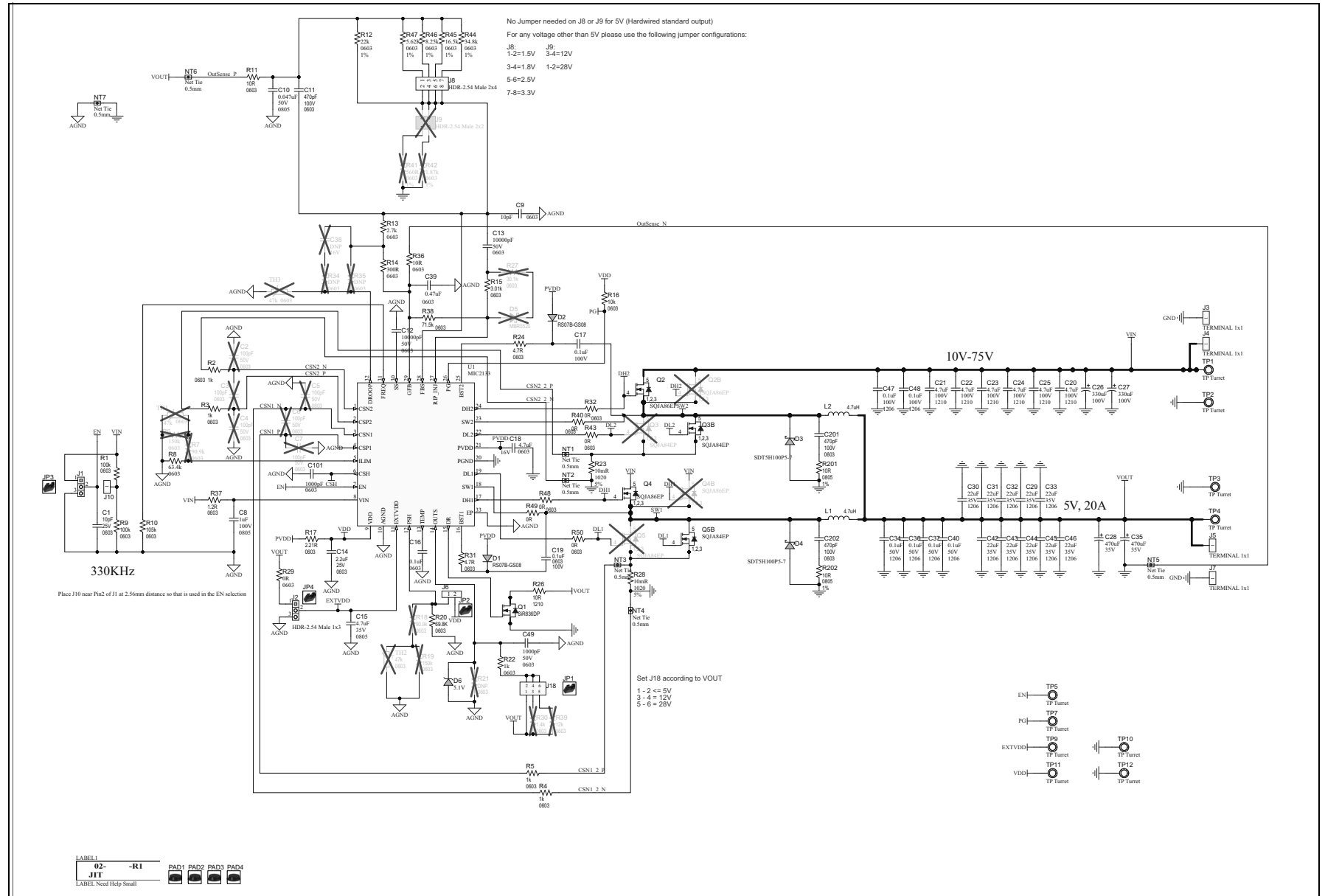



## A.3 EV66P64A BOARD – TOP SILK

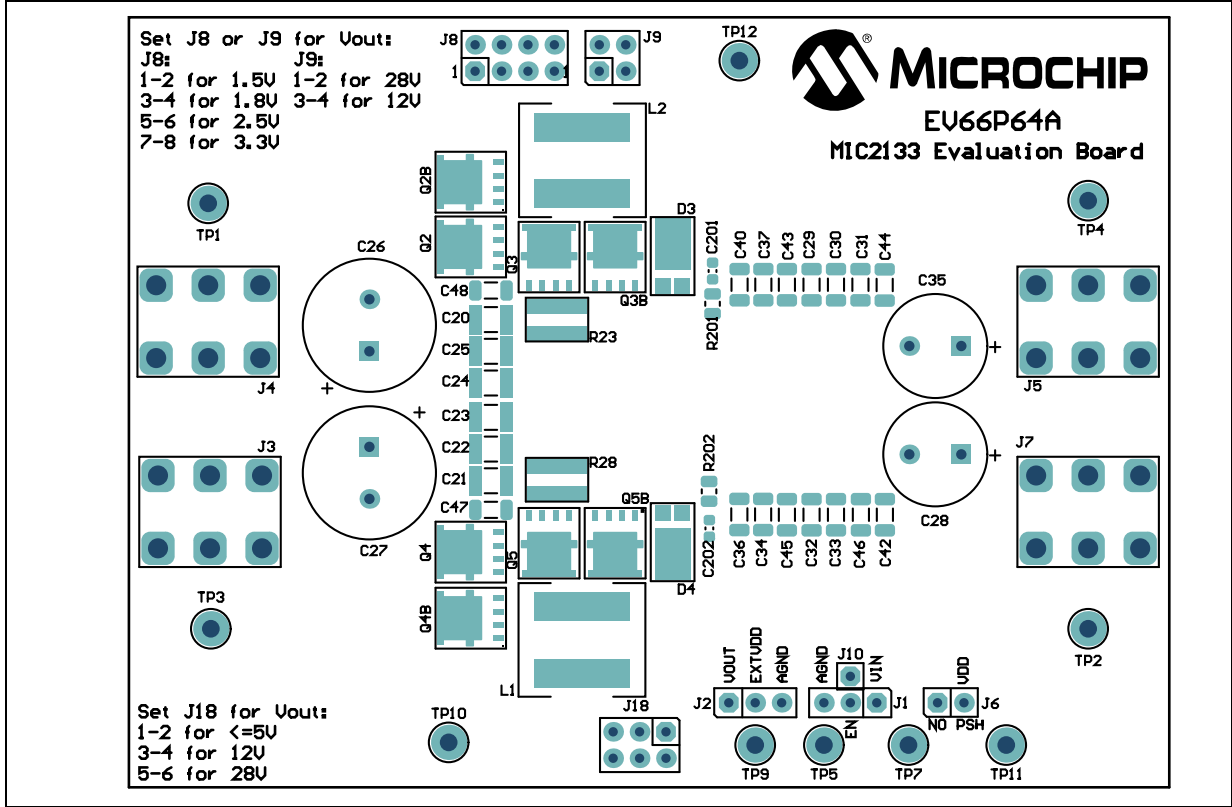

## A.4 EV66P64A BOARD – TOP COPPER AND SILK

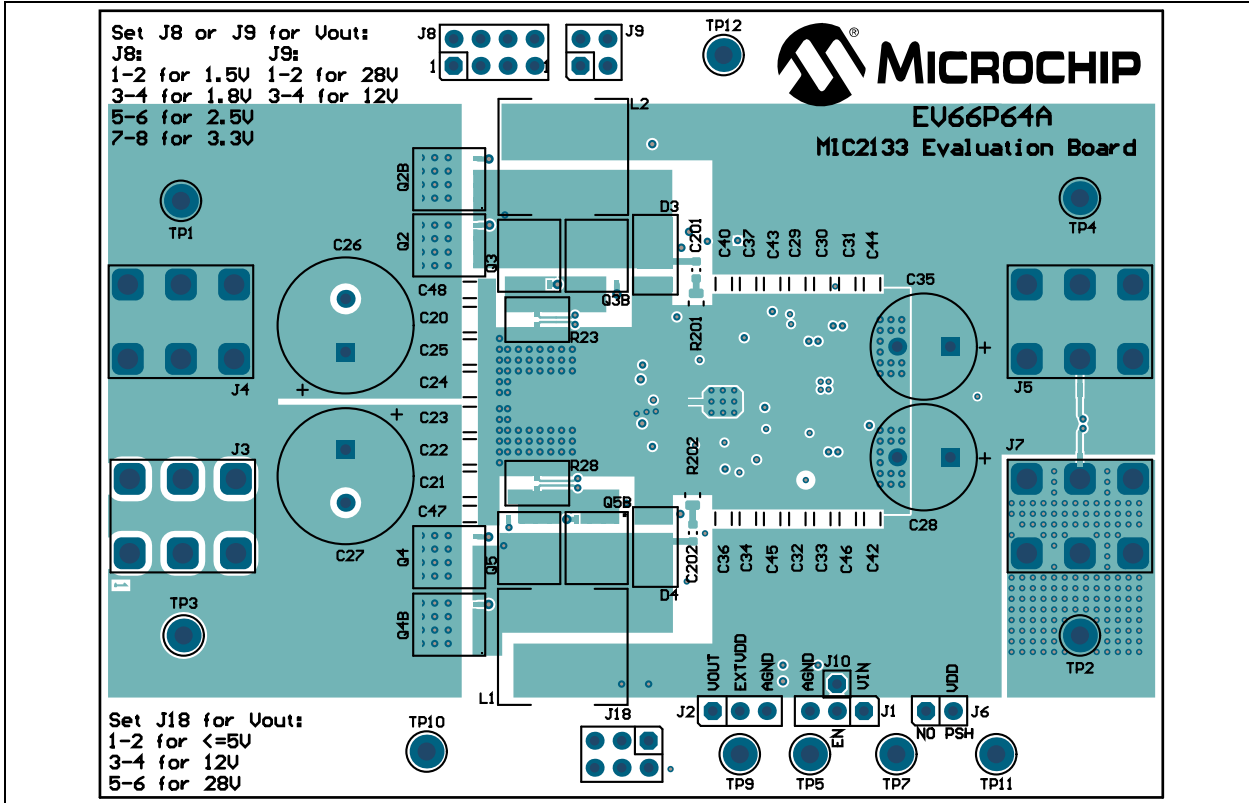

# MIC2133 Evaluation Board User's Guide

## A.5 EV66P64A BOARD – TOP COPPER

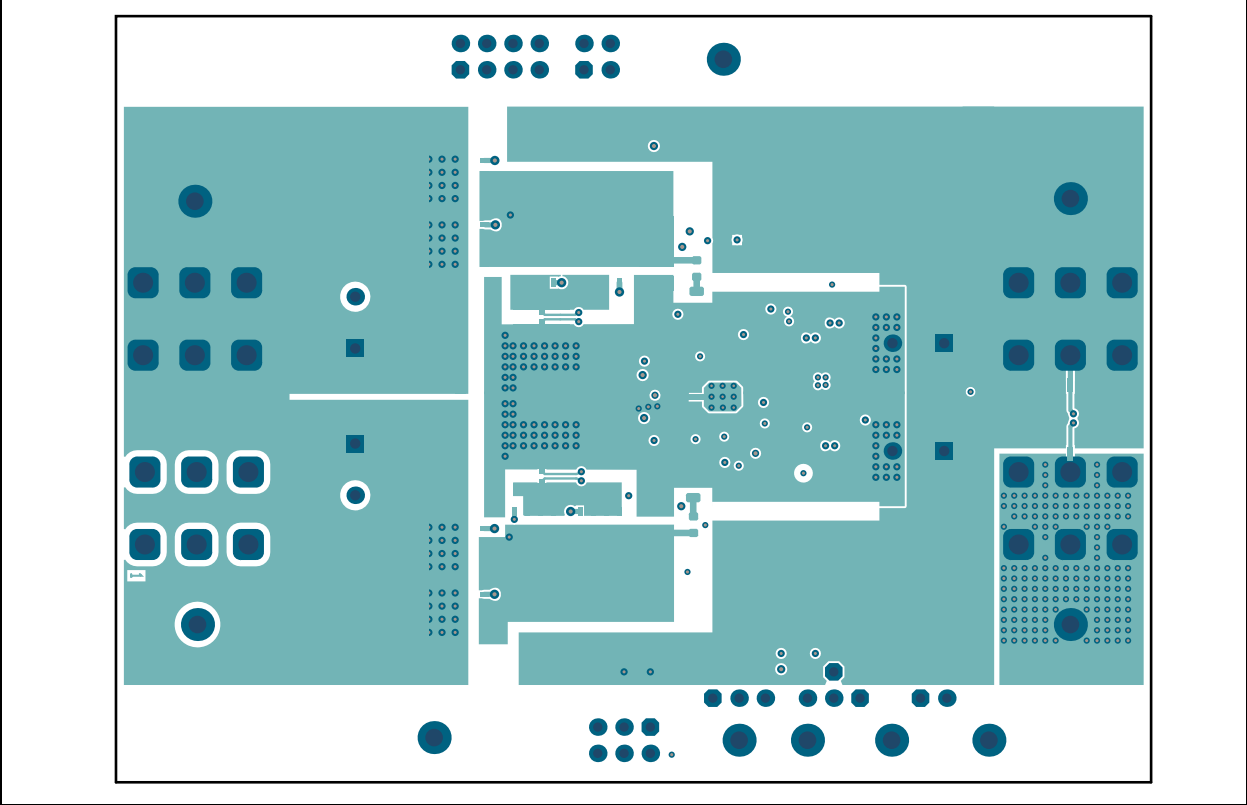

## A.6 EV66P64A BOARD – INNER 1 COPPER

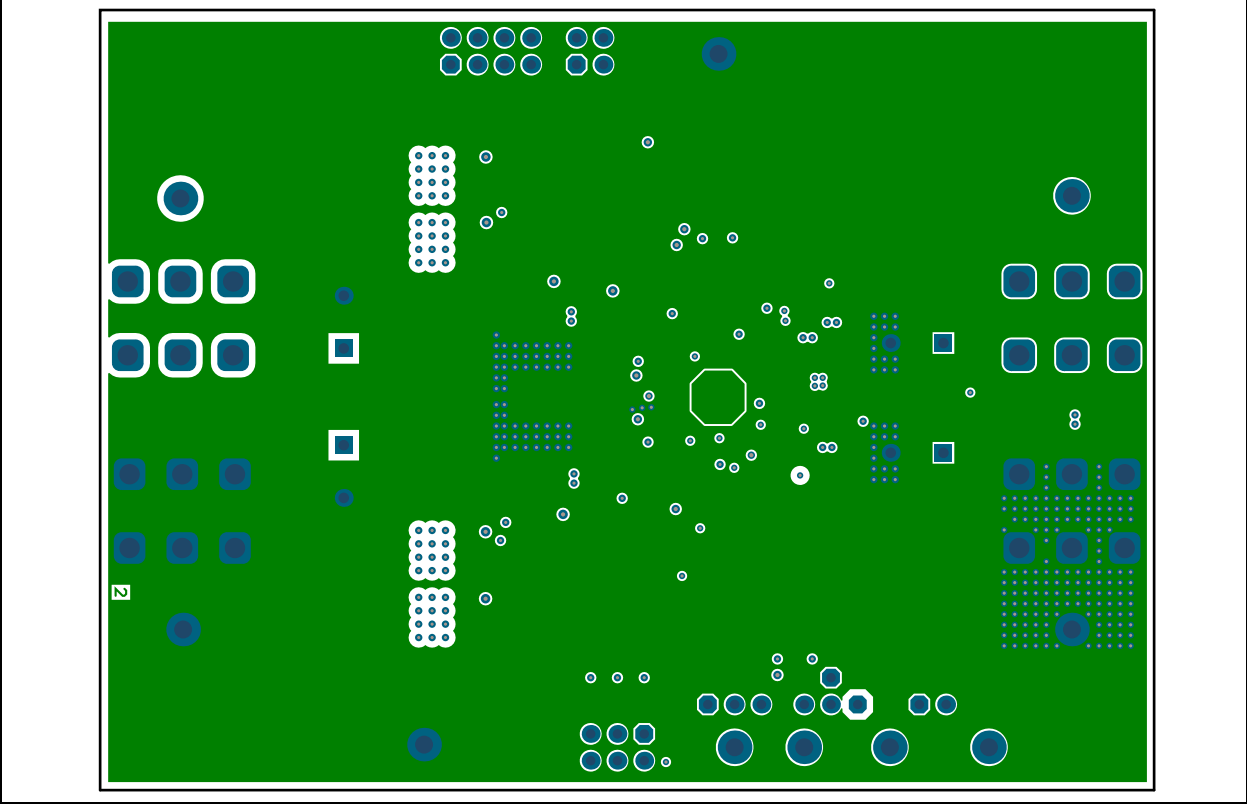

## A.7 EV66P64A BOARD – INNER 2 COPPER

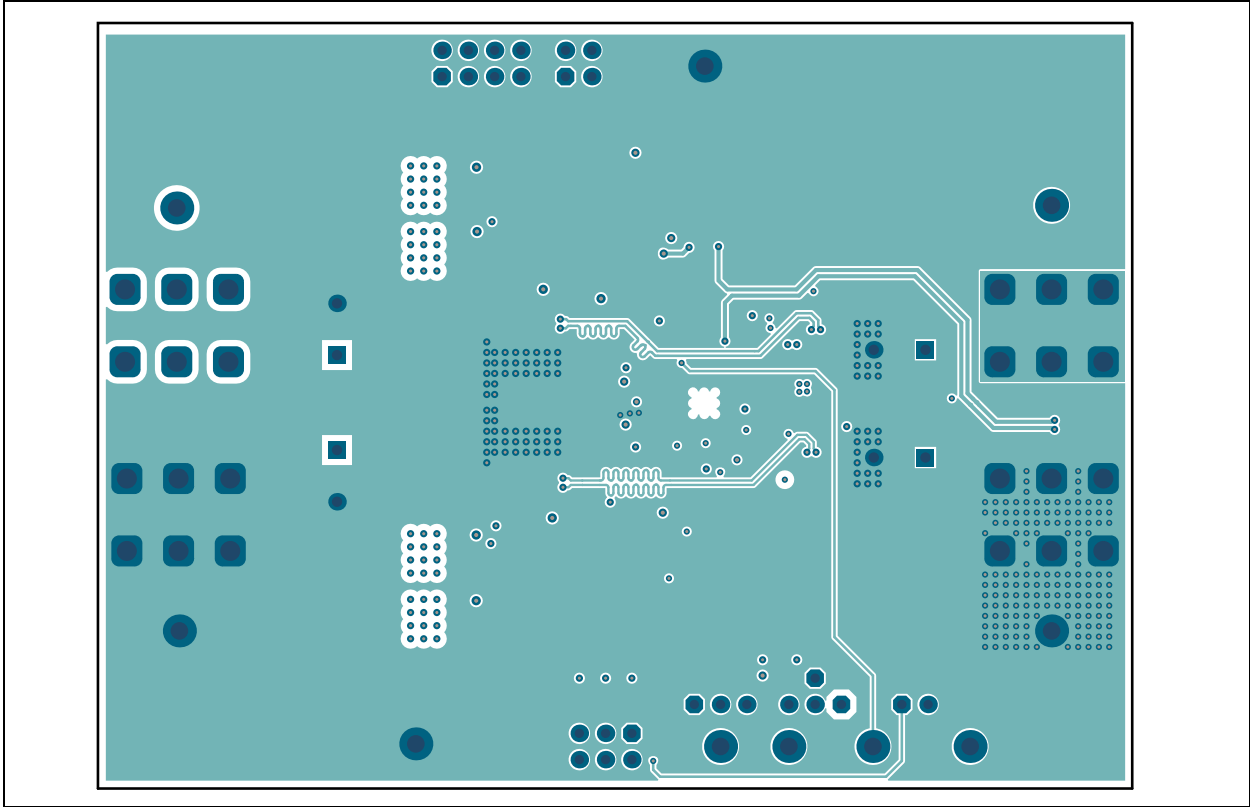

## A.8 EV66P64A BOARD – INNER 3 COPPER

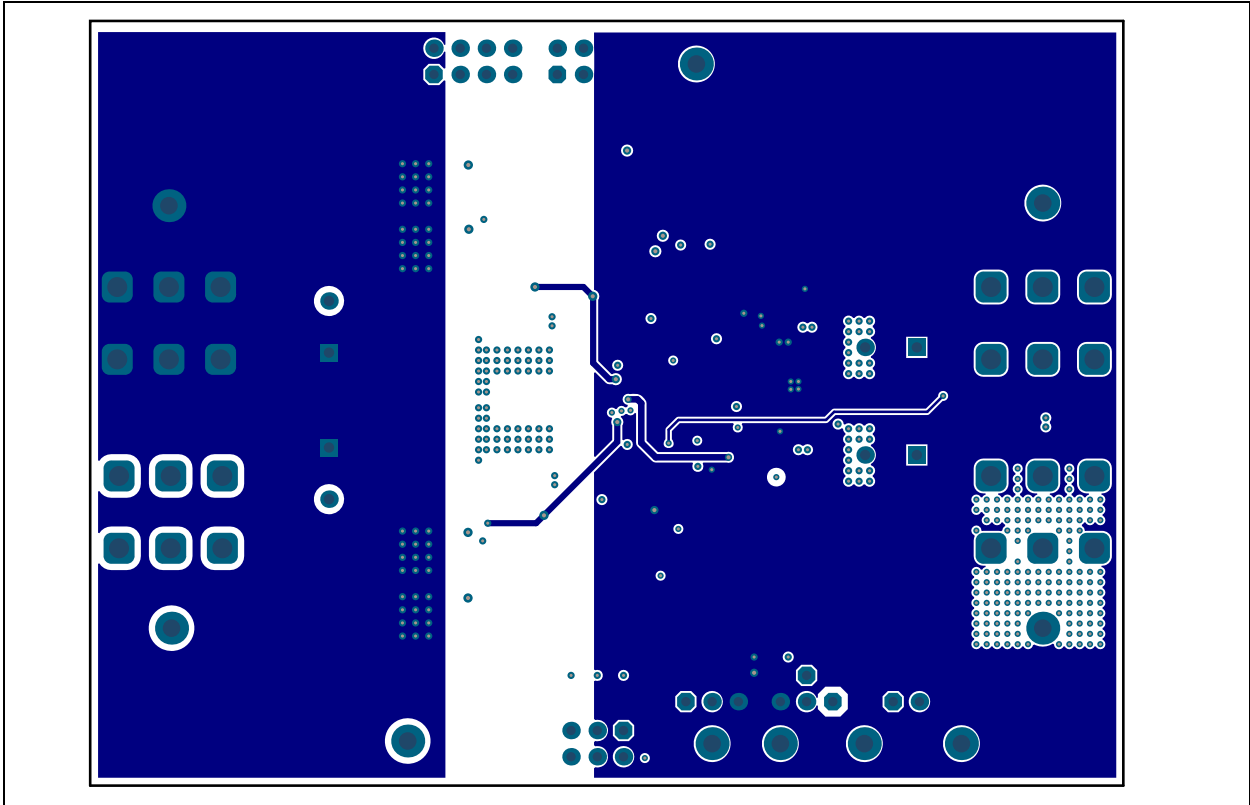

# MIC2133 Evaluation Board User's Guide

## A.9 EV66P64A BOARD – INNER 4 COPPER

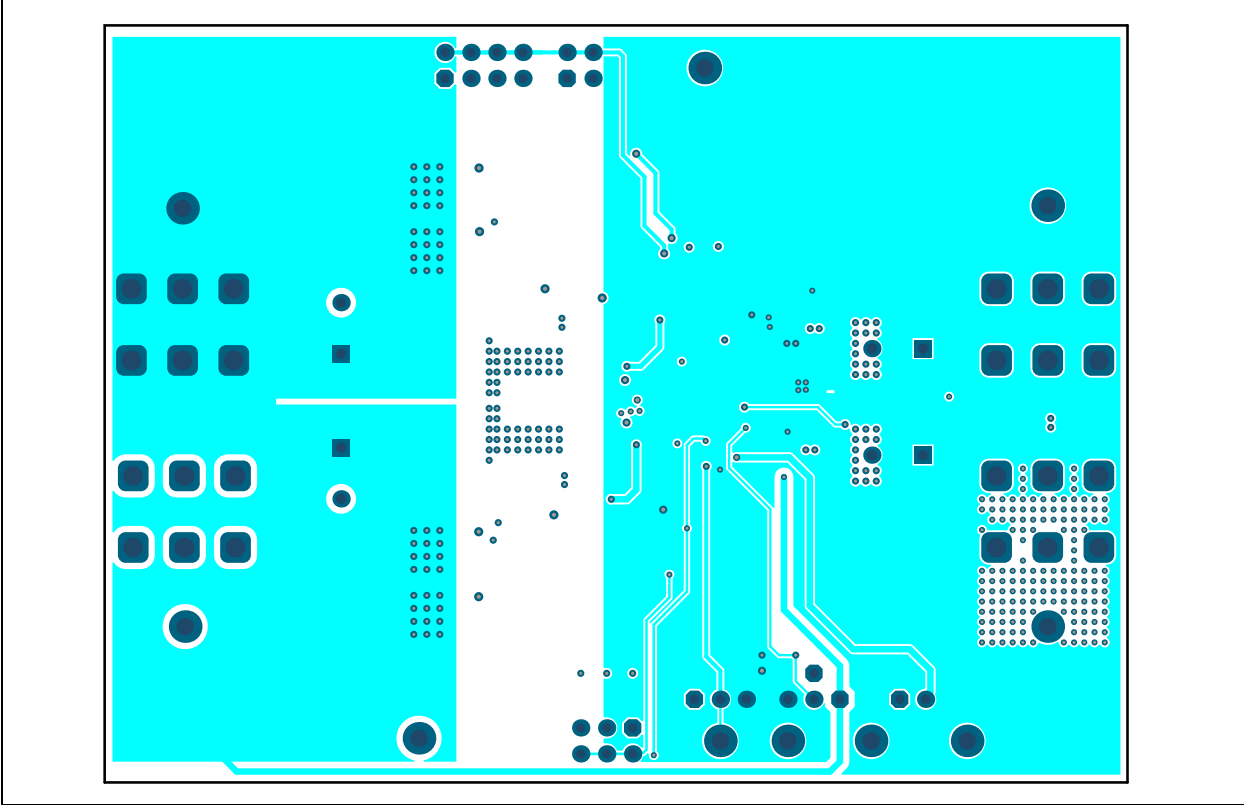

## A.10 EV66P64A BOARD – BOTTOM SILK

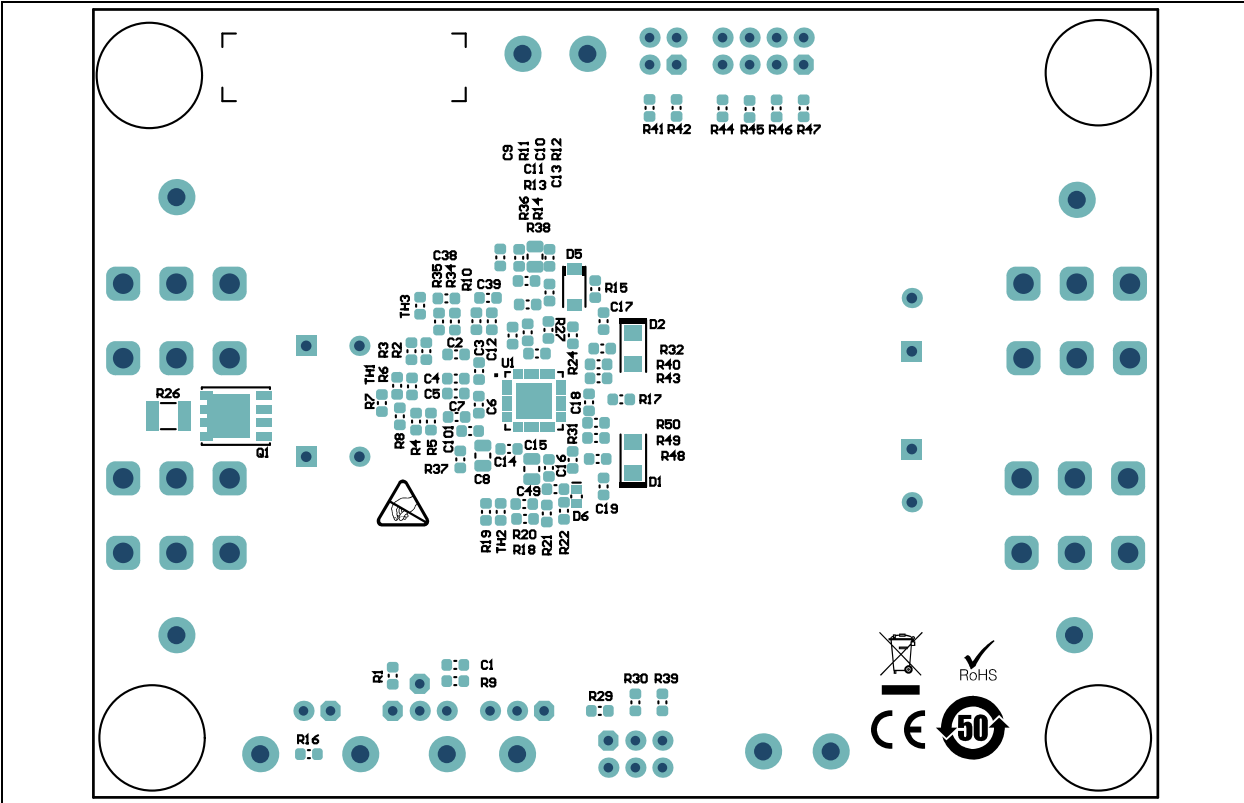

## A.11 EV66P64A BOARD – BOTTOM COPPER AND SILK

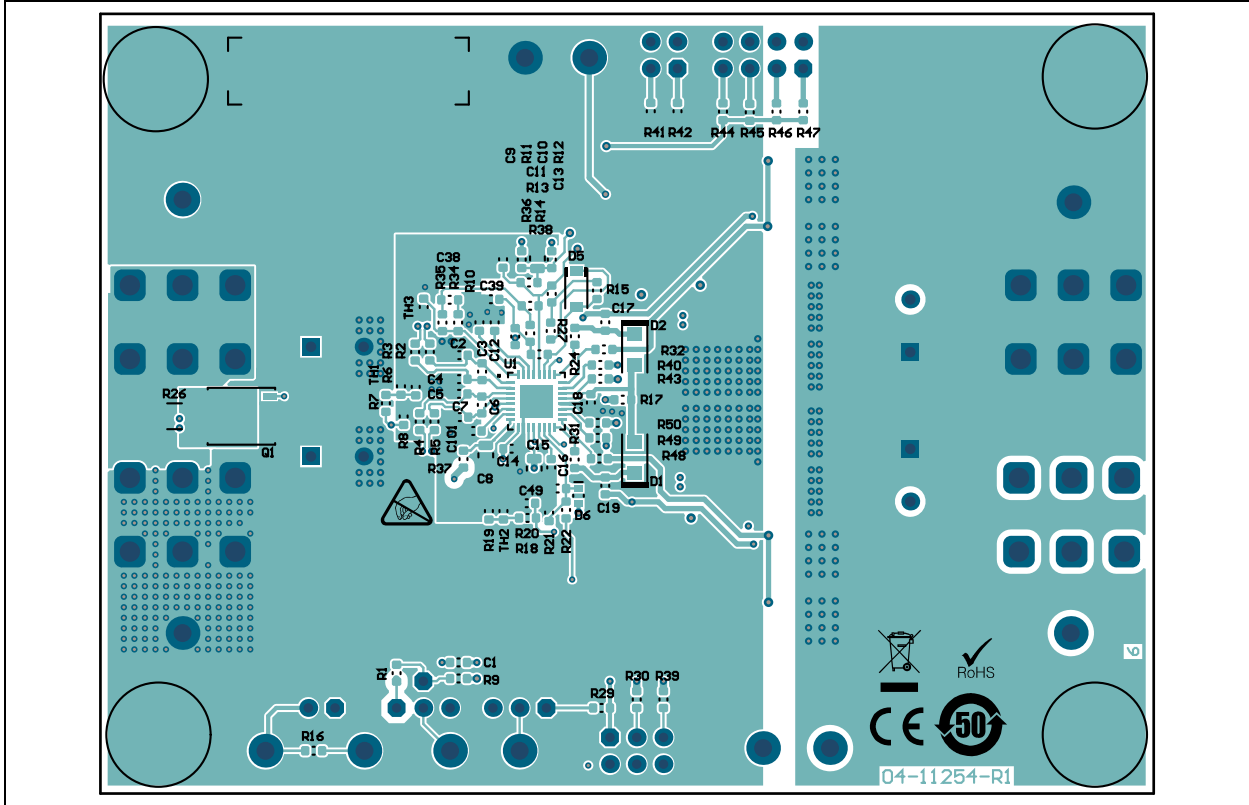

## A.12 EV66P64A BOARD – BOTTOM COPPER

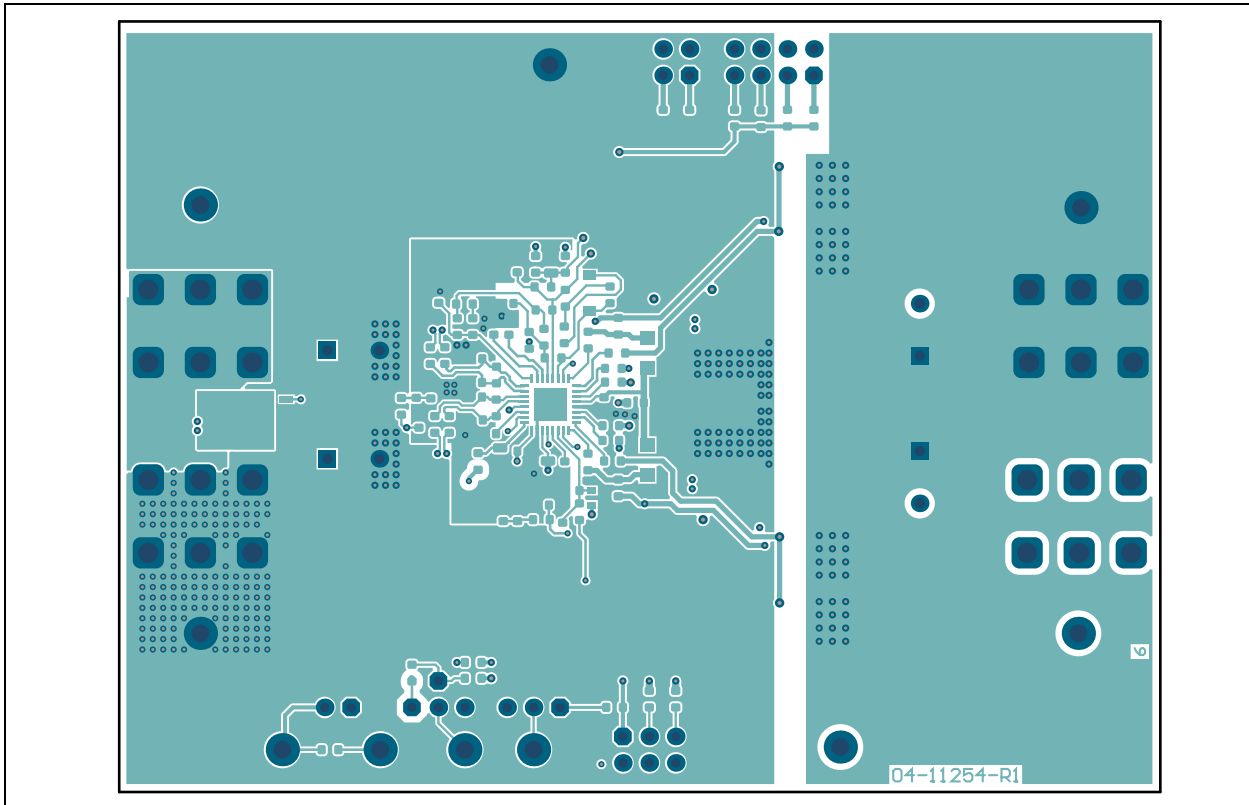

# MIC2133 Evaluation Board User's Guide

---

NOTES:

**Appendix B. Bill of Materials (BOM)**

**TABLE B-1: BILL OF MATERIALS (BOM)**

Qty.	Reference	Description	Manufacturer	Part Number
1	C1	Ceramic, capacitor, 10pF, 25V, 10%, NPO, SMD, 0603	Kyocera AVX	06033A100KAT2A
1	C8	Ceramic, capacitor, 1uF, 100V, 10%, X7S, SMD, 0805	TDK Corporation	C2012X7S2A105K125AB
1	C9	Ceramic, capacitor, 10pF, 50V, 0.5pF, C0G, SMD, 0603	TDK Corporation	C1608C0G1H100D080AA
1	C10	Ceramic, capacitor, 0.047uF, 50V, 20%, Y5V, SMD, 0805	Kyocera AVX	08055G473ZAT2A
3	C11, C201, C202	Ceramic, capacitor, 470pF, 100V, 5%, C0G, SMD, 0603	TDK Corporation	CGA3E2C0G2A471J080AA
2	C12, C13	Ceramic, capacitor, 10000pF, 50V, 10%, X7R, SMD, 0603	KEMET	C0603C103K5RACTU
1	C14	Ceramic, capacitor, 2.2uF, 25V, 10%, X5R, SMD, 0603	Murata Electronics®	GRM188R61E225KA12D
1	C15	Ceramic, capacitor, 4.7uF, 35V, 10%, X7R, SMD, 0805	TDK Corporation	C2012X7R1V475K125AE
1	C16	Ceramic, capacitor, 0.1uF, 16V, 10%, X7R, SMD, 0603,	Taiyo Yuden Co., Ltd.	EMK107B7104KA
2	C17, C19	Ceramic, capacitor, 0.1uF, 100V, 10%, X7R, SMD, 0603	Murata Electronics	GRM188R72A104KA35D
1	C18	Ceramic, capacitor, 4.7uF, 16V, 10%, X5R, SMD, 0603	TDK Corporation	C1608X5R1C475K080AC
6	C20, C21, C22, C23, C24, C25	Ceramic, capacitor, 4.7uF, 100V, 10%, X7S, SMD, 1210, AEC-Q200	Taiyo Yuden Co., Ltd.	HMK325C7475KMHPE
2	C26, C27	Capacitor, aluminum, 330uF, 100V, 20%, RAD, P5D12.5H25	Nichicon Corporation	UFW2A331MHD
2	C28, C35	Capacitor, aluminum, 470uF 35V 20% RAD P5D10H20	United Chemi-Con	EKZE350ELL471MJ20S
10	C29, C30, C31, C32, C33, C42, C43, C44, C45, C46	Ceramic, capacitor, 22uF, 35V, 20%, X5R, SMD, 1206	TDK Corporation	C3216X5R1V226M160AC
4	C34, C36, C37, C40	Ceramic, capacitor, 0.1uF, 50V, 10%, X7R, SMD, 1206	Yageo Corporation	CC1206KRX7R9BB104
1	C39	Ceramic, capacitor, 0.47uF, 25V, 10%, X7R, SMD, 0603	Murata Electronics	GRM188R71E474KA12D
2	C47, C48	Ceramic, capacitor, 0.1uF, 100V, 10%, X7R, SMD, 1206	Yageo Corporation	CC1206KKX7R0BB104
2	C49, C101	Ceramic, capacitor, 1000pF, 50V, 10%, X7R, SMD, 0603	Würth Elektronik	885012206083

**Note 1:** The components listed in this Bill of Materials are representative of the PCB assembly. The released BOM used in manufacturing uses all RoHS-compliant components.

# MIC2133 Evaluation Board User's Guide

**TABLE B-1: BILL OF MATERIALS (BOM) (CONTINUED)**

Qty.	Reference	Description	Manufacturer	Part Number
2	D1, D2	Diode, rectifier, RS07B-GS08, 100V, 500mA, SMD, DO-219AB	Vishay Semiconductors	RS07B-GS08
2	D3, D4	Diode, Schottky, RS07B-GS08, 100V, 5A, SMD, Power DI-5	Diodes Incorporated®	SDT5H100P5-7
1	D6	Diode, Zener, DZ2705100L 5.1V, 120mW, SMD, SOD-523	Panasonic - SSG	DZ2705100L
2	J1, J2	Connector, header-2.54, male, 1x3, Gold, 5.84MH, TH, vertical	Amphenol ICC	68000-103HLF
4	J3, J4, J5, J7	Connector, terminal, 30A, female, 1x1, TH, vertical	Keystone® Electronics Corp.	8197
1	J6	Connector, header-2.54, male, 1x2, Gold, 5.84MH, TH, vertical	Amphenol ICC (FCI)	77311-118-02LF
1	J8	Connector, header-2.54, male, 2x4, Gold, 5.84MH, TH, vertical	Wurth Elektronik	61300821121
1	J10	Connector, header-2.54, male, 1x1, Gold, 5.84MH, TH, vertical	Samtec, Inc.	TSW-101-07-S-S
1	J18	Connector, header-2.54, male, 2x3, Gold, 5.84MH, TH, vertical	Samtec, Inc.	TSW-103-08-L-D
2	L1, L2	Inductor, 4.7uH, 27A, 20%, SMD, L11.6W10.5H8.8	Wurth Elektronik	74439369047
1	Q1	Transistor, FET, N-Ch, SiR836DP, 40V, 21A, 15.6W, PPAK, SO-8	Vishay Siliconix	SIR836DP-T1-GE3
2	Q2, Q4	Transistor, FET, N-Ch, SQJA86EP, 80V, 30A, Power-PAK, SO-8, LAEC-Q101	Vishay Siliconix	SQJA86EP-T1_GE3
2	Q3B, Q5B	Transistor, FET, N-Ch, SQJA84EP, 80V, 46A, Power-PAK, SO-8, LAEC-Q101	Vishay Siliconix	SQJA84EP-T1_GE3
2	R1, R9,	Resistor, TF, 100k, 1%, 1/8W, SMD, 0603	Vishay Beyschlag	MCT06030C1003FP500
4	R2, R3, R4, R5	Resistor, TF, 1k, 0.1%, 1/10W, SMD, 0603	Panasonic® - ECG	ERA-3AEB102V
1	R8	Resistor, TKF, 63.4k, 1%, 1/10W, SMD, 0603, AEC-Q200	Panasonic - ECG	ERJ-3EKF6342V
1	R10	Resistor, TKF, 105k, 1%, 1/16W, SMD, 0603	Panasonic - ECG	ERJ-3EKF1053V
2	R11, R36	Resistor, TKF, 10R, 1%, 1/10W, SMD, 0603	Panasonic - ECG	ERJ3EKF10R0V
1	R12	Resistor, TKF, 22k, 1%, 1/10W, SMD, 0603	SEI	RMCF0603FT22K0
1	R13	Resistor, TKF, 2.7k, 1%, 1/10W, SMD, 0603	Panasonic - ECG	ERJ-3EKF2701V
1	R14	Resistor, TKF, 300R, 1%, 1/10W, SMD, 0603	Yageo Corporation	R0603FR-07300RL
1	R15	Resistor, TKF, 3.01k, 1%, 1/10W, SMD, 0603	Panasonic - ECG	ERJ-3EKF3011V
1	R16	Resistor, TKF, 10k, 1%, 1/16W, SMD, 0603	Noehm Componenti S.r.l.	CPF0603F10KC1

**Note 1:** The components listed in this Bill of Materials are representative of the PCB assembly. The released BOM used in manufacturing uses all RoHS-compliant components.



# Bill of Materials (BOM)

**TABLE B-1: BILL OF MATERIALS (BOM) (CONTINUED)**

Qty.	Reference	Description	Manufacturer	Part Number
1	R17	Resistor, TF, 2.21R, 0.1%, 1/16W, SMD, 0603	Stackpole Electronics, Inc.	RNCF0603BKC2R21
1	R20	Resistor, TF, 69.8K, 0.1%, 1/10W, SMD, 0603	Panasonic - ECG	ERA-3AEB6982V
11	R22	Resistor, TKF, 1k, 1%, 1/10W, SMD, 0603 AEC-Q200	Panasonic - ECG	ERJ3EKF1001V
2	R23, R28	Resistor, TKF, 10mR, 5%, 2W, SMD, 1020 AEC-Q200	Vishay/Dale	RCWE102010L0JNEA
2	R24, R31	Resistor, TKF, 4.7R 1% 1/10W SMD 0603	Panasonic - ECG	ERJ-3RQF4R7V
1	R26	Resistor, TKF, 10R, 1%, 1/2W, SMD, 1210	Stackpole Electronics, Inc.	RMCF1210FT10R0
7	R29, R32, R40, R43, R48, R49, R50	Resistor, TKF, 0R, 1/10W, SMD, 0603	Panasonic - ECG	ERJ-3GEY0R00V
1	R37	Resistor, TKF, 1.2R, 1%, 1/10W, AEC-Q200, SMD 0603	Panasonic - ECG	ERJ-3RQF1R2V
1	R38	Resistor, TKF, 71.5k, 1%, 1/10W, SMD, 0603	Panasonic - ECG	ERJ-3EKF7152V
1	R44	Resistor, TKF, 34.8k, 1%, 1/10W, SMD, 0603	Panasonic - ECG	ERJ-3EKF3482V
1	R45	Resistor, TKF, 16.5k, 1%, 1/10W, SMD, 0603, AEC-Q200	Panasonic - ECG	ERJ3EKF1652V
1	R46	Resistor, TKF, 8.25k, 1%, 1/10W, SMD, 0603	Panasonic - ECG	ERJ3EKF8251V
1	R47	Resistor, TKF, 5.62k, 1%, 1/10W, SMD, 0603	Panasonic - ECG	ERJ-3EKF5621V
2	R201, R202	Resistor, TKF, 10R, 1%, 1/8W, SMD, 0805	Vishay/Dale	CRCW080510R0FKEAC
12	TP1, TP2, TP3, TP4, TP5, TP6, TP7, TP8, TP9, TP10, TP11, TP12	Connector, TP, Pin, Tin, TH	Harwin Plc.	H2121-01

**Note 1:** The components listed in this Bill of Materials are representative of the PCB assembly. The released BOM used in manufacturing uses all RoHS-compliant components.

**TABLE B-2: BILL OF MATERIALS (BOM) – MICROCHIP PARTS**

Qty.	Reference	Description	Manufacturer	Part Number
1	U1	Microchip Analog 75V Dual Phase COT Switching Buck Controller, MIC2133, QFN-32	Microchip Technology Inc.	MIC2132YML-TR

**Note 1:** The components listed in this Bill of Materials are representative of the PCB assembly. The released BOM used in manufacturing uses all RoHS-compliant components.

**TABLE B-3: BILL OF MATERIALS (BOM) – MECHANICAL PARTS**

Qty.	Reference	Description	Manufacturer	Part Number
4	JP1, JP2, JP3, JP4	Mechanical, hardware, jumper, 2.54mm, 1x2	3M	969102-0000-DA
4	PAD1, PAD2, PAD3, PAD4	Mechanical, hardware, rubber pad, cylindrical flat top, D8H2.8, black	3M	SJ5076BLACK

**Note 1:** The components listed in this Bill of Materials are representative of the PCB assembly. The released BOM used in manufacturing uses all RoHS-compliant components.

# MIC2133 Evaluation Board User's Guide

**TABLE B-4: BILL OF MATERIALS (BOM) – DO NOT POPULATE PARTS**

Qty.	Reference	Description	Manufacturer	Part Number
6	C2, C3, C4, C5, C6, C7	Capacitor, ceramic, 100pF, 50V, 10%, X7R, SMD, 0603	Vishay Vitramon	VJ0603Y101KXACW1BC
1	C38	Capacitor, ceramic, 1uF, 16V, 10%, X5R, SMD, 0603	Kyocera AVX	0603YD105KAT2A/4K
1	D5	Diode, Schottky, RS07B-GS08, 100V, 5A, SMD, MBR0520, 385mV, 500mA, 20V, SOD-123	ON Semiconductor	MBR0520L
1	J9	Connector, header-2.54, male, 2x2, Gold, 5.84MH, TH, verticalT	Samtec, Inc.	TSW-102-07-G-D
2	Q2B, Q4B	Transistor, FET, N-Ch, SQJA86EP, 80V, 30A, PowerPAK, SO-8L AEC-Q101	Vishay Siliconix	SQJA86EP-T1_GE3
2	Q3, Q5	Transistor, FET, N-Ch, SQJA84EP, 80V, 46A, PowerPAK, SO-8, L AEC-Q101	Vishay Siliconix	SQJA84EP-T1_GE3
2	R6, R19	Resistor, TKF, 150k, 1%, 1/8W, SMD, 0603	KOA Speer Electronics, Inc.	SG73S1JTDD1503F
2	R7, R18	Resistor, TKF, 90.9k, 1%, 1/10W, SMD, 0603	Panasonic - ECG	ERJ-3EKF9092V
1	R21	Resistor, TKF, 0R, 1/10W, SMD, 0603	Panasonic - ECG	ERJ-3GEY0R00V
1	R27	Resistor, TF, 30.1k, 0.1%, 1/10W, SMD, 0603	Susumu Co., Ltd.	RG1608P-3012-B-T5
1	R30	Resistor, TKF, 1.4k, 1%, 1/10W, SMD, 0603	Panasonic - ECG	ERJ-3EKF1401V
2	R34, R35	Resistor, TKF, 39k, 1%, 1/10W, SMD, 0603	Panasonic - ECG	ERJ-3EKF3902V
1	R39	Resistor, TKF, 12k, 1%, 1/10W, SMD, 0603	Stackpole Electronics, Inc.	RMCF0603FT12K0
1	R41	Resistor, TKF, 560R, 1%, 1/10W, SMD, 0603	Yageo Corporation	RC0603FR-07560RL
1	R42	Resistor, TKF, 1.87k, 1%, 1/10W, SMD, 0603	Panasonic - ECG	ERJ-3EKF1871V
3	TH1, TH2, TH3	Resistor, Thermistor, 47k, 1%, 100mW, SMD, 0603	Murata Electronics	NCU18WB473F60RB

**Note 1:** The components listed in this Bill of Materials are representative of the PCB assembly. The released BOM used in manufacturing uses all RoHS-compliant components.

## Appendix C. Board Performance Curves and Waveforms

### C.1 REFERENCE DESIGN PERFORMANCE

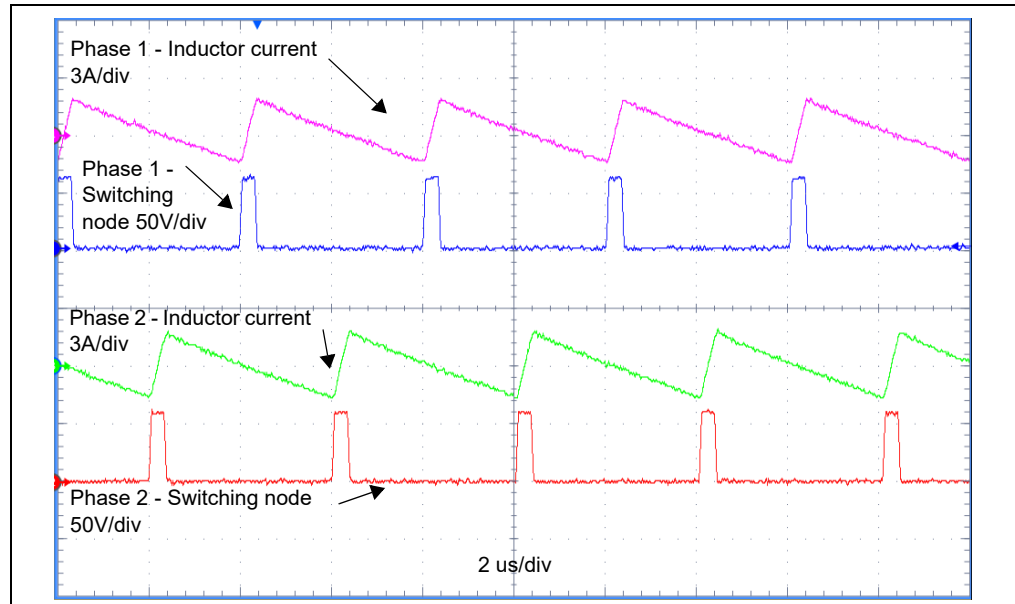

**FIGURE C-1:** Switching Node Waveforms for  $V_{IN}$  60V,  $V_{OUT}$  5V and No Load.

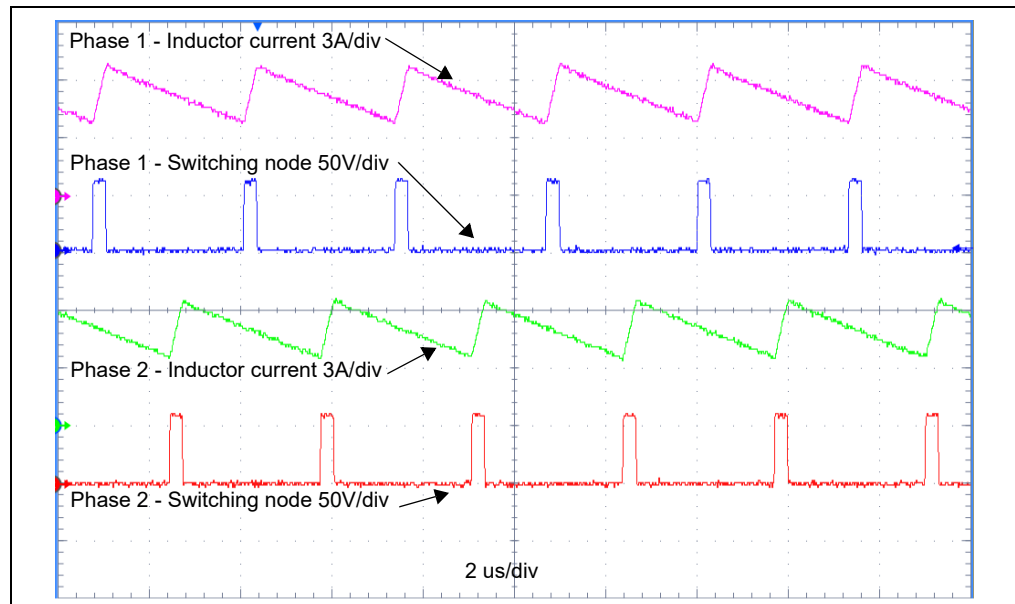

**FIGURE C-2:** Switching Node Waveforms for  $V_{IN}$  60v,  $V_{OUT}$  5v and Iout 10A.

# MIC2133 Evaluation Board User's Guide

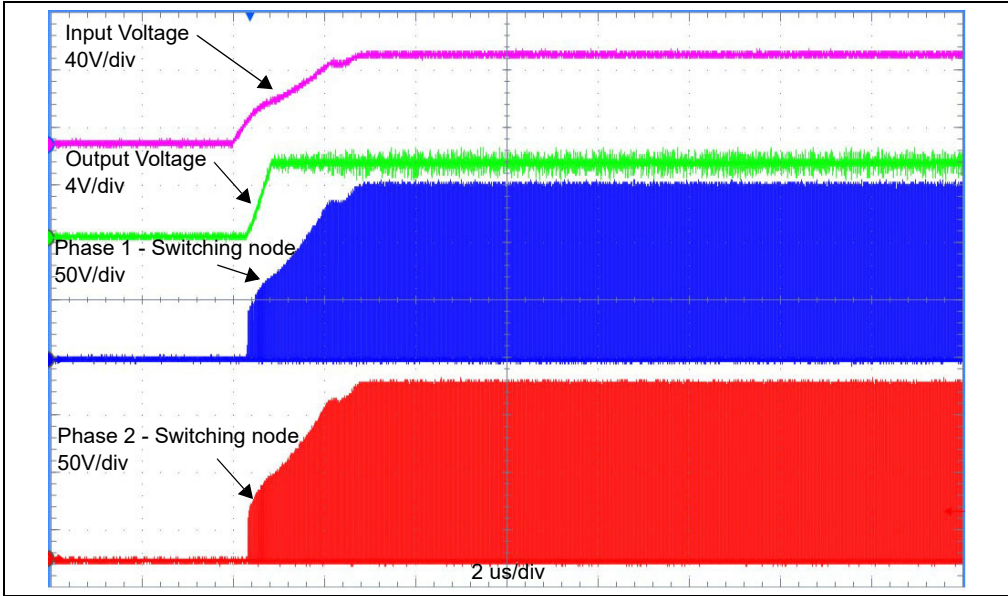

FIGURE C-3: Soft Start.

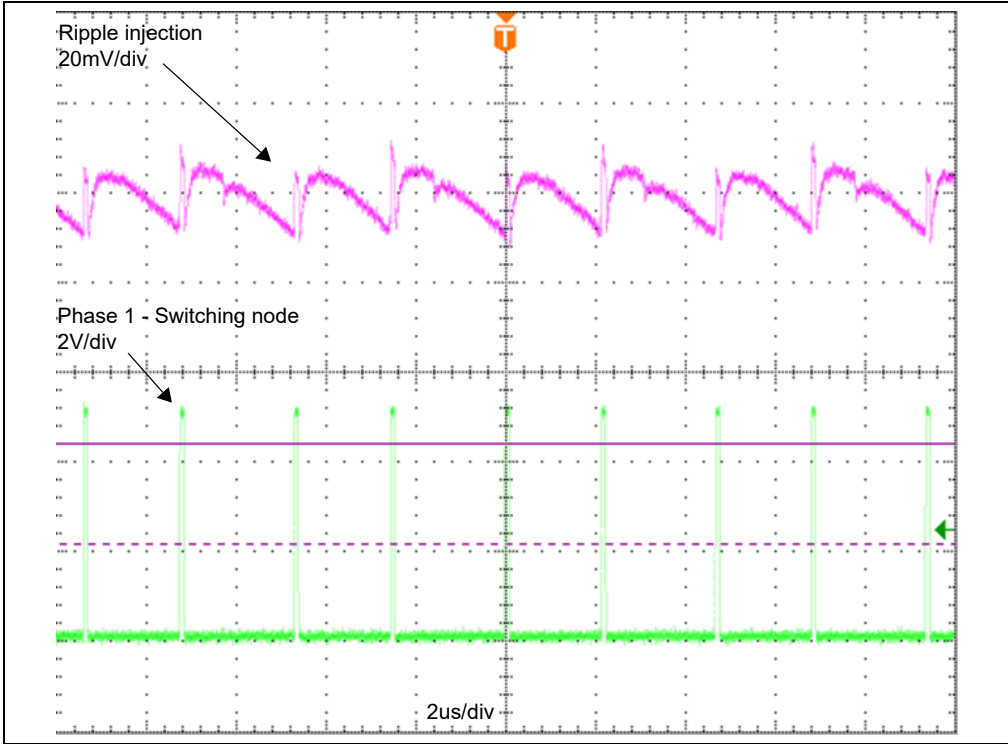
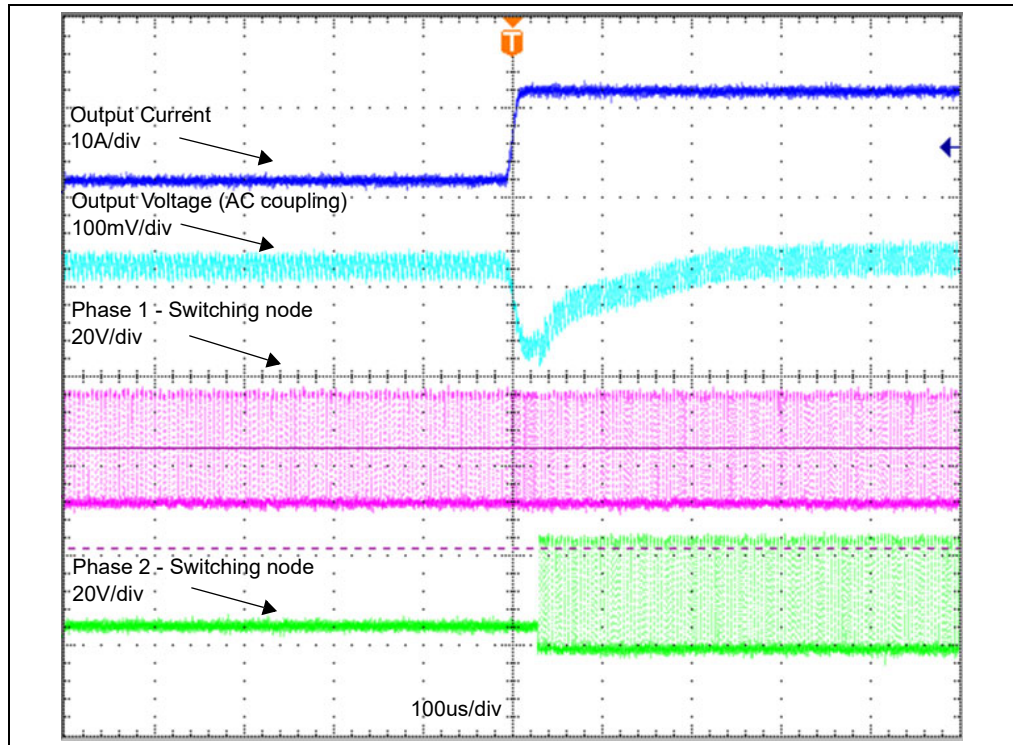
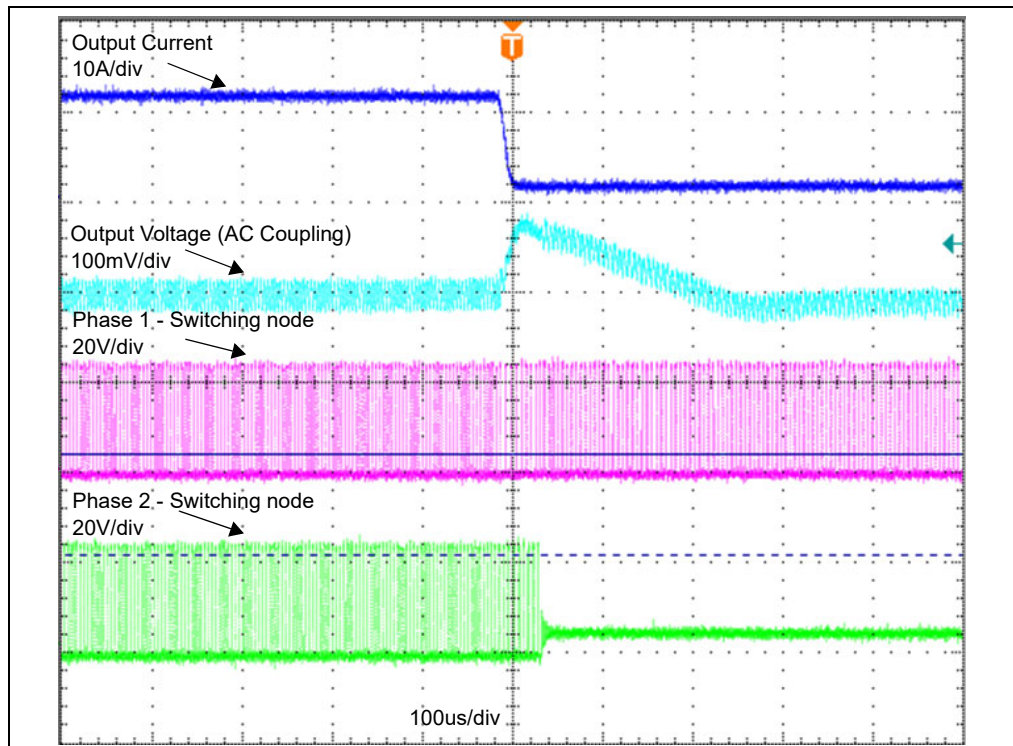

FIGURE C-4: Ripple Injection.

# Board Performance Curves and Waveforms



**FIGURE C-5:** Load Transient with PSH from 2A to 12A at 24V.



**FIGURE C-6:** Load Transient with PSH from 12A to 2A at 24V.

# MIC2133 Evaluation Board User's Guide

## C.2 PERFORMANCE CURVES

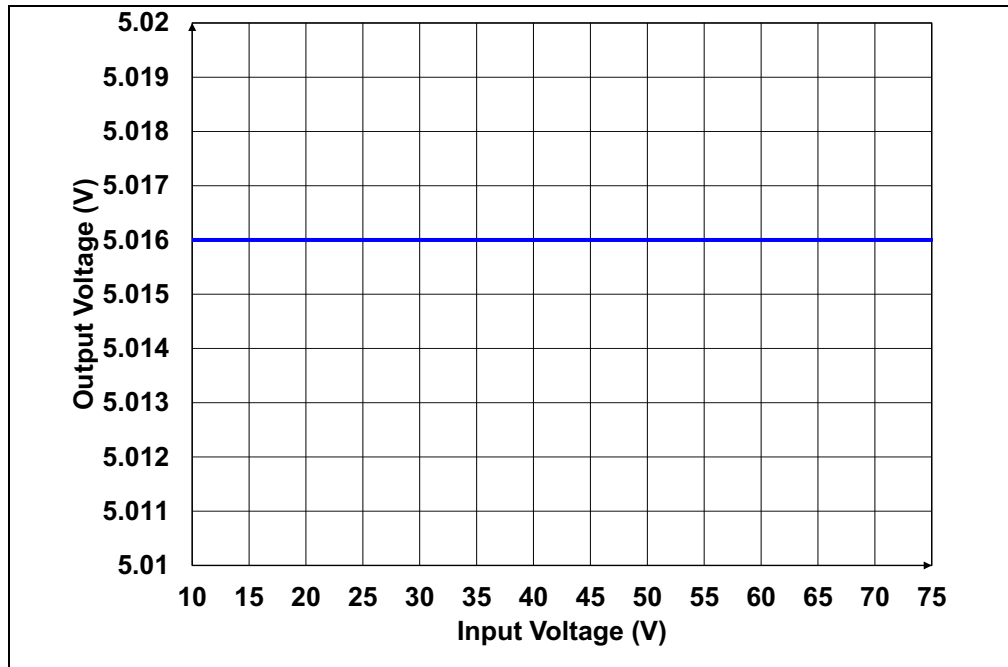

FIGURE C-7: Input and Output Voltage.

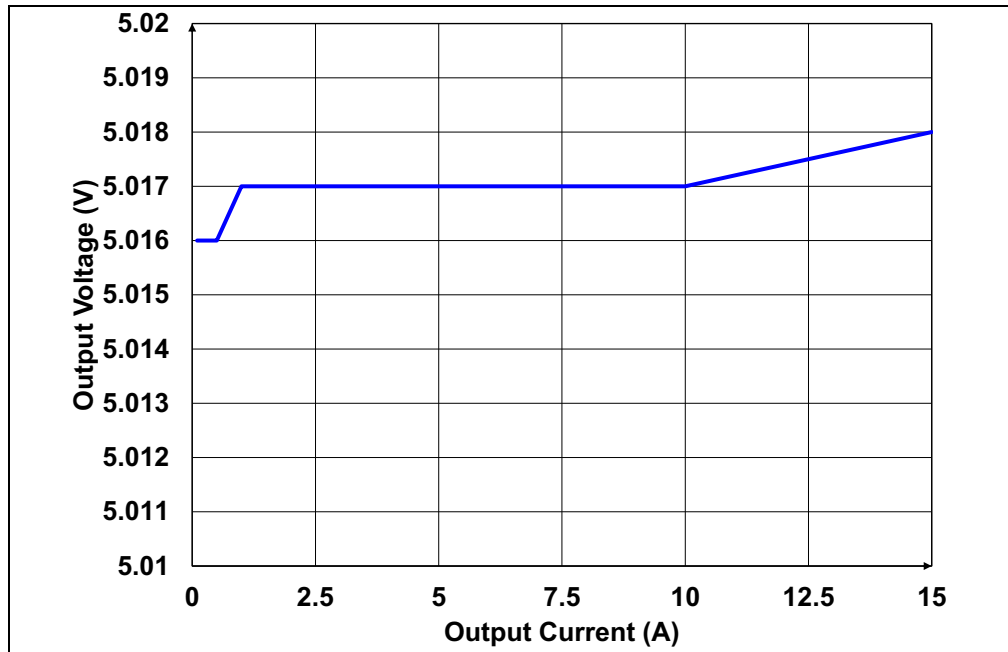

FIGURE C-8: Output Voltage vs Output Current  $V_{IN} = 12V$ .

# Board Performance Curves and Waveforms

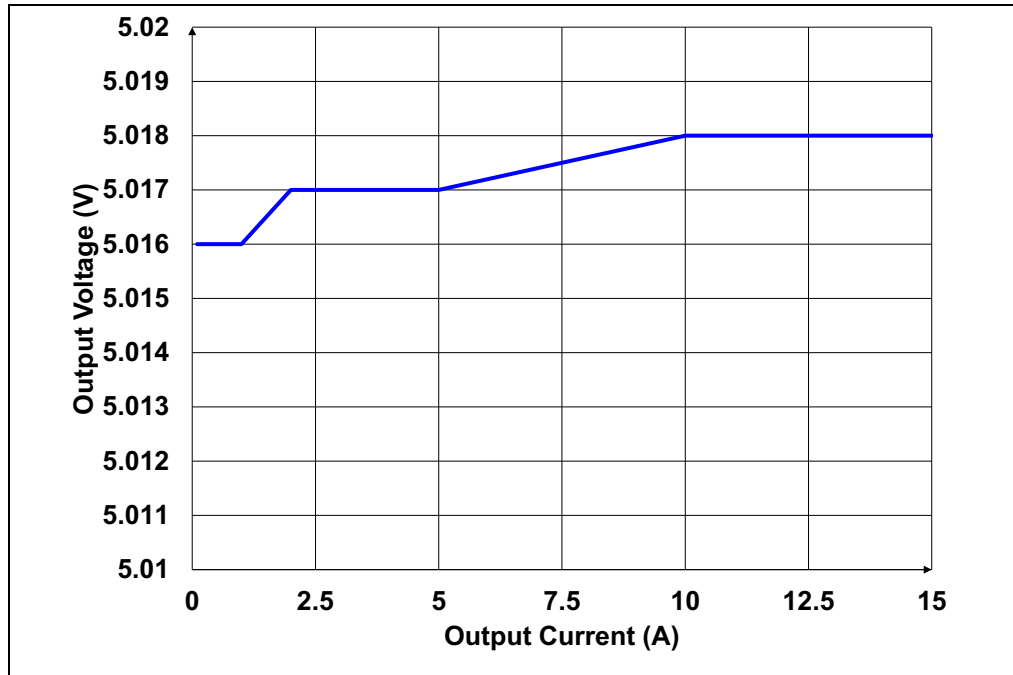

FIGURE C-9: Output Voltage vs Output Current  $V_{IN} = 24V$ .

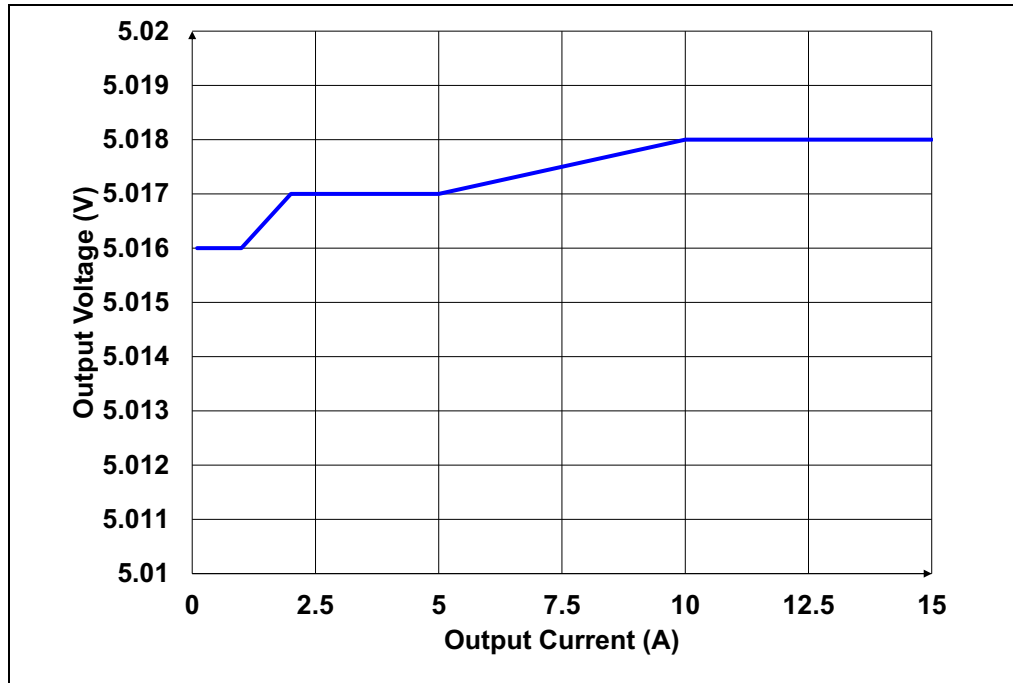

FIGURE C-10: Output Voltage vs. Output Current  $V_{IN} = 48V$ .

# MIC2133 Evaluation Board User's Guide

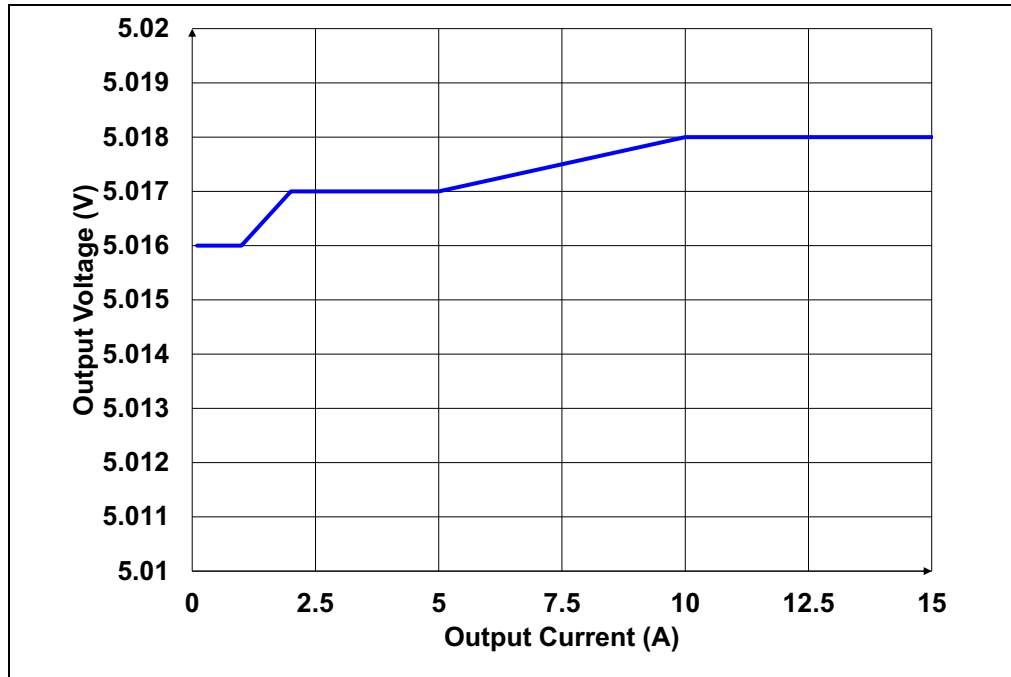

FIGURE C-11: Output Voltage vs Output Current  $V_{in} = 60V$ .

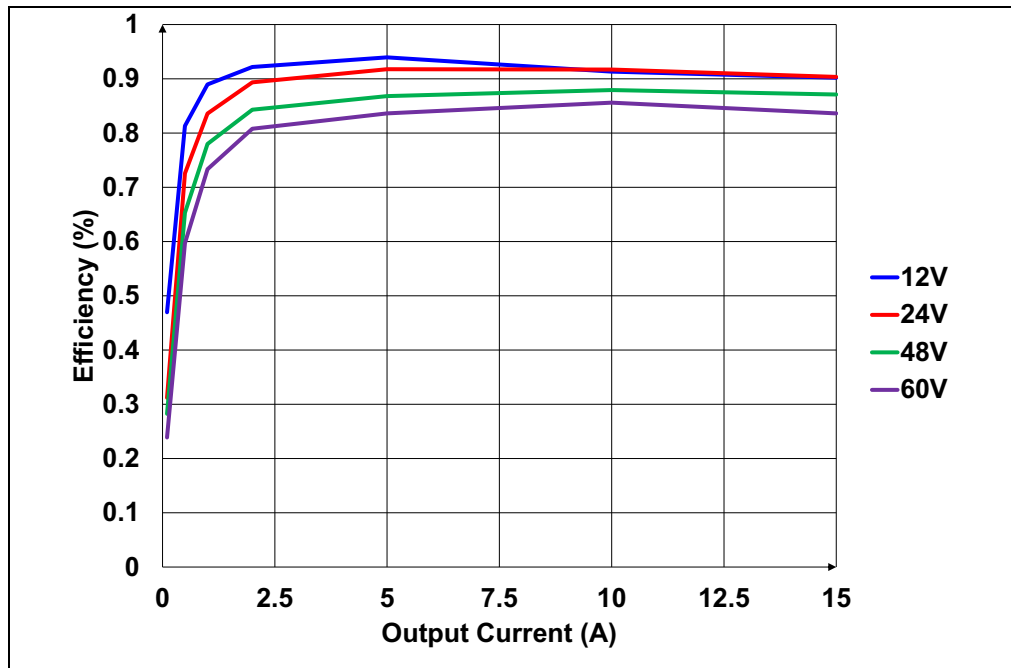

FIGURE C-12: Efficiency vs Output Current.





# MICROCHIP

## Worldwide Sales and Service

### AMERICAS

**Corporate Office**  
2355 West Chandler Blvd.  
Chandler, AZ 85224-6199  
Tel: 480-792-7200  
Fax: 480-792-7277  
Technical Support:  
<http://www.microchip.com/support>  
Web Address:  
[www.microchip.com](http://www.microchip.com)

#### Atlanta

Duluth, GA  
Tel: 678-957-9614  
Fax: 678-957-1455

#### Austin, TX

Tel: 512-257-3370

#### Boston

Westborough, MA  
Tel: 774-760-0087  
Fax: 774-760-0088

#### Chicago

Itasca, IL  
Tel: 630-285-0071  
Fax: 630-285-0075

#### Dallas

Addison, TX  
Tel: 972-818-7423  
Fax: 972-818-2924

#### Detroit

Novi, MI  
Tel: 248-848-4000

#### Houston, TX

Tel: 281-894-5983

#### Indianapolis

Noblesville, IN  
Tel: 317-773-8323  
Fax: 317-773-5453  
Tel: 317-536-2380

#### Los Angeles

Mission Viejo, CA  
Tel: 949-462-9523  
Fax: 949-462-9608  
Tel: 951-273-7800

#### Raleigh, NC

Tel: 919-844-7510

#### New York, NY

Tel: 631-435-6000

#### San Jose, CA

Tel: 408-735-9110  
Tel: 408-436-4270

#### Canada - Toronto

Tel: 905-695-1980  
Fax: 905-695-2078

### ASIA/PACIFIC

**Australia - Sydney**  
Tel: 61-2-9868-6733

**China - Beijing**  
Tel: 86-10-8569-7000

**China - Chengdu**  
Tel: 86-28-8665-5511

**China - Chongqing**  
Tel: 86-23-8980-9588

**China - Dongguan**  
Tel: 86-769-8702-9880

**China - Guangzhou**  
Tel: 86-20-8755-8029

**China - Hangzhou**  
Tel: 86-571-8792-8115

**China - Hong Kong SAR**  
Tel: 852-2943-5100

**China - Nanjing**  
Tel: 86-25-8473-2460

**China - Qingdao**  
Tel: 86-532-8502-7355

**China - Shanghai**  
Tel: 86-21-3326-8000

**China - Shenyang**  
Tel: 86-24-2334-2829

**China - Shenzhen**  
Tel: 86-755-8864-2200

**China - Suzhou**  
Tel: 86-186-6233-1526

**China - Wuhan**  
Tel: 86-27-5980-5300

**China - Xian**  
Tel: 86-29-8833-7252

**China - Xiamen**  
Tel: 86-592-2388138

**China - Zhuhai**  
Tel: 86-756-3210040

### ASIA/PACIFIC

**India - Bangalore**  
Tel: 91-80-3090-4444

**India - New Delhi**  
Tel: 91-11-4160-8631

**India - Pune**  
Tel: 91-20-4121-0141

**Japan - Osaka**  
Tel: 81-6-6152-7160

**Japan - Tokyo**  
Tel: 81-3-6880-3770

**Korea - Daegu**  
Tel: 82-53-744-4301

**Korea - Seoul**  
Tel: 82-2-554-7200

**Malaysia - Kuala Lumpur**  
Tel: 60-3-7651-7906

**Malaysia - Penang**  
Tel: 60-4-227-8870

**Philippines - Manila**  
Tel: 63-2-634-9065

**Singapore**  
Tel: 65-6334-8870

**Taiwan - Hsin Chu**  
Tel: 886-3-577-8366

**Taiwan - Kaohsiung**  
Tel: 886-7-213-7830

**Taiwan - Taipei**  
Tel: 886-2-2508-8600

**Thailand - Bangkok**  
Tel: 66-2-694-1351

**Vietnam - Ho Chi Minh**  
Tel: 84-28-5448-2100

### EUROPE

**Austria - Wels**  
Tel: 43-7242-2244-39  
Fax: 43-7242-2244-393

**Denmark - Copenhagen**  
Tel: 45-4485-5910  
Fax: 45-4485-2829

**Finland - Espoo**  
Tel: 358-9-4520-820

**France - Paris**  
Tel: 33-1-69-53-63-20  
Fax: 33-1-69-30-90-79

**Germany - Garching**  
Tel: 49-8931-9700

**Germany - Haan**  
Tel: 49-2129-3766400

**Germany - Heilbronn**  
Tel: 49-7131-72400

**Germany - Karlsruhe**  
Tel: 49-721-625370

**Germany - Munich**  
Tel: 49-89-627-144-0  
Fax: 49-89-627-144-44

**Germany - Rosenheim**  
Tel: 49-8031-354-560

**Israel - Ra'anana**  
Tel: 972-9-744-7705

**Italy - Milan**  
Tel: 39-0331-742611  
Fax: 39-0331-466781

**Italy - Padova**  
Tel: 39-049-7625286

**Netherlands - Drunen**  
Tel: 31-416-690399  
Fax: 31-416-690340

**Norway - Trondheim**  
Tel: 47-7288-4388

**Poland - Warsaw**  
Tel: 48-22-3325737

**Romania - Bucharest**  
Tel: 40-21-407-87-50

**Spain - Madrid**  
Tel: 34-91-708-08-90  
Fax: 34-91-708-08-91

**Sweden - Gothenberg**  
Tel: 46-31-704-60-40

**Sweden - Stockholm**  
Tel: 46-8-5090-4654

**UK - Wokingham**  
Tel: 44-118-921-5800  
Fax: 44-118-921-5820