

EAO Emergency Stop and Stop Switches.

Safe, intuitive and reliable.

www.eao.com

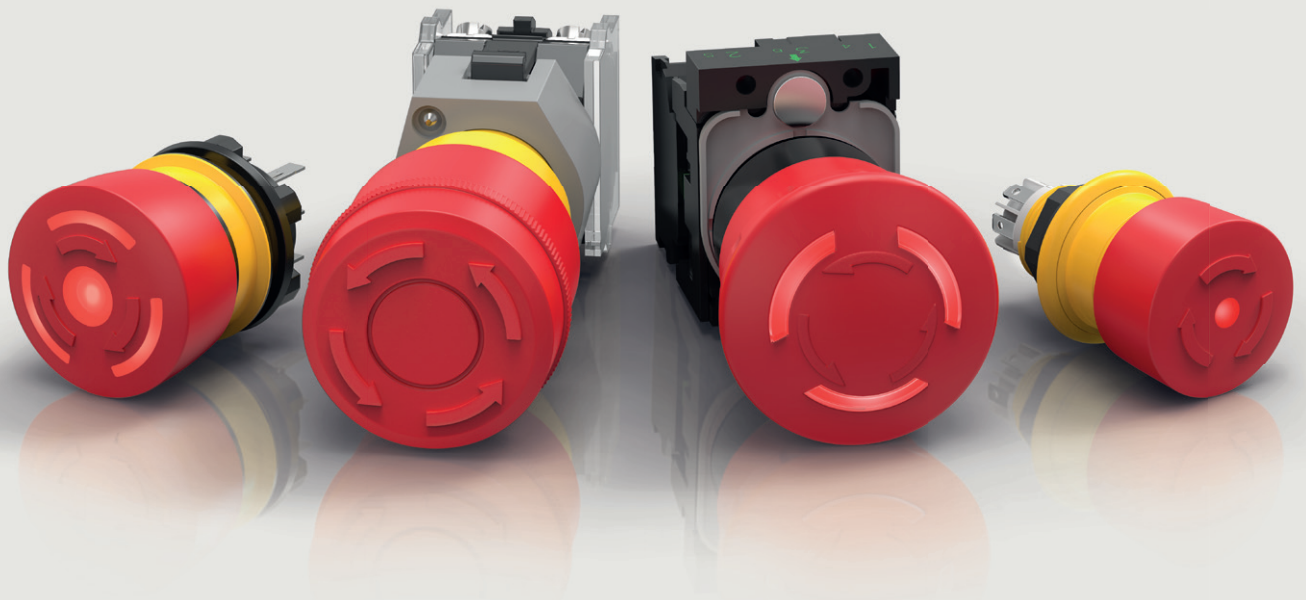

EAO Emergency Stop and Stop Switches.

Safe, intuitive and reliable.

Intuitive EAO emergency stop switches reliably protect end users from injury and equipment from damage – even in harsh environments and space critical applications.

The correct HMI selection is crucial for the reliability of safety-related functions. The terminology used and the characteristics of emergency stop switches is clearly explained below. EAO offers an extensive range of intuitive and reliable emergency stop and stop switches to meet the requirements of a wide variety of applications.

Emergency stop or emergency off?

When used in Germany the two functions (1) emergency off is equal to switching off, interrupting the energy supply and (2) emergency stop is equal to stopping or shutting down mov-

ing machine parts. These two functions are often subsumed under the term “emergency off”, which sometimes leads to confusion – even among experts. The term “emergency off” is used as the German equivalent of the English term “emergency switching off”. However, there have been, and still are, German standard editions which also incorrectly use the English term “emergency stop” for the expression “emergency off”. To this day, the German version of DIN EN 60947-5-5 mistakenly uses the term “emergency off” for the English term “emergency stop”, which actually describes the emergency stop.

ISO 13850 corrected this in 2016 and speaks of emergency stop. In the new version of the Machinery Directive (2006/42/EC and 2009/127/EC), the wrong term was also replaced with emergency stop.

Emergency stop = Stop in an emergency
Emergency off = Switching off in an emergency

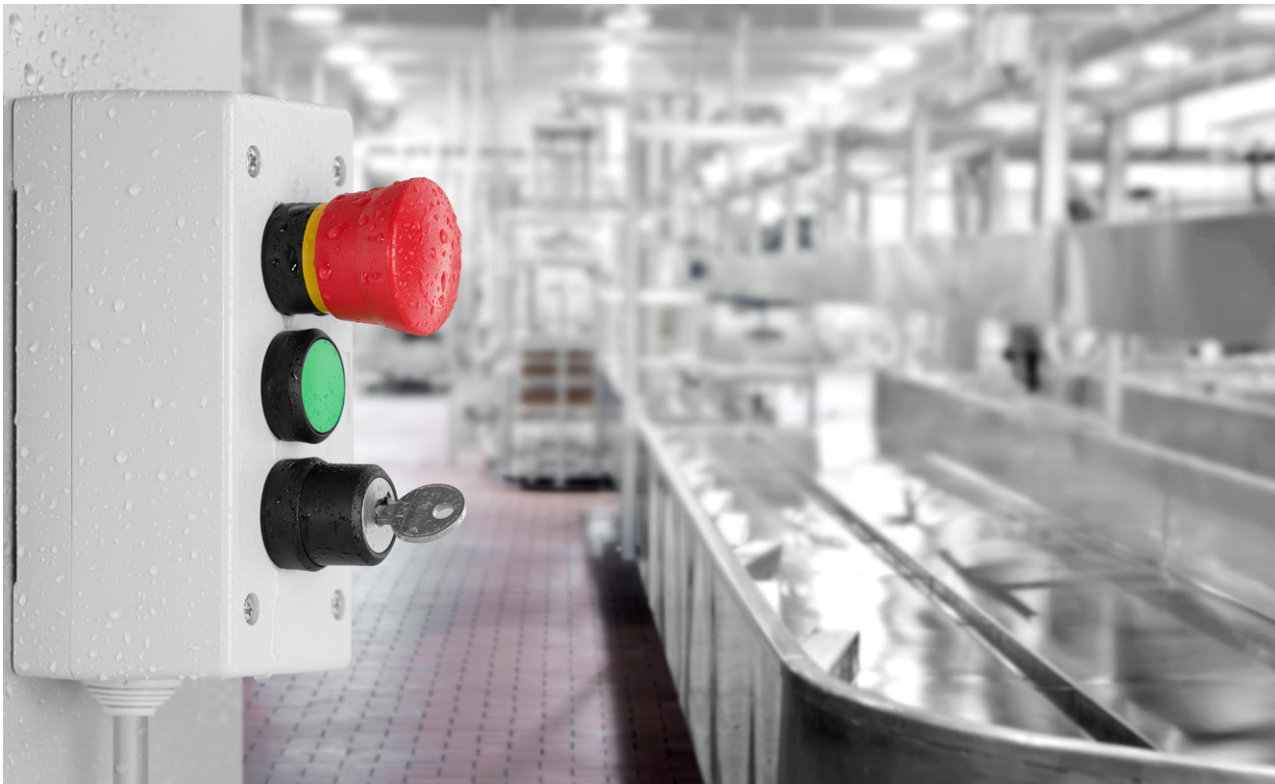

Machines covered by the Machinery Directive (2006/42/EC) must be equipped with at least one emergency stop actuator that can prevent an imminent or occurring hazard.

According to the standards, an emergency stop actuator must have, among other things, the following:

- A red actuator head with yellow background
- Unlocking arrows in the same colour as the actuator, i.e. red, if unlocking happens by rotating the actuator
- No symbols or text on the actuator or background (with the exception of a symbol according to IEC 60417-5638)
- Optional yellow label with ISO 13850 symbol
- Positive opening contacts
- Fool-proof latching
- A twist, pull or key to release, although the latter should be avoided

Why red and not white arrows?

With a twist release, the direction of the twist move must be visible in accordance with DIN EN 60947-5-5. For this reason, white arrows were often attached on the actuator until 2016. However, these high-contrast white arrows on the red actuator could be misunderstood as the direction of actuation. To avoid this, DIN EN 13850 states that the unlocking arrows must be designed with a low-contrast colour that is preferably identical to the background.

Positive opening and fool-proof security

Contact separation must be a direct result of a movement of the operating part and must not depend on a spring. For identification purposes, each positive opening contact is marked with the following symbol.



All EAO emergency stop devices are tested according to EN 60947-5-1 and EN 60947-5-5 and are suitable for applications according to DIN EN ISO 13850 and EN 60204 1.

EAO emergency stop devices are always fool-proof. This means that no contact may open before the mechanical latching has taken place, but must then open immediately. The standard describes that the emergency stop device must not lock without generating an emergency stop signal (EN 60947-5-5, section 6.2.1. The German version still – as of 03/2019 – uses the term “EMERGENCY OFF”, but the English version uses the correct term “Emergency Stop”).

The robust EAO emergency stop switches with positive opening function (according to DIN EN ISO 13850 and EN 60204-1) are fool-proof. This means that after the release process has been carried out, the switching element is safely actuated and the actuator engages. Resetting is possible only through a deliberate unlocking without restarting the machine solely by this process. Restarting is made possible only with the release.

What is the difference between emergency stop and stop switches?

Stop switches do not have to fully comply with the standards and specifications mentioned above and therefore have a less sophisticated design. For example, they do not have to be fool-proof, i.e. the contact can open before the mechanical locking has taken place. The unlocking may lead to a restart of a machine with the stop switch. This is why the stop switch is often used as an On/Off button. In addition, the colours of the actuators do not have to be red and the background does not necessarily have to be yellow. Stop switches can also have snap-action switching elements. A positive opening contact is not mandatory. The EAO stop switch range offers a wide choice of actuator colours to meet all design requirements.

Overview.

EAO E-stops and stop switches.

Product attributes	EAO Series				
	04	45	61 compact	61	84
Release					
Twist to release	■	■	■	■	■
Pull to release		■			
Key to release	■	■		■	
Mounting cut-out					
Ø 16.2 mm			■	■	
Ø 22.3 mm	■	■			■
IP protection					
IP65	■	■	■	■	■
IP66		■	■		
IP67		■	■		■
IP69K		■	■		
Max. number of contacts					
2				■	■
3			■		
4	■				
6		■			
Optional illumination					
Yes		■	■		■
Terminal					
PCB (with adaptor)				■	■
Solder terminal			■		■
Plug-in terminal	■		■	■	■
Cable connection					■
Screw terminal	■	■		■	
Push-in terminal	■	■			
Approvals					
UL	■	■	■	■	■
CE	■	■	■	■	■
CCC		■			■
CSA		■			
EN 60947-5-5	■	■	■	■	■
ISO EN 13850	■	■	■	■	■

Series 61 E-stop switch compact.

Compact, robust, reliable.

Typical applications

- Handheld control units
- Production and plant machinery
- Construction machinery
- Agricultural machinery and vehicles
- Specialty vehicles

Advantages

- Very low back panel depth
- High front protections IP66, IP67 and IP69K
- Robust mono-block design with mechanically decoupled triggering
- Optional illumination
- Up to three switching elements

Technical data

- Mounting cut-out: 16.2 mm
- Plug-in terminal 2.8 mm x 0.5 mm
- Service life $\geq 20,000$ cycles of operation
- Front protection IP66, IP67 and IP69K
- Approved according to CB, UL
- Switch rating max. 50V, max 0.2A

Ø27mm without illumination



Contacts	Part No.
1 NC contact	61-6441.4047
2 NC contact	61-6441.4057
3 NC contact	61-6441.4067
1 NC contact + 1 NO contact	61-6441.4077
2 NC contact + 1 NO contact	61-6441.4087
1 NC contact + 2 NO contact	61-6441.4097

Ø27mm with illumination



Contacts	Part No.
1 NC contact	61-6451.4247
2 NC contact	61-6451.4257
1 NC contact + 1 NO contact	61-6451.4277

Ø40mm without illumination



Contacts	Part No.
1 NC contact	61-6461.4047
2 NC contact	61-6461.4057
3 NC contact	61-6461.4067
1 NC contact + 1 NO contact	61-6461.4077
2 NC contact + 1 NO contact	61-6461.4087
1 NC contact + 2 NO contact	61-6461.4097

Dimensions

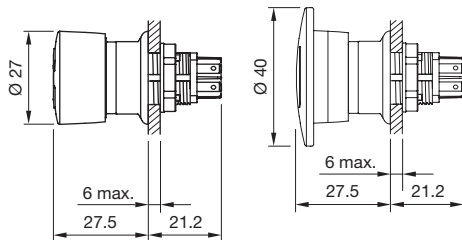

Mounting cut-out

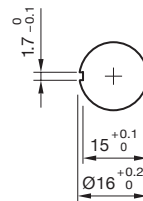

All dimensions in mm.

Series 84 emergency stop switches.

Compact, attractive, reliable.

Typical applications

- Industrial or process automation equipment
- Machinery, in particular for handheld control units
- Robotics
- Material handling and lifting platforms
- Medical devices

Advantages

- Robust mono-block with a foolproof and fail-safe design
- Very low back panel depth
- Attractive, modern design and protection IP65/67
- Reliable and long service life
- Clearly visible illumination

Technical data

- Mounting cut-out: 22.3 mm
- Plug-in (2.8 mm x 0.5 mm) and 300mm flat ribbon cable connection
- IP65/67 front protection
- Approved according to CB, UL, CCC
- Switch rating max. 250V, max. 3A

Dimensions

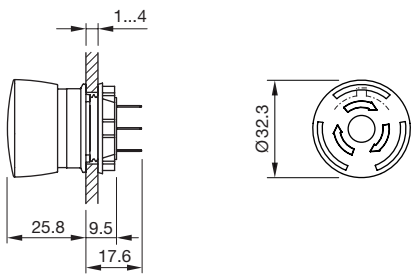

Plug-in terminal without illumination



Contacts	Part No.
1 NC contact	84-5220.0020
2 NC contact	84-5240.0020
1 NC contact + 1 NO contact	84-5230.0020

Plug-in terminal with illumination



Contacts	Part No.
1 NC contact	84-5221.2B20
2 NC contact	84-5241.2B20
1 NC contact + 1 NO contact	84-5231.2B20

Flat ribbon cable with illumination

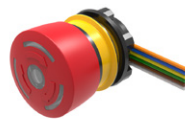

Contacts	Part No.
1 NC contact	84-5221.2B40
2 NC contact	84-5241.2B40
1 NC contact + 1 NO contact	84-5231.2B40

Mounting cut-out

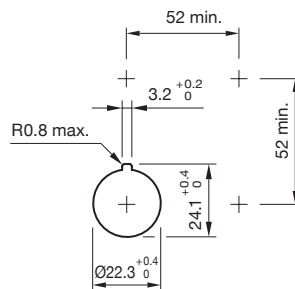

All dimensions in mm.

Series 04 emergency stop switches.

Rugged and reliable.

Typical applications

- Driver's cabs in the transport area
- Main operator panels for machines

Advantages

- Up to four switching contacts
- Various connection options
- Complies with fire protection standard EN 45545

Technical data

- Mounting cut-out: 22.3mm
- Screw, plug-in or spring-type terminal
- IP65 front protection
- Twist or key to release
- Silver or gold contacts available
- Switch rating max 500V, max. 10A

Dimensions

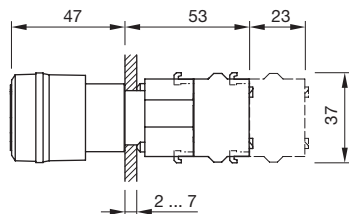

Actuator including mounting flange

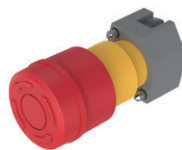

Release	Part No.
Twist to release	704.064.2A
Key to release	704.066.2A

Switching element (screw terminals)



Contacts	Part No.
2 NO contact	704.910.3
2 NC contact	704.910.4
1 NC contact + 1 NO contact	704.910.5

Mounting cut-out

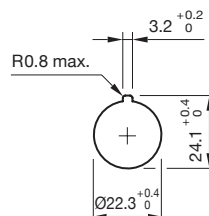

All dimensions in mm.

Series 45 emergency stop switches.

Safe, intuitive and reliable.

Typical applications

- Food and beverage industry
- Main operator panel for machinery
- User interface for industrial automation equipment
- Agricultural machinery and vehicles

Advantages

- Reliable switching
- Optional illumination
- Robust metal or plastic body versions
- IP69K protection
- Key, twist or pull to release options
- Different actuator shapes and sizes

Technical data

- Mounting cut-out: 22.3 mm
- Screw or spring-type terminal
- Front protection types IP66, IP67 and IP69K
- Approved according to UL, CSA, CCC
- Switch rating max 500V, max. 10A

Dimensions

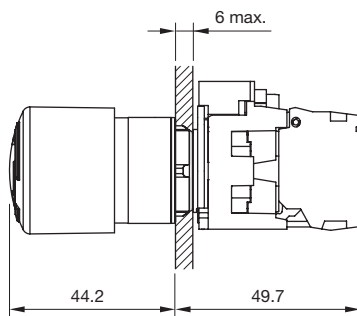

Ø40mm Actuator



Housing material	Illumination	Part No.
Plastic	Yes	45-2D36.1920.000
Plastic	No	45-2C36.1920.000
Metal	Yes	45-2D36.2920.000
Metal	No	45-2C36.2920.000

Switching element (Screw terminal)



Contacts	Contact material	Part No.
1 NC contact	Silver	45-312.1Z10
1 NC contact	Gold	45-312.1X10
1 NO contact	Silver	45-311.1Z10
1 NO contact	Gold	45-311.1X10

Holder



Housing material	Part No.
Plastic	45-2D36.1920.000
Metal	45-2C36.1920.000

Mounting cut-out

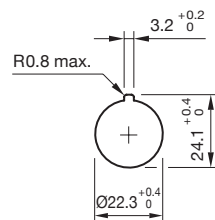

All dimensions in mm.

EAO Smart Box.

Simple, compact and all-purpose.

The EAO Smart Box is a simple and customisable “snap-on, plug & play” solution for operator devices in industrial environments.

Thanks to the standardised M12 terminal, the Smart Box can be brought into service quickly and easily. The device can also be mounted on a standard top hat rail without the need for a mounting adapter.

Advantages

- Simple snap-on mounting and M12 connection technology
- Flexible arrangement and robust, compact construction
- Ease of integration into the system thanks to bus connection or direct wiring
- Customisable front design and functionality
- Standard range available – customised solutions on request

Smart Box	Description	Illumination	Part No.
	Yellow housing with M12 Series 84 emergency stop switch	Yes	73-00002.2
		No	73-00002.1



Dimensions

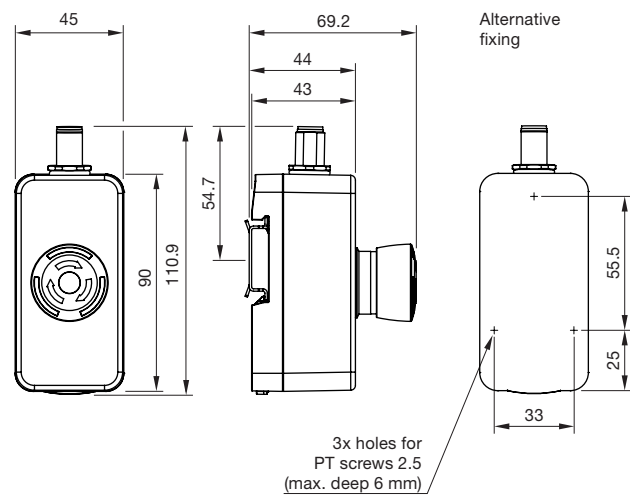

All dimensions in mm.

Series 61 emergency stop switches. *Modular and recognised worldwide.*

Technical data

- Mounting cut-out 16.2 mm
- IP65 front protection
- Screw or plug-in terminal
- Up to 2 contacts (switching element separate)

Actuator



Housing material	Part No.
Plastic	61-3440.4/3

Switching elements (Screw terminal)



Contacts	Part No.
1 NC contact	61-8745.11
2 NC contact	61-8755.11
1 NC contact + 1 NO contact	61-8775.11

Switching elements (Plug-in terminal)



Contacts	Part No.
1 NC contact	61-8745.17
2 NC contact	61-8755.17
1 NC contact + 1 NO contact	61-8775.17

Series 45 palm switches. *Intuitive and extra-large.*

Thanks to its extra-large operating area, the clearly visible palm switch is ideal for use in harsh environments when sudden, uncoordinated movements must suffice to trigger a certain command. The device can either be operated with a flat hand, work gloves, or with an elbow and reset with a pull-release. The switching elements have to be ordered separately.

Advantages

- Extra-large operating area
- Also suitable for emergency stop functions
- Quick to install and easy to use
- Robust IP69K front protection

Palm switch

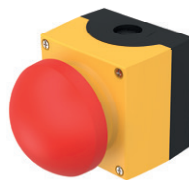

Housing material	Part No.
Plastic	45-482.1810
Metal	45-482.2810

EAO stop switches.

Robust and reliable.

Series 04 stop switches



Front bezel	Marking	Part No.
Plastic grey	Arrows	704.074.2
Aluminium natural	Arrows	704.075.2
Aluminium natural	None	704.075.3

Please order switching elements separately.

Series 51 stop switches



Contacts	Terminal	Part No.
2 NC contact	Universal	51-252.026
1 NC contact + 1 NO contact	Soldering	51-256.025
1 NC contact + 1 NO contact	Plug-in	51-253.022

Series 61 stop switches



Marking	Part No.
STOP	61-5441.4/K
Arrows	61-3440.4/D
STOP + Arrows	61-3440.4/2

Series 84 stop switches

With plug-in terminal 2.8 mm x 0.5 mm



Contacts	Illumination	Part No.
1 NC contact	No	84-6220.0020
2 NC contact	No	84-6240.0020
1 NC contact + 1 NO contact	No	84-6230.0020
1 NC contact	Yes	84-6221.2B20
2 NC contact	Yes	84-6241.2B20
1 NC contact + 1 NO contact	Yes	84-6231.2B20

EAO accessories.

For your application.

Marking plate

	Suitable for	Outer diameter	Text/symbol	Part No.
	S61	43 mm	Without	61-9970.0
	S61	43 mm	EMERGENCY STOP	61-9970.2
	S61	43 mm	Symbol IEC 60417-5638	61-9970.9
	S04, 45, 84	90 mm	EMERGENCY STOP	704.963.1
	S04, 45, 84	60 mm	EMERGENCY STOP	704.963.6
	S04, 45, 84	90 mm	Symbol IEC 60417-5638	704.963.4
	S04, 45, 84	60 mm	Symbol IEC 60417-5638	704.963.9
	S04, 45, 84	45 mm	Without	45-50K.1407
	S04, 45, 84	75 mm	Without	45-50J.1400

Protective shroud

	Suitable for	Text/symbol	Part No.
	S04	EMERGENCY STOP	704.927.6B
	S04	Without	704.927.6
	S84	EMERGENCY STOP	84-902B
	S84	Without	84-902

Enclosure

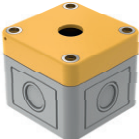
	Suitable for	Dimensions	Part No.
	S61	L 65 mm x W 65 mm x H 57 mm	61-9480.5
	S45	L 85 mm x W 85 mm x H 64 mm	45-410.1401
	S04, 45, 84	L 94 mm x W 94 mm x H 81 mm	704.945.0
	S04, 45, 84	L 65 mm x W 65 mm x H 81 mm	704.945.7

PCB plug-in base

	Suitable for	Part No.
	Suitable for Series 84 emergency stop and stop switches with plug-in terminal	84-920

New EAO E-Stop Switch Configurator.

Intuitive use. Fast delivery time.

IP-Rating

How resistant should your E-Stop be?

IP66 ×

IP67 ×



View **2** Assemblies with **15** Variants



Visit us at hmi.eao.com

- Intuitive use
- More than 2 000 product combinations
- Responsive user interface
- Photorealistic 3D representations
- 3D CAD data and datasheets
- 24 h ordering – fast delivery

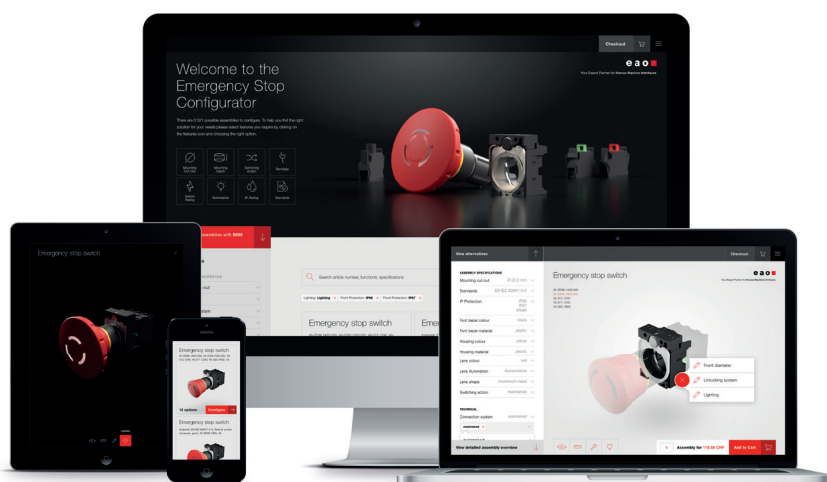

Adaptable.
Your application – our strength.



Our comprehensive programme of standard components coupled with our ability to adapt and customise our products enable us to provide individually tailored solutions for a broad range of applications.

EAO products and solutions provide front protection against moisture, coolants, oil and dirt and are resistant to shock, vibration, dust and extreme fluctuations in temperature.

With long service life in mind, we develop reliable high-quality operating concepts for machines that comply with IP, NEMA, IEC, ADA, ANSI and OSHA specifications. Multifunctional utilisation and ease of modification make our products economical and suitable for use virtually everywhere.



Our HMI Components and Systems meet the specifications of the world's leading plant manufacturers in the realms of machinery and industrial automation technology and are used successfully in a wide range of industries.

Applications

- Food and beverages
- Semiconductor and electronics production
- Packaging systems
- CNC milling, lathing, grinding and boring equipment
- Tobacco production and process control
- Industrial lifting and handling automation
- Pharmaceutical and chemical production and process control
- Cooling and ventilation equipment
- Textile production, including equipment for preparing, drying, spinning and weaving
- Plus many other applications

You too can benefit from our impressive portfolio, which offers you the ideal solution for every conceivable HMI application.

EAO Contact.

Your centre of excellence.

Headquarters

EAO Holding AG
Tannwaldstrasse 88
CH-4600 Olten
Telephone +41 62 286 92 00
info@eao.com

Manufacturing Companies

Switzerland

EAO AG
Tannwaldstrasse 88
CH-4600 Olten
Telephone +41 62 286 91 11
info@eao.com

EAO Systems AG

Tannwaldstrasse 88
CH-4600 Olten
Telephone +41 62 286 91 11
sales.esy@eao.com

China

EAO (Guangzhou) Ltd.
3/F, Block G4, South China
New Materials Innovation Park
31 Kefeng Road
Guangzhou Science City
CN-Guangzhou, PRC
Telephone +86 20 3229 0390
sales.ecn@eao.com

Germany

EAO Automotive GmbH & Co. KG
Richard-Wagner-Straße 3
DE-08209 Auerbach/Vogtland
Telephone +49 3744 8264 0
sales.esa@eao.com

North America

EAO Corporation
One Parrott Drive
Shelton
US-CT 06484
Telephone +1 203 951 4600
sales.eus@eao.com

Sales Companies

China

EAO (Guangzhou) Ltd.
3/F, Block G4, South China
New Materials Innovation Park
31 Kefeng Road
Guangzhou Science City
CN-Guangzhou, PRC
Telephone +86 20 3229 0390
sales.ecn@eao.com

EAO (Shanghai) Office

Rm.401, Lihpao Plaza,
NO.159 Shenwu Road,
Minhang District,
CN-Shanghai, 201106.
PRC
Telephone +86 21 6095 0717
sales.ecn@eao.com

France

EAO France SAS
Bâtiment Silex
15 rue des Cuirassiers
CS 33821
FR-69487 Lyon Cedex 03
Telephone +33 9 74 18 93 41
sales.efr@eao.com

Germany, Austria, Czech Republic, Poland, Slovakia

EAO GmbH
Langenberger Straße 570
DE-45277 Essen
Telephone +49 201 8587 0
sales.ede@eao.com

Hong Kong (Asia Pacific)

EAO (Far East) Ltd.
Unit A1, 1/F, Block A
Tin On Industrial Building
777 Cheung Sha Wan Road
Lai Chi Kok, Kln
HK-Hong Kong
Telephone +852 27 86 91 41
sales.ehk@eao.com

Italy

EAO Italia S.r.l.
Centro Direzionale Summit –
Palazzo C1
Via Brescia 26
IT-20063 Cernusco sul Naviglio (MI)
Telephone +39 029 247 0722
sales.eit@eao.com

Japan

EAO Japan Co. Ltd.
Net 1 Mita Bldg. 3F
3-1-4 Mita Minato-ku
JP-Tokyo 108-0073
Telephone +81 3 5444 5411
sales.ejp@eao.com

Netherlands, Belgium

EAO Benelux B.V.
Kamerlingh Onnesweg 46
NL-3316 GL Dordrecht
Telephone +31 78 653 17 00
sales.enl@eao.com

North America

EAO Corporation
One Parrott Drive
Shelton
US-CT 06484
Telephone +1 203 951 4600
sales.eus@eao.com

Switzerland

EAO Schweiz AG
Tannwaldstrasse 86
CH-4600 Olten
Telephone +41 62 286 95 00
sales.ech@eao.com

United Kingdom, Denmark, Finland, Ireland, Norway, Sweden

EAO Ltd.
Highland House
Albert Drive
Burgess Hill
GB-West Sussex RH15 9TN
Telephone +44 1444 236 000
sales.euk@eao.com