



Digi XBee3[®]

RF Module

Hardware Reference Manual

Revision history—90001543

Revision	Date	Description
H	October 2018	Added South Korean certification for non-PRO devices.
J	October 2018	Added Brazilian certifications.
K	March 2019	Added BLE power output specifications. Added I2C pin specifications. Added a new antenna. Added XBee3 USB Adapter information.
L	April 2019	Added XBIB-C board information.
M	May 2019	Added FCC publication 996369 related information.

Trademarks and copyright

Digi, Digi International, and the Digi logo are trademarks or registered trademarks in the United States and other countries worldwide. All other trademarks mentioned in this document are the property of their respective owners.

© 2019 Digi International Inc. All rights reserved.

Disclaimers

Information in this document is subject to change without notice and does not represent a commitment on the part of Digi International. Digi provides this document “as is,” without warranty of any kind, expressed or implied, including, but not limited to, the implied warranties of fitness or merchantability for a particular purpose. Digi may make improvements and/or changes in this manual or in the product(s) and/or the program(s) described in this manual at any time.

Warranty

To view product warranty information, go to the following website:

www.digi.com/howtobuy/terms

Customer support

Gather support information: Before contacting Digi technical support for help, gather the following information:

- Product name and model
- Product serial number (s)
- Firmware version
- Operating system/browser (if applicable)

Logs (from time of reported issue)

Trace (if possible)

Description of issue

Steps to reproduce

Contact Digi technical support: Digi offers multiple technical support plans and service packages. Contact us at +1 952.912.3444 or visit us at www.digi.com/support.

Feedback

To provide feedback on this document, email your comments to

techcomm@digi.com

Include the document title and part number (Digi XBee3® RF Module Hardware Reference Manual, 90001543 K) in the subject line of your email.

Contents

Digi XBee3® RF Module Hardware Reference Manual

General XBee3 specifications

General specifications	9
Regulatory conformity summary	9
Serial communication specifications	10
UART pin assignments	10
SPI pin assignments	10
GPIO specifications	10
Electro Static Discharge (ESD)	11

IEEE 802.15.4-specific specifications

Performance specifications	13
Power requirements	13
Networking and security specifications	13
Communication interface specifications	14

Mechanical drawings

XBee3 surface-mount antennas	16
XBee3 surface-mount - U.FL/RF pad antenna	16
XBee3 surface-mount - embedded antenna	17
XBee3 micro antennas	18
XBee3 micro (U.FL/RF Pad)	18
XBee3 micro (chip antenna)	19
XBee3 through-hole antennas	20
XBee3 through-hole - PCB antenna	20
XBee3 through-hole - U.FL antenna	20
XBee3 through-hole - RPSMA antenna	21

Pin signals

Pin signals for the XBee3 surface-mount module	23
Pin signals for the XBee3 micro module	26
Pin signals for the XBee3 through-hole module	29
Recommended pin connections	30

Design notes

Power supply design	32
Board layout	32
Antenna performance	32
Design notes for PCB antenna and chip antenna devices	33
Surface-mount embedded antenna keepout area	33
XBee3 Micro chip antenna keepout area	34
Through-hole embedded antenna keepout area	35
Design notes for RF pad devices	35
Copper keepout for test points	38

Regulatory information

United States (FCC)	41
OEM labeling requirements	41
FCC notices	41
FCC-approved antennas (2.4 GHz)	42
RF exposure	50
XBee3 USB Adapter	50
FCC publication 996369 related information	50
Europe (CE)	51
Maximum power and frequency specifications	51
OEM labeling requirements	51
Declarations of conformity	52
Antennas	52
ISED (Innovation, Science and Economic Development Canada)	53
Labeling requirements	53
For XBee3	53
RF Exposure	53
Australia (RCM)/New Zealand	54
Japan (TELEC)	54
Brazil ANATEL	54
Modelo: XBee3	55
South Korea	55

XBIB-C development boards

XBIB-C Micro Mount reference	57
XBIB-C SMT reference	59
XBIB-CU TH reference	61
XBIB-C-GPS reference	63
Interface with the XBIB-C-GPS module	65
I2C communication	66
UART communication	66

Manufacturing information

Recommended solder reflow cycle	68
Handling and storage	68
Recommended footprint	68
Flux and cleaning	70
Reworking	71

Troubleshooting

Brownout issue	73
Voltage brownout	73
Voltage ramp up discontinuities	73
How to distinguish revision B parts	73

Digi XBee3[®] RF Module Hardware Reference Manual

This manual provides information for the XBee3 RF Module hardware. The XBee3 RF Module can be any of the following form factors:

- Micro-mount
- Through-hole
- Surface-mount

For more information about the operation and programming functions of the device, see:

- [XBee3 DigiMesh RF Module User Guide](#)
- [XBee3 Zigbee RF Module User Guide](#)
- [XBee3 802.15.4 RF Module User Guide](#)

General XBee3 specifications

The following tables provide general specifications for the hardware.

General specifications	9
Regulatory conformity summary	9
Serial communication specifications	10
GPIO specifications	10
Electro Static Discharge (ESD)	11

General specifications

The following table describes the general specifications for the devices.

Specification	XBee3/XBee3-PRO micro-mount	XBee3/XBee3-PRO surface-mount	XBee3/XBee3-PRO through-hole
Operating frequency band	ISM 2.4 – 2.4835 GHz		
Form factor	Micro-mount	Surface-mount	Through-hole
Dimensions	Micro-mount: 1.36 cm x 1.93 cm x 0.241 cm (0.534 in x 0.760 in x 0.095 in)	Surface-mount: 2.199 x 3.4 x 0.368 cm (0.866 x 1.33 x 0.145 in)	Through-hole: 2.438 x 2.761 cm (0.960 x 1.087 in)
Operating temperature	-40 to 85 °C (industrial)		
Antenna options	RF pad, chip antenna, or U.FL connector	RF pad, embedded antenna, or U.FL connector	RPSMA connector, embedded antenna, or U.FL connector
Analog-to-digital converter (ADC)	4 10-bit analog inputs	4 10-bit analog inputs	4 10-bit analog inputs

Regulatory conformity summary

This table describes the agency approvals for the devices.

Approval	XBee3	XBee3-PRO
United States (FCC Part 15.247)	FCC ID: MCQ-XBEE3	FCC ID: MCQ-XBEE3
Innovation, Science and Economic Development Canada (ISED)	IC: 1846A-XBEE3	IC: 1846A-XBEE3
FCC/IC Test Transmit Power Output range	-6.8 to +8 dBm	-6.8 to +19.9 dBm
Bluetooth® (XBee3 Zigbee only)	Declaration ID: D042514 QDID: 121268	Declaration ID: D042514 QDID: 121268
Australia	RCM	RCM
Brazil	ANATEL 06329-18-01209	ANATEL 06329-18-01209
Europe (CE)	Yes	No
Japan (TELEC)	R210-119309	No
RoHS	Compliant	
South Korea (KCC)	R-C-DIG-XBEE3	No

Serial communication specifications

The XBee3 RF Module supports Universal Asynchronous Receiver / Transmitter (UART) and Serial Peripheral Interface (SPI) serial connections.

UART pin assignments

UART pins	Device pin number		
	XBee3 micro-mount	XBee3 surface-mount	XBee3 through-hole
DOUT/DIO13	3	3	2
DIN / $\overline{\text{CONFIG}}$ /DIO14	4	4	3
$\overline{\text{CTS}}$ / DIO7	24	25	12
$\overline{\text{RTS}}$ / DIO6	27	29	16

SPI pin assignments

SPI pins	Device pin number		
	XBee3 micro-mount	XBee3 surface-mount	XBee3 through-hole
SPI_CLK	13	14	18
SPI_SSEL	14	15	17
SPI_MOSI	15	16	11
SPI_MISO	16	17	4
SPI_ATT $\overline{\text{N}}$	11	12	19

GPIO specifications

XBee3 RF Modules have 15 General Purpose Input / Output (GPIO) ports available. The exact list depends on the device configuration as some GPIO pads are used for purposes such as serial communication.

GPIO electrical specification	Value
Voltage - supply	2.1 - 3.6 V
Low switching threshold	0.3 x VCC
High switching threshold	0.7 x VCC
Input pull-up resistor value	40 k Ω (typical)

GPIO electrical specification	Value
Input pull-down resistor value	40 k Ω (typical)
Output voltage for logic 0	0.2 x VCC (maximum)
Output voltage for logic 1	0.8 x VCC (minimum)
Output source/sink current	50 mA (maximum)
Total output current (for GPIO pads)	200 mA (maximum)

Electro Static Discharge (ESD)

XBee3 RF Module pins are tolerant to human-body model ± 1.5 kV.

Note Take care to limit all electrostatic discharges to the device.

IEEE 802.15.4-specific specifications

The following tables provide specifications specific to the XBee3 RF Module when using the IEEE 802.15.4 physical layer, for example: XBee 802.15.4, Zigbee, DigiMesh, and so on.

Performance specifications	13
Power requirements	13
Networking and security specifications	13
Communication interface specifications	14

Performance specifications

The following table describes the performance specifications for the devices.

Specification	XBee3	XBee3-PRO
Indoor/urban range	Up to 60 m (200 ft)	Up to 90 m (300 ft)
Outdoor RF line-of-sight range	Up to 1200 m (4000 ft)	Up to 3200 m (2 mi)
RF Transmit power output (maximum)	6.3 mW (+8 dBm)	79 mW (+19 dBm)
BLE power output	6.3 mW (+8 dBm)	6.3 mW (+8 dBm)
RF data rate	250,000 b/s	
Receiver sensitivity	-103 dBm	

Note Range figure estimates are based on free-air terrain with limited sources of interference. Actual range will vary based on transmitting power, orientation of transmitter and receiver, height of transmitting antenna, height of receiving antenna, weather conditions, interference sources in the area, and terrain between receiver and transmitter, including indoor and outdoor structures such as walls, trees, buildings, hills, and mountains.

Power requirements

The following table describes the power requirements for the XBee3 RF Module.

Specification	XBee3	XBee3-PRO
Adjustable power	Yes	
Supply voltage	2.1 - 3.6 V	
Operating current (transmit, typical)	40 mA @ +3.3 V, +8 dBm	135 mA @ +3.3 V, +19 dBm
Operating current (receive, typical)	17 mA	
Power-down current, typical	2 μ A @ 25° C	

Networking and security specifications

The following table describes the networking and security specifications for the devices.

Specification	XBee3/XBee3-PRO
Supported network topologies	Point-to-point, point-to-multipoint, peer-to-peer, and DigiMesh
Number of channels	16 Direct sequence channels
Interface immunity	Direct Sequence Spread Spectrum (DSSS)
Channels	11 to 26
Addressing options	PAN ID and addresses, cluster IDs and endpoints (optional)

Communication interface specifications

The following table provides the device's communication interface specifications.

Interface options	
UART	Standard UART baud rates up to 921600 b/s Non-standard UART baud rates up to 967680 b/s
SPI	5 Mb/s (burst)

Mechanical drawings

The following mechanical drawings of the XBee3 RF Modules show all dimensions in inches.

XBee3 surface-mount antennas	16
XBee3 micro antennas	18
XBee3 through-hole antennas	20

XBee3 surface-mount antennas

The following mechanical drawings are for the XBee3 surface-mount antennas.

XBee3 surface-mount - U.FL/RF pad antenna

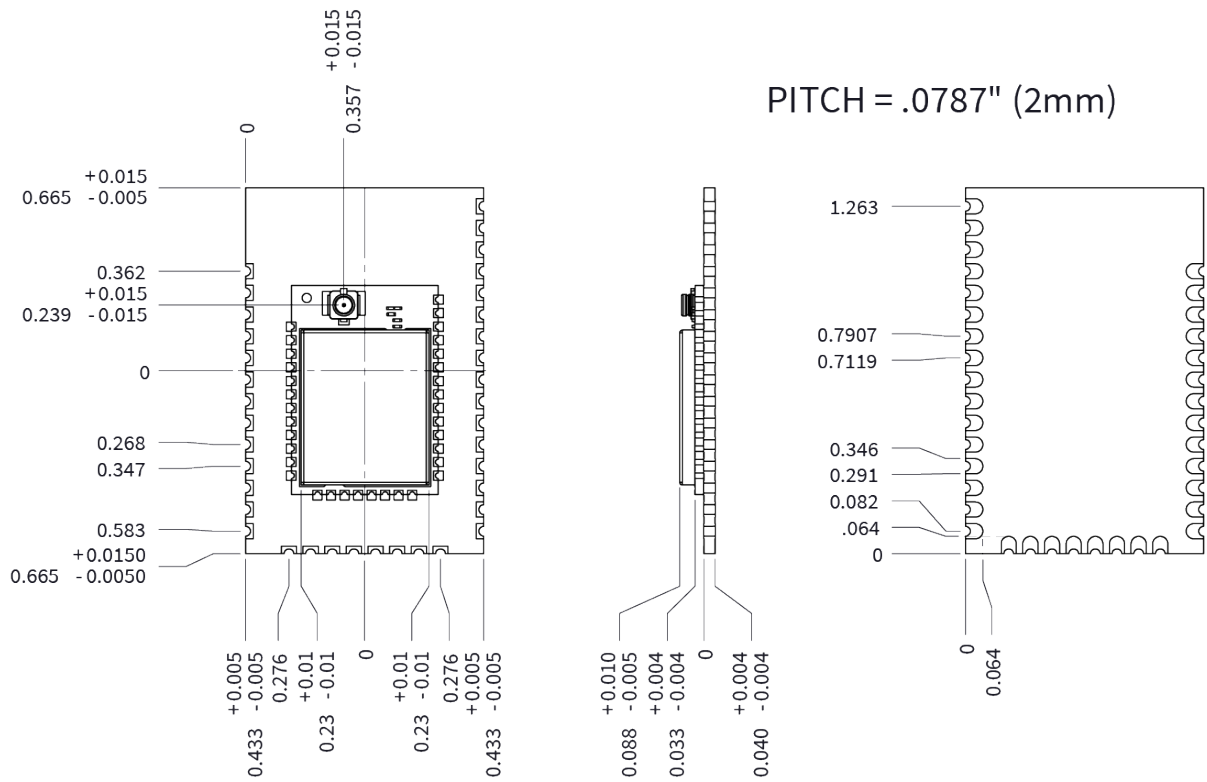

XBee3 surface-mount - embedded antenna

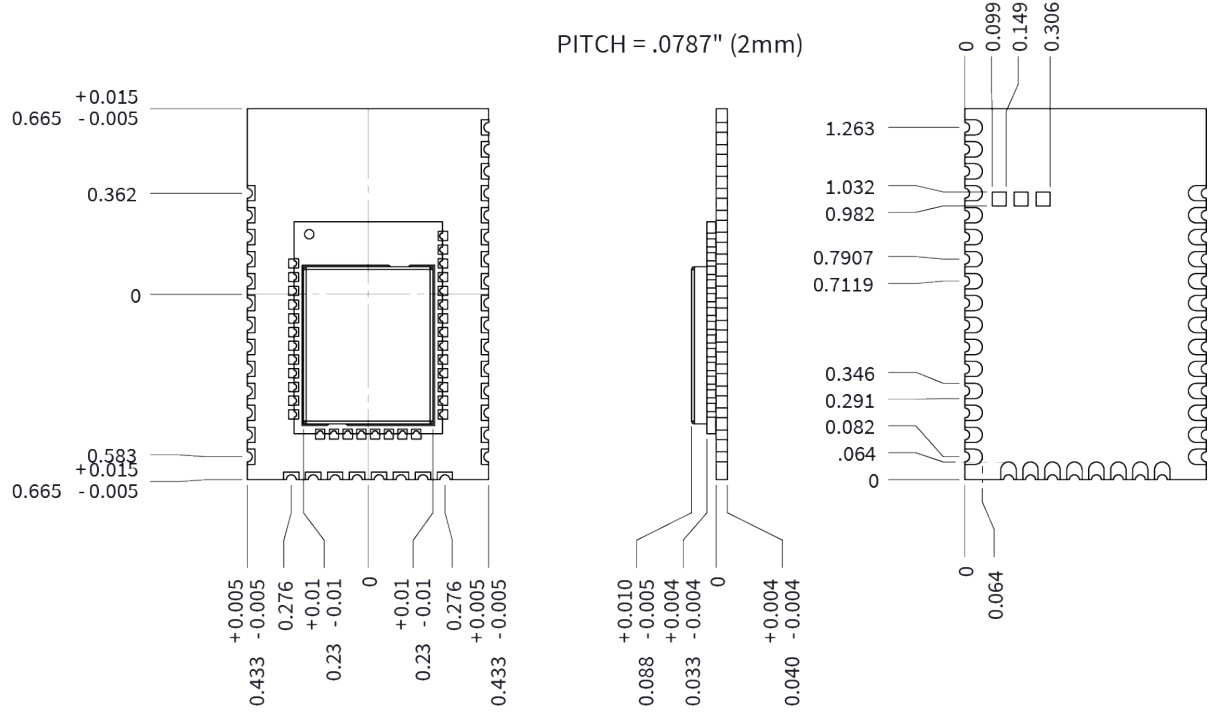

XBee3 micro antennas

The following mechanical drawings are for the XBee3 micro antennas.

XBee3 micro (U.FL/RF Pad)

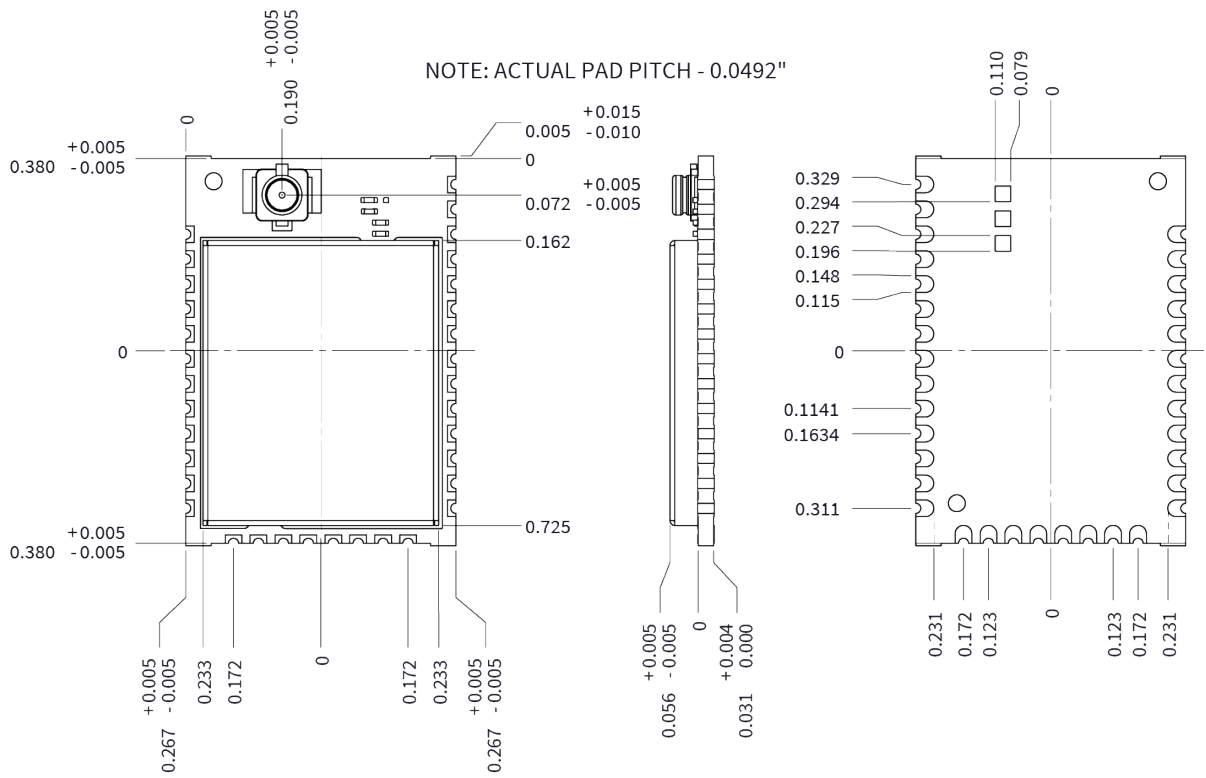

XBee3 micro (chip antenna)

NOTE: ACTUAL PAD PITCH - 0.0492"

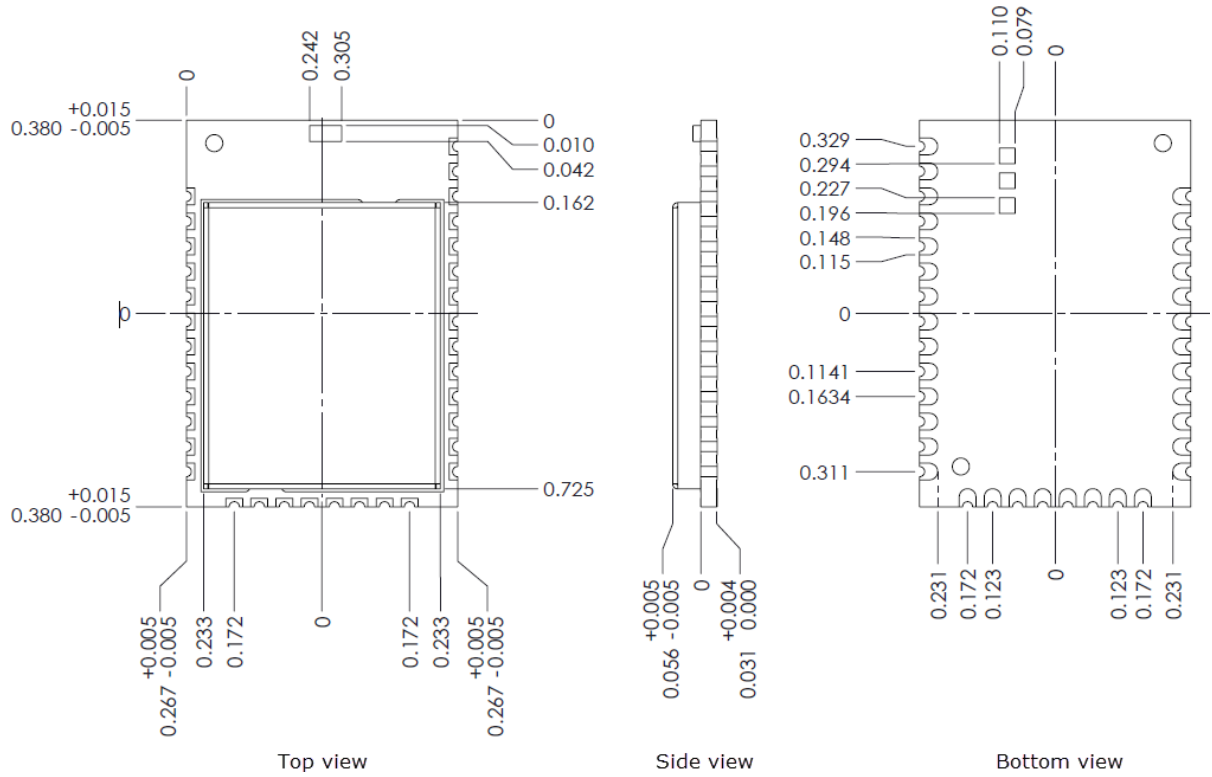

XBee3 through-hole antennas

The following mechanical drawings are for the XBee3 through-hole antennas.

XBee3 through-hole - PCB antenna

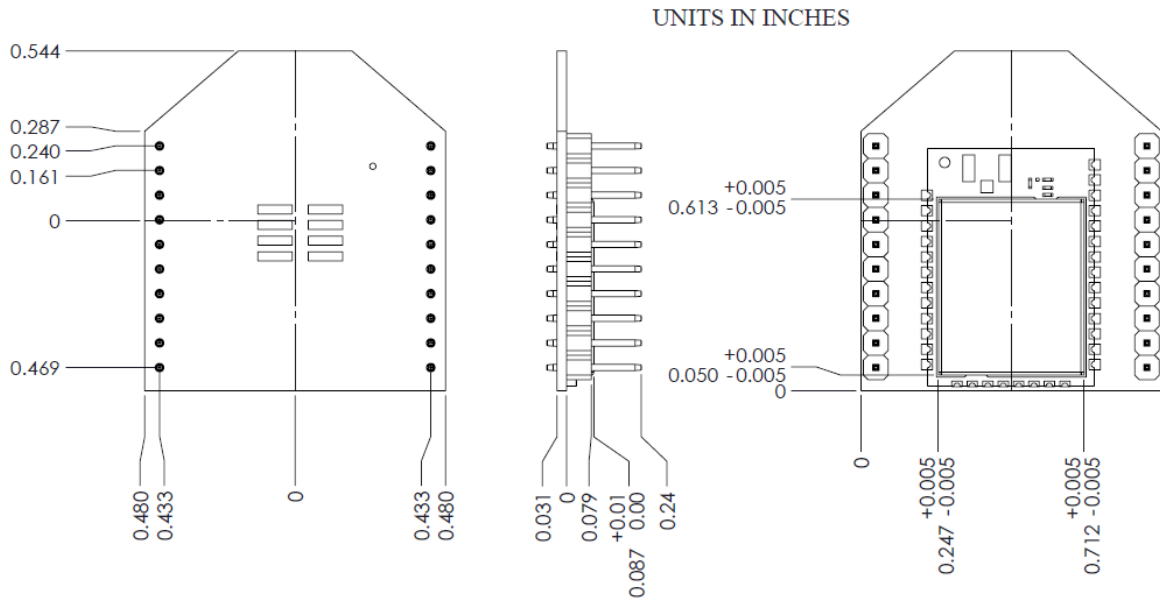

XBee3 through-hole - U.FL antenna

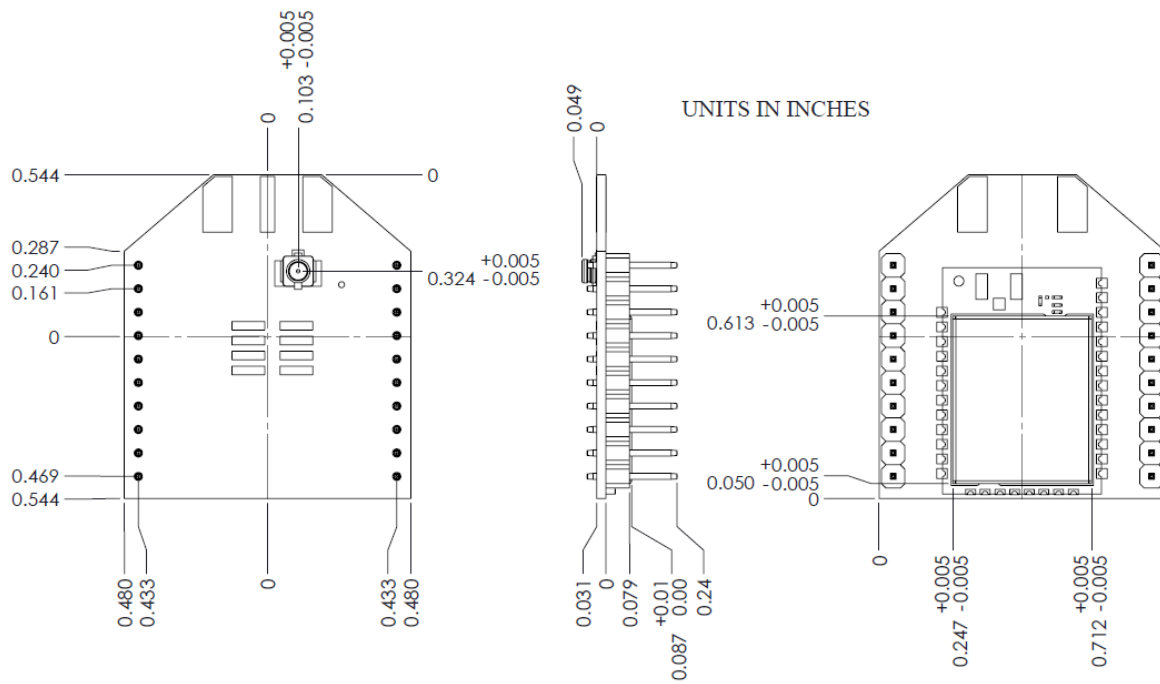

XBee3 through-hole - RPSMA antenna

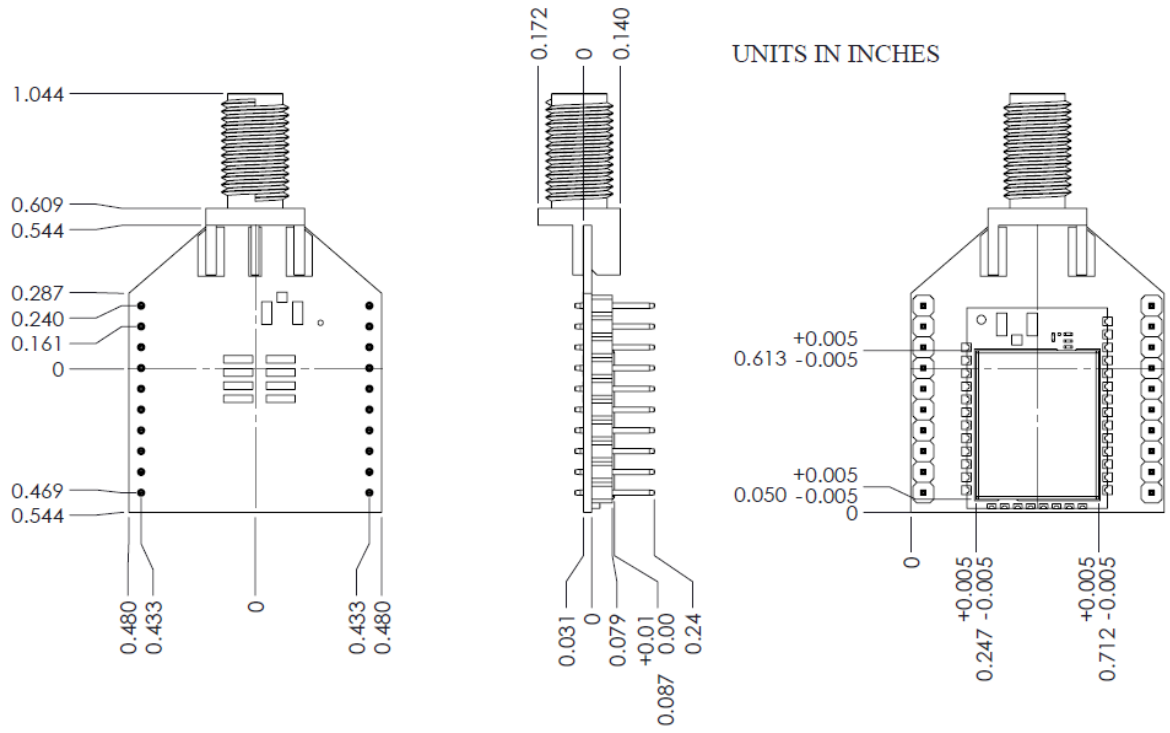

Pin signals

Pin signals for the XBee3 surface-mount module	23
Pin signals for the XBee3 micro module	26
Pin signals for the XBee3 through-hole module	29
Recommended pin connections	30

Pin signals for the XBee3 surface-mount module

The following drawing shows the surface-mount (SMT) pin locations.

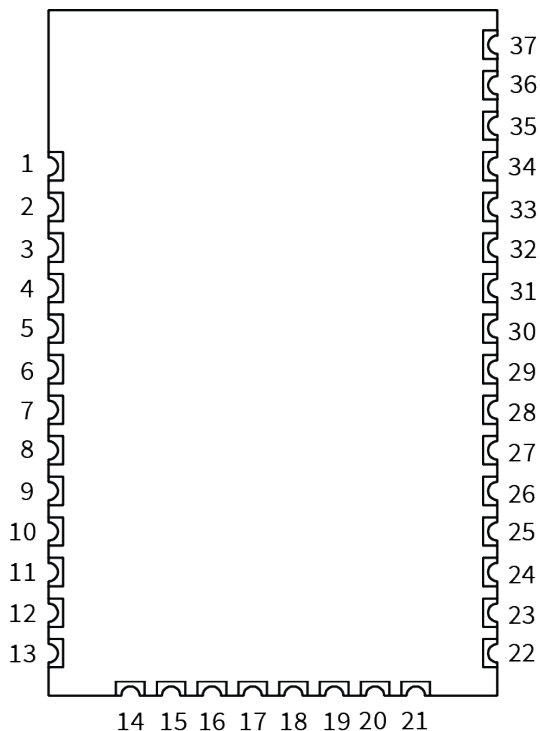

The following table shows the pin signals and their descriptions for the surface-mount device.

Pin#	Name	Direction	Default state	Description
1	GND	-	-	Ground.
2	VCC	-	-	Power supply.
3	DOUT /DIO13	Both	Output	UART data out /GPIO.
4	DIN / $\overline{\text{CONFIG}}$ /DIO14	Both	Input	UART data in /GPIO.
5	DIO12	Both		GPIO.
6	$\overline{\text{RESET}}$	Input		Device reset.
7	RSSI PWM/DIO10	Both	Output	RX signal strength Indicator /GPIO.
8	PWM1/DIO11/I2C SDA	Both	Disabled	Pulse width modulator/GPIO/I2C SDA.
9	[reserved]	-	Disabled	Do not connect.

Pin#	Name	Direction	Default state	Description
10	$\overline{\text{DTR/SLEEP_RQ}}$ /DIO8	Both	Input	Pin sleep control Line/GPIO.
11	GND	-	-	Ground.
12	$\overline{\text{SPI_ATTN/}}$ $\overline{\text{BOOTMODE}}$ /DIO19	Output	Output	Serial peripheral interface attention . Do not tie low on reset.
13	GND	-	-	Ground.
14	SPI_CLK /DIO18	Input	Input	Serial peripheral interface clock/GPIO.
15	$\overline{\text{SPI_SSEL}}$ /DIO17	Input	Input	Serial peripheral interface not select/GPIO.
16	SPI_MOSI/DIO16	Input	Input	Serial peripheral interface data in/GPIO.
17	SPI_MISO/DIO15	Output	Output	Serial peripheral interface data out/GPIO.
18	[reserved]	-	Disabled	Do not connect.
19	[reserved]	-	Disabled	Do not connect.
20	[reserved]	-	Disabled	Do not connect.
21	[reserved]	-	Disabled	Do not connect.
22	GND	-	-	Ground.
23	[reserved]	-	Disabled	Do not connect.
24	DIO4	Both	Disabled	GPIO.
25	$\overline{\text{CTS}}$ /DIO7	Both	Output	Clear to send flow control/GPIO.
26	$\overline{\text{ON/SLEEP}}$ /DIO9	Both	Output	Device status indicator/GPIO
27	[reserved]	-	Disabled	Do not connect or connect to Ground.

Pin#	Name	Direction	Default state	Description
28	ASSOCIATE/DIO5	Both	Output	Associate Indicator/GPIO.
29	$\overline{\text{RTS}}$ /DIO6	Both	Input	Request to send flow control /GPIO.
30	AD3/DIO3	Both	Disabled	Analog input/GPIO.
31	AD2/DIO2	Both	Disabled	Analog input/GPIO
32	AD1/DIO1/I2C SCL	Both	Disabled	Analog input/GPIO/I2C SCL.
33	AD0 /DIO0	Both	Input	Analog input / GPIO / Commissioning button.
34	[reserved]	-	Disabled	Do not connect.
35	GND	-	-	Ground.
36	RF	Both	-	RF I/O for RF pad variant.
37	[reserved]	-	Disabled	Do not connect.
<p>Signal direction is specified with respect to the device. This is a complete list of functionalities. See the applicable software manual for available functionalities.</p>				
<hr/> <p>Note There are a possible three RF test points located on the bottom of the device. Do not connect these test points. For more information, see Recommended footprint.</p> <hr/> <p>See Design notes for details on pin connections.</p>				

Pin signals for the XBee3 micro module

The following drawing shows the micro pin locations.

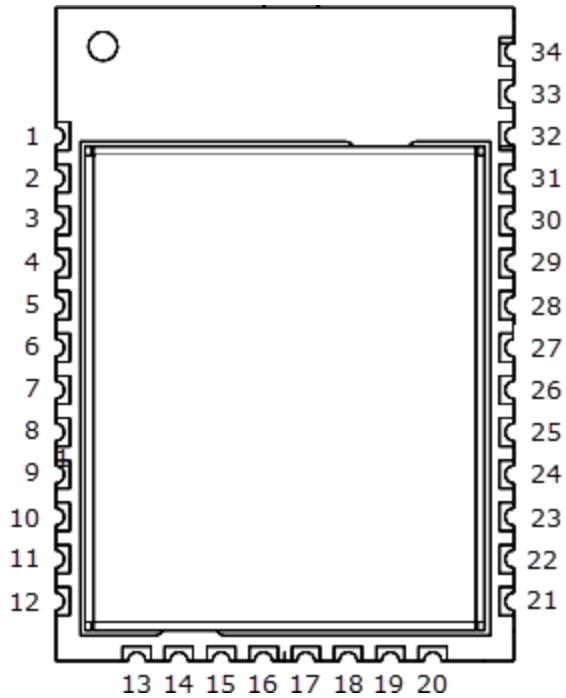

The following table shows the pin signals and their descriptions for the XBee3 Micro device.

Pin#	Name	Direction	Default state	Description
1	GND	-	-	Ground.
2	VCC	-	-	Power supply.
3	DOUT /DIO13	Both	Output	UART data out /GPIO.
4	DIN / CONFIG /DIO14	Both	Input	UART data in /GPIO.
5	DIO12	Both		GPIO.
6	RESET	Input		Device reset.
7	RSSI PWM/DIO10	Both	Output	RX signal strength Indicator /GPIO.
8	PWM1/DIO11/I2C SDA	Both	Disabled	Pulse width modulator/GPIO/I2C SDA.
9	DTR/SLEEP_RQ /DIO8	Both	Input	Pin sleep control Line/GPIO.

Pin#	Name	Direction	Default state	Description
10	GND	-	-	Ground.
11	SPI_ $\overline{\text{ATTN}}$ / $\overline{\text{BOOTMODE}}$ /DIO19	Output	Output	Serial peripheral interface attention Do not tie low on reset.
12	GND	-	-	Ground.
13	SPI_CLK /DIO18	Input	Input	Serial peripheral interface clock/GPIO.
14	SPI_ $\overline{\text{SSEL}}$ /DIO17	Input	Input	Serial peripheral interface not select/GPIO.
15	SPI_MOSI/DIO16	Input	Input	Serial peripheral interface data in/GPIO.
16	SPI_MISO/DIO15	Output	Output	Serial peripheral interface data out/GPIO.
17	[reserved]	-	Disabled	Do not connect.
18	[reserved]	-	Disabled	Do not connect.
19	[reserved]	-	Disabled	Do not connect.
20	[reserved]	-	Disabled	Do not connect.
21	GND	-	-	Ground.
22	[reserved]	-	Disabled	Do not connect.
23	DIO4	Both	Disabled	GPIO.
24	$\overline{\text{CTS}}$ /DIO7	Both	Output	Clear to send flow control/GPIO.
25	ON/ $\overline{\text{SLEEP}}$ /DIO9	Both	Output	Device status indicator/GPIO.
26	ASSOCIATE/DIO5	Both	Output	Associate Indicator/GPIO.
27	$\overline{\text{RTS}}$ /DIO6	Both	Input	Request to send flow control /GPIO.
28	AD3/DIO3	Both	Disabled	Analog input/GPIO.

Pin#	Name	Direction	Default state	Description
29	AD2/DIO2	Both	Disabled	Analog input/GPIO.
30	AD1/DIO1/I2C SCL	Both	Disabled	Analog input/GPIO/I2C SCL.
31	AD0 /DIO0	Both	Input	Analog input / GPIO / Commissioning button.
32	GND	-	-	Ground.
33	RF	Both	-	RF I/O for RF pad variant.
34	GND	-	-	Ground.
<p>Signal direction is specified with respect to the device. This is a complete list of functionalities. See the applicable software manual for available functionalities.</p> <hr/> <p>Note There are three RF test points located on the bottom of the device. Do not connect these test points. For more information, see Recommended footprint.</p> <hr/> <p>See Design notes for details on pin connections.</p> <hr/> <p>* The I2C functionality will be software enabled in a future release.</p>				

Pin signals for the XBee3 through-hole module

The following drawing shows the through-hole pin locations.

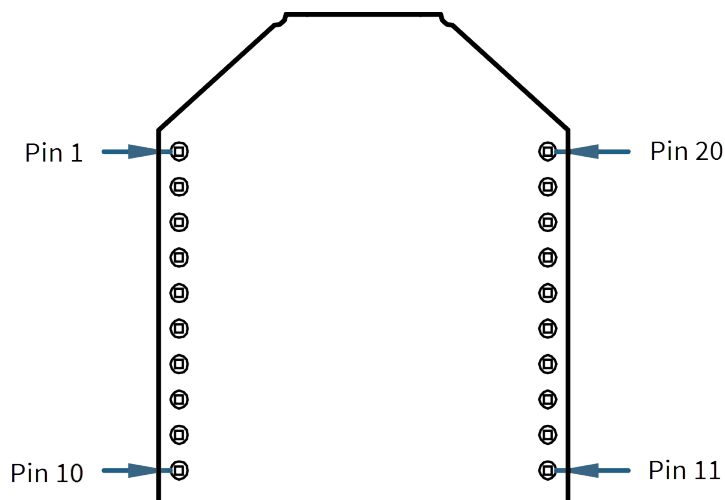

(Top view)

The following table shows the pin signals and their descriptions for the XBee3 though-hole device.

Pin#	Name	Direction	Default state	Description
1	VCC	-	-	Power supply.
2	DOUT/DIO13	Both	Output	UART data out/GPIO.
3	DIN/CONFIG/DIO14	Both	Intput	UART data in/GPIO.
4	DIO12/SPI_MISO	Both	-	GPIO/SPI data out.
5	RESET	Input	-	Device reset.
6	RSSI PWM/DIO10	Both	Output	RX signal Indicator strength/GPIO.
7	PWM1/DIO11/I2C SDA	Both	Disabled	Pulse width modulator/GPIO/I2C SDA.
8	[reserved]	-	Disabled	Do not connect.
9	DTR/SLEEP_RQ/DIO8	Both	Input	Pin sleep control Line/GPIO.
10	GND	-	-	Ground.

Pin#	Name	Direction	Default state	Description
11	DIO4/SPI_MOSI	Both	Disabled	GPIO/Serial peripheral interface data in.
12	$\overline{\text{CTS}}$ /DIO7	Both	Output	Clear to send flow control/GPIO.
13	ON/SLEEP/DIO9	Both	Output	Device status indicator/GPIO.
14	[reserved]	-	Disabled	Do not connect or connect to Ground.
15	ASSOCIATE/DIO5	Both	Output	Associate Indicator/GPIO.
16	$\overline{\text{RTS}}$ /DIO6	Both	Input	Request to send flow control/GPIO.
17	AD3/DIO3/SPI_ $\overline{\text{SSEL}}$	Both	Disabled	Analog input/GPIO/SPI not select.
18	AD2/DIO2/SPI_CLK	Both	Disabled	Analog input/GPIO/SPI clock.
19	AD1/DIO1/SPI_ $\overline{\text{ATTN}}$ /I2C SCL	Both	Disabled	Analog input/GPIO/SPI attention/I2C SCL.
20	AD0 /DIO0	Both	Input	Analog input/GPIO/Commissioning button.
<p>Signal direction is specified with respect to the device. This is a complete list of functionalities. See the applicable software manual for available functionalities. See Design notes for details on pin connections.</p>				
<p>* The I2C functionality will be software enabled in a future release.</p>				

Recommended pin connections

The only required pin connections for two-way communication are VCC, GND, DOUT and DIN. To support serial firmware updates and recovery, you must connect VCC, GND, DOUT, DIN, RTS, and DTR. For applications that need to ensure the lowest sleep current, never leave unconnected inputs floating. Use internal or external pull-up or pull-down resistors, or set the unused I/O lines to outputs.

Design notes

XBee3 modules do not require any external circuitry or specific connections for proper operation. However, there are some general design guidelines that we recommend to build and troubleshoot a robust design.

Power supply design	32
Board layout	32
Antenna performance	32
Design notes for PCB antenna and chip antenna devices	33
Design notes for RF pad devices	35
Copper keepout for test points	38

Power supply design

A poor power supply can lead to poor device performance, especially if you do not keep the supply voltage within tolerance or if it is excessively noisy. To help reduce noise, place a 1.0 μF and 8.2 pF capacitor as near as possible to the VCC connection on the XBee3 (pad 2 for micro and surface-mount, and pin 1 for through-hole). Adding a 10 μF decoupling capacitor is also recommended. If you are using a switching regulator for the power supply, switch the frequencies above 500 kHz. Limit the power supply ripple to a maximum 50 mV peak to peak. For best results, place the lower capacitance capacitors closest to the XBee3 device.

Note XBee3 parts with an early revision of the microcontroller unit (MCU) may experience an issue recovering from brownouts under rare conditions. See [Brownout issue](#) for details on how to avoid this issue.

Board layout

We design XBee3 modules to be self-sufficient and have minimal sensitivity to nearby processors, crystals or other printed circuit board (PCB) components. Keep power and ground traces thicker than signal traces and make sure that they are able to comfortably support the maximum current specifications. There are no other special PCB design considerations to integrate XBee3 modules, with the exception of antennas.

Antenna performance

Antenna location is important for optimal performance. The following suggestions help you achieve optimal antenna performance. Point the antenna up vertically (upright). Antennas radiate and receive the best signal perpendicular to the direction they point, so a vertical antenna's omnidirectional radiation pattern is strongest across the horizon.

Position the antennas away from metal objects whenever possible. Metal objects between the transmitter and receiver can block the radiation path or reduce the transmission distance. Objects that are often overlooked include:

- Metal poles
- Metal studs
- Structure beams
- Concrete, which is usually reinforced with metal rods

If you place the device inside a metal enclosure, use an external antenna. Common objects that have metal enclosures include:

- Vehicles
- Elevators
- Ventilation ducts
- Refrigerators
- Microwave ovens
- Batteries
- Tall electrolytic capacitors

Use the following additional guidelines for optimal antenna performance:

- Do not place XBee3 modules with the chip antenna or the embedded antenna inside a metal enclosure.
- Do not place any ground planes or metal objects above or below the antenna.
- For the best results, mount the device at the edge of the host PCB. Ensure that the ground, power, and signal planes are vacant immediately below the antenna section.

Design notes for PCB antenna and chip antenna devices

Position PCB/chip antenna devices so there are no ground planes or metal objects above or below the antenna. For best results, do not place the device in a metal enclosure, as this may greatly reduce the range. Place the device at the edge of the PCB on which it is mounted. Make sure the ground, power and signal planes are vacant immediately below the antenna section.

The following drawings illustrate important recommendations when you are designing with PCB/chip antenna devices. For optimal performance on the surface-mount device, do not mount the device on the RF pad footprint described in the next section, because the footprint requires a ground plane within the PCB antenna keepout area.

Surface-mount embedded antenna keepout area

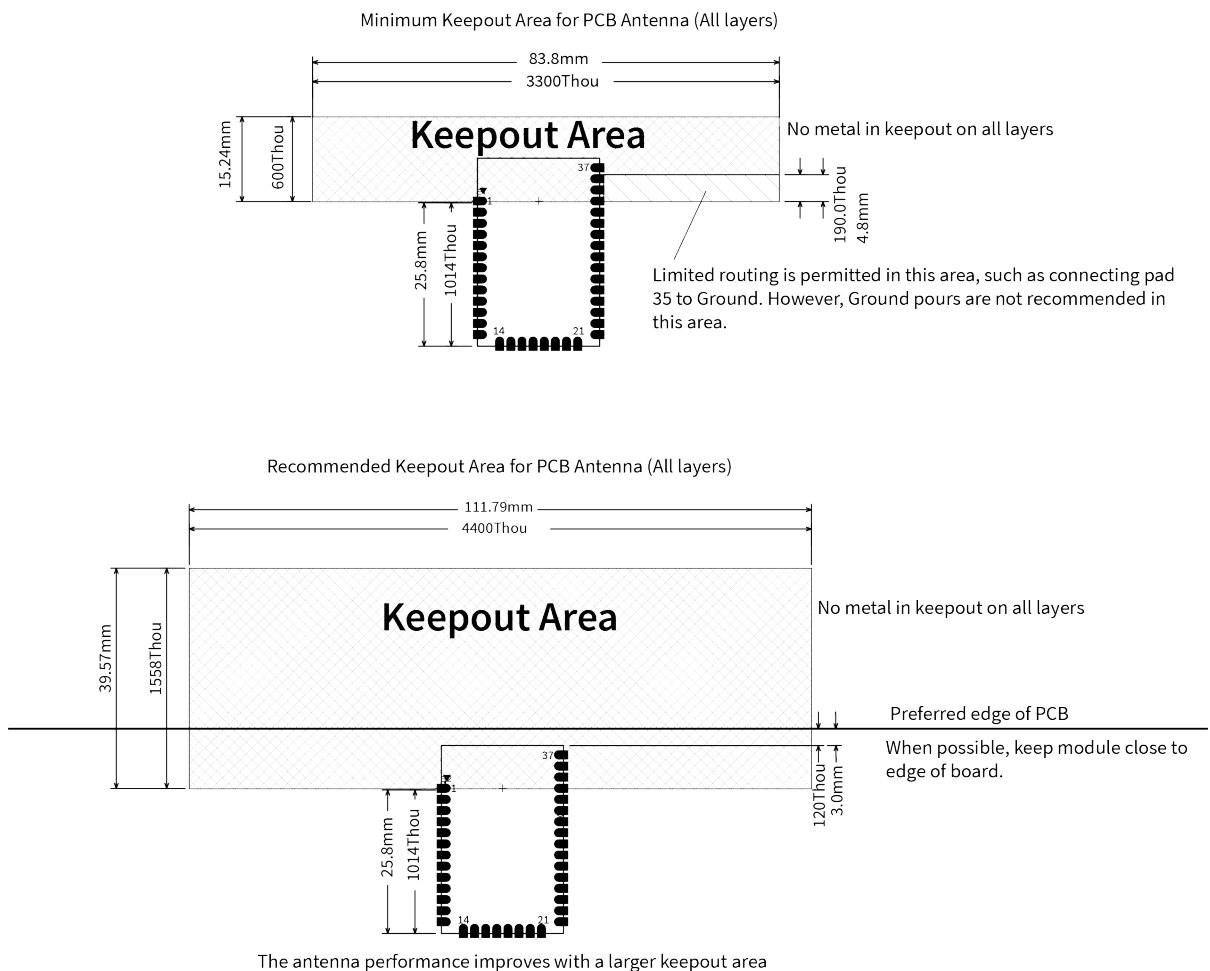

Notes

1. We recommend non-metal enclosures. For metal enclosures, use an external antenna.
2. Keep metal chassis or mounting structures in the keepout area at least 2.54 cm (1 in) from the antenna.
3. Maximize the distance between the antenna and metal objects that might be mounted in the keepout area.
4. These keepout area guidelines do not apply for chip antennas or external RF connectors.

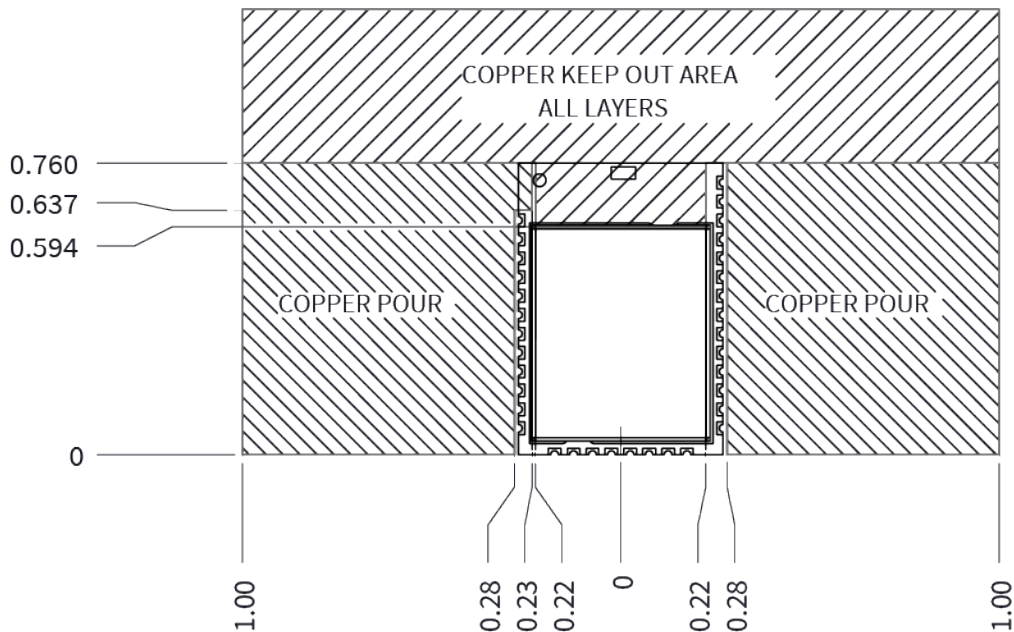
XBee3 Micro chip antenna keepout area**Notes**

1. We recommend non-metal enclosures. For metal enclosures, use an external antenna.
2. Keep metal chassis or mounting structures in the keepout area at least 2.54 cm (1 in) from the antenna.
3. Maximize the distance between the antenna and metal objects that might be mounted in the keepout area.
4. Neither a copper pour nor a copper keepout is necessary under the shield area for proper antenna functionality. It is still necessary to follow the recommendations in [Recommended footprint](#) for the PCB layout.
5. These keepout area guidelines do not apply for surface-mount embedded antennas or external RF connectors.

Through-hole embedded antenna keepout area

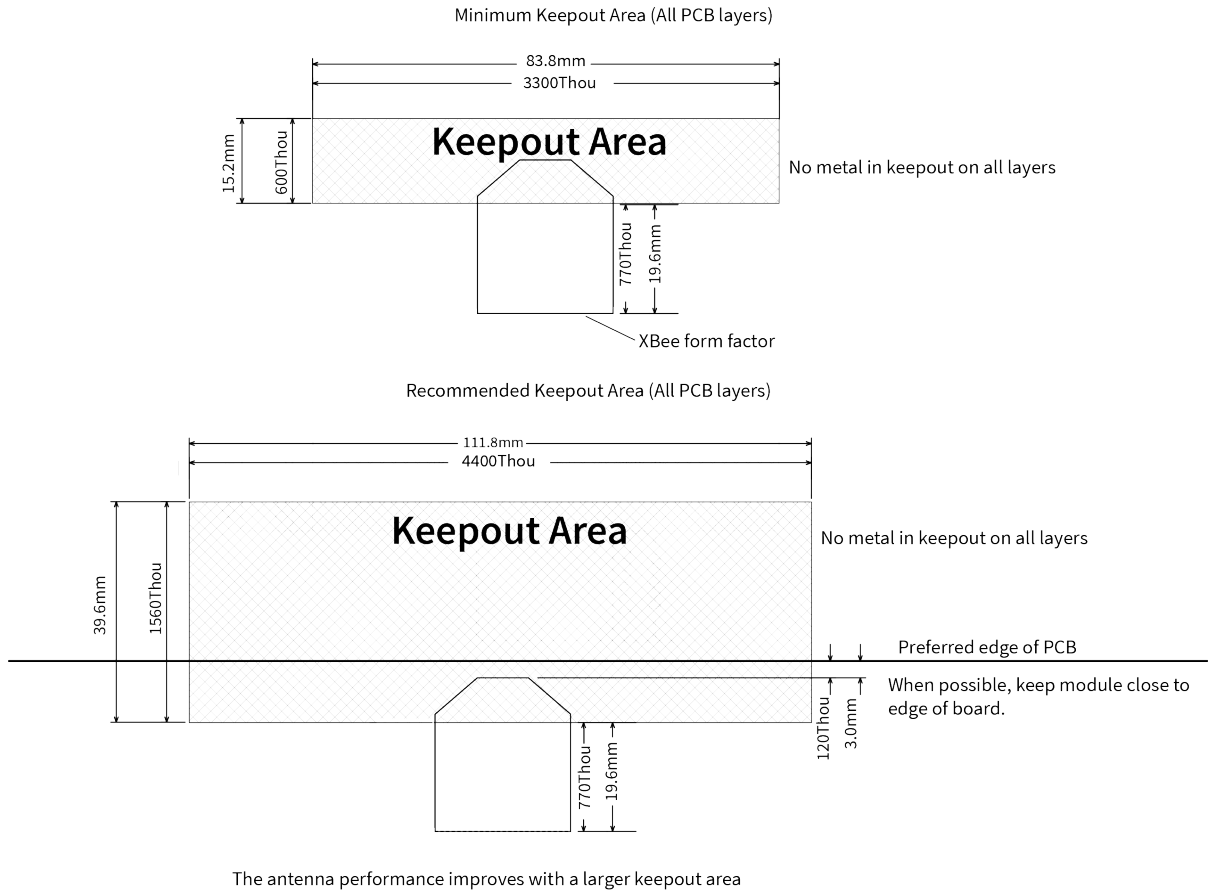

Notes

1. We recommend non-metal enclosures. For metal enclosures, use an external antenna.
2. Keep metal chassis or mounting structures in the keepout area at least 2.54 cm (1 in) from the antenna.
3. Maximize the distance between the antenna and metal objects that might be mounted in the keepout area.
4. These keepout area guidelines do not apply for external RF connectors.

Design notes for RF pad devices

The RF pad is a soldered antenna connection. The RF signal travels from the RF pad connection (pad 33 on micro modules and pad 36 on surface-mount modules) on the device to the antenna through an RF trace transmission line on the PCB. Any additional components between the device and antenna violates modular certification. The controlled impedance for the RF trace is 50 Ω.

We recommend using a microstrip trace, although you can also use a coplanar waveguide if you need more isolation. A microstrip generally requires less area on the PCB than a coplanar waveguide. We do not recommend using a stripline because sending the signal to different PCB layers can introduce matching and performance problems.

Following good design practices is essential when implementing the RF trace on a PCB. Consider the following points:

- Minimize the length of the trace by placing the RPSMA jack close to the device.
- Connect all of the grounds on the jack and the device to the ground planes directly or through closely placed vias.
- Space any ground fill on the top layer at least twice the distance d , for Micro modules at least 0.028" and for surface mount modules at least 0.050".

Additional considerations:

- The top two layers of the PCB have a controlled thickness dielectric material in between.
- The second layer has a ground plane which runs underneath the entire RF pad area. This ground plane is a distance d , the thickness of the dielectric, below the top layer.
- The RF trace width determines the impedance of the transmission line with relation to the ground plane. Many online tools can estimate this value, although you should consult the PCB manufacturer for the exact width.

Implementing these design suggestions helps ensure that the RF pad device performs to its specifications.

The following figures show a layout example of a host PCB that connects an RF pad device to a right angle, through-hole RPSMA jack.

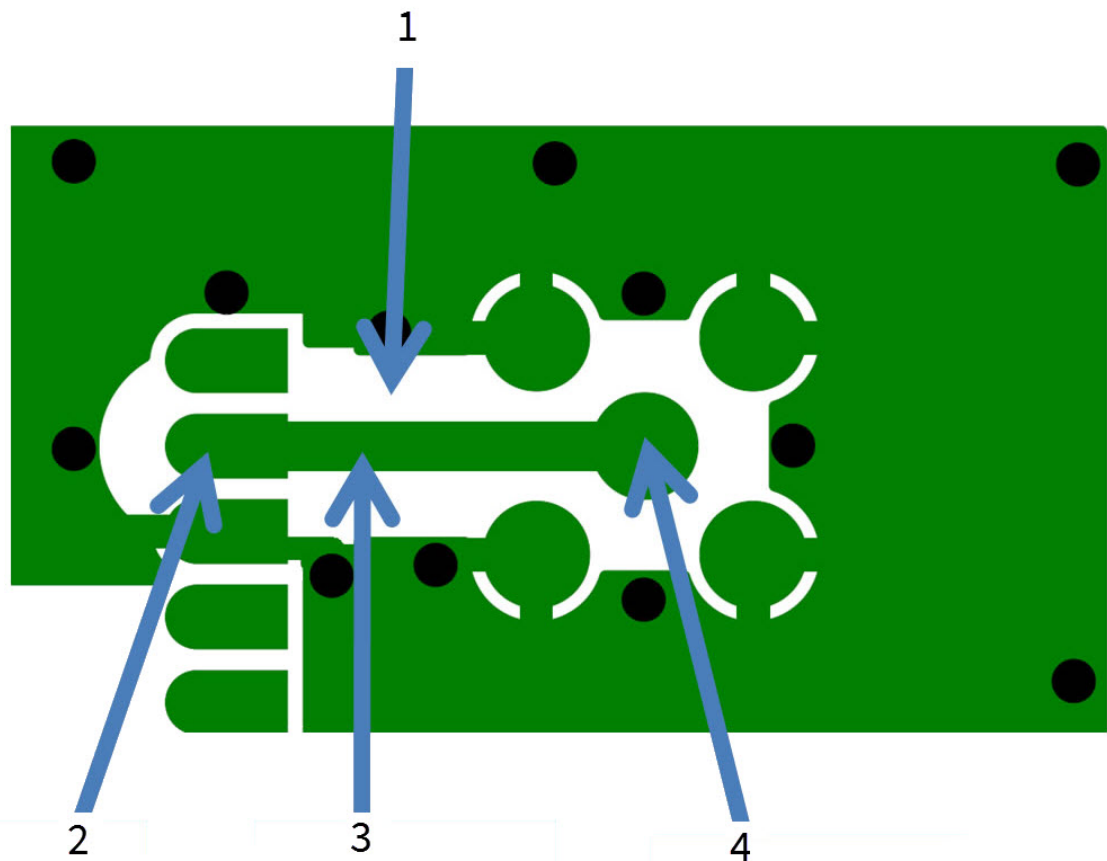

Number	Description
1	Maintain a distance of at least 2 d between microstrip and ground fill.
2	RF pad pin.
3	50 Ω microstrip trace.
4	RF connection of RPSMA jack.

This example is on a surface-mount device. The width in this example is approximately 0.045" for a 50 Ω trace, assuming $d=0.025"$, and that the dielectric has a relative permittivity of 4.4. This trace width is a good fit with the device footprint's 0.060" pad width.

Note We do not recommend using a trace wider than the pad width, and using a very narrow trace (under 0.010") can cause unwanted RF loss.

The following illustration shows PCB layer 2 of an example RF layout.

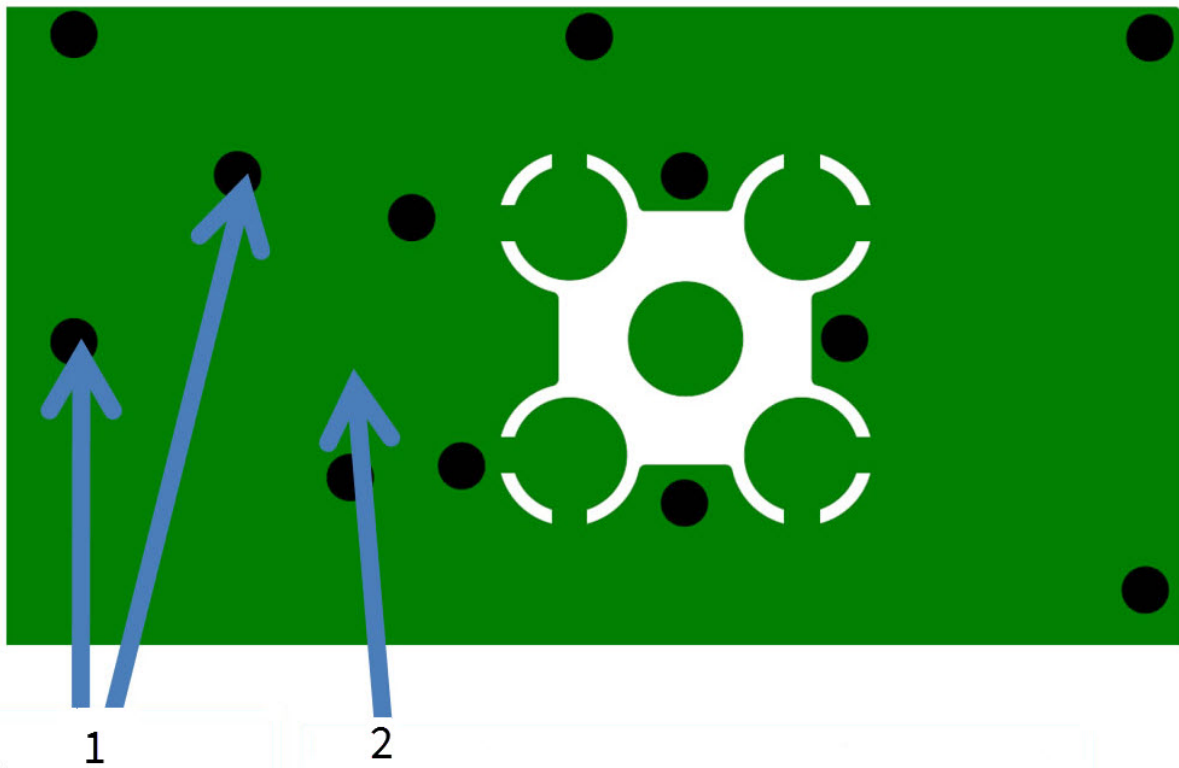

Number	Description
1	Use multiple vias to help eliminate ground variations.
2	Put a solid ground plane under RF trace to achieve the desired impedance.

Copper keepout for test points

The following keepouts are required for all surface-mount or micro-mount devices. These keepouts are in addition to the other keepouts if using a PCB or chip antenna.

While the underside of the device is mostly coated with solder resist, we recommended the copper layer directly below the device be left open to avoid unintended contacts. Copper or vias must not interfere with the three exposed RF test points on the bottom of the device as shown in the following diagrams. These devices have a ground plane in the middle on the back side for shielding purposes, which can be affected by copper traces directly below the device.

Copper keepout for the XBee3 surface-mount

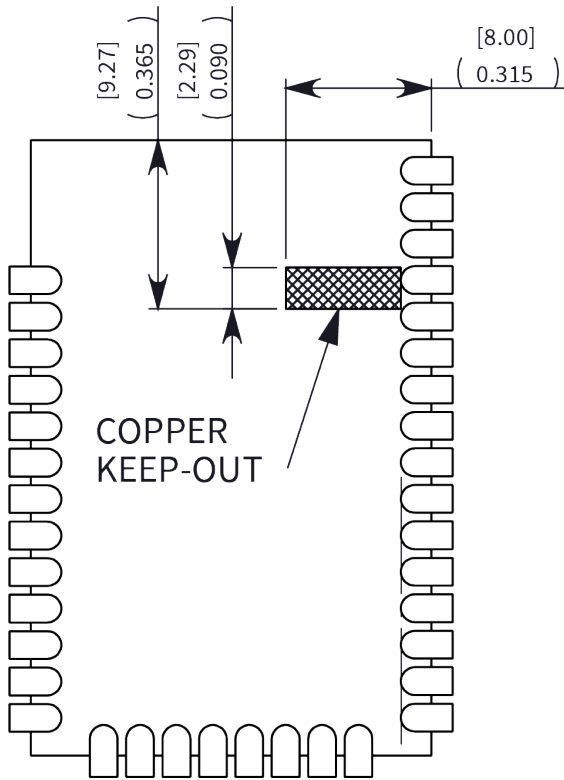

Copper keepout for the XBee3 Micro

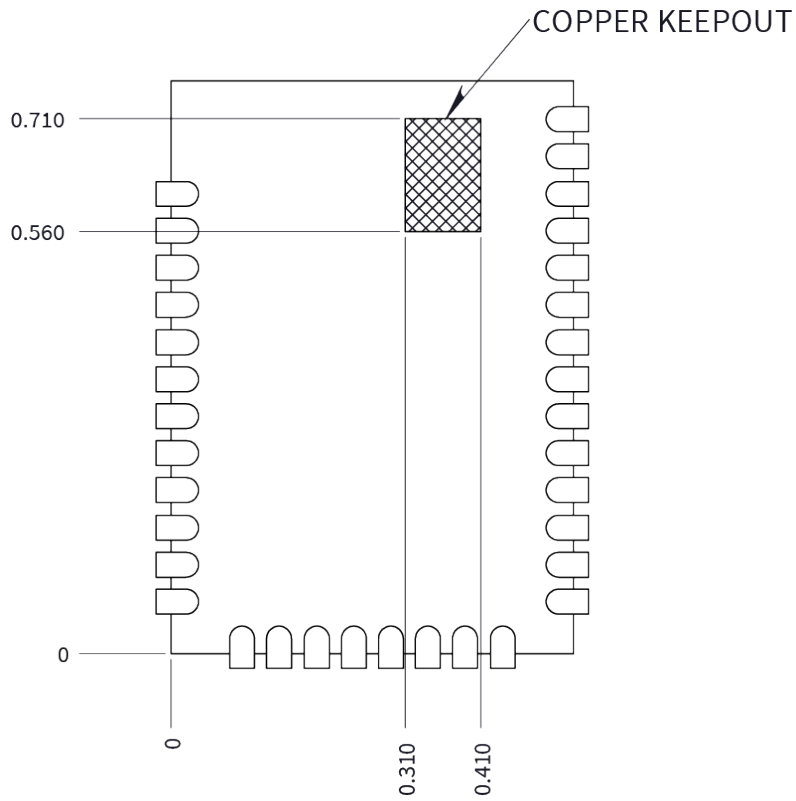

Regulatory information

United States (FCC)	41
Europe (CE)	51
ISED (Innovation, Science and Economic Development Canada)	53
Australia (RCM)/New Zealand	54
Japan (TELEC)	54
Brazil ANATEL	54
South Korea	55

United States (FCC)

XBee3 RF Modules comply with Part 15 of the FCC rules and regulations. Compliance with the labeling requirements, FCC notices and antenna usage guidelines is required.

To fulfill FCC Certification, the OEM must comply with the following regulations:

1. The system integrator must ensure that the text on the external label provided with this device is placed on the outside of the final product.
2. RF Modules may only be used with antennas that have been tested and approved for use with the modules.

OEM labeling requirements



WARNING! As an Original Equipment Manufacturer (OEM) you must ensure that FCC labeling requirements are met. You must include a clearly visible label on the outside of the final product enclosure that displays the following content:

Required FCC Label for OEM products containing the XBee3 RF Module

Contains FCC ID: MCQ-XBEE3

This device complies with Part 15 of the FCC Rules. Operation is subject to the following two conditions: (1.) this device may not cause harmful interference and (2.) this device must accept any interference received, including interference that may cause undesired operation.

FCC notices

IMPORTANT: XBee3 RF Modules have been certified by the FCC for use with other products without any further certification (as per FCC section 2.1091). Modifications not expressly approved by Digi could void the user's authority to operate the equipment.

IMPORTANT: OEMs must test final product to comply with unintentional radiators (FCC section 15.107 & 15.109) before declaring compliance of their final product to Part 15 of the FCC Rules.

IMPORTANT: The RF module has been certified for remote and base radio applications. If the module will be used for portable applications, the device must undergo SAR testing.

This equipment has been tested and found to comply with the limits for a Class B digital device, pursuant to Part 15 of the FCC Rules. These limits are designed to provide reasonable protection against harmful interference in a residential installation. This equipment generates, uses and can radiate radio frequency energy and, if not installed and used in accordance with the instructions, may cause harmful interference to radio communications. However, there is no guarantee that interference will not occur in a particular installation.

If this equipment does cause harmful interference to radio or television reception, which can be determined by turning the equipment off and on, the user is encouraged to try to correct the interference by one or more of the following measures: Re-orient or relocate the receiving antenna, Increase the separation between the equipment and receiver, Connect equipment and receiver to outlets on different circuits, or Consult the dealer or an experienced radio/TV technician for help.

FCC-approved antennas (2.4 GHz)

The XBee3 RF Module can be installed using antennas and cables constructed with non-standard connectors (RPSMA, RPTNC, etc.) An adapter cable may be necessary to attach the XBee connector to the antenna connector.

The modules are FCC approved for fixed base station and mobile applications for the channels indicated in the tables below. If the antenna is mounted at least 20 cm (7.87 in) from nearby persons, the application is considered a mobile application. Antennas not listed in the table must be tested to comply with FCC Section 15.203 (Unique Antenna Connectors) and Section 15.247 (Emissions).

The antennas in the tables below have been approved for use with this module. Cable loss is required when using gain antennas as shown in the tables.

Digi does not carry all of these antenna variants. Contact Digi Sales for available antennas.

1. If using the RF module in a portable application (for example, if the module is used in a hand-held device and the antenna is less than 20 cm from the human body when the device is in operation), The integrator is responsible for passing additional Specific Absorption Rate (SAR) testing based on FCC rules 2.1091 and FCC Guidelines for Human Exposure to Radio Frequency Electromagnetic Fields, OET Bulletin and Supplement C. The testing results will be submitted to the FCC for approval prior to selling the integrated unit. The required SAR testing measures emissions from the module and how they affect the person.

XBee3 RF module

The following table shows the antennas approved for use with the XBee3 RF module.

All antenna part numbers followed by an asterisk (*) are not available from Digi. Consult with an antenna manufacturer for an equivalent option.

Part number	Type (description)	Gain (dBi)	Application*	Min. separation	Required antenna cable loss (dB)	
					802.15.4 Based Protocols (Ex: Zigbee)	Bluetooth low energy technology (when available)
Integral antennas						
29000313	Integral PCB antenna (surface-mount only)	0.0	Fixed/Mobile	20 cm	N/A	N/A
29000710	Chip antenna (micro only)	0.0	Fixed/Mobile	20 cm	N/A	N/A
29000294	Integral PCB antenna (through-hole only)	-0.5 dBi	Fixed/Mobile	20 cm	N/A	N/A
Dipole antennas						
31000019-01	Integral Dipole (USB Adapter Only)	0.87	Portable	N/A	N/A	N/A
A24-HASM-450	Dipole (Half-wave articulated RPSMA - 4.5")	2.1	Fixed	20 cm	N/A	N/A
A24-HABSM*	Dipole (Articulated RPSMA)	2.1	Fixed	20 cm	N/A	N/A
29000095	Dipole (Half-wave articulated RPSMA - 4.5")	2.1	Fixed/Mobile	20 cm	N/A	N/A
A24-HABUF-P5I	Dipole (Half-wave articulated bulkhead mount U.FL. w/ 5" pigtail)	2.1	Fixed/Mobile	20 cm	N/A	N/A
A24-HASM-525	Dipole (Half-wave articulated RPSMA - 5.25")	2.1	Fixed	20 cm	N/A	N/A

Part number	Type (description)	Gain (dBi)	Application*	Min. separation	Required antenna cable loss (dB)	
					802.15.4 Based Protocols (Ex: Zigbee)	Bluetooth low energy technology (when available)
Omni-directional (Collinear Dipole Array) antennas						
A24-F2NF	Omni-directional (Fiberglass base station)	2.1	Fixed/Mobile	20 cm	N/A	N/A
A24-F3NF	Omni-directional (Fiberglass base station)	3.0	Fixed/Mobile	20 cm	N/A	N/A
A24-F5NF	Omni-directional (Fiberglass base station)	5.0	Fixed	20 cm	N/A	N/A
A24-F8NF	Omni-directional (Fiberglass base station)	8.0	Fixed	2 m	N/A	N/A
A24-F9NF	Omni-directional (Fiberglass base station)	9.5	Fixed	2 m	N/A	N/A
A24-F10NF	Omni-directional (Fiberglass base station)	10.0	Fixed	2 m	N/A	N/A
A24-F12NF	Omni-directional (Fiberglass base station)	12.0	Fixed	2 m	N/A	N/A
A24-W7NF	Omni-directional (Fiberglass base station)	7.2	Fixed	2 m	N/A	N/A
A24-M7NF	Omni-directional (Mag-mount base station)	7.2	Fixed	2 m	N/A	N/A
A24-F15NF	Omni-directional (Fiberglass base station)	15.0	Fixed	2 m	N/A	N/A
Panel antennas						
A24-P8SF	Flat Panel	8.5	Fixed	2 m	N/A	N/A

Part number	Type (description)	Gain (dBi)	Application*	Min. separation	Required antenna cable loss (dB)	
					802.15.4 Based Protocols (Ex: Zigbee)	Bluetooth low energy technology (when available)
A24-P8NF	Flat Panel	8.5	Fixed	2 m	N/A	N/A
A24-P13NF	Flat Panel	13.0	Fixed	2 m	N/A	N/A
A24-P14NF	Flat Panel	14.0	Fixed	2 m	N/A	N/A
A24-P15NF	Flat Panel	15.0	Fixed	2 m	N/A	N/A
A24-P16NF	Flat Panel	16.0	Fixed	2 m	N/A	N/A
A24-P19NF	Flat Panel	19.0	Fixed	2 m	N/A	N/A
Yagi antennas						
A24-Y6NF	Yagi (6-element)	8.8	Fixed	2 m	N/A	N/A
A24-Y7NF	Yagi (7-element)	9.0	Fixed	2 m	N/A	N/A
A24-Y9NF	Yagi (9-element)	10.0	Fixed	2 m	N/A	N/A
A24-Y10NF	Yagi (10-element)	11.0	Fixed	2 m	N/A	N/A
A24-Y12NF	Yagi (12-element)	12.0	Fixed	2 m	N/A	N/A
A24-Y13NF	Yagi (13-element)	12.0	Fixed	2 m	N/A	N/A
A24-Y15NF	Yagi (15-element)	12.5	Fixed	2 m	N/A	N/A
A24-Y16NF	Yagi (16-element)	13.5	Fixed	2 m	N/A	N/A
A24-Y16RM	Yagi (16-element, RPSMA connector)	13.5	Fixed	2 m	N/A	N/A
A24-Y18NF	Yagi (18-element)	15.0	Fixed	2 m	N/A	N/A

XBee3-PRO RF module

The following table shows the antennas approved for use with the XBee3-PRO RF Module.

All antenna part numbers followed by an asterisk (*) are not available from Digi. Consult with an antenna manufacturer for an equivalent option.

Part number	Type (description)	Gain (dBi)	Application*	Min separation	Required antenna cable loss (dB)	
					802.15.4 Based Protocols (Ex: Zigbee)	Bluetooth low energy technology (when available)
Internal antennas						
29000313	Integral PCB antenna (surface mount only)	0.0	Fixed/Mobile	20 cm	N/A	N/A
29000710	Chip antenna (micro only)	0.0	Fixed/Mobile	20 cm	N/A	N/A
29000294	Integral PCB antenna (through-hole only)	-0.5 dBi	Fixed/Mobile	20 cm	N/A	N/A
Dipole antennas						
A24-HASM-450	Dipole (Half-wave articulated RPSMA - 4.5")	2.1	Fixed	20 cm	N/A	N/A
A24-HABSM*	Dipole (Articulated RPSMA)	2.1	Fixed	20 cm	N/A	N/A
29000095	Dipole (Half-wave articulated RPSMA - 4.5")	2.1	Fixed/Mobile	20 cm	N/A	N/A

Part number	Type (description)	Gain (dBi)	Application*	Min separation	Required antenna cable loss (dB)	
					802.15.4 Based Protocols (Ex: Zigbee)	Bluetooth low energy technology (when available)
A24-HABUF-P5I	Dipole (Half-wave articulated bulkhead mount U.F.L. w/ 5" pigtail)	2.1	Fixed/Mobile	20 cm	N/A	N/A
A24-HASM-525	Dipole (Half-wave articulated RPSMA - 5.25")	2.1	Fixed	20 cm	N/A	N/A
Omni-directional (Collinear Dipole Array) antennas						
A24-F2NF	Omni-directional (Fiberglass base station)	2.1	Fixed/Mobile	20 cm	N/A	N/A
A24-F3NF	Omni-directional (Fiberglass base station)	3.0	Fixed/Mobile	20 cm	N/A	N/A
A24-F5NF	Omni-directional (Fiberglass base station)	5.0	Fixed	20 cm	N/A	N/A
A24-F8NF	Omni-directional (Fiberglass base station)	8.0	Fixed	2 m	N/A	N/A
A24-F9NF	Omni-directional (Fiberglass base station)	9.5	Fixed	2 m	N/A	N/A

Part number	Type (description)	Gain (dBi)	Application*	Min separation	Required antenna cable loss (dB)	
					802.15.4 Based Protocols (Ex: Zigbee)	Bluetooth low energy technology (when available)
A24-F10NF	Omni-directional (Fiberglass base station)	10	Fixed	2 m	N/A	N/A
A24-F12NF	Omni-directional (Fiberglass base station)	12	Fixed	2 m	N/A	N/A
A24-W7NF	Omni-directional (Fiberglass base station)	7.2	Fixed	2 m	N/A	N/A
A24-M7NF	Omni-directional (Mag-mount base station)	7.2	Fixed	2 m	N/A	N/A
A24-F15NF	Omni-directional (Fiberglass base station)	15.0	Fixed	2 m	N/A	2.0
Panel antennas						
A24-P8SF	Flat Panel	8.5	Fixed	2 m	N/A	N/A
A24-P8NF	Flat Panel	8.5	Fixed	2 m	N/A	N/A
A24-P13NF	Flat Panel	13.0	Fixed	2 m	N/A	N/A
A24-P14NF	Flat Panel	14.0	Fixed	2 m	N/A	1.0
A24-P15NF	Flat Panel	15.0	Fixed	2 m	N/A	2.0
A24-P16NF	Flat Panel	16.0	Fixed	2 m	N/A	3.0
A24-P19NF	Flat Panel	19.0	Fixed	2 m	3.0	6.0

Part number	Type (description)	Gain (dBi)	Application*	Min separation	Required antenna cable loss (dB)	
					802.15.4 Based Protocols (Ex: Zigbee)	Bluetooth low energy technology (when available)
Yagi antennas						
A24-Y6NF	Yagi (6-element)	8.8	Fixed	2 m	N/A	N/A
A24-Y7NF	Yagi (7-element)	9.0	Fixed	2 m	N/A	N/A
A24-Y9NF	Yagi (9-element)	10.0	Fixed	2 m	N/A	N/A
A24-Y10NF	Yagi (10-element)	11.0	Fixed	2 m	N/A	N/A
A24-Y12NF	Yagi (12-element)	12.0	Fixed	2 m	N/A	N/A
A24-Y13NF	Yagi (13-element)	12.0	Fixed	2 m	N/A	N/A
A24-Y15NF	Yagi (15-element)	12.5	Fixed	2 m	N/A	N/A
A24-Y16NF	Yagi (16-element)	13.5	Fixed	2 m	N/A	0.5
A24-Y16RM	Yagi (16-element, RPSMA connector)	13.5	Fixed	2 m	N/A	0.5
A24-Y18NF	Yagi (18-element)	15.0	Fixed	2 m	N/A	2.0
<p>* If using the RF module in a portable application (for example - if the module is used in a handheld device and the antenna is less than 20 cm from the human body when the device is in operation): The integrator is responsible for passing additional SAR (Specific Absorption Rate) testing based on FCC rules 2.1091 and FCC Guidelines for Human Exposure to Radio Frequency Electromagnetic Fields, OET Bulletin and Supplement C. The testing results will be submitted to the FCC for approval prior to selling the integrated unit. The required SAR testing measures emissions from the module and how they affect the person.</p>						

RF exposure

If you are integrating the XBee3 into another product, you must include the following Caution statement in OEM product manuals to alert users of FCC RF exposure compliance:



CAUTION! To satisfy FCC RF exposure requirements for mobile transmitting devices, a separation distance of 20 cm or more should be maintained between the antenna of this device and persons during device operation. To ensure compliance, operations at closer than this distance are not recommended. The antenna used for this transmitter must not be co-located in conjunction with any other antenna or transmitter.

XBee3 USB Adapter

The XBee3 USB Adapter integrates an XBee3 RF Module into its hardware. Due to output power limitations it is exempt from SAR testing. It is approved as a portable application.

FCC publication 996369 related information

In Publication 996369 section D03, the FCC requires information concerning a module to be presented by OEM manufacturers. This section assists in answering or fulfilling these requirements.

2.1 General

No requirements are associated with this section.

2.2 List of applicable FCC rules

This module conforms to FCC Part 15.247.

2.3 Summarize the specific operational use conditions

Certain approved antennas require attenuation for operation. For the XBee3, see [XBee3 RF module](#). For the Pro XBee3, see [XBee3-PRO RF module](#).

Host product user guides should include the antenna table if end customers are permitted to select antennas.

2.4 Limited module procedures

Not applicable.

2.5 Trace antenna designs

While it is possible to build a trace antenna into the host PCB, this requires at least a Class II permissive change to the FCC grant which includes significant extra testing and cost. If an embedded trace or chip antenna is desired, simply select the XBee3 module variant with the preferred antenna.

2.6 RF exposure considerations

For RF exposure considerations see [RF exposure](#) and [FCC-approved antennas \(2.4 GHz\)](#).

Host product manufacturers need to provide end-users a copy of the “RF Exposure” section of the manual: [RF exposure](#).

2.7 Antennas

A list of approved antennas is provided for the XBee3 product. For the XBee3, see [XBee3 RF module](#). For the Pro XBee3, see [XBee3-PRO RF module](#).

2.8 Label and compliance information

Host product manufacturers need to follow the sticker guidelines outlined in [OEM labeling requirements](#).

2.9 Information on test modes and additional testing requirements

Contact a Digi sales representative for information on how to configure test modes for the XBee3 product.

2.10 Additional testing, Part 15 Subpart B disclaimer

All final host products must be tested to be compliant to FCC Part 15 Subpart B standards. While the XBee3 unit was tested to be compliant to FCC unintentional radiator standards, FCC Part 15 Subpart B compliance testing is still required for the final host product. This testing is required for all end products, and XBee3 Part 15 Subpart B compliance does not affirm the end product's compliance. See [FCC notices](#) for more details.

Europe (CE)

The XBee3 RF Module has been tested for use in several European countries. For a complete list, refer to www.digi.com/resources/certifications.

If XBee3 RF Modules are incorporated into a product, the manufacturer must ensure compliance of the final product with articles 3.1a and 3.1b of the Radio Equipment Directive. A Declaration of Conformity must be issued for each of these standards and kept on file as described in the Radio Equipment Directive.

Furthermore, the manufacturer must maintain a copy of the XBee3 RF Module user guide documentation and ensure the final product does not exceed the specified power ratings, antenna specifications, and/or installation requirements as specified in the user guide.

Maximum power and frequency specifications

For the XBee3 device:

When using the 802.15.4 RF physical layer:

- Maximum power: 8.61mW (9.35 dBm) Equivalent Isotropically Radiated Power (EIRP).
- Frequencies: 5 MHz channel spacing, beginning at 2405 MHz and ending at 2480 MHz.

When using the Bluetooth low energy technology RF physical layer:

- Maximum power: 9.02mW (9.55 dBm) Equivalent Isotropically Radiated Power (EIRP).
- Frequencies: 2 MHz channel spacing, beginning at 2402 MHz and ending at 2480 MHz.

OEM labeling requirements

The "CE" marking must be affixed to a visible location on the OEM product. The following figure shows CE labeling requirements.

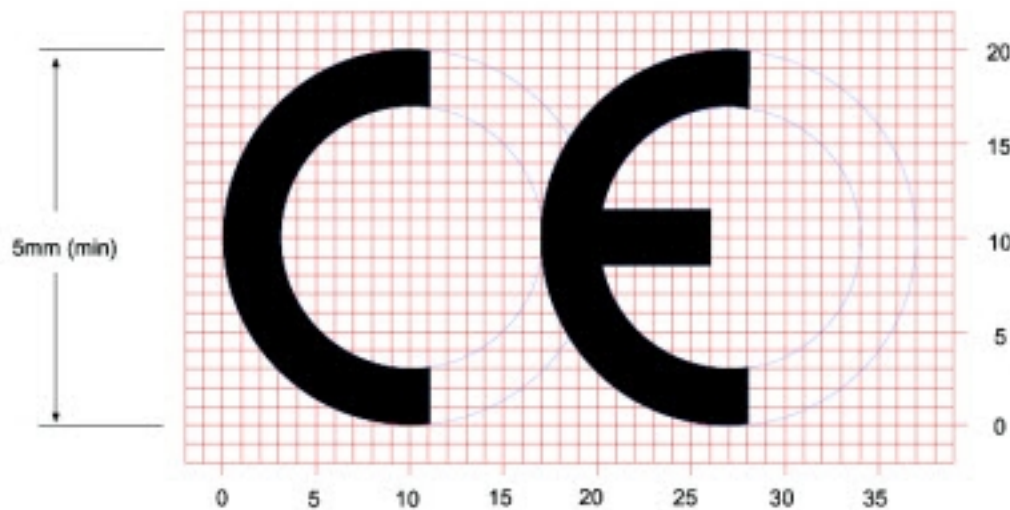

The CE mark shall consist of the initials “CE” taking the following form:

- If the CE marking is reduced or enlarged, the proportions given in the above graduated drawing must be respected.
- The CE marking must have a height of at least 5 mm except where this is not possible on account of the nature of the apparatus.
- The CE marking must be affixed visibly, legibly, and indelibly.

Important note

Digi customers assume full responsibility for learning and meeting the required guidelines for each country in their distribution market. Refer to the radio regulatory agency in the desired countries of operation for more information.

Declarations of conformity

Digi has issued Declarations of Conformity for the XBee3 RF Modules concerning emissions, EMC, and safety. For more information, see www.digi.com/resources/certifications.

Antennas

The following antennas have been tested and approved for use with the XBee3 RF Module:

All antenna part numbers followed by an asterisk (*) are not available from Digi. Consult with an antenna manufacturer for an equivalent option.

- Dipole (2.1 dBi, Omni-directional, Articulated RPSMA, Digi part number A24-HABSM)
- PCB antenna (surface mount boards only) (0.0 dBi)
- Chip antenna (micro form factor only) (0.0 dBi)
- PCB antenna (through-hole boards only) (-0.5 dBi)
- Integral Dipole (USB Adapter only) (0.87 dBi)

ISED (Innovation, Science and Economic Development Canada)

Labeling requirements

Labeling requirements for Industry Canada are similar to those of the FCC. A clearly visible label on the outside of the final product enclosure must display the following text.

For XBee3

Contains Model XBEE3, IC: 1846A-XBEE3

The integrator is responsible for its product to comply with IC ICES-003 & FCC Part 15, Sub. B - Unintentional Radiators. ICES-003 is the same as FCC Part 15 Sub. B and Industry Canada accepts FCC test report or CISPR 22 test report for compliance with ICES-003.

This device complies with Industry Canada licence-exempt RSS standard(s). Operation is subject to the following two conditions: (1) this device may not cause interference, and (2) this device must accept any interference, including interference that may cause undesired operation of the device.

Le présent appareil est conforme aux CNR d'Industrie Canada applicables aux appareils radio exempts de licence. L'exploitation est autorisée aux deux conditions suivantes: (1) l'appareil ne doit pas produire de brouillage, et (2) l'utilisateur de l'appareil doit accepter tout brouillage radioélectrique subi, même si le brouillage est susceptible d'en compromettre le fonctionnement.

RF Exposure



CAUTION! This equipment is approved for mobile and base station transmitting devices only. Antenna(s) used for this transmitter must be installed to provide a separation distance of at least 20 cm from all persons and must not be co-located or operating in conjunction with any other antenna or transmitter.



ATTENTION! Cet équipement est approuvé pour la mobile et la station base dispositifs d'émission seulement. Antenne(s) utilisé pour cet émetteur doit être installé pour fournir une distance de séparation d'au moins 20 cm à partir de toutes les personnes et ne doit pas être situé ou fonctionner en conjonction avec tout autre antenne ou émetteur.

XBee3 USB Adapter

The XBee3 USB Adapter integrates an XBee3 RF Module into its hardware. Special SAR testing was undertaken for the XBee3 USB Adapter product to ensure it met IC standards. It is approved as a portable application.

Transmitters with Detachable Antennas

This radio transmitter (IC: 1846A-XBEE3) has been approved by Industry Canada to operate with the antenna types listed in [FCC-approved antennas \(2.4 GHz\)](#) with the maximum permissible gain and required antenna impedance for each antenna type indicated. Antenna types not included in this list, having a gain greater than the maximum gain indicated for that type, are strictly prohibited for use with this device.

Le présent émetteur radio (IC: 1846A-XBEE3) a été approuvé par Industrie Canada pour fonctionner avec les types d'antenne énumérés ci-dessous et ayant un gain admissible maximal et l'impédance

requis pour chaque type d'antenne. Les types d'antenne non inclus dans cette liste, ou dont le gain est supérieur au gain maximal indiqué, sont strictement interdits pour l'exploitation de l'émetteur.

Detachable Antenna

Under Industry Canada regulations, this radio transmitter may operate using only an antenna of a type and maximum (or lesser) gain approved for the transmitter by Industry Canada. To reduce potential radio interference to other users, the antenna type and its gain should be so chosen that the equivalent isotropically radiated power (EIRP) is not more than that necessary for successful communication.

Conformément à la réglementation d'Industrie Canada, le présent émetteur radio peut fonctionner avec une antenne d'un type et d'un gain maximal (ou inférieur) approuvé pour l'émetteur par Industrie Canada. Dans le but de réduire les risques de brouillage radioélectrique à l'intention des autres utilisateurs, il faut choisir le type d'antenne et son gain de sorte que la puissance isotrope rayonnée équivalente (p.i.r.e.) ne dépasse pas l'intensité nécessaire à l'établissement d'une communication satisfaisante.

Australia (RCM)/New Zealand

XBee3 and XBee3-PRO modules comply with requirements to be used in end products in Australia and New Zealand. All products with EMC and radio communications must have registered RCM and R-NZ marks. Registration to use the compliance mark will only be accepted from Australia or New Zealand manufacturers or importers, or their agents.

In order to have an RCM or R-NZ mark on an end product, a company must comply with a or b below.

- a. have a company presence in Australia or New Zealand.
- b. have a company/distributor/agent in Australia or New Zealand that will sponsor the importing of the end product.

Contact Digi for questions related to locating a contact in Australia and New Zealand.

Japan (TELEC)

The XBee3 (not XBee3-PRO) complies with Japan MIC Article 2 Paragraph 1, Item 19.

The customer product is subject to testing for conformity to the same Japanese standard.

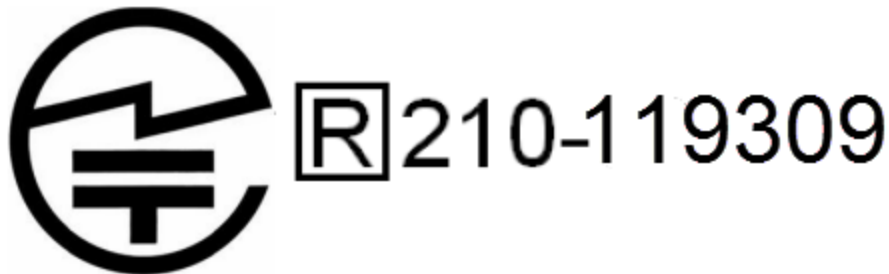

Brazil ANATEL

The XBee3 ZigBee, DigiMesh and 802.15.4 radio modules comply with the requirements of ANATEL to be used in Brazil. The customer's product is subject to testing for conformity to the same Brazilian standards.

Modelo: XBee3

Atendimento à Regulamentação Anatel

Este equipamento não tem direito à proteção contra interferência prejudicial e não pode causar interferência em sistemas devidamente autorizados.

Este produto está homologado pela ANATEL, de acordo com os procedimentos regulamentados pela Resolução 242/2000, e atende aos requisitos técnicos aplicados.

Para maiores informações, consulte o site da ANATEL www.anatel.gov.br.



06329-18-01209

South Korea

The XBee3 (not XBee3-PRO) complies with South Korea's Korea Communications Commission (KCC) Clause 2, Article 58-2 of Radio Waves Act.

The customer's product is subject to testing for conformity to the same South Korea standards.



XBIB-C development boards

This section describes the XBIB-C development boards and how to interact with them.

XBIB-C Micro Mount reference	57
XBIB-C SMT reference	59
XBIB-CU TH reference	61
XBIB-C-GPS reference	63
Interface with the XBIB-C-GPS module	65

XBIB-C Micro Mount reference

This picture shows the XBee-C Micro Mount development board and the table that follows explains the callouts in the picture.

Note This board is sold separately.

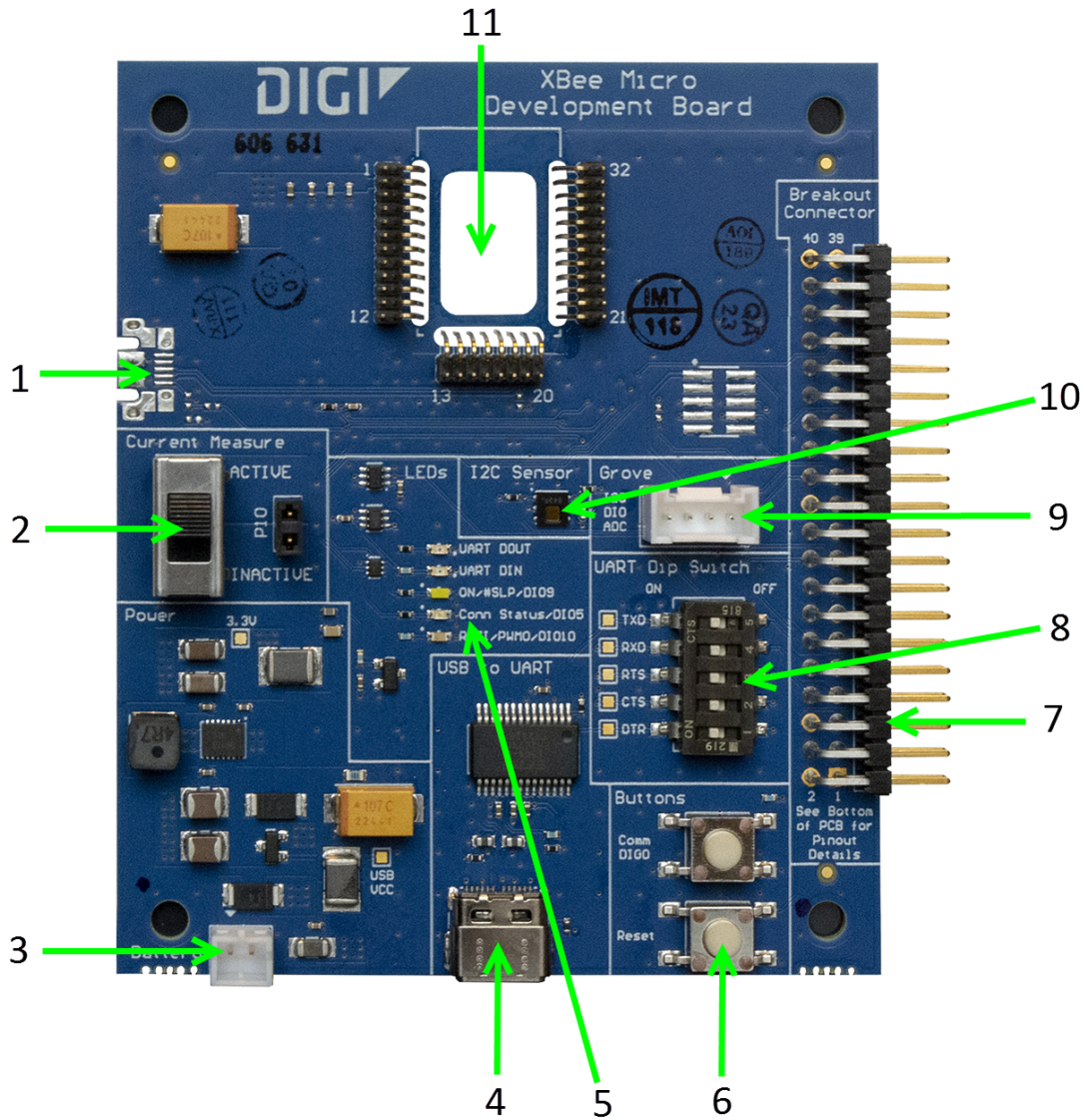

Number	Item	Description
1	Secondary USB (USB MICRO B)	Secondary USB Connector for possible future use. Not used.
2	Current Measure	Large switch controls whether current measure mode is active or inactive. When inactive, current can freely flow to the VCC pin of the XBee. When active, the VCC pin of the XBee is disconnected from the 3.3 V line on the development board. This allows current measurement to be conducted by attaching a current meter across the jumper P10.
3	Battery Connector	If desired, you can attach a battery to provide power to the development board. The voltage can range from 2 V to 5 V. The positive terminal is on the left.
4	USB-C Connector	Connects to your computer. This is connected to a USB to UART conversion chip that has the five UART lines passed to the XBee device. The UART Dip Switch can be used to disconnect these UART lines from the XBee.
5	LED indicator	Red: UART DOUT (modem sending serial/UART data to host) Green: UART DIN (modem receiving serial/UART data from host) White: ON/SLP/DIO9 Blue: Connection Status/DIO5 Yellow: RSSI/PWM0/DIO10
6	User Buttons	Comm DIO0 Button connects the Commissioning/DIO0 pin on the XBee Connector through to a 10 Ω resistor to GND when pressed. RESET Button Connects to the RESET pin on the XBee Connector to GND when pressed.
7	Breakout Connector	This 40-pin connector can be used to connect to various XBee pins as shown on the silkscreen on the bottom of the board.
8	UART Dip Switch	This dip switch allows the user to disconnect any of the primary UART lines on the XBee from the USB to UART conversion chip. This allows for testing on the primary UART lines without the USB to UART conversion chip interfering. Push Dip switches to the right to disconnect the USB to UART conversion chip from the XBee.
9	Grove Connector	This connector can be used to attach I2C enabled devices to the development board. Note that I2C needs to be available on the XBee in the board to use this functionality. Pin 1: I2C_CLK/XBee DIO1 Pin2: I2C_SDA/XBee DIO11 Pin3: VCC Pin4: GND
10	Temp/Humidity Sensor	This as a Texas Instruments HDC1080 temperature and humidity sensor. This part is accessible through I2C. Be sure that the XBee that is inserted into the development board has I2C if access to this sensor is desired.
11	XBee Socket	This is the socket for the XBee (Micro form factor).

XBIB-C SMT reference

This picture shows the XBee-C SMT development board and the table that follows explains the callouts in the picture.

Note This board is sold separately.

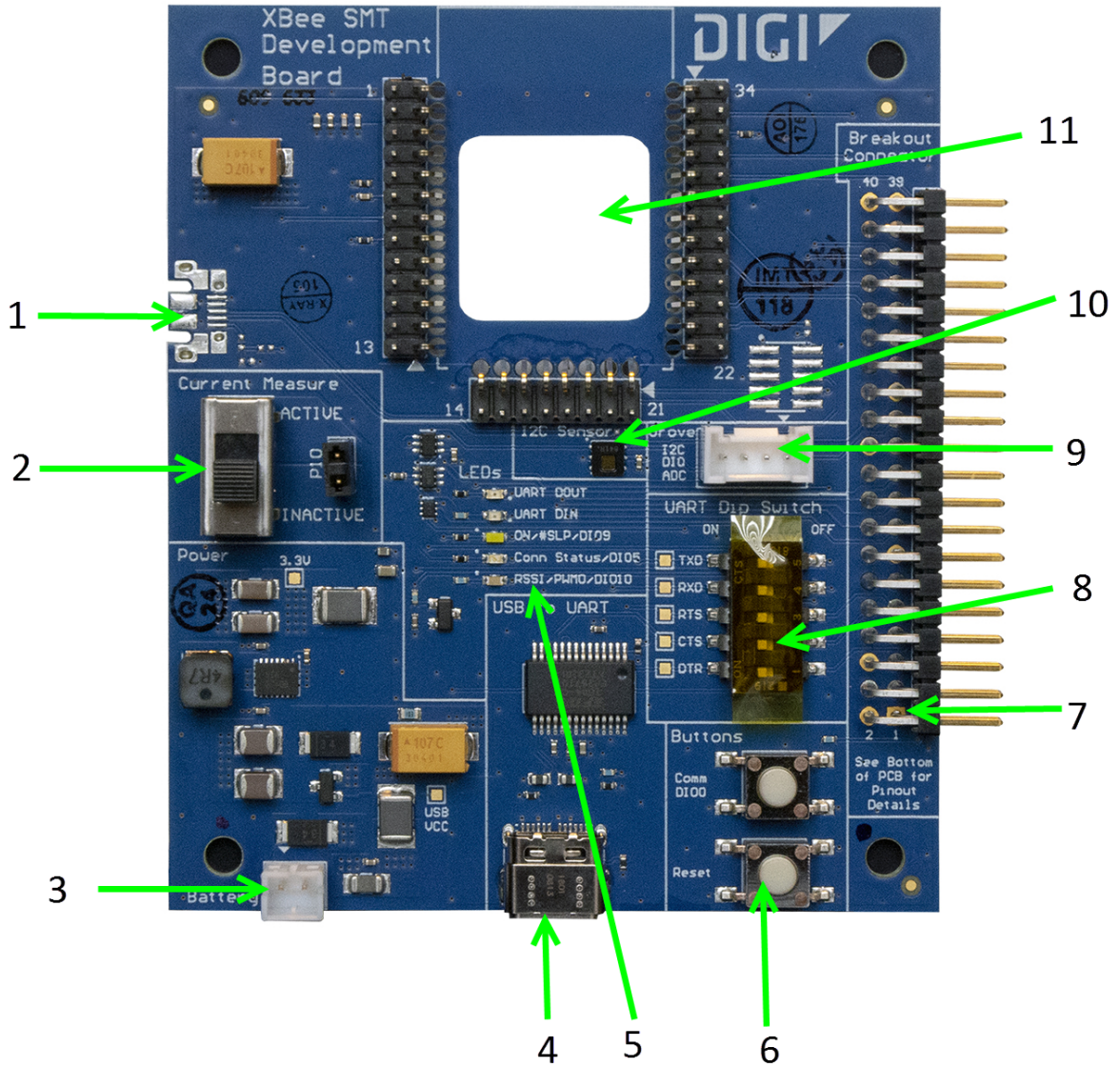



Number	Item	Description
1	Secondary USB (USB MICRO B)	Secondary USB Connector for possible future use. Not used.
2	Current Measure	Large switch controls whether current measure mode is active or inactive. When inactive, current can freely flow to the VCC pin of the XBee. When active, the VCC pin of the XBee is disconnected from the 3.3 V line on the dev board. This allows current measurement to be conducted by attaching a current meter across the jumper P10.
3	Battery Connector	If desired, you can attach a battery to provide power to the development board. The voltage can range from 2 V to 5 V. The positive terminal is on the left.
4	USB-C Connector	Connects to your computer. This is connected to a USB to UART conversion chip that has the five UART lines passed to the XBee. The UART Dip Switch can be used to disconnect these UART lines from the XBee.
5	LED indicator	Red: UART DOUT (modem sending serial/UART data to host) Green: UART DIN (modem receiving serial/UART data from host) White: ON/SLP/DIO9 Blue: Connection Status/DIO5 Yellow: RSSI/PWM0/DIO10
6	User Buttons	Comm DIO0 Button connects the Commissioning/DIO0 pin on the XBee Connector through to a 10 Ω resistor to GND when pressed. RESET Button Connects to the RESET pin on the XBee Connector to GND when pressed.
7	Breakout Connector	This 40-pin connector can be used to connect to various XBee pins as shown on the silkscreen on the bottom of the board.
8	UART Dip Switch	This dip switch allows the user to disconnect any of the primary UART lines on the XBee from the USB to UART conversion chip. This allows for testing on the primary UART lines without the USB to UART conversion chip interfering. Push Dip switches to the right to disconnect the USB to UART conversion chip from the XBee.
9	Grove Connector	This connector can be used to attach I2C enabled devices to the development board. Note that I2C needs to be available on the XBee in the board to use this functionality. Pin 1: I2C_CLK/XBee DIO1 Pin2: I2C_SDA/XBee DIO11 Pin3: VCC Pin4: GND
10	Temp/Humidity Sensor	This as a Texas Instruments HDC1080 temperature and humidity sensor. This part is accessible through I2C. Be sure that the XBee that is inserted into the Dev Board has I2C if access to this sensor is desired.
11	XBee Socket	This is the socket for the XBee (SMT form factor)

XBIB-CU TH reference

This picture shows the XBee-CU TH development board and the table that follows explains the callouts in the picture.

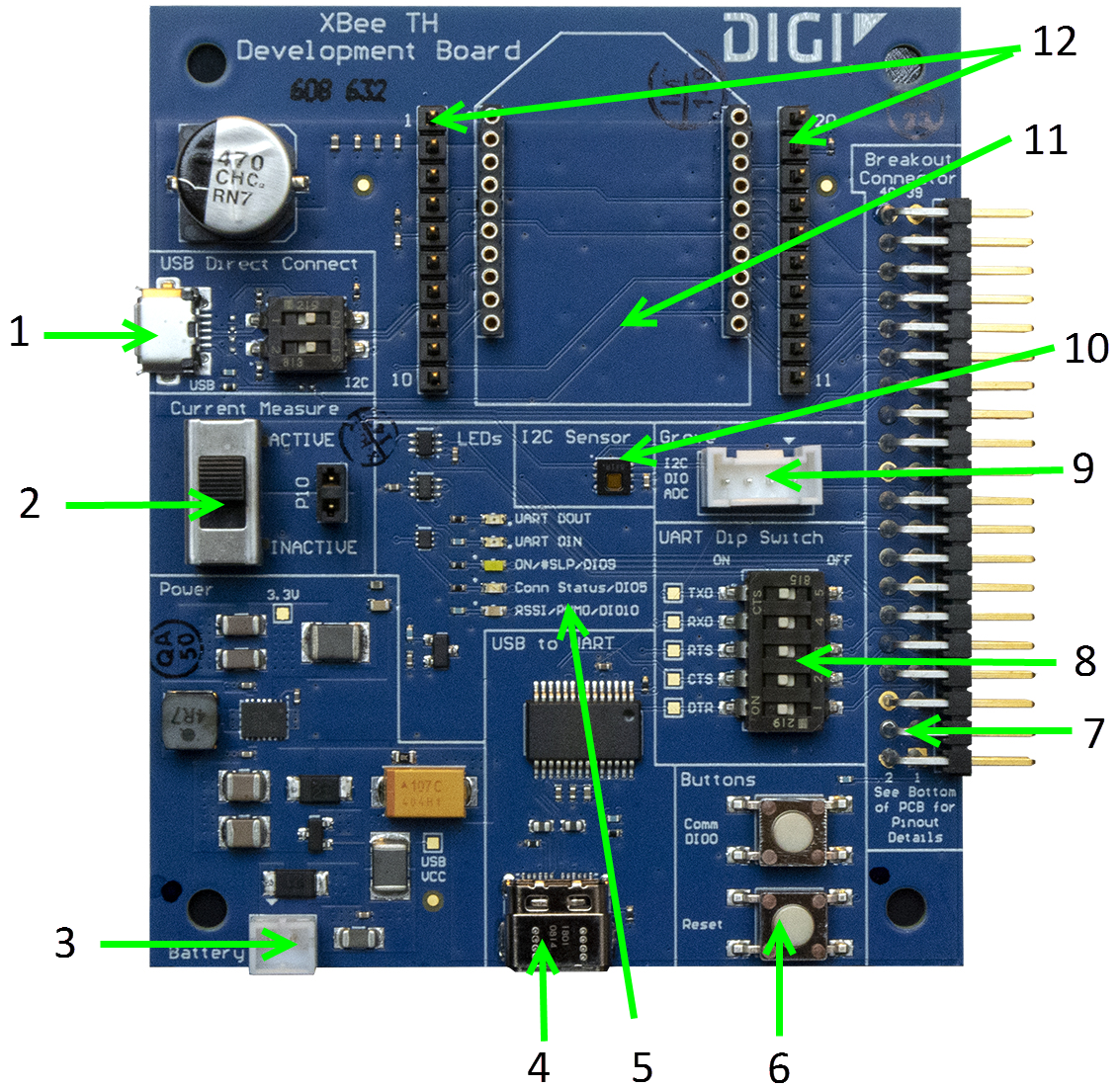
Note This board is sold separately.



Number	Item	Description
1	Secondary USB (USB MICRO B) and DIP Switch	<p>Secondary USB Connector for direct programming of modules on some XBee units. Flip the Dip switches to the right for I2C access to the board; flip Dip switches to the left to disable I2C access to the board. The USB_P and USB_N lines are always connected to the XBee, regardless of Dip switch setting. This USB port is not designed to power the module or the board. Do not plug in a USB cable here unless the board is already being powered through the main USB-C connector. Do not attach a USB cable here if the Dip switches are pushed to the right.</p> <hr/> <div style="display: flex; align-items: center;">  <p>WARNING! Direct input of USB lines into XBee units or I2C lines not designed to handle 5V can result in the destruction of the XBee or I2C components. Could cause fire or serious injury. Do not plug in a USB cable here if the XBee device is not designed for it and do not plug in a USB cable here if the Dip switches are pushed to the right.</p> </div> <hr/>
2	Current Measure	Large switch controls whether current measure mode is active or inactive. When inactive, current can freely flow to the VCC pin of the XBee. When active, the VCC pin of the XBee is disconnected from the 3.3 V line on the development board. This allows current measurement to be conducted by attaching a current meter across the jumper P10.
3	Battery Connector	If desired, a battery can be attached to provide power to the development board. The voltage can range from 2 V to 5 V. The positive terminal is on the left. If the USB-C connector is connected to a computer, the power will be provided through the USB-C connector and not the battery connector.
4	USB-C Connector	Connects to your computer and provides the power for the development board. This is connected to a USB to UART conversion chip that has the five UART lines passed to the XBee. The UART Dip Switch can be used to disconnect these UART lines from the XBee.
5	LED indicator	<p>Red: UART DOUT (modem sending serial/UART data to host) Green: UART DIN (modem receiving serial/UART data from host) White: ON/SLP/DIO9 Blue: Connection Status/DIO5 Yellow: RSSI/PWM0/DIO10</p>
6	User Buttons	<p>Comm DIO0 Button connects the Commissioning/DIO0 pin on the XBee Connector through to a 10 Ω resistor to GND when pressed.</p> <p>RESET Button Connects to the RESET pin on the XBee Connector to GND when pressed.</p>
7	Breakout Connector	This 40 pin connector can be used to connect to various XBee pins as shown on the silkscreen on the bottom of the board.

Number	Item	Description
8	UART Dip Switch	This dip switch allows the user to disconnect any of the primary UART lines on the XBee from the USB to UART conversion chip. This allows for testing on the primary UART lines without the USB to UART conversion chip interfering. Push Dip switches to the right to disconnect the USB to UART conversion chip from the XBee.
9	Grove Connector	This connector can be used to attach I2C enabled devices to the development board. Note that I2C needs to be available on the XBee in the board for this functionality to be used. Pin 1: I2C_CLK/XBee DIO1 Pin2: I2C_SDA/XBee DIO11 Pin3: VCC Pin4: GND
10	Temp/Humidity Sensor	This as a Texas Instruments HDC1080 temperature and humidity sensor. This part is accessible through I2C. Be sure that the XBee that is inserted into the development board has I2C if access to this sensor is desired.
11	XBee Socket	This is the socket for the XBee (TH form factor).
12	XBee Test Point Pins	Allows easy access for probes for all 20 XBee TH pins. Pin 1 is shorted to Pin 1 on the XBee and so on.

XBIB-C-GPS reference

This picture shows the XBIB-C-GPS module and the table that follows explains the callouts in the picture.

Note This board is sold separately. You must also have purchased an XBIB-C through-hole, surface-mount, or micro-mount development board.

Note For a demonstration of how to use MicroPython to parse some of the GPS NMEA sentences from the UART, print them and report them to Digi Remote Manager, see [Run the MicroPython GPS demo](#).

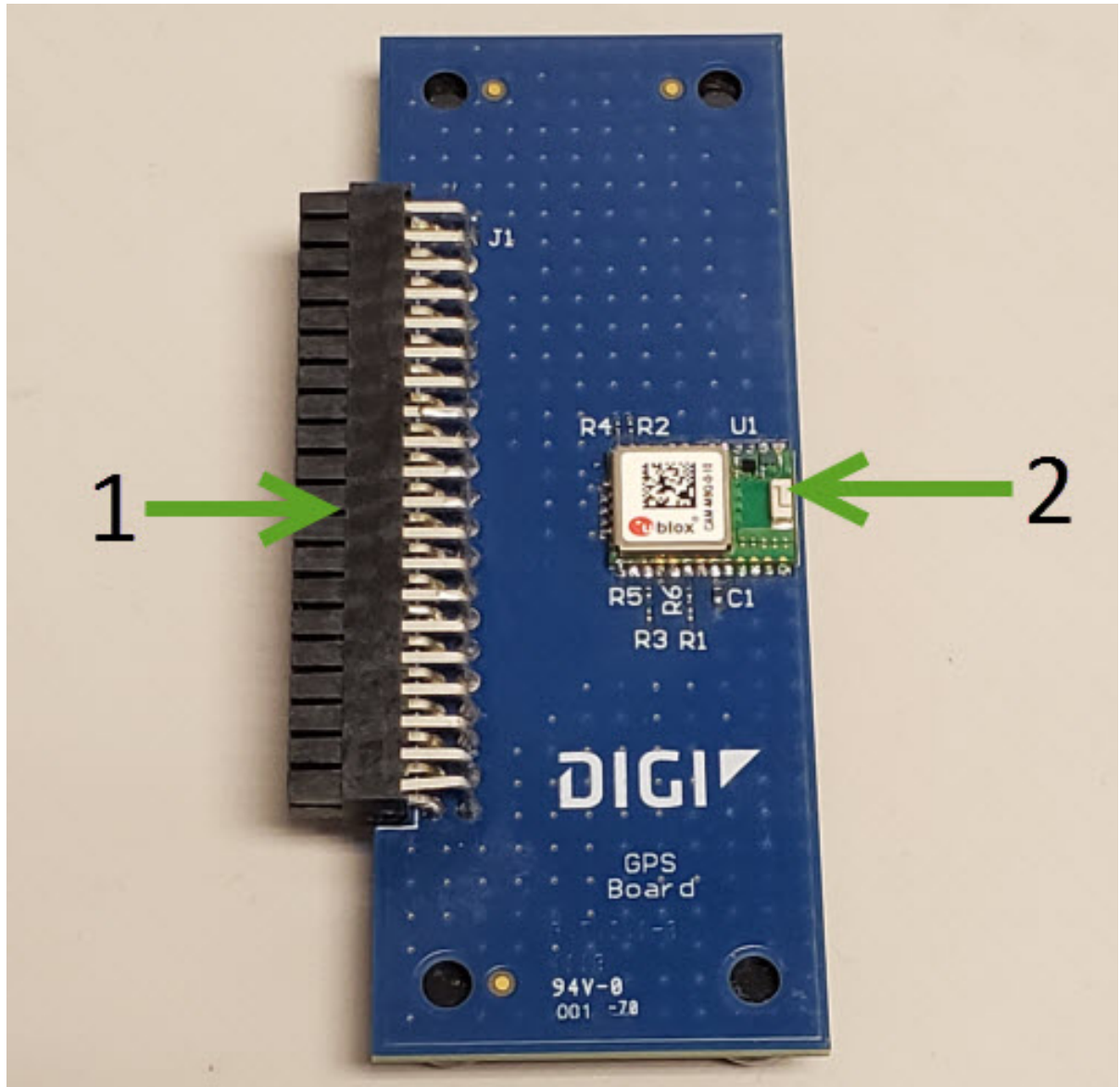

Number	Item	Description
1	40-pin header	This header is used to connect the XBIB-C-GPS board to a compatible XBIB development board. Insert the XBIB-C-GPS module slowly with alternating pressure on the upper and lower parts of the connector. If added or removed improperly, the pins on the attached board could bend out of shape.
2	GPS unit	This is the CAM-M8Q-0-10 module made by u-blox. This is what makes the GPS measurements. Proper orientation is with the board laying completely flat, with the module facing towards the sky.

Interface with the XBIB-C-GPS module

The XBee3 RF Module can interface with the XBIB-C-GPS board through the large 40-pin header. This header is designed to fit into XBIB-C development board. This allows the XBee3 RF Module in the XBIB-C board to communicate with the XBIB-C-GPS board—provided the XBee device used has MicroPython capabilities (see [this link](#) to determine which devices have MicroPython capabilities). There are two ways to interface with the XBIB-C-GPS board: through the host board’s Secondary UART or through the I2C compliant lines.

The following picture shows a typical setup:



I²C communication

There are two I2C lines connected to the host board through the 40-pin header, SCL and SDA. I2C communication is performed over an I2C-compliant Display Data Channel. The XBIB-C-GPS module operates in slave mode. The maximum frequency of the SCL line is 400 kHz. To access data through the I2C lines, the data must be queried by the connected XBee3 RF Module.

For more information about I2C Operation see the **I2C** section of the [Digi Micro Python Programming Guide](#).

For more information on the operation of the XBIB-C-GPS board see the [CAM-M8 datasheet](#). Other CAM-M8 documentation is located [here](#).

UART communication

There are two UART pins connected from the XBIB-C-GPS to the host board by the 40-pin header: RX and TX. By default, the UART on the XBIB-C-GPS board is active and sends GPS readings to the connected device's secondary UART pins. Readings are transmitted once every second. The baud rate of the UART is 9600 baud.

For more information about using Micro Python to communicate to the XBIB-C-GPS module, see [Class UART](#).

Manufacturing information

The surface-mount and micro XBee3 RF Module are designed for surface-mounting on the OEM PCB. It has castellated pads to allow for easy solder attaching and inspection. The pads are all located on the edge of the device so there are no hidden solder joints on these devices.

Recommended solder reflow cycle	68
Handling and storage	68
Recommended footprint	68
Flux and cleaning	70
Reworking	71

Recommended solder reflow cycle

The following diagram shows the recommended solder reflow cycle.

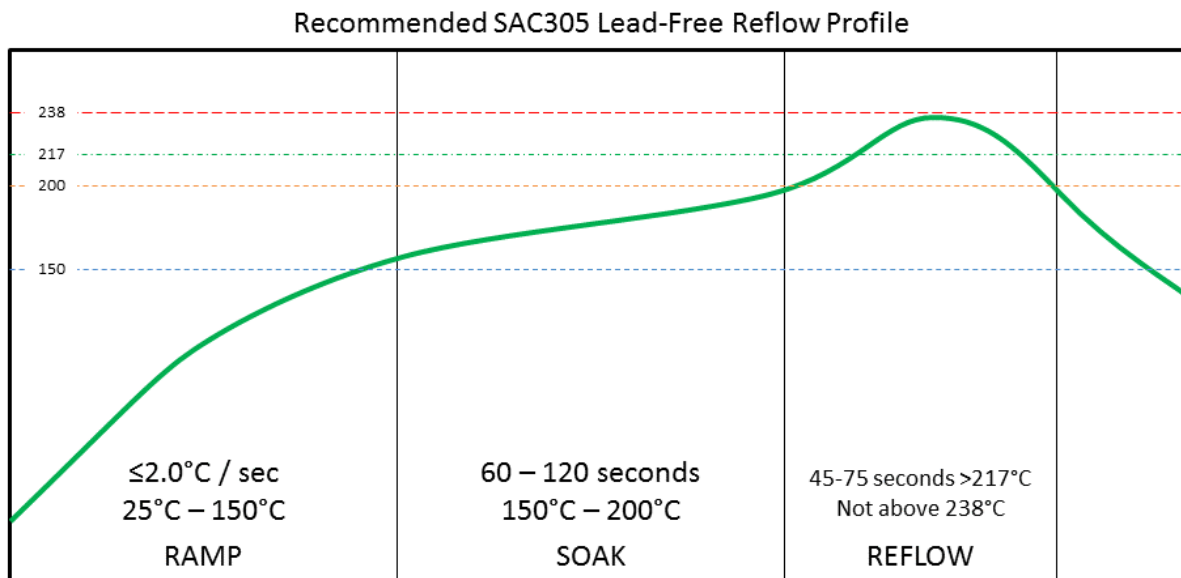

Recommended reflow profile only
Modifications to profile may be required to fit specific application, process or design

The device reflows during this cycle, and must not be reflowed upside down. Be careful not to jar the device while the solder is molten, as parts inside the device can be removed from their required locations.

Hand soldering is possible and should be done in accordance with approved standards.

Handling and storage

The XBee3 RF Modules are level 3 Moisture Sensitive Devices. When using this kind of device, consider the relative requirements in accordance with standard IPC/JEDEC J-STD-020.

In addition, note the following conditions:

- a. Calculated shelf life in sealed bag: 12 months at <40 °C and <90% relative humidity (RH).
- b. Environmental condition during the production: 30 °C /60% RH according to IPC/JEDEC J-STD-033C, paragraphs 5 through 7.
- c. The time between the opening of the sealed bag and the start of the reflow process cannot exceed 168 hours if condition b) is met.
- d. Baking is required if conditions b) or c) are not met.
- e. Baking is required if the humidity indicator inside the bag indicates a RH of 10% more.
- f. If baking is required, bake modules in trays stacked no more than 10 high for 4-6 hours at 125 °C.

Recommended footprint

We recommend that you use the following PCB footprints for surface-mounting. The dimensions without brackets are in inches, and those in brackets are in millimeters.

XBee3 surface-mount recommended footprint

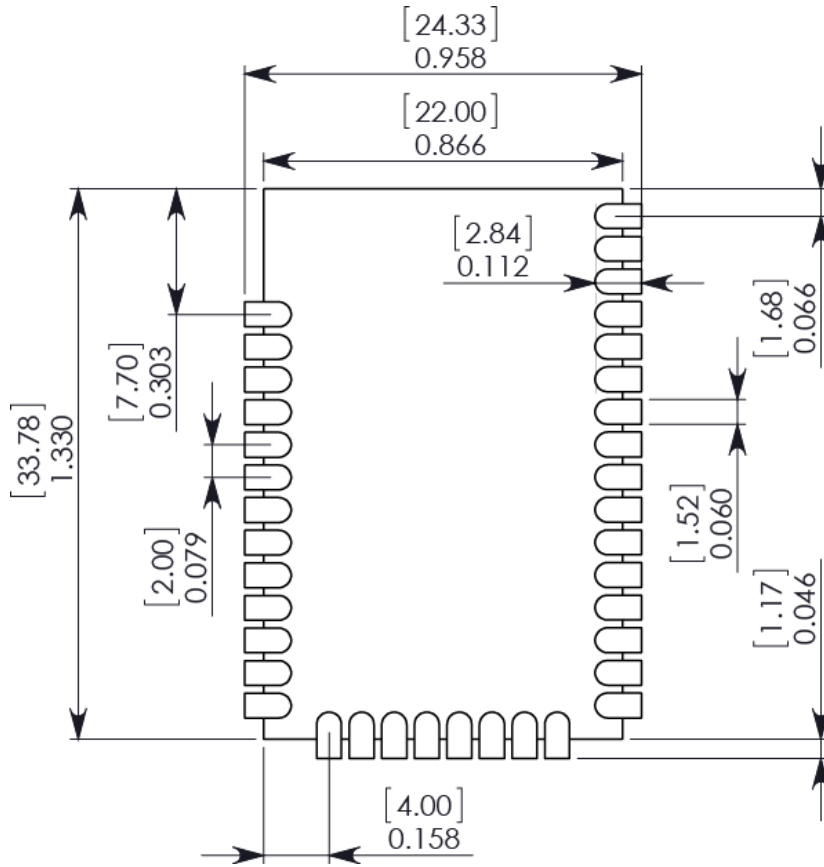

XBee3 Micro recommended footprint

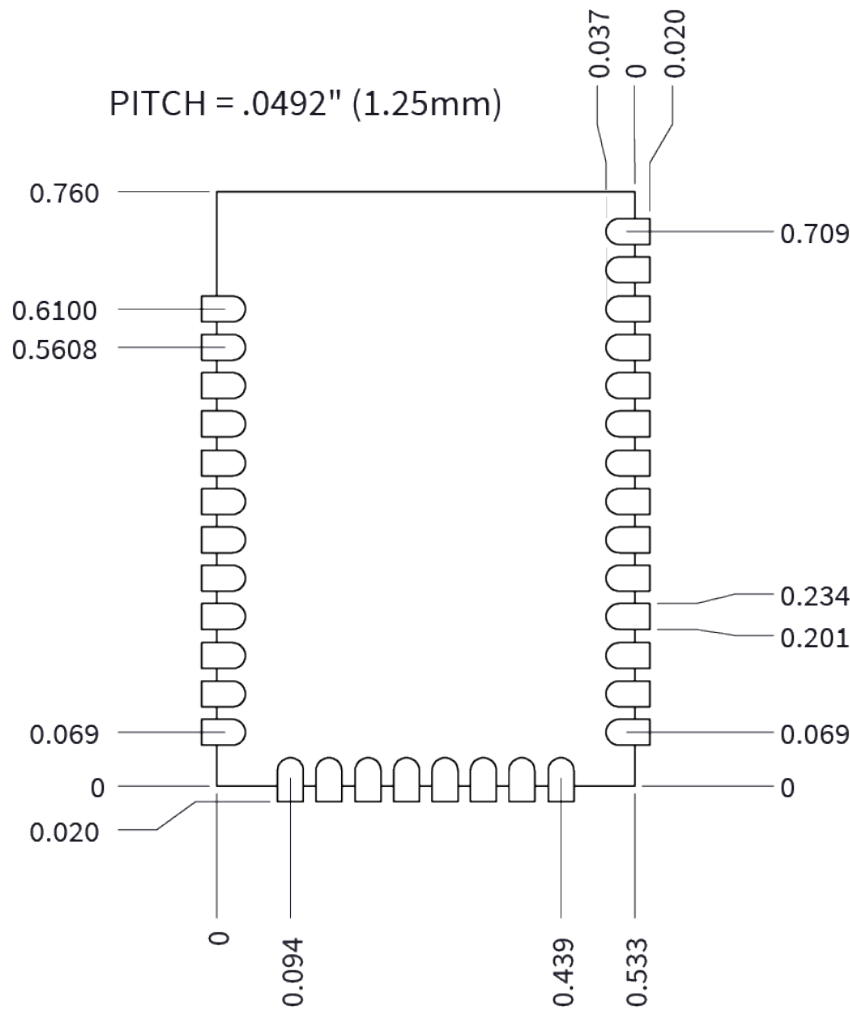

Match the solder footprint to the copper pads, but it may need to be adjusted depending on the specific needs of assembly and product standards. Recommended stencil thickness is 0.15 mm/0.005". Place the component last and set the placement speed to the slowest setting.

Flux and cleaning

Digi recommends that a "no clean" solder paste be used in assembling these devices. This eliminates the clean step and ensures unwanted residual flux is not left under the device where it is difficult to remove.

In addition the following issues can occur:

- Cleaning with liquids can result in liquid remaining under the shield or in the gap between the device and the OEM PCB. This can lead to unintended connections between pads on the device.
- The residual moisture and flux residue under the device are not easily seen during an inspection process.

Factory recommended best practice is to use a "no clean" solder paste to avoid these issues and ensure proper device operation.

Reworking

Never perform rework on the device itself. The device has been optimized to give the best possible performance, and reworking the device itself will void warranty coverage and certifications. We recognize that some customers choose to rework and void the warranty. The following information serves as a guideline in such cases to increase the chances of success during rework, though the warranty is still voided.

The device may be removed from the OEM PCB by the use of a hot air rework station, or hot plate. Be careful not to overheat the device. During rework, the device temperature may rise above its internal solder melting point and care should be taken not to dislodge internal components from their intended positions.

Troubleshooting

This section contains troubleshooting steps for the XBee3 RF Module.

Brownout issue	73
----------------------	----

Brownout issue

The XBee3 RF Module uses a Silicon Labs EFR32MG System on Chip (SoC). Silicon Labs has announced an intermittent restarting issue with EFR32MG revision B SoCs which can be caused by voltage brownout or supply dips during power-on. The information below is provided to help you avoid this issue.

Voltage brownout

This issue may occur if the VCC pin momentarily dips past the specified lower bound of the voltage range (2.1 V) into the range of 1.8 V to approximately 1.2 V. When the supply returns to normal levels the SoC may not restart properly and enter an unresponsive state. You must fully power cycle the XBee3 to recover from this state. The failure rate tends to increase with slower ramp down rates of the power supply; for more details see [RMU_E203 — AVDD Ramp Issue](#). If the part is kept within the operational voltage range specified in [Power requirements](#), the conditions to cause this failure are never met.

Voltage ramp up discontinuities

This issue is similar to the voltage brownout issue. The SoC may fail to start if, during power on, the supply powering the VCC pin experiences discontinuities in the voltage rise (in other words, dips) while the voltage is in the range of approximately 1.2 to 1.8 V. You must fully power cycle the XBee3 to recover from this state. The failure rate tends to increase with slower ramp up rates of the power supply; for more details see [RMU_E203 — AVDD Ramp Issue](#). The issue can be avoided by ramping your power supply steadily to the normal operating range.

How to distinguish revision B parts

Silicon Labs has corrected these issues in revision C of their SoC. We are printing the SoC revision on the XBee3 label to make it easy to distinguish. The letter is located on the right edge of the sticker and rotated 90 degrees. There were some parts made before this issue was identified that do not have the revision letter printed on the sticker. All of those parts are revision B parts.