



SMB/SMB-LOCK/SMC

R114/R117/R112

Contents**SMB**

Introduction	6-4 to 6-5
Interface	6-6
Characteristics	6-7 to 6-8
Plugs	6-8 to 6-11
Jacks	6-10 to 6-12
Bulkhead jacks	6-12 to 6-14
Receptacles	6-14 to 6-15
PCB receptacles	6-15 to 6-16
Adapters	6-17
Panel drilling	6-22
Assembly instructions	6-22

SMB-LOCK

Introduction	6-18
Interface	6-18
Characteristics	6-19
Plugs	6-20

SMB LIMITED DETENT (SMB-A)

Receptacles	6-21
-------------------	------

SMB SLIDE-ON (SUBGLIS)

Plugs and receptacles	6-21
-----------------------------	------

SMC

Introduction	6-23
Interface	6-23
Characteristics	6-24
Plugs	6-25
Jacks	6-25 to 6-27
Receptacles	6-27 to 6-28
Adapters	6-28
Panel drilling	6-28

Introduction

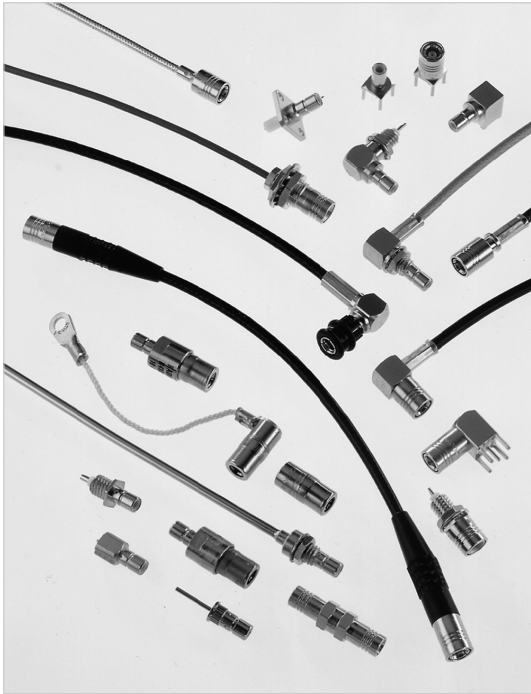

50Ω	DC - 4 GHz
-----	------------

GENERAL

- Subminiature coaxial connectors
- Snap-on coupling
- Plugs have female contacts
- Jacks have male contacts
- Low weight and reduced outline dimensions
- Captive contact (except contrary specification)

APPLICABLE STANDARDS

- SMB series MIL-C-39012
MIL-C-39012/67-72
- IEC 169-10
- CECC 22130
- BS 9210 N0007

APPLICATIONS

- Mobile communication systems
- Civil and military telecommunications
- Aeronautics
- Automotive

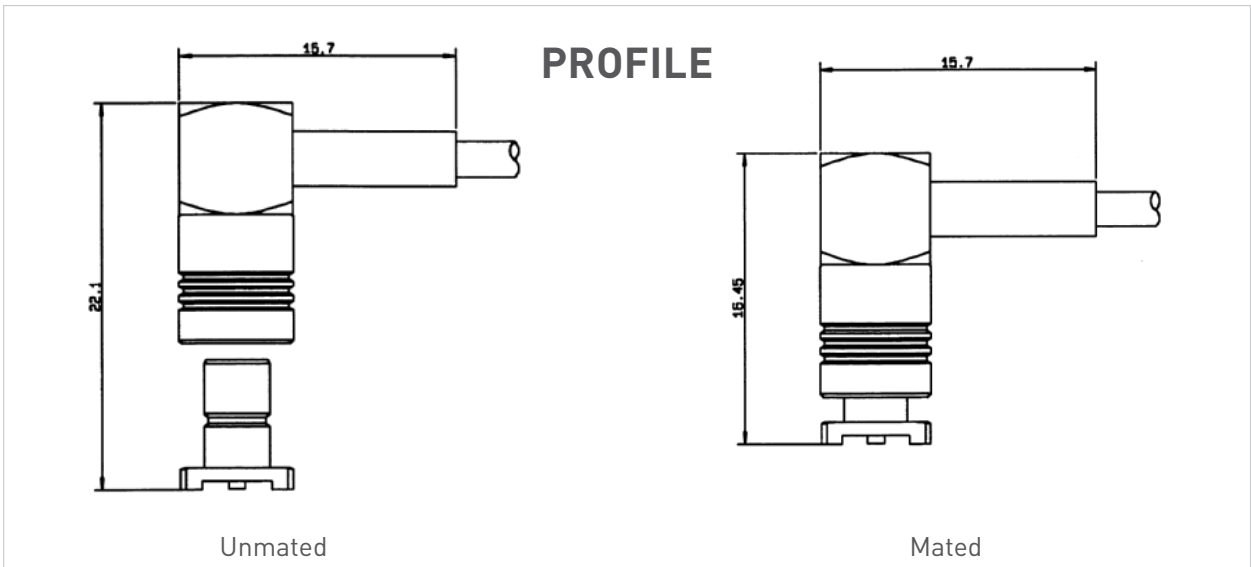

Introduction

SMB snap-on subminiature coaxial connectors provide a fast and reliable connection for high density packaging for applications up to 4 GHz.

Radiall offers a very large range of SMB connectors, including cable plugs and jacks with bulkhead and panel mount configurations, bulkhead and panel mount receptacles; through hole, SMT and edge card receptacles and in-series and between series adapters.

SMB series also features versions with lower mating forces than standard. Four types of interconnection mechanisms are available:

- **SMB: Standard** snap-on connection
The design permits quick engagement and disengagement.
- **SMB limited detent (SMB-A):** Snap-on connection with **low mating force**
The design permits quick engagement and disengagement, and is suitable for printed circuit boards. Radiall offers a range of PCB and bulkhead receptacles with female center contact. The SMB-A receptacles are completely intermateable with standard SMB jacks.
- **SMB slide-on (SUBGLIS):** Slide-on connection
The design is suitable for back plane and blind mate applications. In this case, we recommend the association of a mobile connector (floating jack / receptacle) with a fixed connector (panel plug / jack, receptacle). The SUBGLIS connectors are completely intermateable with standard SMB and SMB-A connectors and for that, they can be used for test applications.
- **SMB Lock:**
Plugs (with female center contact) have a coupling nut allowing a reliable lock-on connection (50 N min). This range allows a visual control of the locking system.

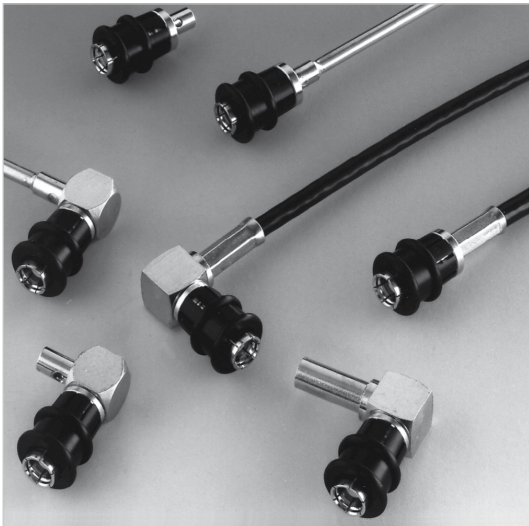

These four types of SMB connectors have the same electrical performance.

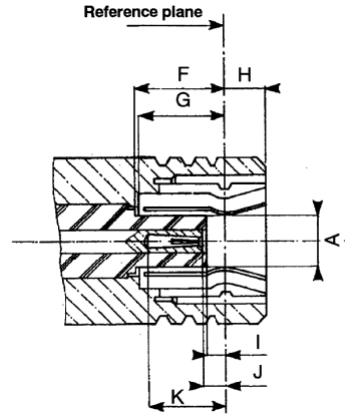
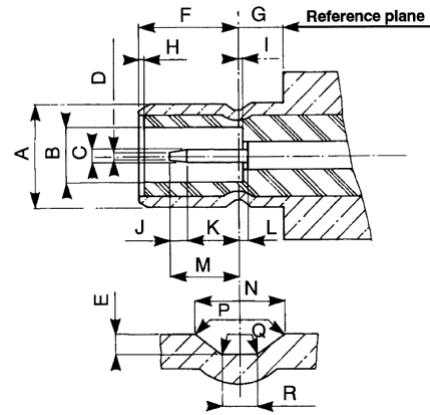
PLUG (with female contact)**JACK** (with male contact)

Letter	mm		inch	
	min.	max.	min.	max.
A DIA	-	2.06	-	.081
F	3.58	-	.141	-
G	3.58	-	.141	-
H	-	1.63	-	.064
I	0.18	-	.007	-
J	0.18	0.94	.007	.037
K	2.97	-	.117	-

Letter	mm		inch	
	min.	max.	min.	max.
A DIA	-	3.71	-	.146
B DIA	2.08	-	.082	-
C DIA	0.48	0.53	.019	.021
D DIA	-	0.25	-	.010
E	0.15	0.25	.006	.010
F	3.33	3.58	.131	.141
G	1.65	-	.065	-
I	-	0.18	-	.007
J	0.25	-	.010	-
K	1.32	-	.052	-
L	-	0.18	-	.007
M	-	2.97	-	.117
N	0.69	0.94	.027	.037
P	0.05	0.15	.002	.006
Q	-	0.13	-	.005
R	0.28	0.38	.011	.015

CLAMP TYPE CONNECTORS: R 114 xxx 000 = braid retention with cylindrical gasket

R 114 xxx 133 = braid retention with V groove gasket

Characteristics

Test / Characteristics	MIL-C-39012 A	Values / Remarks
------------------------	---------------	------------------

ELECTRICAL CHARACTERISTICS

Impedance	-	50Ω			
Frequency range	-	DC - 4 GHz			
V.S.W.R. (typ.)	Frequency	1 GHz	2.5 GHz	4 GHz	
• Straight models	cable group: .085"	-	1.12	1.22	1.33
	2	-	1.10	1.22	1.33
	2.6	-	1.12	1.22	1.35
• Right angle models	.085"	-	1.10	1.18	1.26
	2	-	1.10	1.20	1.25
Insertion loss (typ.) dB	3-27				
• Straight models	cable group: .085"	-	0.05	0.07	0.15
	2	-	0.05	0.10	0.25
	2.6	-	0.05	0.05	0.05
• Right angle models	.085"	-	0.05	0.07	0.12
RF leakage	3-26	-55 dB min from 2 to 3 GHz			
Insulation resistance	3-11	1000 MΩ min			
Contact resistance	3-16	Initial	After test		
• Center contact (mΩ)	-	6	8		
• Outer contact (mΩ)	-	1	1.5		
Working voltage	-	2/50	2.6/50		
• Cable group	-	250 V rms	335 V rms		
• At sea level	-	60 V rms	85 V rms		
• At 70000 ft (21000 m)	-				
Dielectric withstanding voltage	3-17	2/50	2.6/50		
• Cable group	-	750 V rms	1000 V rms		
• At sea level	-	185 V rms	250 V rms		
• At 70000 ft (21000 m)	-				
RF withstanding voltage (5 MHz sine wave)	3-23	2/50	2.6/50		
• Cable group	-	500 V rms	700 V rms		
• At sea level	-				

MECHANICAL CHARACTERISTICS

Durability	3-15	500 matings	
Mating / Unmating	3-5-1	Axial force: 62 N max (14 Lbf)	
Cabling retention force	cable group: • 2/50 • 2.6/50	3-24	58 N (13Lbf) 110 N (25Lbf)
Center contact retention	-	Axial: 10 N (2.25 Lbf)	

ENVIRONMENTAL CHARACTERISTICS

Temperature range	-	-65°C / + 165°C
• Standard models	-	-65°C / +165°C
• Hermetic sealed models	-	-65°C / +105°C
• Models for semi-rigid cables	-	
Combined climate tests		MIL-STD-202, method 102, condition C
Thermal shock	3-20	MIL-STD-202, method 107, condition B
High temperature endurance		MIL-STD-202, method 108
Corrosion (salt spray)	3-13	MIL-STD-202, method 101, condition B, 5%
Vibrations	3-18	MIL-STD-202, method 204, condition B, 15g
Shocks	3-19	MIL-STD-202, method 213, condition B, 75g
Low pressure	3-22	MIL-STD-202, method 105, condition C
Hermetic seal	-	Applied vacuum 10 ⁻⁶ mm of Hg (Torrs) Leakage rate < 10 ⁻⁶ atm/cm ³ /s

MATERIALS AND PLATING

	Material	Plating
Body and center pin contact	Half hard brass as per QQ-B-626	Gold or nickel (Body)
Center socket contact	Beryllium copper as per QQ-C-530	Gold (Center contact)
Ferrules	Brass	-
Insulators	PTFE teflon	-
Gaskets	Silicone elastomer	-

Standard packaging: 100 pieces

All dimensions are given in mm.

Characteristics

POWER RATING

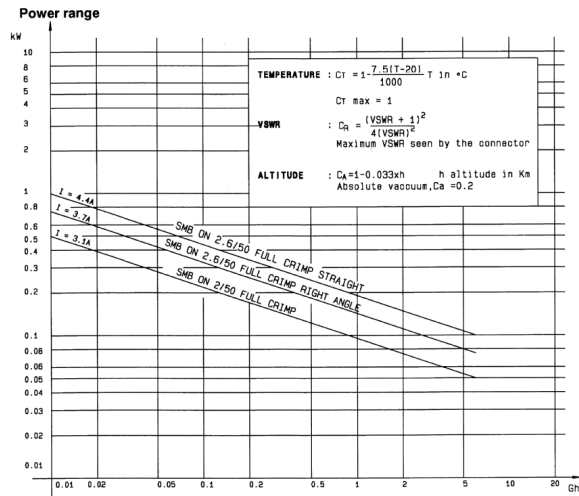

Plugs

STRAIGHT PLUGS CRIMP TYPE FOR FLEXIBLE CABLES

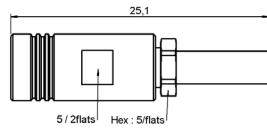

Fig. 1

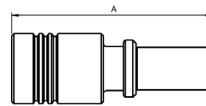

Fig. 2

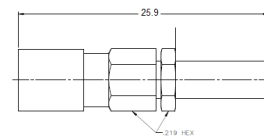

Fig. 3

Cable group	Cable group dia.	Part number	Fig.	Dimensions A (mm)	Captive center contact	Finish	Note	
RG178 / RG196	2/50/S	R114 073 000	1	-	Yes	Gold	-	
RG174 / RG316 / RG179	2.6/50+75/S	R114 075 000		-				
		R114 082 000	19.8	Full crimp				
RD316	2.6/50/D	R114 083 000	2				18.4	
RG178 / RG196	2/50S	2002-1571-002	3	-		Yes	Nickel	-
		2002-7571-002		-				
RD178	2/50D	2002-1571-005		-				
		2002-7571-005		-				
RG174 / RG316	2.6/50S	2002-1571-003		-				
		2002-7571-003		-				
RD316	2.6/50D	2002-1571-019	-					
		2002-7571-019	-	Gold	-			
					Nickel	-		

Plugs and Jacks

STRAIGHT PLUGS CLAMP TYPE FOR FLEXIBLE CABLES

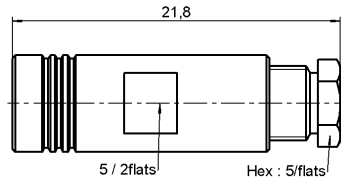

Fig. 1

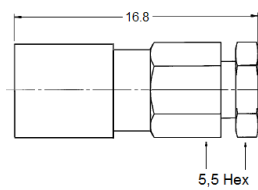

Fig. 2

Cable group	Cable group dia.	Part number (Gold)	Part number (Nickel)	Fig.	Captive center contact
RG178 / RG196	2/50/S	R114 003 000	N/A	1	Yes
RG174 / RG316 / RG179	2.6/50+75/S	R114 005 000			
RG178 / RG196	2/50S	2002-1551-002	2002-7551-002	2	
RD178	2/50D	2002-1551-005			
RG174 / RG316	2.6/50S	2002-7551-003	2002-7551-003		
RD316	2.6/50D	2002-7551-019	2002-7551-019		

STRAIGHT PLUG FOR SEMI RIGID CABLES

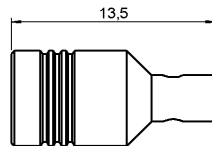

Fig. 1

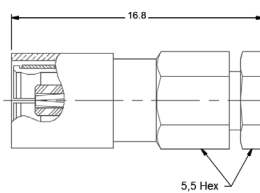

Fig. 2

Cable group	Cable group dia.	Part number (Gold)	Part number (Nickel)	Fig.	Captive center contact	Note
RG405	.085"	R114 053 000	-	1	No	Solder type
		2002-1541-010	2002-7541-010	2	Yes	Solder clamp
RG402	.141"	2002-1541-003	2002-7541-009			

Plugs and Jacks

RIGHT ANGLE PLUGS AND JACKS CRIMP TYPE FOR FLEXIBLE CABLES

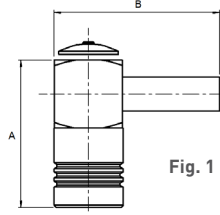

Fig. 1

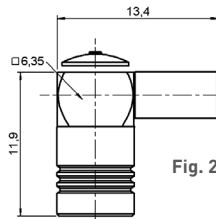

Fig. 2

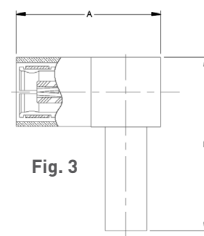

Fig. 3

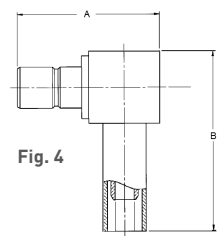
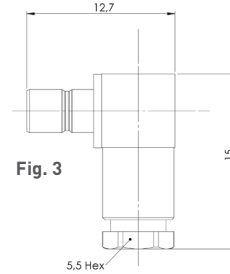
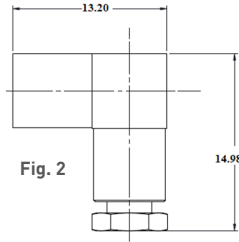
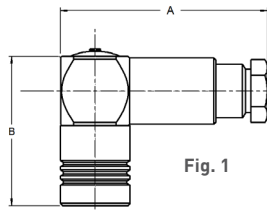

Fig. 4

Cable group	Cable group dia.	Part number (Gold)	Part number (Nickel)	Fig.	Dimensions mm		Captive center contact	Note
					A	B		
RG178 / RG196	2/50/S	R114 183 000		1	13.7	15.3	Yes	-
RG174 / RG316 / RG179	2.6/50+75/S	R114 185 000	N/A	2	-	-		Short version
		R114 186 000		1	13.7	15.3		-
		R114 186 100			15.1	15.4		Full crimp
		R114 187 000			13.7			-
RD316	2.6/50/D	R114 182 000						-
RG178 / RG196	2/50S	2105-1521-002	2105-7521-002	3	13.2	16		-
		2141-1521-002		4	12.7			-
RD178	2/50D	2105-1521-005	2105-7521-005	3	13.2			-
RG174 / RG316 / RG179	2.6/50S	2105-1521-003	2105-7521-003	3	13.2			-
		2141-1521-003	2141-7521-003	4	12.7		-	
RD316	2.6/50D	2105-1521-019	2105-7521-019	3	13.2		-	
		2141-1521-019	2141-7521-019	4	12.7		-	

Plugs and Jacks

RIGHT ANGLE PLUGS AND JACKS CLAMP TYPE FOR FLEXIBLE CABLES



Cable group	Cable group dia.	Part number (Gold)	Part number (Nickel)	Fig.	Dimensions mm		Captive center contact
					A	B	
RG178 / RG196	2/50/S	R114 163 000	N/A	1	19	13.7	Yes
	2.2/50/D	R114 163 420			16.7		
RG174 / RG316 / RG179	2.6/50+75/S	R114 165 000			19		
RG178 / RG197	2/50S	2005-1551-002	2005-7551-002	2	-	-	
		2041-1551-002	-	3	-	-	
RG174 / RG316 / RG179	2.6/50S	2005-1551-003	2005-7551-003	2	-	-	
		2041-1551-003	2041-7551-003	3	-	-	
RD316	2.6/50D	2005-1551-019	-	2	-	-	

RIGHT ANGLE PLUGS AND JACKS FOR SEMI RIGID CABLES

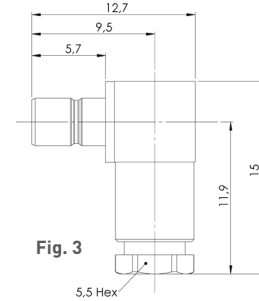
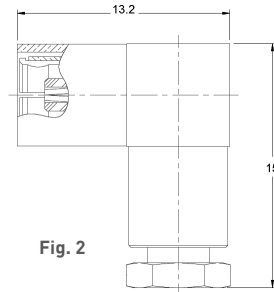
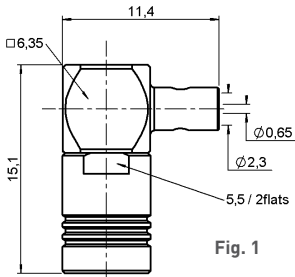

Cable group	Cable group dia.	Part number (Gold)	Part number (Nickel)	Fig.	Captive center contact	Note
RG405	.085"	R114 169 000	N/A	1	Yes	Cable bending required Solder type for semi rigid cable
		2005-1541-010	2005-7541-010	2		
		2041-1541-010	2041-7541-010	3		
RG402	.141"	2005-1541-009	2005-7541-009	2		Solder clamp
		2041-1541-009	-	3		

Jacks and Bulkhead Jacks

STRAIGHT JACKS CRIMP TYPE FOR FLEXIBLE CABLES

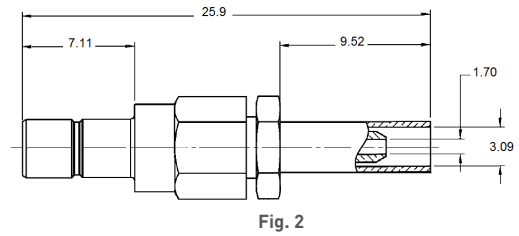
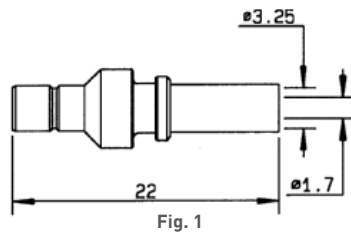

Cable group	Cable group dia.	Part number (Gold)	Part number (Nickel)	Fig.	Captive center contact	Note
RG174 / RG316 / RG179	2.6/50+75/S	R114 238 000	-	1	Yes	Full crimp
RG178 / RG197	2/50S	2001-1571-002	2001-7571-002	2		Crimp type
RD178	2/50D	2001-1571-005	-			
RG174 / RG316 / RG179	2.6/50S	2001-1571-003	2001-7571-003			
RD316	2.6/50D	2001-1571-019	2001-7571-019			

STRAIGHT BULKHEAD JACKS CRIMP TYPE FOR FLEXIBLE CABLES

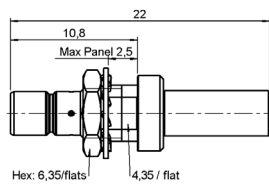

Fig. 1

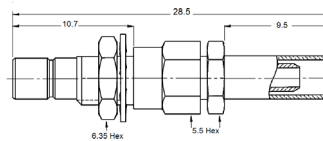

Fig. 2

Cable group	Cable group dia.	Part number (Gold)	Part number (Nickel)	Fig.	Captive center contact	Panel drilling	Note
RG174 / RG316 / RG179	2.6/50+75/S	R114 313 000	N/A	1	Yes	P08	Rear mount / Fill crimp
RG178 / RG197	2/50S	2003-1571-002	2003-7571-002	2			
RD178	2/50D	2003-1571-005	2003-7571-005				
RG174 / RG316 / RG179	2.6/50S	2003-1571-003	2003-7571-003				
RD316	2.6/50D	2003-1571-019	2003-7571-019				

Bulkhead Jacks

SMB

STRAIGHT BULKHEAD JACKS CLAMP TYPE FOR FLEXIBLE CABLES

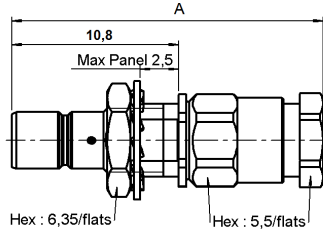

Fig. 1

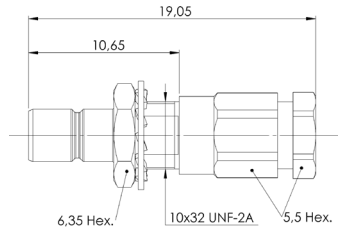

Fig. 2

Cable group	Cable group dia.	Part number (Gold)	Part number (Nickel)	Fig.	Dimensions A (mm)	Captive center contact	Panel drilling	Note
RG178 / RG196	2/50/S	R114 303 000	N/A	1	25.3	Yes	P08	Rear mount
		R114 303 133			20.1			
RG174 / RG316 / RG179	2.6/50+75/S	R114 305 000	25.3					
RG178 / RG197	2/50/S	2003-1551-002	2003-7551-002	2	-			
RD178	2/50/D	2003-1551-005	-		-			
RG174 / RG316 / RG179	2.6/50/S	2003-1551-003	2003-7551-003		-			
RD316	2.6/50/D	2003-1551-019	-		-			

STRAIGHT BULKHEAD JACK SOLDER TYPE FOR SEMI-RIGID CABLE

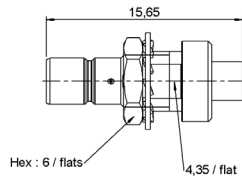

Fig. 1

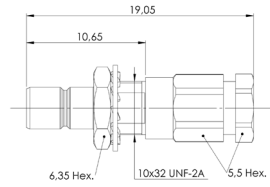
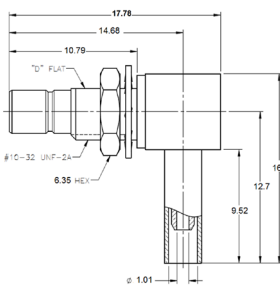

Fig. 2

Cable group	Cable group dia.	Part number (Gold)	Part number (Nickel)	Fig.	Captive center contact	Panel drilling	Note
RG405	.085"	R114 222 000	-	1	Yes	P08	-
		2003-1541-010	2003-7541-010	2			Solder clamp type
RG402	.141"	2003-1541-009	-				

RIGHT ANGLE BULKHEAD CRIMP TYPE FOR FLEXIBLE CABLES



Cable group	Cable group dia.	Part number (Gold)	Part number (Nickel)	Captive center contact	Panel drilling
RG178 / RG197	2/50S	2106-1521-002	2106-7521-002	Yes	P08
RD178	2/50D	2106-1521-005	-		
RG174 / RG316 / RG179	2.6/50/S	2106-1521-003	2106-7521-003		
RD316	2.6/50/D	2106-1521-019	2106-7521-019		

Receptacles

STRAIGHT FLANGE RECEPTACLES (male center contact)

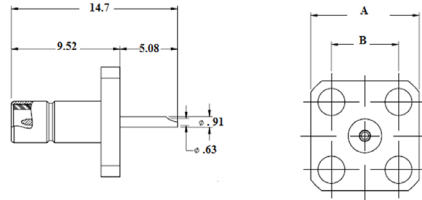
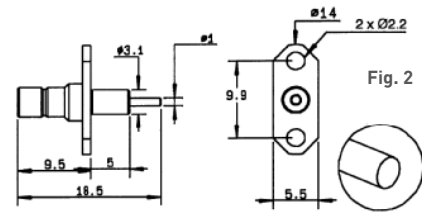
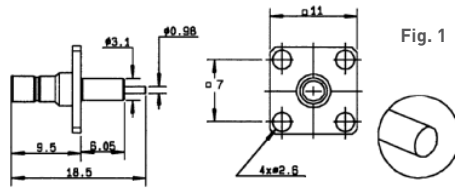
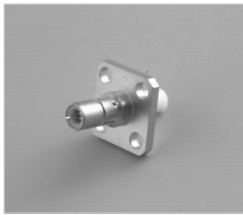

Fig. 3

Part number (Gold)	Part number (Nickel)	Fig.	Dimensions mm		Captive center contact	Panel drilling	Note
			A	B			
R114 413 000	N/A	1	-	-	No	P01	Square flange / Extended dielectric
R114 450 000		2	-	-		P06	2 hole glange / Extended dielectric / Unit packaging
2484-1511-000		3	9.5	5.9	Yes	-	2.36mm hole dia.
2486-1511-000	2486-7511-000	12.7	8.6	-			

STRAIGHT BULKHEAD RECEPTACLES (male center contact)

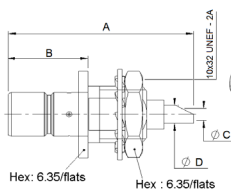

Fig. 1

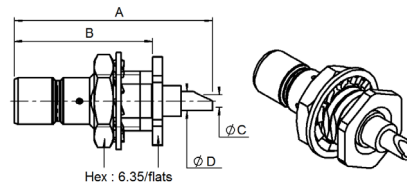

Fig. 2

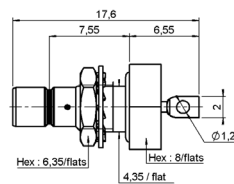

Fig. 3

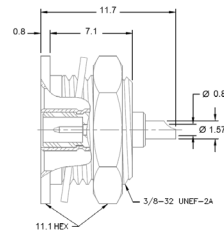
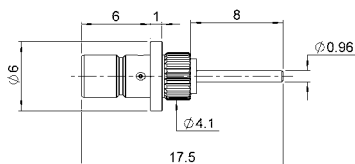

Fig. 4

Part number (Gold)	Part number (Nickel)	Fig.	Dimensions mm				Captive center contact	Panel drilling	Note
			A	B	C	D			
R114 553 000	N/A	1	15.7	6.7	1	1.5	Yes	P08	Front mount
R114 554 000		2		10.9					Rear mount
R114 603 000		3	-	-	-	Hermetically sealed			
2004-1511-000	2004-7511-000	2	15.5	10.8	0.9	1.6			Rear mount / Solder pot contact
2014-1511-000	2014-7511-000	4	-	-	-	-			Recessed front mount / Solder pot contact
2019-1511-000	2019-7511-000	1	15.5	5.9	0.9	1.6			Front mount / Solder pot contact

Receptacles

STRAIGHT PRESS IN RECEPTACLE (male)



Part number	Captive center contact	Panel drilling	Finish
R114 504 225	Yes	P10	Nickel

RIGHT ANGLE BULKHEAD RECEPTACLES (male center contact)

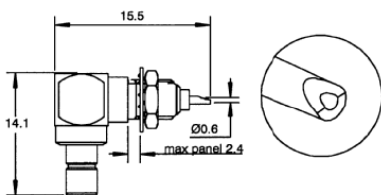

Part number	Captive center contact	Panel drilling	Finish	Note
R114 670 000	Yes	P08	Gold	Solder pot contact
2012-1511-000			Nickel	
2012-7511-000				

STRAIGHT PCB RECEPTACLES (male and female)

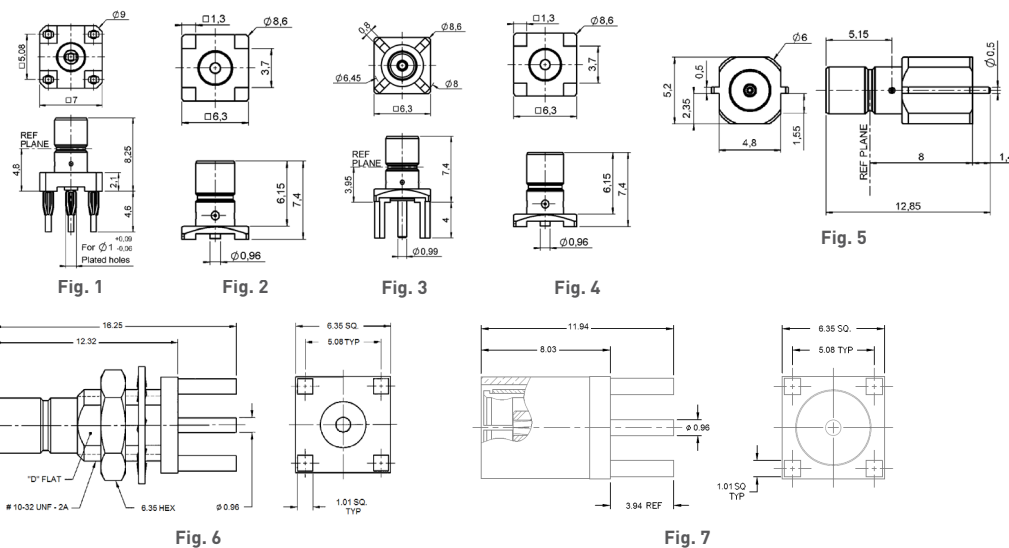

Part number (Gold)	Part number (Nickel)	Fig.	Captive center contact	Assembly instructions	Panel drilling	Note	
R114 416 020	N/A	1	Yes	-	P02	Press fit pins	
R114 423 000		5		-	-	SMT edge card	
R114 424 000		2		M01	-	-	SMT
R114 424 100							SMT / Tape & Reel 100 pieces
R114 425 000		4		-	P05	Female plug	
R114 426 000		-		-	P03	-	
2009-1511-000		2009-7511-000		3	-	-	P04
2009-1511-050	2009-7511-050	-	-	-	-	Standoff legs	
2025-1511-000	2025-7511-000	7	-	-	-	No standoff	
2109-1511-000	2109-7511-000	6	-	-	-		

Receptacles

RIGHT ANGLE PCB RECEPTACLES (male center contact)

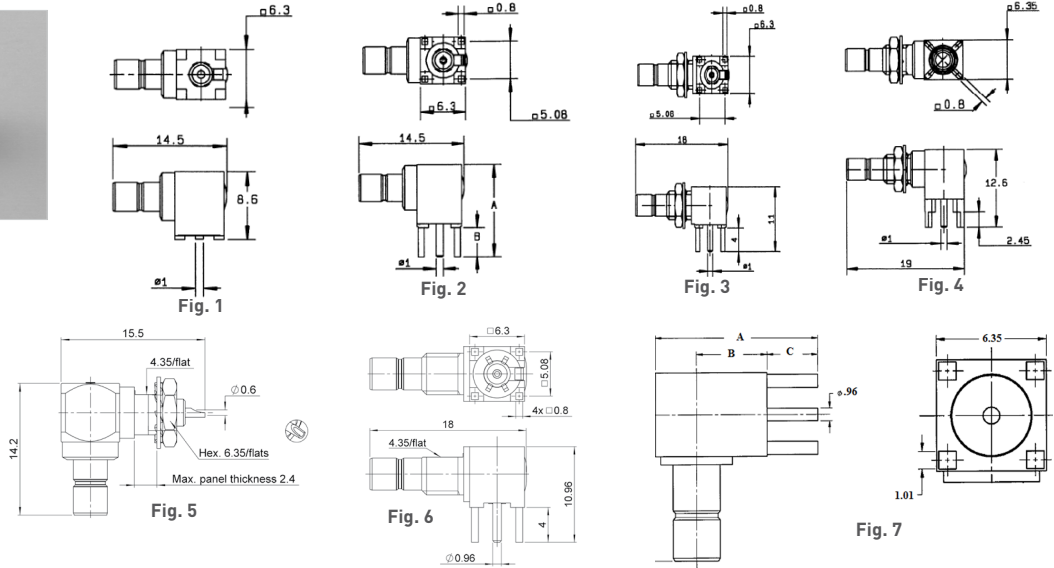

Part number (Gold)	Part number (Nickel)	Fig.	Dimensions mm				Captive center contact	Assembly instructions	Panel drilling	Note
			A	B	C	D				
R114 664 000	N/A	1	-	-	-	-	Yes	M01	Packaging 100/reel	
R114 664 120									SMT / Packaging 500/reel	
R114 665 000		2	12.6	4	-	-		-	P03	-
R114 665 020								Packaging unit Rear mount		
R114 673 020		3	-	-	-	-		-	-	-
R114 673 120								-		
R114 670 000		4	-	-	-	-		-	-	-
R114 673 823					-					
2010-1511-000	2010-7511-000	7	10.9	3.8	3.9	12.7	-	P04	-	
2010-1511-002	2010-7511-002		12.7	5.5		14.2	-	-		

Adapters

IN SERIES ADAPTERS

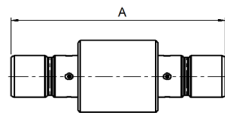

Fig. 1

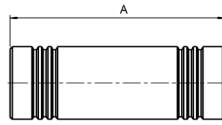

Fig. 2

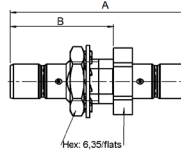

Fig. 3

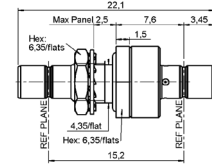

Fig. 4

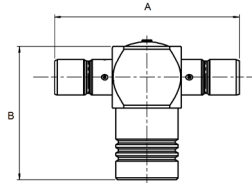

Fig. 5

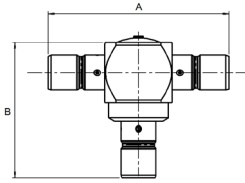

Fig. 6

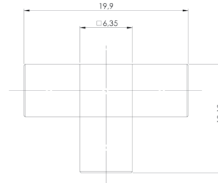

Fig. 7

Part number (Gold)	Part number (Nickel)	Fig.	Dimensions		Captive center contact	Panel drilling	Note
			A	B			
R114 703 000	N/A	1	-	-	Yes	-	Male - Male
R114 704 000		2	19	-		-	Female - Female
R114 720 000		3	-	11		P08	Bulkhead male - Male
R114 753 000		4	-	-			Hermetically sealed male - Male
R114 780 000		5	19	14		-	Tee female / Male - Male
R114 781 000		6	-	12.7		-	Tee male / Male - Male
5207-1501-000	5207-7501-000	3	17.5	10.7		-	Bulkhead male - Male
5213-1501-000	5213-7501-000	1	-	-		-	Male - Male
5215-1501-000	5215-7501-000	5	19	12.9		-	Tee female / Male - Male
5216-1501-000	5216-7501-000	2	17.5	-		-	Female - Female
5208-1501-000	5208-7501-000	7	-	-		-	Tee female / Female - Female

Introduction

Radiall offers **SMB LOCK** plugs with a 2-step connection system:

- 1 **Snap** the plug on the male connector (fig. 1)
- 2 **Lock** by pushing down the coupling nut (fig. 2)

This range:

- Is **intermateable** with the standard **SMB** male connectors
- Benefits from a low intermodulation
- Replaces the standard **SMB** and screw-on connectors in all applications requiring:
 - A fast connection
 - A reliable lock-on connection
 - Long durability
- Possibility to visually control the locking system

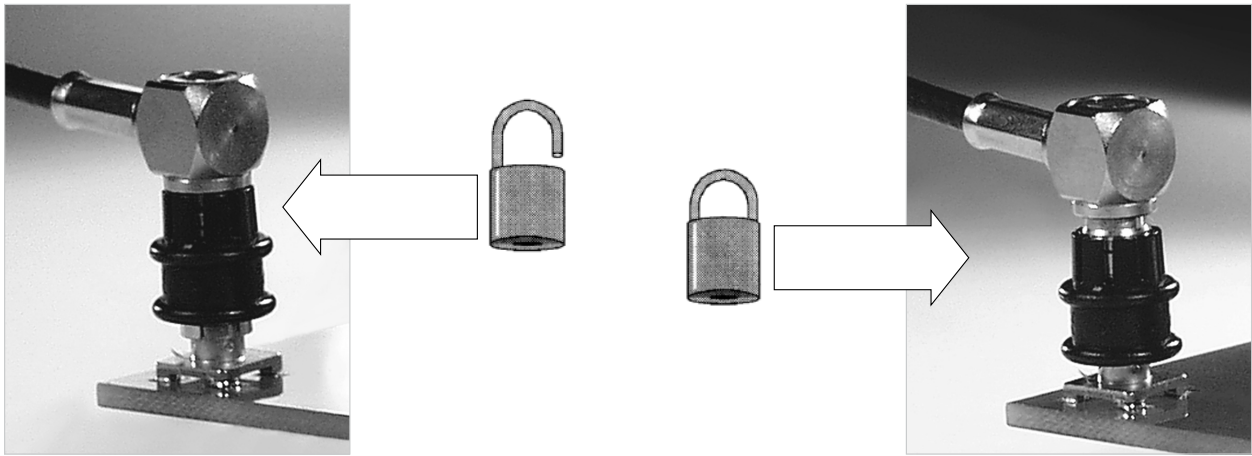
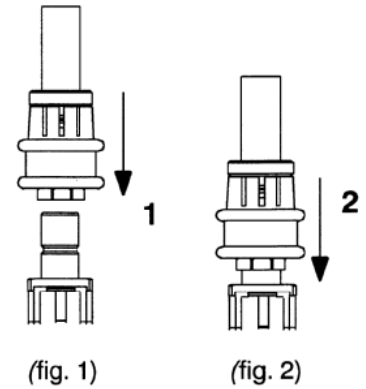

- The connector allows a 360° cable rotation
- Coupling nut

The coupling nut is made with POM (halogen free). Its standard color is black.

Interface

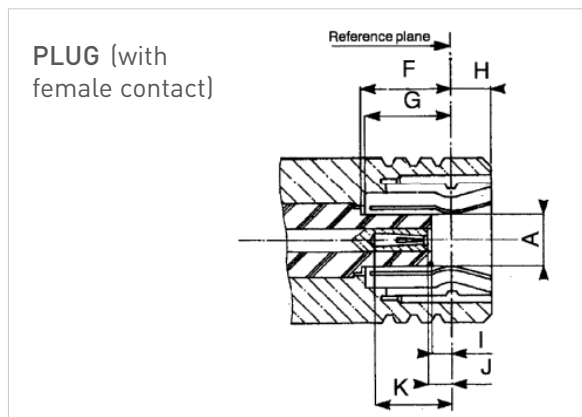

Letter	mm		inch	
	min.	max.	min.	max.
A DIA	-	2.06	-	.081
F	3.58	-	.141	-
G	3.58	-	.141	-
H	-	1.63	-	.064
I	0.18	-	.007	-
J	0.18	0.94	.007	.037
K	2.97	-	.117	-

Characteristics

Test / Characteristics	Values / Remarks
------------------------	------------------

ELECTRICAL CHARACTERISTICS

Impedance	50Ω		
Operating frequency	DC to 4 GHz		
Typical V.S.W.R.		2 GHz	4 GHz
• Straight models	.085" ∅ 2.6/50	1.15 1.20	1.20 1.25
• Right angle models	.085" ∅ 2.6/50	1.05 1.15	1.15 1.25
RF Insertion loss		0.20vF (GHz)	
• Straight models	.085" ∅ 2.6/50	0.25vF (GHz)	
• Right angle models	.085" ∅ 2.6/50	0.25vF (GHz)	
Testing voltage (V RMS)	.085" ∅ 2.6/50	750 1000	
Working voltage (V RMS)	.085" ∅ 2.6/50	335 335	
Insulation resistance (MΩ)	1000		

MECHANICAL CHARACTERISTICS

Life	500 matings min		
Cable retention force	.085" ∅ 2.6/50 ∅ 5/50/S	220 N 110 N 110 N	
Coupling nut retention force	50 N min		
Vibrations	MIL STD 202 F method 240D, condition B		

ENVIRONMENTAL CHARACTERISTICS

Temperature range	-35°C / + 125°C
-------------------	-----------------

MATERIALS AND PLATING

	Material	Plating
Bodies	Brass	BBR
Center contact	Beryllium copper	Gold
Outer contact	Bronze	-
Insulator	PTFE	-
Coupling nut	POM (halogen free)	-

Standard packaging: 100 pieces (For unit packaging, add "W" after the P/N).

Plugs

STRAIGHT PLUG FULL CRIMP TYPE FOR FLEXIBLE CABLES

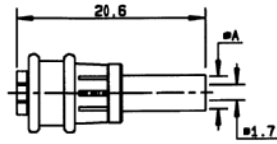
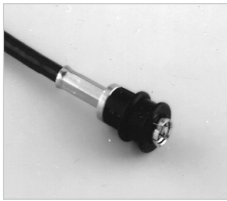

Cable group	Cable group dia	Part number	Dimensions A (mm)	Captive center contact
RG174 / RG188 / RG316	2.6/50/S	R117 082 807	3.25	Yes

RIGHT ANGLE PLUG CRIMP TYPE FOR FLEXIBLE CABLES

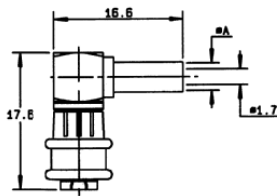
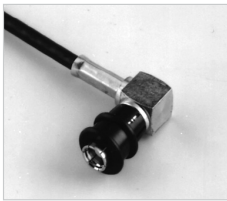

Cable group	Cable group dia	Part number	Dimensions A (mm)	Captive center contact
RG174 / RG188 / RG316	2.6/50/S	R117 186 807	3.25	Yes

Receptacles

- Lower mating/unmating force (from 2.5 N to 6N)
- Receptacles intermateable with SMB connectors
- Gold finish

The SMB limited detent connectors have the same electrical characteristics as standard SMB connectors.

BULKHEAD PLUG RECEPTACLE (rear fixing)

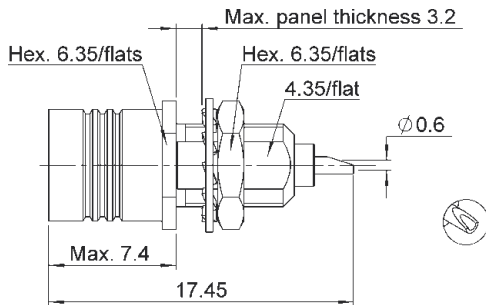

Part number	Panel drilling	Finish
R115 556 000	P08	Gold

SMB Limited Detent (SMB-A)

STRAIGHT PCB RECEPTACLES (female center contact)

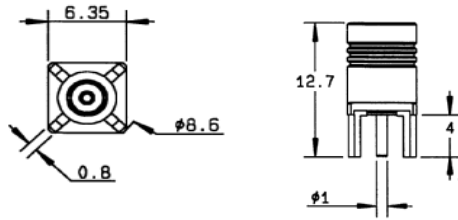

Part number	Captive center contact	Panel drilling	Finish	Packaging
R115 427 000	Yes	P05	Gold	Unit

RIGHT ANGLE PCB RECEPTACLE (female center contact)

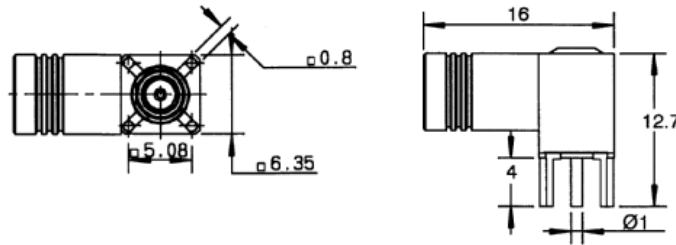
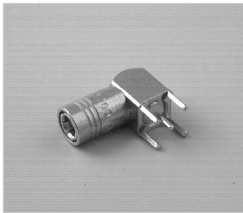

Part number	Captive center contact	Panel drilling	Finish	Packaging
R115 666 000	Yes	P04	Gold	Unit

SMB Slide-On (SUBGLIS)

Slide-on connectors (mating/unmating force: 2.2 N to 4.9 N)

The SMB slide-on connectors are completely intermateable with standard SMB and SMB limited detent connectors and can be used for **test applications**. The SMB slide-on connectors have the same electrical characteristics as standard SMB connectors.

PCB RECEPTACLES

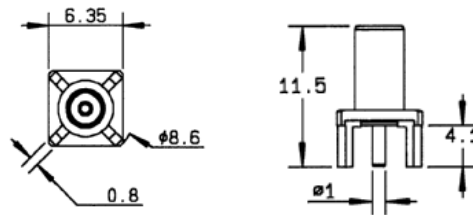
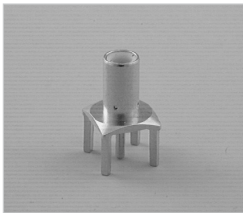

Part number	Captive center contact	Panel drilling	Finish	Packaging	Note
R116 426 000	Yes	P03	Gold	Unit	Male center contact

Panel Drilling

P01

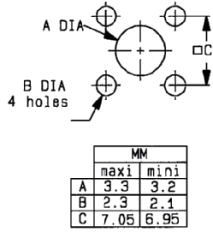

P02

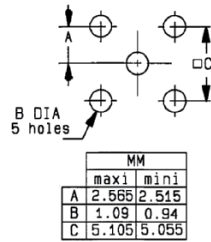

P03

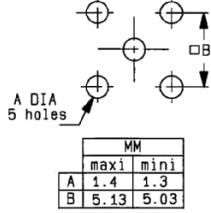

P04

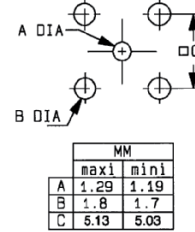

P05

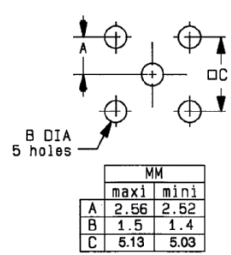

P06

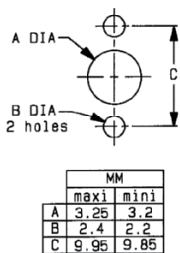

P07

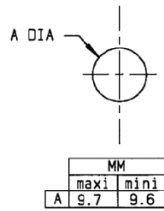

P08

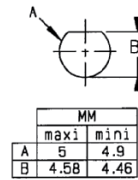

P09

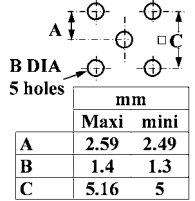

P10

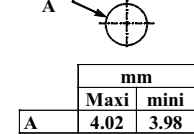

Assembly Instructions

M01

Part number
R114 423 000

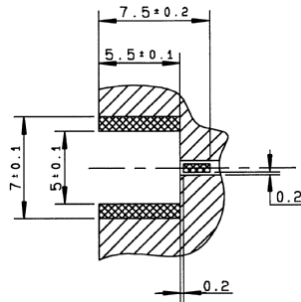

Part number
R114 424 000
R114 424 100
R114 664 000
R114 664 120

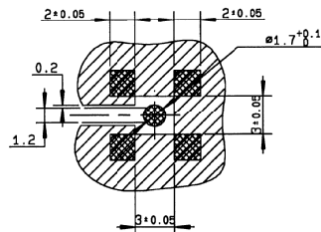

Video shadow

Part number
R113 423 000

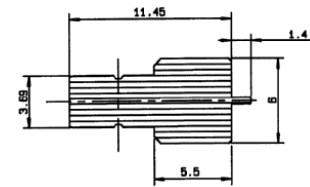

Part number
R114 424 000
R114 424 100

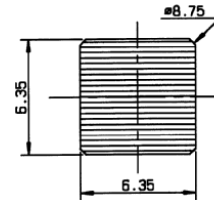

Part number
R114 664 000
R114 664 120

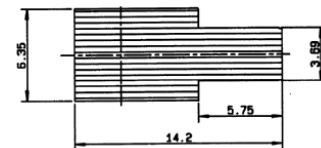

Vaccum nozzle dimensions:

Part number
R114 424 000

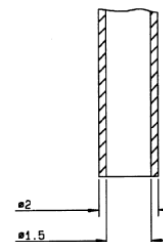

Introduction



50Ω	DC - 10 GHz
-----	-------------

GENERAL

- Subminiature coaxial connectors
- Screw-on coupling
- Plugs have female contacts
- Jacks have male contacts
- Low weight
- Reduced outline dimensions

APPLICABLE STANDARDS

- MIL-C-39012

APPLICATIONS

- Civil and military telecommunications
- Aeronautics
- Missiles
- Edge mounting applications

Interface

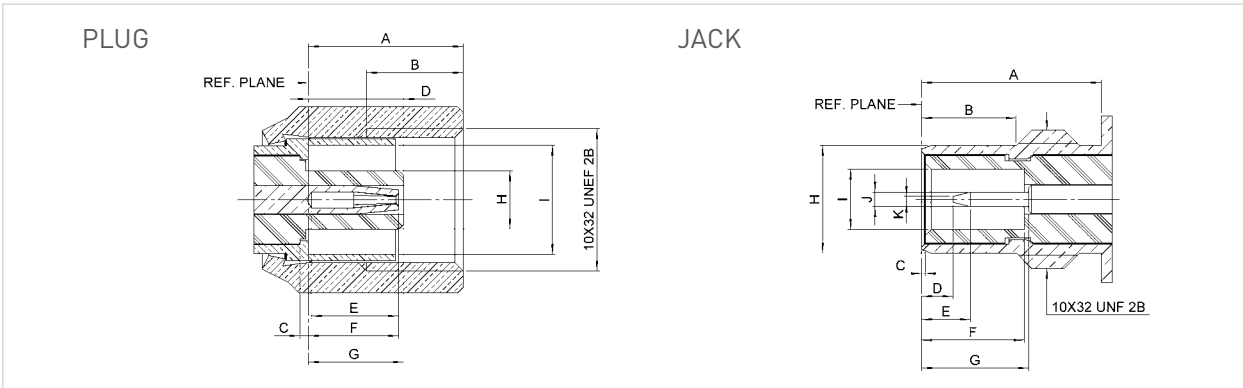

Letter	mm		inch	
	min.	max.	min.	max.
A	5.14	5.55	.202	.219
B	3.20	4.20	.126	.165
C	0.25	0.35	.010	.014
D	2.95	3.00	.116	.118
E	2.80	3.20	.110	.126
F	2.80	3.40	.110	.134
G	3.15	3.40	.124	.134
H	2.00	2.05	.079	.081
I	3.75	3.80	.148	.150

Letter	mm		inch	
	min.	max.	min.	max.
A	6.00	6.20	.236	.244
B	3.15	3.35	.124	.132
C	0.05	0.20	.002	.008
D	0.65	1.50	.026	.059
E	1.30	2.05	.051	.081
F	3.40	3.71	.134	.146
G	3.40	3.95	.134	.156
H	3.65	3.69	.144	.145
I	2.08	2.13	.082	.084
J	0.48	0.52	.019	.020
K	-	0.20	-	.008

Characteristics

Test / Characteristics	MIL-C-39012 paragraph	Values / Remarks
------------------------	-----------------------	------------------

ELECTRICAL CHARACTERISTICS

Impedance	-	50Ω
Frequency range	-	DC - 10 GHz
V.S.W.R. (typ.) • Straight • Right angle	3-14	2/50 1.25 + 0.04 F (GHz) 1.40 + 0.06 F (GHz)
		2.6/50 1.20 + 0.04 F (GHz) 1.30 + 0.04 F (GHz)
Insertion loss • Straight • Right angle	3-27	0.25 dB max. at 4 GHz 0.5 dB max. at 4 GHz
RF leakage	3-26	-60 dB min between 2 and 3 GHz
Insulation resistance	3-11	1000 MΩ min
Contact resistance • Center contact (mΩ) • Outer contact (mΩ)	3-16	Initial 6 1
		After environment 8 1.5
Voltage rating (volts RMS) • At sea level • At 70000 ft (21000 m)	3-16	2/50 250 V rms 60 V rms
		2.6/50 335 V rms 85 V rms
Dielectric withstanding voltage • At sea level • At 70000 ft (21000 m)	3-17	2/50 750 V rms 185 V rms
		2.6/50 1000 V rms 250 V rms
RF high potential withstanding voltage (Frequency 5 MHz) • At sea level	3-23	2/50 500 V rms
		2.6/50 700 V rms

MECHANICAL CHARACTERISTICS

Durability	3-15	500 matings
Force to engage and disengage	3-5-1	torque: 16 inch-ounces max - 11.3 Ncm
Mating torque	-	35 to 50 inch-ounces - 25 to 35 Ncm
Coupling nut proof torque	-	100 inch-ounces - 71 Ncm
Coupling nut retention force	3-25	35 lbs min - 156 N min
Cabling retention force	3-24	2/50 13 lbs - 58 N
		2.6/50 25 lbs - 110 N
Contact captivity	-	Axial force: 4 lbs - 18 N torque: not applicable

ENVIRONMENTAL CHARACTERISTICS

Operating temperature range • Standard models and hermetic • Models for semi-rigid cables	-	-65°C / +165°C -65°C / +105°C
Temperature cycling	-	MIL-STD-202, method 102, condition C
Thermal shock	3-20	MIL-STD-202, method 107, condition B
High temperature test	-	MIL-STD-202, method 108
Corrosion (salt spray)	3-13	MIL-STD-202, method 101, condition B, 5%
Vibration	3-18	MIL-STD-202, method 204, condition D, 20g
Shock	3-19	MIL-STD-202, method 213, condition C, 100g
Moisture resistance	3-21	not applicable
Barometric pressure	3-22	MIL-STD-202, method 105, condition C
Hermetic test	-	Down to 10 ⁻⁶ mm Hg (Torr) Leak rate <1 x 10 ⁻⁶ atm/cm ³ /sec

MATERIALS AND PLATING

	Material	Plating
Bodies and male contacts	Brass, half hard per QQ-B-626	Gold to satisfy the corrosion requirements (bodies)
Female contacts and interfaces	Beryllium copper per QQ-C-530	Gold (Center contact)
Ferrules	Brass	-
Insulators	PTFE teflon	-
Gaskets	Silicone rubber	-

All dimensions are given in mm.

Plugs and Jack

STRAIGHT PLUGS

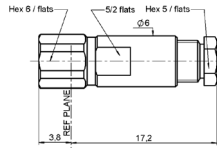

Fig. 1

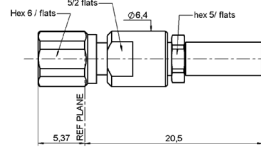

Fig. 2

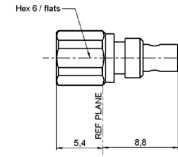

Fig. 3

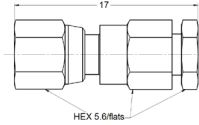

Fig. 4

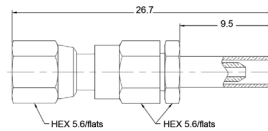

Fig. 5

Cable group	Cable group dia	Part number (Gold)	Part number (Nickel)	Fig.	Note
RG178 / RG196	2/50/S	R112 003 000	N/A	1	Clamp type
RG174 / RG316 / RG179	2.6/50+75/S	R112 005 000			
		R112 075 000			
RG405	.085"	R112 053 000		3	Solder type
RG178 / RG196	2/50/S	1002-1571-002	1002-7571-002	5	Crimp type
		1002-1551-002	1002-7551-002	4	Clamp type
RD178	2/50/D	1002-1551-005	1002-7551-005	5	Crimp type
		1002-1571-005	1002-7571-005	5	Crimp type
RG174 / RG316 / RG179	2.6/50/S	1002-1551-003	1002-7551-003	4	Clamp type
		1002-1571-003	1002-7571-003	5	Crimp type
RD316	2.6/50/D	1002-1551-019	1002-7551-019	4	Clamp type
		1002-1571-019	1002-7571-019	5	Crimp type
RG405	.085"	1002-1541-010	1002-7541-010	4	Solder clamp
RG402	.141"	1002-1541-009	1002-7541-009		

RIGHT ANGLE PLUGS

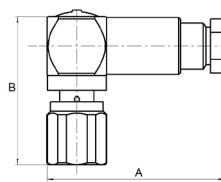

Fig. 1

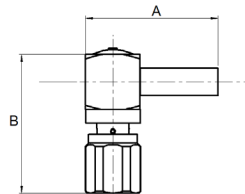

Fig. 2

Cable group	Cable group dia	Part number (Gold)	Part number (Nickel)	Fig.	Dimensions mm		Note
					A dia	B dia	
RG174 / RG316 / RG179	2.6/50+75/S	R112 165 000	N/A	1	19	15.9	Crimp type
RG178 / RG196	2/50	R112 183 000			16	15.5	
RG174 / RG316 / RG179	2.6/50+75/S	R112 186 000		2	15.3	15.9	
RG178 / RG196	2/50/S	1005-1551-002	1005-7551-002	1	14.9	13.9	Clamp type
		1105-1521-002	1105-7521-002	2	16		Crimp type
RD178	2/50/D	1005-1551-005	1005-7551-005	1	14.9		Clamp type
		1105-1521-005	1105-7521-005	2	16		Crimp type
RG174 / RG316 / RG179	2.6/50/S	1005-1551-003	1005-7551-003	1	14.9		Clamp type
		1105-1521-003	1105-7521-003	2	16		Crimp type
RD316	2.6/50/D	1005-1551-019	1005-7551-019	1	14.9		Clamp type
		1105-1521-019	1105-7521-019	2	16		Crimp type
RG405	.085"	1005-1541-010	1005-7541-010	1	14.9		Solder clamp
RG402	.141"	1005-1541-009	1005-7541-009				

Jacks and Receptacles

STRAIGHT JACK

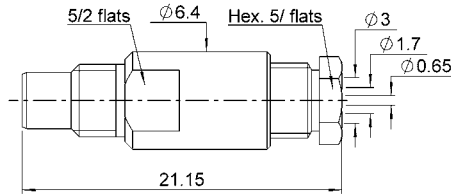

Fig. 1

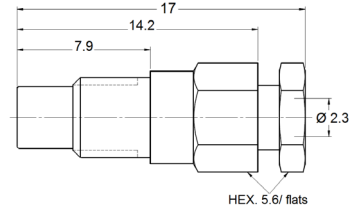

Fig. 2

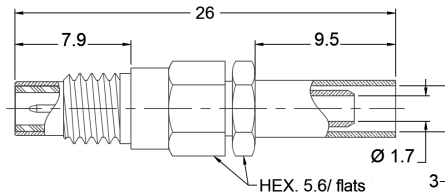

Fig. 3

Cable group	Cable group dia	Part number (Gold)	Part number (Nickel)	Note
RG174 / RG316 / RG179	2.6/50+75/S	R112 205 000	-	Clamp type
RG178 / RG196	2/50/S	1001-1551-002	1001-7551-002	
RD178	2/50/D	1001-1551-005	1001-7551-005	Clamp type
		1001-1571-005	1001-7571-005	Crimp type
RG174 / RG316 / RG179	2.6/50/S	1001-1551-003	1001-7551-003	Clamp type
		1001-1571-003	1001-7571-003	Crimp type
RD316	2.6/50/D	1001-1551-019	1001-7551-019	Clamp type
		1001-1571-019	1001-7571-019	Crimp type
RG405	.085"	1001-1571-010	1001-7571-010	Solder clamp
RG402	.141"	1001-1571-009	1001-7571-009	

BULKHEAD STRAIGHT AND RIGHT ANGLE JACKS

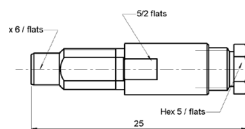

Fig. 1

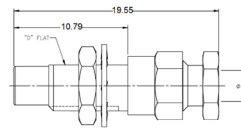

Fig. 2

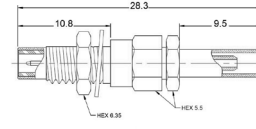

Fig. 3

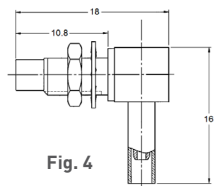

Fig. 4

Cable group	Cable group dia	Part number (Gold)	Part number (Nickel)	Fig.	Panel drilling	Note
RG178 / RG196	2/50/S	R112 303 000	-	1	P03	-
RG174 / RG316 / RG179	2.6/50+75/S	R112 305 000	-			
RG178 / RG196	2/50/S	1003-1551-002	1003-7551-002	2		Clamp type
		1003-1571-002	1003-7571-002	3		Crimp type
		1006-1551-002	1006-7551-002	4		Clamp type
		1106-1521-002	1106-7521-002			Crimp type
RD178	2/50/D	1003-1551-005	1003-7551-005	2		Clamp type
		1003-1571-005	1003-7571-005	3		Crimp type
		1006-1551-005	1006-7551-005	4		Clamp type
		1106-1521-005	1106-7521-005			Crimp type
RG174 / RG316 / RG179	2.6/50/S	1003-1551-003	1003-7551-003	2		Clamp type
		1003-1571-003	1003-7571-003	3		Crimp type
		1006-1551-003	1006-7551-003	4	Clamp type	
		1106-1521-003	1106-7521-003		Crimp type	

Jacks and Receptacles

BULKHEAD STRAIGHT AND RIGHT ANGLE JACKS (CONTINUED)

Cable group	Cable group dia	Part number (Gold)	Part number (Nickel)	Fig.	Panel drilling	Note		
RD316	2.6/50/D	1003-1551-019	1003-7551-019	2	P03	Clamp type		
		1003-1571-019	1003-7571-019	3		Crimp type		
		1006-1551-019	1006-7551-019	4		Clamp type		
		1106-1521-019	1106-7521-019			Crimp type		
RG405	.085"	1003-1541-010	1003-7541-010	2		P03	Solder clamp	
		1006-1541-010	1006-7541-010	4				
RG402	.141"	1003-1541-009	1003-7541-009	2	P03			Solder clamp
		1006-1541-009	1006-7541-009	4				

SQUARE FLANGE RECEPTACLES

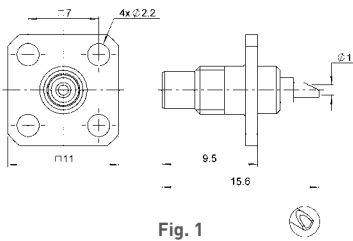

Fig. 1

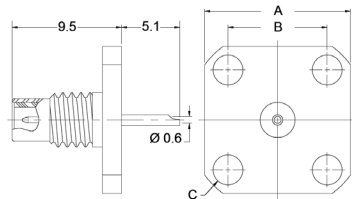

Fig. 2

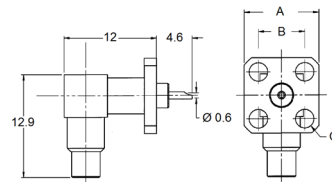

Fig. 3

Part number (Gold)	Part number (Nickel)	Fig.	Dimensions (mm)			Panel drilling
			A	B	C	
R112 403 000	N/A	1	-	-	-	P01
1484-1511-000	1484-7511-000	2	9.5	5.9	2.4	-
1486-1511-000	1486-7511-000		12.7	8.6	2.6	-
1490-1511-000	1490-7511-000	3	-	-	-	-
1488-1511-000	1488-7511-000		9.5	5.9	2.4	-

BULKHEAD RECEPTACLES WITH SOLDER POT CONTACT

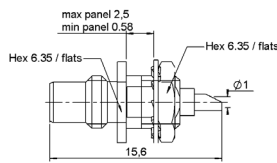

Fig. 1

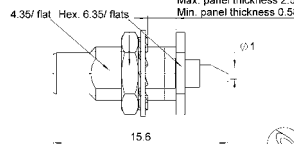

Fig. 2

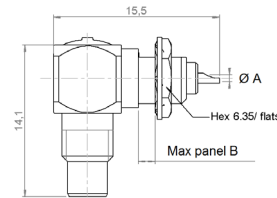

Fig. 3

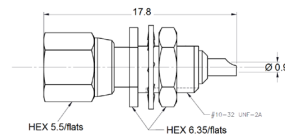

Fig. 4

Part number (Gold)	Part number (Nickel)	Fig.	Dimensions (mm)		Panel drilling	Note
			A	B		
R112 553 000	N/A	1	-	-	P03	Front mount
R112 554 000		2	-	-		Rear mount
R112 670 000		3	0.6	1.55		Front mount
1004-1511-000	1004-7511-000	2	-	-		Rear mount
1019-1511-000	1019-7511-000	1	-	-		Front mount
1012-1511-000	1012-7511-000	3	0.9	2.4		
1017 1511-000	1017 7511-000	4	-	-		

Receptacles and Adapters

PCB RECEPTACLES

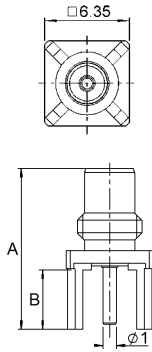
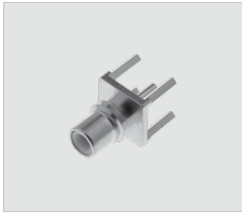

Fig. 1

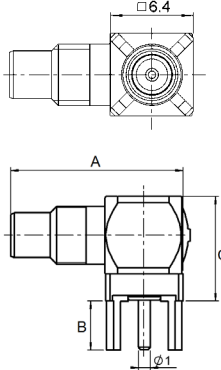

Fig. 2

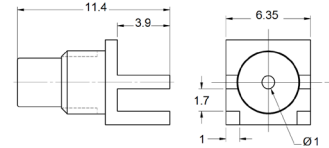

Fig. 3

Part number (Gold)	Part number (Nickel)	Fig.	Dimensions (mm)			Panel drilling	Note
			A	B	C		
R112 426 000	N/A	1	11.8	4.4	-	P02	Standoff legs
R112 665 000		2	14.2	-	12.7		
1009-1511-000	1009-7511-000	1	11.4	4	-	P04	No standoff
1010-1511-000	1010-7511-000	2	14		7		
1010-1511-001	1010-7511-001		8.8		P04 + P03	No standoff, bulkhead type	
1109-1511-000	1109-7511-000	1	16.3				
1110-1511-000	1110-7511-000	2	18	7	P04	End launch type	
1009-1511-005	1009-7511-005	3	-	-			-

IN SERIES ADAPTERS

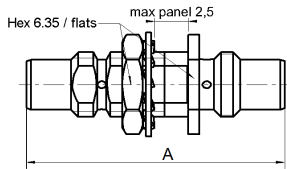

Fig. 1

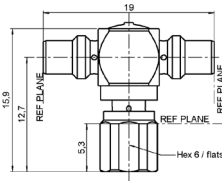
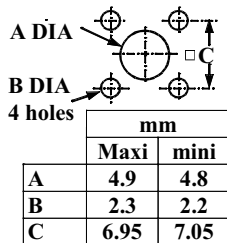

Fig. 2

Part number (Gold)	Fig.	Dimensions A (mm)	Panel drilling	Note
R112 720 000	1	19	P03	Male - Male bulkhead
R112 780 000	2	-	-	Tee male - Male / Female
5822-1501-000	1	17.5	P03	Female - Female

Panel Drilling

P01



P02

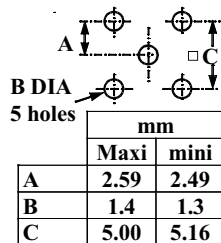

P03

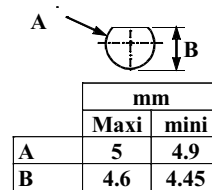

P04

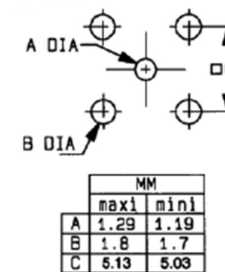

NOTE



NOTE

