

FEATURES

16-bit resolution, 200 MSPS input data rate
IMD 90 dBc @10 MHz
Noise spectral density (NSD): -164 dBm/Hz @ 10 MHz
WCDMA ACLR = 80 dBc @ 40 MHz IF
DNL = ±0.3 LSB
INL = ±0.6 LSB
Selectable 2×/4×/8× interpolation filters
Selectable $f_{DAC}/2$, $f_{DAC}/4$, $f_{DAC}/8$ modulation modes
Single- or dual-channel signal processing
Selectable image rejection Hilbert transform
Flexible calibration engine
Direct IF transmission features
Serial control interface
Versatile clock and data interface
3.3 V-compatible digital interface
On-chip 1.2 V reference
80-lead, thermally enhanced, TQFP_EP package

APPLICATIONS

Base stations: multicarrier WCDMA, GSM/EDGE, TD-SCDMA, IS136, TETRA
Instrumentation
RF signal generators, arbitrary waveform generators
HDTV transmitters
Broadband wireless systems
Digital radio links
Satellite systems

PRODUCT HIGHLIGHTS

- 16-bit, high speed, interpolating TxDAC+.
- 2×/4×/8× user-selectable interpolating filter. The filter eases data rate and output signal reconstruction filter requirements.
- 200 MSPS input data rate.
- Ultra high speed, 500 MSPS DAC conversion rate.
- Flexible clock with single-ended or differential input. CMOS, 1 V p-p sine wave, and LVPECL capability.
- Complete CMOS DAC function. It operates from a 3.1 V to 3.5 V single analog (AVDD) supply, 2.5 V digital supply, and a 3.3 V digital (DRVDD) supply. The DAC full-scale current can be reduced for lower power operation, and a sleep mode is provided for low power idle periods.
- On-chip voltage reference. The AD9786 includes a 1.20 V temperature-compensated band gap voltage reference.
- Multichip synchronization. Multiple AD9786 DACs can be synchronized to a single master AD9786 to ease timing design requirements and optimize image reject transmit performance.

FUNCTIONAL BLOCK DIAGRAM

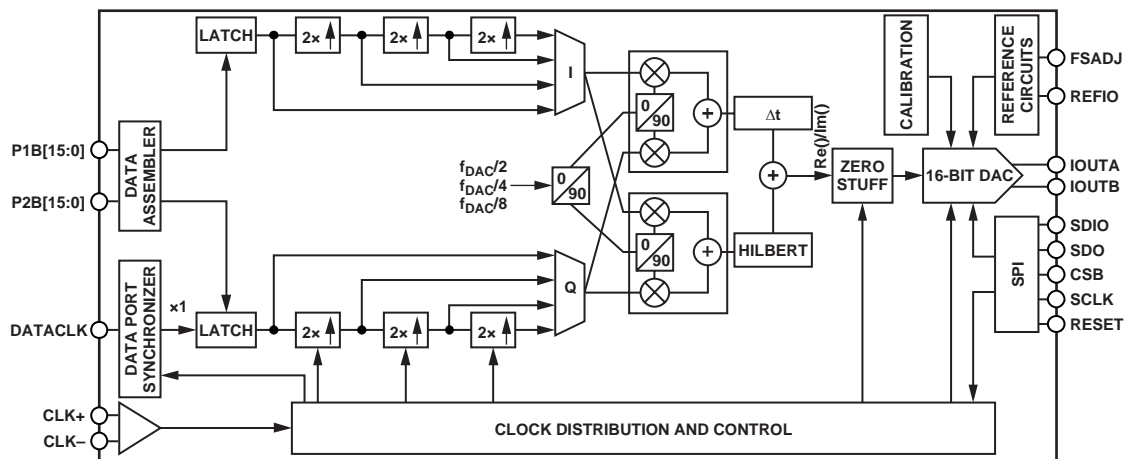

Figure 1.

Rev. B

Information furnished by Analog Devices is believed to be accurate and reliable. However, no responsibility is assumed by Analog Devices for its use, nor for any infringements of patents or other rights of third parties that may result from its use. Specifications subject to change without notice. No license is granted by implication or otherwise under any patent or patent rights of Analog Devices. Trademarks and registered trademarks are the property of their respective owners.

TABLE OF CONTENTS

Features	1	General Operation of the Serial Interface.....	20
Applications.....	1	Serial Interface Port Pin Descriptions	20
Product Highlights	1	MSB/LSB Transfers	21
Functional Block Diagram	1	Notes on Serial Port Operation	21
Revision History	3	Mode Control (via Serial Port)	22
General Description	4	Digital Filter Specifications	26
Specifications.....	5	Digital Interpolation Filter Coefficients.....	26
DC Specifications	5	Clock/Data Timing	27
Dynamic Specifications	6	Real and Complex Signals.....	32
Digital Specifications	7	Modulation Modes.....	33
Absolute Maximum Ratings.....	8	Power Dissipation.....	38
Thermal Resistance	8	Hilbert Transform Implementation.....	40
ESD Caution.....	8	Operating the AD9786 Rev. F Evaluation Board	44
Pin Configuration and Function Descriptions.....	9	Power Supplies.....	44
Clock	9	PECL Clock Driver	44
Analog.....	10	Data Inputs.....	45
Data	10	Serial Port.....	45
Serial Interface	11	Analog Output.....	45
Terminology	12	Outline Dimensions	55
Typical Performance Characteristics	14	Ordering Guide	55
Serial Control Interface.....	20		

REVISION HISTORY**10/05—Rev. A to Rev. B**

Updated Format.....	Universal
Changes to Figure 1.....	1
Changes to Table 2	6
Changes to Table 3	7
Changes to External Sync Mode Section	31
Updated Outline Dimensions.....	58
Changes to Ordering Guide.....	58

2/05—Rev. 0 to Rev. A

Changed DRVDD Supply Range.....	Universal
Changes to DC Specifications	4
Changes to Dynamic Specifications	5
Changes to Digital Specifications.....	6
Changes to Absolute Maximum Ratings.....	7
Change to Figure 2	8
Replaced Figure 13	14
Replaced Figure 14	14
Replaced Figure 16	15
Replaced Figure 21	16
Replaced Figure 22	16

Replaced Figure 26.....	16
Replaced Figure 27.....	17
Changes to Table 15	22
Change to Figure 44.....	26
Replaced Figure 45.....	26
Change to Figure 47	27
Change to Figure 48.....	27
Change to Figure 51	29
Change to Figure 52.....	29
Change to Figure 53.....	30
Change to DATAADJUST Synchronization Section.....	31
Changes to Power Dissipation Section.....	40
Changes to Table 37	42
Changes to Data Inputs Section	46
Change to Figure 88.....	49
Replaced Figure 95.....	55
Updated Outline Dimensions.....	60
Changes to Ordering Guide.....	60

7/04—Revision 0: Initial Version

GENERAL DESCRIPTION

The AD9786 is a 16-bit, high speed, CMOS DAC with 2×/4×/8× interpolation and signal processing features tuned for communications applications. It offers state-of-the-art distortion and noise performance. The AD9786 was developed to meet the demanding performance requirements of multicarrier and third-generation base stations. The selectable interpolation filters simplify interfacing to a variety of input data rates while also taking advantage of oversampling performance gains. The modulation modes allow convenient bandwidth placement and selectable sideband suppression.

The flexible clock interface accepts a variety of input types such as 1 V p-p sine wave, CMOS, and LVPECL in single-ended or differential mode. Internal dividers generate the required data rate interface clocks.

The AD9786 provides a differential current output, supporting single-ended or differential applications; it provides a nominal full-scale current from 10 mA to 20 mA. The AD9786 is manufactured on an advanced, low cost, 0.25 μm CMOS process.

SPECIFICATIONS

DC SPECIFICATIONS

T_{MIN} to T_{MAX} ; AVDD1, AVDD2, DRVDD = 3.3 V; ACVDD, ADVDD, CLKVDD, DVDD = 2.5 V; I_{OUTFS} = 20 mA, unless otherwise noted.

Table 1.

Parameter	Min	Typ	Max	Unit
RESOLUTION		16		Bits
DC Accuracy ¹				
Integral Nonlinearity		±0.6		LSB
Differential Nonlinearity		±0.3		LSB
ANALOG OUTPUT				
Offset Error		±0.015	±0.0175	% of FSR
Gain Error (with Internal Reference)		±1.5		% of FSR
Full-Scale Output Current ²	10		20	mA
Output Compliance Range	-1.0		+1.0	V
Output Resistance		10		MΩ
REFERENCE OUTPUT				
Reference Voltage	1.15	1.23	1.30	V
Reference Output Current ³		1		μA
REFERENCE INPUT				
Input Compliance Range	0.1		1.25	V
Reference Input Resistance (External Reference Mode)		10		MΩ
Small Signal Bandwidth		200		kHz
TEMPERATURE COEFFICIENTS				
Unipolar Offset Drift		0		ppm of FSR/°C
Gain Drift (with Internal Reference)		±4		ppm of FSR/°C
Reference Voltage Drift		±30		ppm/°C
POWER SUPPLY				
AVDD1, AVDD2				
Voltage Range	3.1	3.3	3.5	V
Analog Supply Current ($I_{AVDD1} + I_{AVDD2}$)		50		mA
$I_{AVDD1} + I_{AVDD2}$ in Sleep Mode		18		mA
ACVDD, ADVDD				
Voltage Range	2.35	2.5	2.65	V
Analog Supply Current ($I_{ACVDD} + I_{ADVDD}$)		2.5		mA
CLKVDD				
Voltage Range	2.35	2.5	2.65	V
Clock Supply Current (I_{CLKVDD})		12		mA
DVDD				
Voltage Range	2.35	2.5	2.65	V
Digital Supply Current (I_{DVDD})		52.5		mA
DRVDD				
Voltage Range	3.1	3.3	3.5	V
Digital Supply Current (I_{DRVDD})		5.3		μA
Nominal Power Dissipation ⁴		1.25		W
OPERATING RANGE	-40		+85	°C

¹ Measured at I_{OUTA} driving a virtual ground.

² Nominal full-scale current, I_{OUTFS} , is 32× the I_{REF} current.

³ Use an external amplifier to drive any external load.

⁴ Measured under the following conditions: $f_{DATA} = 125$ MSPS, $f_{DAC} = 500$ MSPS, 4× interpolation, $f_{DAC}/4$ modulation, Hilbert off.

DYNAMIC SPECIFICATIONS

T_{MIN} to T_{MAX} ; AVDD1, AVDD2, DRVDD = 3.3 V; ACVDD, ADVDD, CLKVDD, DVDD = 2.5 V; I_{OUTFS} = 20 mA; differential transformer coupled output; 50 Ω doubly terminated, unless otherwise noted.

Table 2.

Parameter	Min	Typ	Max	Unit
DYNAMIC PERFORMANCE				
Minimum DAC Output Update Rate			20	MHz
Maximum DAC Output Update Rate (f_{DAC})	500			MSPS
AC LINEARITY/BASEBAND MODE				
Spurious-Free Dynamic Range (SFDR) to Nyquist ($f_{OUT} = 0$ dBFS)				
$f_{DATA} = 100$ MSPS; $f_{OUT} = 5$ MHz, 4 \times , 2 \times Interpolation		93		dBc
$f_{DATA} = 200$ MSPS; $f_{OUT} = 10$ MHz		85		dBc
$f_{DATA} = 200$ MSPS; $f_{OUT} = 25$ MHz		78		dBc
$f_{DATA} = 200$ MSPS; $f_{OUT} = 50$ MHz		78		dBc
Two-Tone Intermodulation (IMD) to Nyquist ($f_{OUT1} = f_{OUT2} = -6$ dBFS)				
$f_{DATA} = 200$ MSPS; $f_{OUT1} = 5$ MHz; $f_{OUT2} = 6$ MHz		85		dBc
$f_{DATA} = 200$ MSPS; $f_{OUT1} = 15$ MHz; $f_{OUT2} = 16$ MHz		85		dBc
$f_{DATA} = 200$ MSPS; $f_{OUT1} = 25$ MHz; $f_{OUT2} = 26$ MHz		84		dBc
$f_{DATA} = 200$ MSPS; $f_{OUT1} = 45$ MHz; $f_{OUT2} = 46$ MHz		80		dBc
$f_{DATA} = 200$ MSPS; $f_{OUT1} = 65$ MHz; $f_{OUT2} = 66$ MHz		78		dBc
$f_{DATA} = 200$ MSPS; $f_{OUT1} = 85$ MHz; $f_{OUT2} = 86$ MHz		75		dBc
Noise Power Spectral Density (NPSD)				
$f_{DATA} = 156$ MSPS; $f_{OUT} = 10$ MHz; 0 dBFS, 8 Tones, Separation = 500 kHz		-164		dBm/Hz
$f_{DATA} = 156$ MSPS; $f_{OUT} = 50$ MHz; 0 dBFS, 8 Tones, Separation = 500 kHz		-161		dBm/Hz
Adjacent Channel Power Ratio (ACLR)				
WCDMA ACLR with 3.84 MHz BW, Single Carrier				
IF = 21 MHz, $f_{DATA} = 122.88$ MSPS, 4 \times Interpolation		80		dB
IF = 224.76 MHz, $f_{DATA} = 122.88$ MSPS, 4 \times Interpolation, High-Pass Interpolation Filter Mode		72		dB

DIGITAL SPECIFICATIONS

T_{MIN} to T_{MAX} ; AVDD1, AVDD2, DRVDD = 3.3 V; ACVDD, ADVDD, CLKVDD, DVDD = 2.5 V; I_{OUTFS} = 20 mA, unless otherwise noted.

Table 3.

Parameter	Min	Typ	Max	Unit
DIGITAL INPUTS				
Logic 1 Voltage	1.6			V
Logic 0 Voltage		0	0.9	V
Logic 1 Current	-10		+10	μ A
Logic 0 Current	-10		+10	μ A
Input Capacitance		5		pF
CLOCK INPUTS¹				
Input Voltage Range	0		2.65	V
Common-Mode Voltage	0.75	1.5	2.25	V
Differential Voltage	0.5	1.5		V
Latch Pulse Width (t_{LPW})	5			ns
Data Setup Time to DACCLK Out in Master Mode (t_s)	-0.5			ns
Data Hold Time to DACCLK Out in Master Mode (t_H)	2.9			ns

¹ See the Clock/Data Timing section for setup and hold times in various timing modes.

ABSOLUTE MAXIMUM RATINGS

Table 4.

Parameter	With Respect to	Rating
AVDD1, AVDD2, DRVDD	AGND1, AGND2, ACGND, ADGND, CLKGND, DGND	-0.3 V to +3.6 V
ACVDD, ADVDD, CLKVDD, DVDD	AGND1, AGND2, ACGND, ADGND, CLKGND, DGND	-0.3 V to +2.8 V
AGND1, AGND2, ACGND, ADGND, CLKGND, DGND	AGND1, AGND2, ACGND, ADGND, CLKGND, DGND	-0.3 V to +0.3 V
REFIO, FSADJ	AGND1	-0.3 to AVDD1 + 0.3
IOUTA, IOUTB	AGND1	-1.0 to AVDD1 + 0.3
P1B15 to P1B0, P2B15 to P2B0, RESET	DGND	-0.3 to DRVDD + 0.3
DATACLK	DGND	-0.3 to DRVDD + 0.3
CLK+, CLK-	CLKGND	-0.3 to CLKVDD + 0.3
CSB, SCLK, SDIO, SDO	DGND	-0.3 to DRVDD + 0.3
Junction Temperature Range		-65°C to +125°C
Storage Temperature		150°C
Lead Temperature (10 sec)		300°C

Stresses above those listed under Absolute Maximum Ratings may cause permanent damage to the device. This is a stress rating only; functional operation of the device at these or any other conditions above those indicated in the operational section of this specification is not implied. Exposure to absolute maximum rating conditions for extended periods may affect device reliability.

THERMAL RESISTANCE

θ_{JA} is specified for the worst-case conditions, that is, a device soldered in a circuit board for surface-mount packages.

Table 5. Thermal Resistance

Package Type ¹	θ_{JA}	Unit
80-lead TQFP_EP (Thermally Enhanced)	23.5	°C/W

¹With thermal pad soldered to PCB.

ESD CAUTION

ESD (electrostatic discharge) sensitive device. Electrostatic charges as high as 4000 V readily accumulate on the human body and test equipment and can discharge without detection. Although this product features proprietary ESD protection circuitry, permanent damage may occur on devices subjected to high energy electrostatic discharges. Therefore, proper ESD precautions are recommended to avoid performance degradation or loss of functionality.



PIN CONFIGURATION AND FUNCTION DESCRIPTIONS

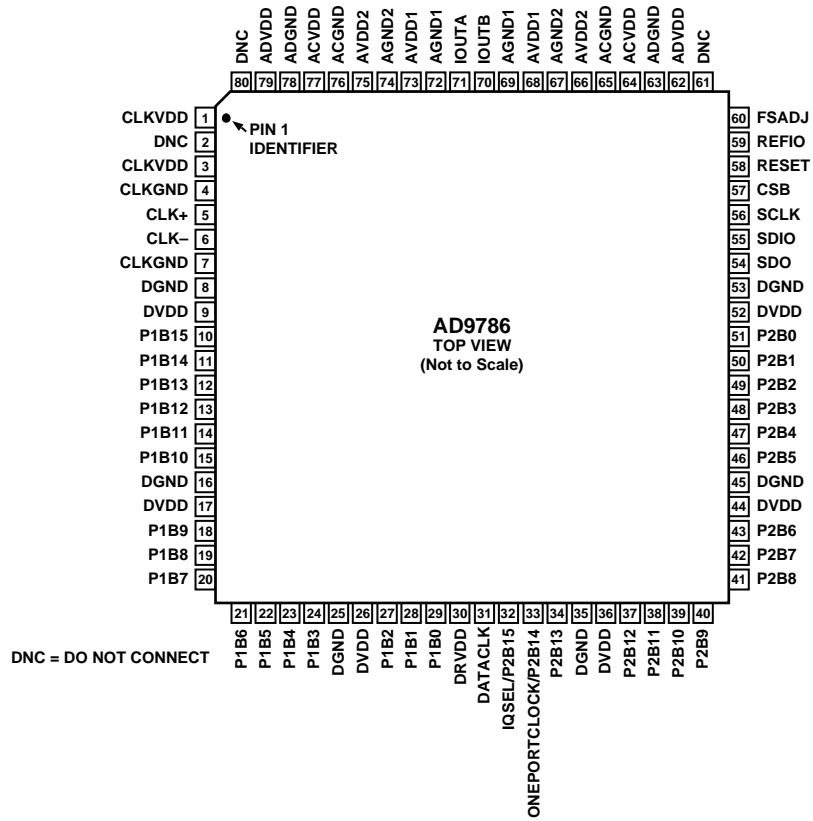

Figure 2. Pin Configuration

CLOCK

Table 6. Clock Pin Function Descriptions

Pin No.	Mnemonic	Direction	Description						
5, 6	CLK+, CLK-	I	Differential Clock Input.						
2	DNC		Do Not Connect.						
31	DATACLK	I/O	<table border="1" style="width: 100%; border-collapse: collapse;"> <thead> <tr> <th style="text-align: left;">DCLKEXT 0x02[3]</th> <th style="text-align: left;">Mode</th> </tr> </thead> <tbody> <tr> <td>0</td> <td>Pin configured for input of channel data rate or synchronizer clock. Internal clock synchronizer can be turned on or off with DCLKCRC (0x02[2]).</td> </tr> <tr> <td>1</td> <td>Pin configured for output of channel data rate or synchronizer clock.</td> </tr> </tbody> </table>	DCLKEXT 0x02[3]	Mode	0	Pin configured for input of channel data rate or synchronizer clock. Internal clock synchronizer can be turned on or off with DCLKCRC (0x02[2]).	1	Pin configured for output of channel data rate or synchronizer clock.
DCLKEXT 0x02[3]	Mode								
0	Pin configured for input of channel data rate or synchronizer clock. Internal clock synchronizer can be turned on or off with DCLKCRC (0x02[2]).								
1	Pin configured for output of channel data rate or synchronizer clock.								
1, 3	CLKVDD		Clock Domain 2.5 V.						
4, 7	CLKGND		Clock Domain 0 V.						

AD9786

ANALOG

Table 7. Analog Pin Function Descriptions

Pin No.	Mnemonic	Direction	Description
59	REFIO	A	Reference.
60	FSADJ	A	Full-Scale Adjust.
70, 71	IOUTB, IOUTA	A	Differential DAC Output Currents.
61	DNC		Do Not Connect.
62, 79	ADVDD		Analog Domain Digital Content 2.5 V.
63, 78	ADGND		Analog Domain Digital Content 0 V.
64, 77	ACVDD		Analog Domain Clock Content 2.5 V.
65, 76	ACGND		Analog Domain Clock Content 0 V.
66, 75	AVDD2		Analog Domain Clock Switching 3.3 V.
67, 74	AGND2		Analog Domain Switching 0 V.
68, 73	AVDD1		Analog Domain Quiet 3.3 V.
69, 72	AGND1		Analog Domain Quiet 0 V.
80	DNC		Do Not Connect.

DATA

Table 8. Data Pin Function Descriptions

Pin No.	Mnemonic	Direction	Description																								
10 to 15, 18 to 24, 27 to 29	P1B15 to P1B0	I	Input Data Port 1.																								
			<table border="1"> <thead> <tr> <th>ONEPORT 0x02[6]</th> <th>Mode</th> </tr> </thead> <tbody> <tr> <td>0</td> <td>Latched data routed for I channel processing.</td> </tr> <tr> <td>1</td> <td>Latched data demultiplexed by IQSEL and routed for interleaved I/Q processing.</td> </tr> </tbody> </table>	ONEPORT 0x02[6]	Mode	0	Latched data routed for I channel processing.	1	Latched data demultiplexed by IQSEL and routed for interleaved I/Q processing.																		
ONEPORT 0x02[6]	Mode																										
0	Latched data routed for I channel processing.																										
1	Latched data demultiplexed by IQSEL and routed for interleaved I/Q processing.																										
32	IQSEL/P2B15	I	<table border="1"> <thead> <tr> <th>ONEPORT 0x02[6]</th> <th>IQPOL 0x02[1]</th> <th>IQSEL/P2B15</th> <th>Mode (IQPOL = 0)</th> </tr> </thead> <tbody> <tr> <td>0</td> <td>X</td> <td>X</td> <td>Latched data routed to Q channel Bit 15 (MSB) processing.</td> </tr> <tr> <td>1</td> <td>0</td> <td>0</td> <td>Latched data on Data Port 1 routed to Q channel processing.</td> </tr> <tr> <td>1</td> <td>0</td> <td>1</td> <td>Latched data on Data Port 1 routed to I channel processing.</td> </tr> <tr> <td>1</td> <td>1</td> <td>0</td> <td>Latched data on Data Port 1 routed to I channel processing.</td> </tr> <tr> <td>1</td> <td>1</td> <td>1</td> <td>Latched data on Data Port 1 routed to Q channel processing.</td> </tr> </tbody> </table>	ONEPORT 0x02[6]	IQPOL 0x02[1]	IQSEL/P2B15	Mode (IQPOL = 0)	0	X	X	Latched data routed to Q channel Bit 15 (MSB) processing.	1	0	0	Latched data on Data Port 1 routed to Q channel processing.	1	0	1	Latched data on Data Port 1 routed to I channel processing.	1	1	0	Latched data on Data Port 1 routed to I channel processing.	1	1	1	Latched data on Data Port 1 routed to Q channel processing.
			ONEPORT 0x02[6]	IQPOL 0x02[1]	IQSEL/P2B15	Mode (IQPOL = 0)																					
			0	X	X	Latched data routed to Q channel Bit 15 (MSB) processing.																					
			1	0	0	Latched data on Data Port 1 routed to Q channel processing.																					
			1	0	1	Latched data on Data Port 1 routed to I channel processing.																					
			1	1	0	Latched data on Data Port 1 routed to I channel processing.																					
1	1	1	Latched data on Data Port 1 routed to Q channel processing.																								
33	ONEPORTCLOCK/P2B14	I/O	<table border="1"> <thead> <tr> <th>ONEPORT 0x02[6]</th> <th></th> </tr> </thead> <tbody> <tr> <td>0</td> <td>Latched data routed for Q channel Bit 14 processing.</td> </tr> <tr> <td>1</td> <td>Pin configured for output of clock at twice the channel data rate.</td> </tr> </tbody> </table>	ONEPORT 0x02[6]		0	Latched data routed for Q channel Bit 14 processing.	1	Pin configured for output of clock at twice the channel data rate.																		
			ONEPORT 0x02[6]																								
0	Latched data routed for Q channel Bit 14 processing.																										
1	Pin configured for output of clock at twice the channel data rate.																										
34, 37 to 43, 46 to 51	P2B13 to P2B0	I	Input Data Port 2, Bit 13 to Bit 0.																								
30	DRVDD		Digital Output Pin Supply, 3.3 V.																								
9, 17, 26, 36, 44, 52	DVDD		Digital Domain, 2.5 V.																								
8, 16, 25, 35, 45, 53	DGND		Digital Domain, 0 V.																								

SERIAL INTERFACE

Table 9. Serial Interface Pin Function Descriptions

Pin No.	Mnemonic	Direction	Description		
54	SDO	O		SDIODIR	
			CSB	0x00[7]	Mode
			1	X	High impedance.
			0	0	Serial data output.
55	SDIO	I/O	0	1	High impedance.
				SDIODIR	
			CSB	0x00[7]	Mode
			1	X	High impedance.
56	SCLK	I	0	0	Serial data output.
			0	1	Serial data input/output depending on Bit 7 of the serial instruction byte.
			0	1	Serial data input/output depending on Bit 7 of the serial instruction byte.
57	CSB	I	Serial Interface Chip Select.		
58	RESET	I	Resets entire chip to default state.		

TERMINOLOGY

Linearity Error (Integral Nonlinearity or INL)

Linearity error is defined as the maximum deviation of the actual analog output from the ideal output, determined by a straight line drawn from zero to full scale.

Differential Nonlinearity (DNL)

DNL is the measure of the variation in analog value, normalized to full scale, associated with a 1 LSB change in digital input code.

Monotonicity

A D/A converter is monotonic if the output either increases or remains constant as the digital input increases.

Offset Error

The deviation of the output current from the ideal of zero is called offset error. For I_{OUTA} , 0 mA output is expected when the inputs are all 0s. For I_{OUTB} , 0 mA output is expected when all inputs are set to 1.

Gain Error

The difference between the actual and ideal output span. The actual span is determined by the output when all inputs are set to 1, minus the output when all inputs are set to 0.

Output Compliance Range

The range of allowable voltage at the output of a current-output DAC. Operation beyond the maximum compliance limits can cause either output stage saturation or breakdown, resulting in nonlinear performance.

Temperature Drift

Temperature drift is specified as the maximum change from the ambient (+25°C) value to the value at either T_{MIN} or T_{MAX} . For offset and gain drift, the drift is reported in ppm of full-scale range (FSR) per degree Celsius. For reference drift, the drift is reported in ppm per degree Celsius.

Power Supply Rejection

The maximum change in the full-scale output as the supplies are varied from minimum to maximum specified voltages.

Settling Time

The time required for the output to reach and remain within a specified error band about its final value, measured from the start of the output transition.

Glitch Impulse

Asymmetrical switching times in a DAC give rise to undesired output transients that are quantified by a glitch impulse. It is specified as the net area of the glitch in pV-sec.

Spurious-Free Dynamic Range (SFDR)

The difference between the rms amplitude of the output signal and the amplitude of the peak spurious signal over the specified bandwidth. The units are often in dBc (dB with respect to the carrier).

Total Harmonic Distortion (THD)

THD is the ratio of the rms sum of the first six harmonic components to the rms value of the measured fundamental. It is expressed as a percentage or in decibels.

Signal-to-Noise Ratio (SNR)

SNR is the ratio of the rms value of the measured output signal to the rms sum of all other spectral components below the Nyquist frequency, excluding the first six harmonics and dc. The value for SNR is expressed in decibels.

Interpolation Filter

If the digital inputs to the DAC are sampled at a multiple rate of f_{DATA} (interpolation rate), a digital filter can be constructed that has a sharp transition band near $f_{DATA}/2$. Images that would typically appear around f_{DAC} (output data rate) can be greatly suppressed.

Pass Band

Frequency band in which any input applied therein passes unattenuated to the DAC output.

Stop-Band Rejection

The amount of attenuation of a frequency outside the pass band applied to the DAC, relative to a full-scale signal applied at the DAC input within the pass band.

Group Delay

Number of input clocks between an impulse applied at the device input and peak DAC output current. A half-band FIR filter has constant group delay over its entire frequency range

Impulse Response

Response of the device to an impulse applied to the input.

Adjacent Channel Leakage Ratio (ACLR)

A ratio in dBc between the measured power within a channel relative to its adjacent channel.

Complex Modulation

The process of passing the real and imaginary components of a signal through a complex modulator (transfer function = $e^{j\omega t} = \cos\omega t + j\sin\omega t$) and realizing real and imaginary components on the modulator output.

Hilbert Transform

A function with unity gain over all frequencies, but with a phase shift of 90° for negative frequencies and a phase shift of -90° for positive frequencies. Although this function cannot be implemented ideally, it can be approximated with a short FIR filter with enough accuracy to be very useful in single sideband radio architectures.

Complex Image Rejection

In a traditional two-part upconversion, two images are created around the second IF frequency. These images are redundant and have the effect of wasting transmitter power and system bandwidth. By placing the real part of a second complex modulator in series with the first complex modulator, either the upper or lower frequency image near the second IF can be rejected.

TYPICAL PERFORMANCE CHARACTERISTICS

T_{MIN} to T_{MAX}; AVDD1, AVDD2, DRVDD = 3.3 V; ACVDD, ADVDD, CLKVDD, DVDD = 2.5 V; I_{OUTFS} = 20 mA; differential transformer coupled output; 50 Ω doubly terminated, unless otherwise noted.

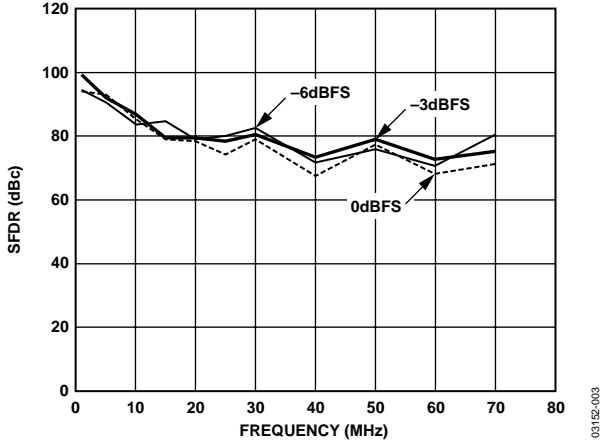

03152-003

Figure 3. SFDR vs. Frequency, $f_{DATA} = 200$ MSPS, 1× Interpolation

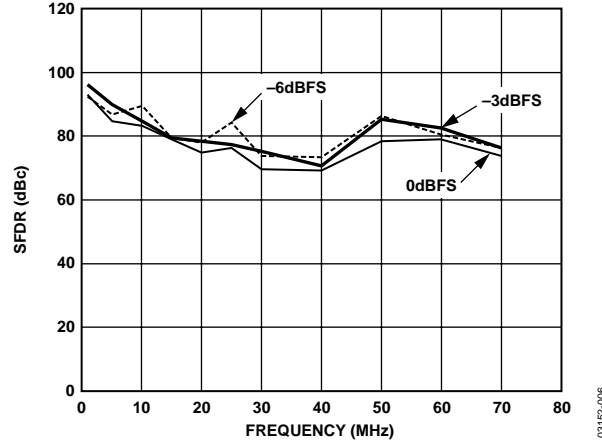

03152-006

Figure 6. SFDR vs. Frequency, $f_{DATA} = 200$ MSPS, 2× Interpolation

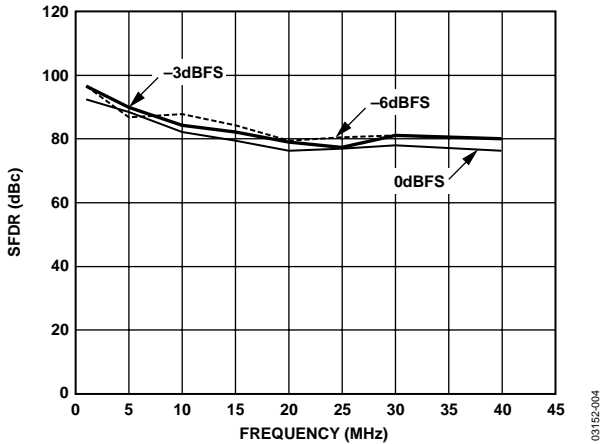

03152-004

Figure 4. SFDR vs. Frequency, $f_{DATA} = 100$ MSPS, 4× Interpolation

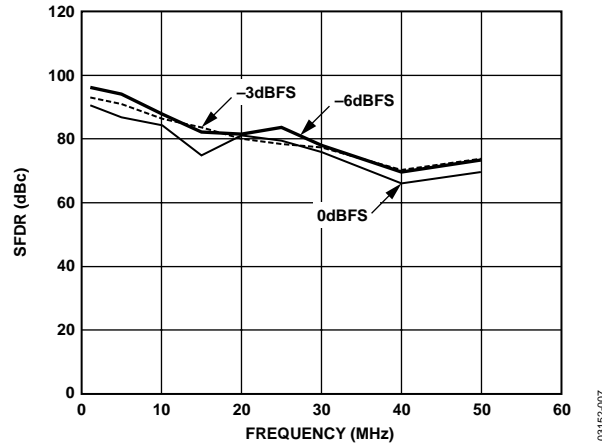

03152-007

Figure 7. SFDR vs. Frequency, $f_{DATA} = 125$ MSPS, 4× Interpolation

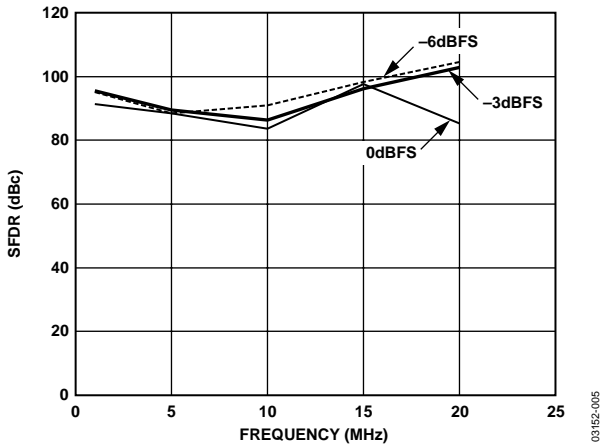

03152-005

Figure 5. SFDR vs. Frequency, $f_{DATA} = 50$ MSPS, 8× Interpolation

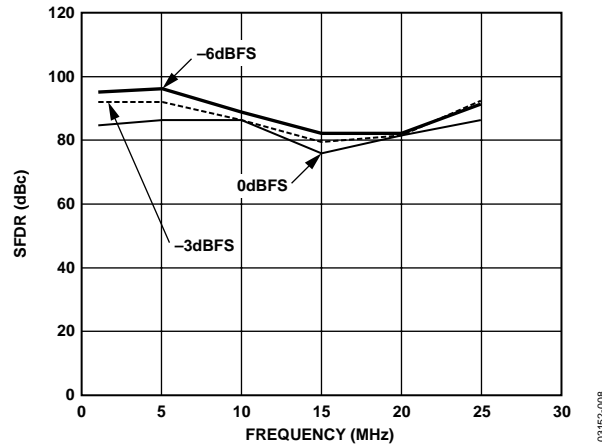

03152-008

Figure 8. SFDR vs. Frequency, $f_{DATA} = 62.5$ MSPS, 8× Interpolation

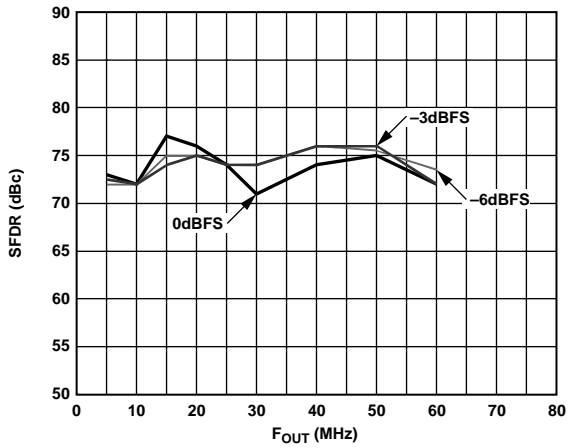

03152-009

Figure 9. Out-of-Band SFDR, $f_{DATA} = 200$ MSPS, $2\times$ Interpolation

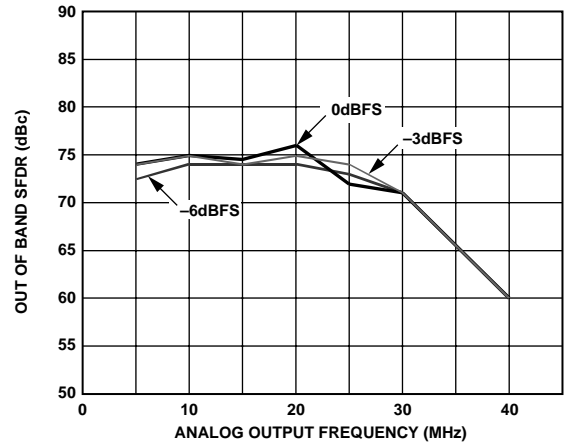

03152-012

Figure 12. Out-of-Band SFDR, $f_{DATA} = 100$ MSPS, $4\times$ Interpolation

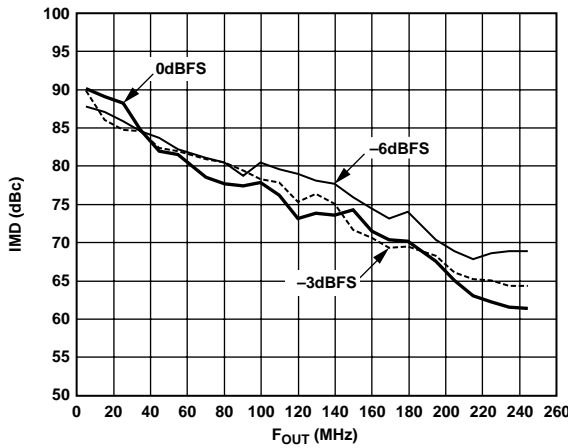

03152-010

Figure 10. Out-of-Band SFDR, $f_{DATA} = 125$ MSPS, $4\times$ Interpolation

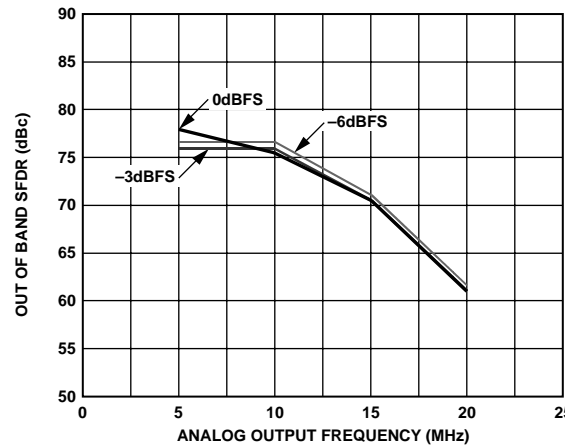

03152-013

Figure 13. Out-of-Band SFDR, $f_{DATA} = 50$ MSPS, $8\times$ Interpolation

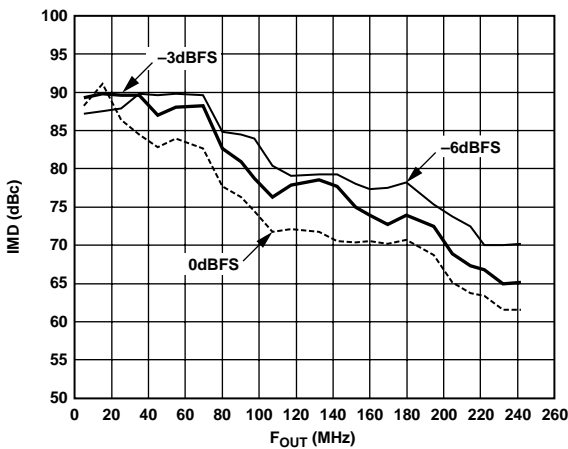

03152-011

Figure 11. Out-of-Band SFDR, $f_{DATA} = 62.5$ MSPS, $8\times$ Interpolation

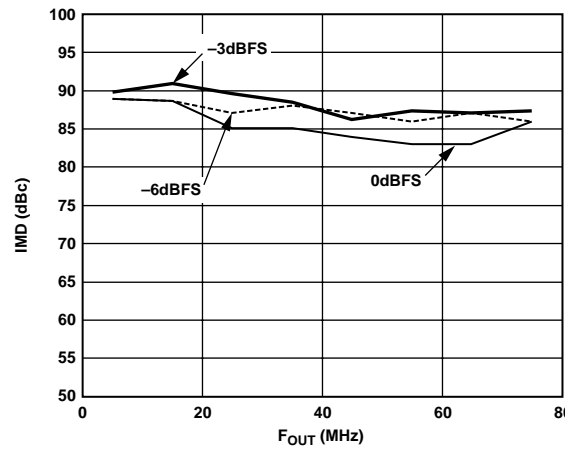

03152-014

Figure 14. Third-Order IMD vs. Frequency, $f_{DATA} = 160$ MSPS, $1\times$ Interpolation

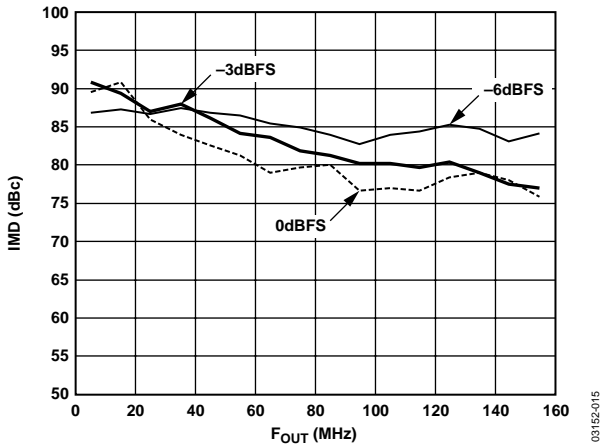

Figure 15. Third-Order IMD vs. Frequency, $f_{DATA} = 160$ MSPS, 2x Interpolation

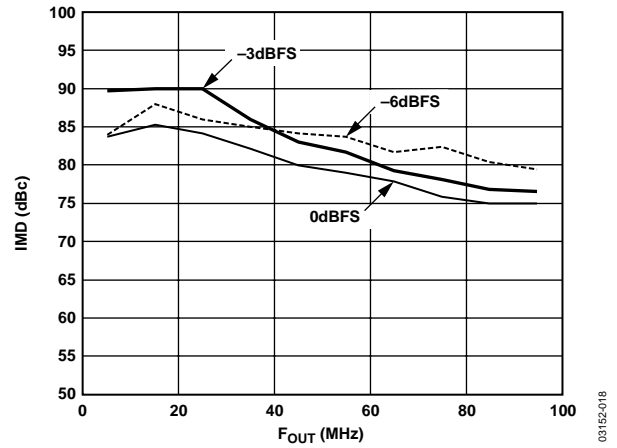

Figure 18. Third-Order IMD vs. Frequency, $f_{DATA} = 200$ MSPS, 1x Interpolation

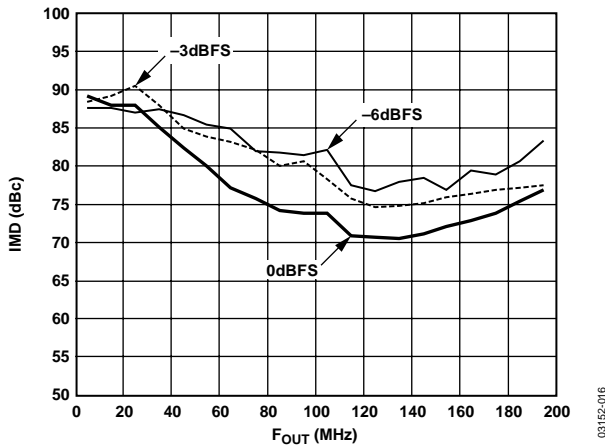

Figure 16. Third-Order IMD vs. Frequency, $f_{DATA} = 200$ MSPS, 2x Interpolation

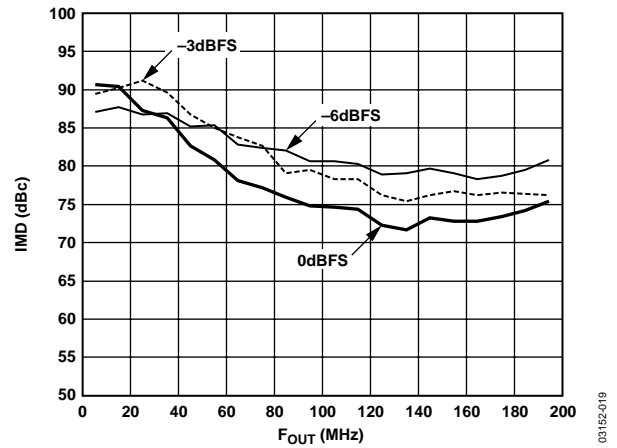

Figure 19. Third-Order IMD vs. Frequency, $f_{DATA} = 100$ MSPS, 4x Interpolation

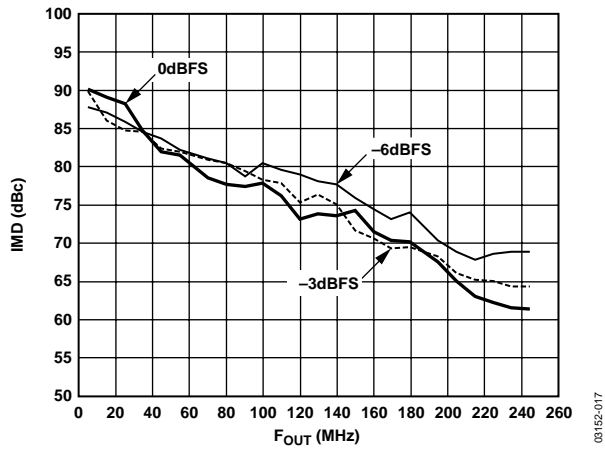

Figure 17. Third-Order IMD vs. Frequency, $f_{DATA} = 125$ MSPS, 4x Interpolation

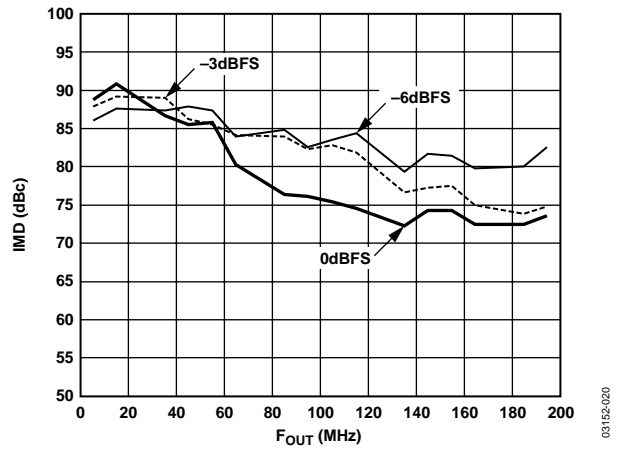

Figure 20. Third-Order IMD vs. Frequency, $f_{DATA} = 50$ MSPS, 8x Interpolation

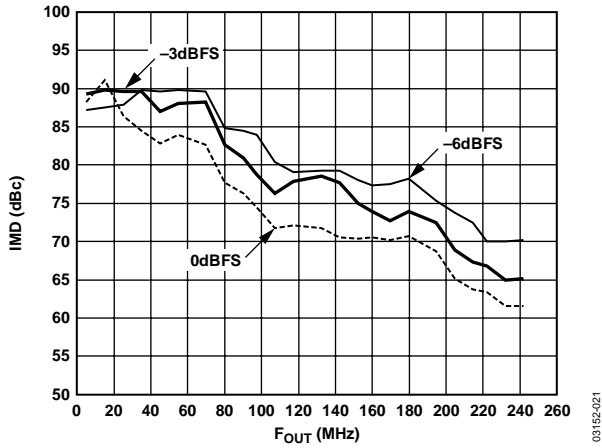

Figure 21. Third-Order IMD vs. Frequency, $f_{DATA} = 62.5$ MSPS, 8x Interpolation

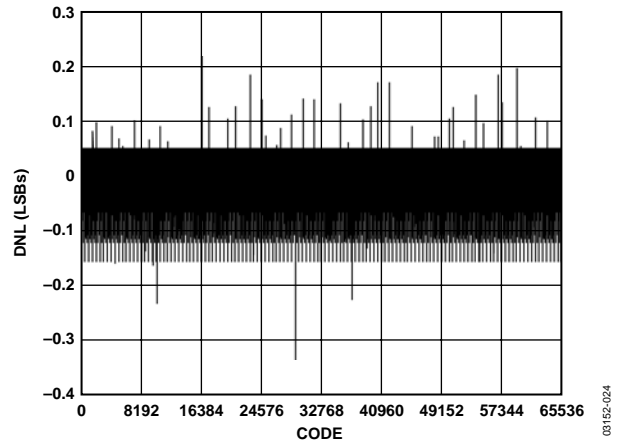

Figure 24. Typical DNL

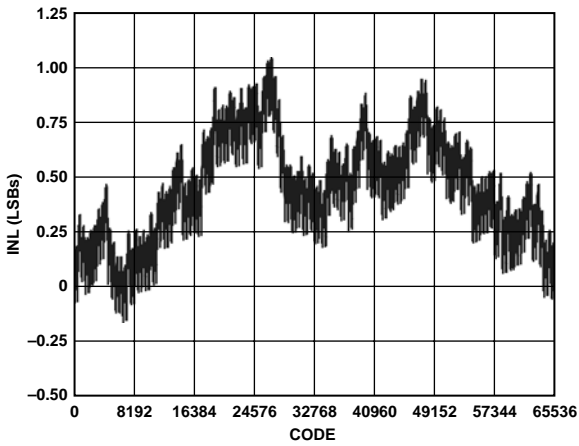

Figure 22. Typical INL

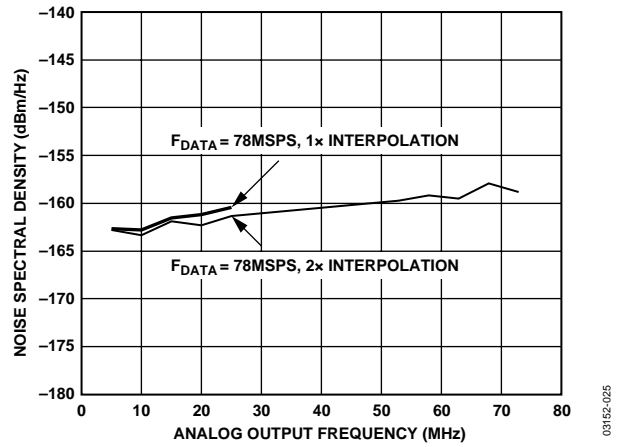

Figure 25. Noise Spectral Density vs. Analog Input Frequency, $f_{DATA} = 78$ MSPS

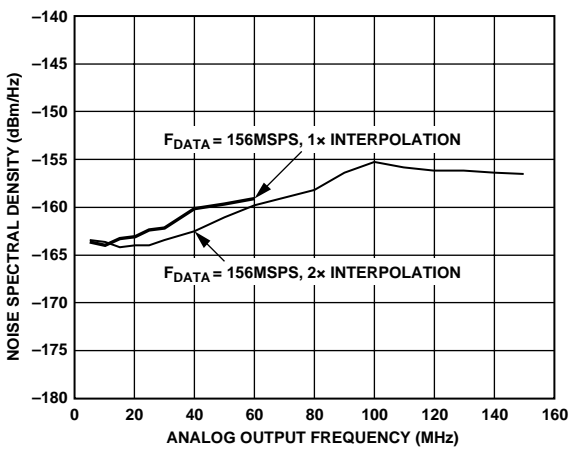

Figure 23. Noise Spectral Density vs. Analog Input Frequency, $f_{DATA} = 156$ MSPS

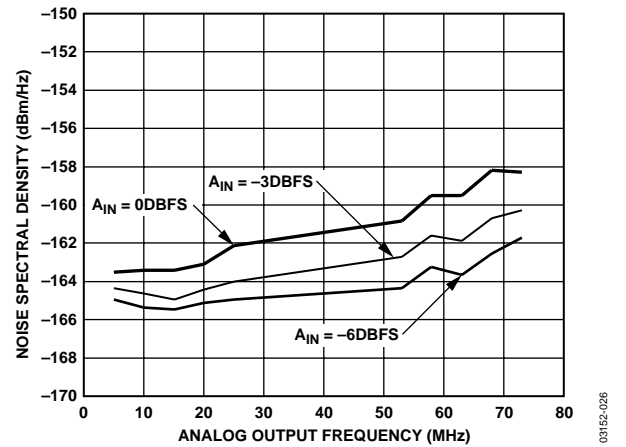

Figure 26. Noise Spectral Density vs. Analog Input Frequency, $f_{DATA} = 78$ MSPS, 2x Interpolation

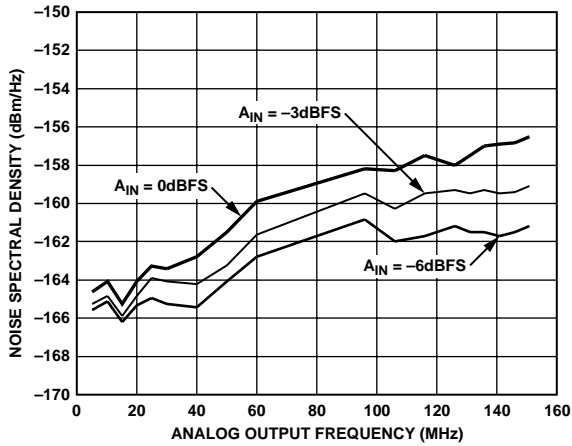

Figure 27. Noise Spectral Density vs. Analog Input Frequency, $f_{DATA} = 156$ MSPS, 2x Interpolation

03152-027

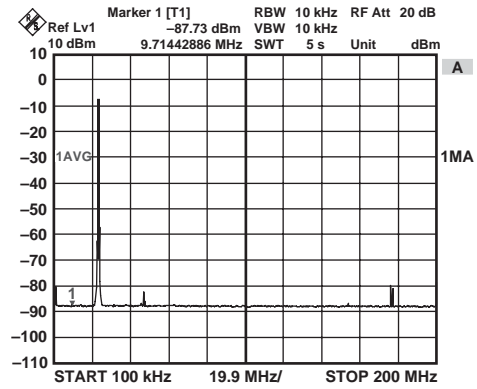

Figure 30. Two Tones Around 23 MHz, $f_{DATA} = 200$ MSPS, 2x Interpolation, Low-Pass Digital Filter Mode

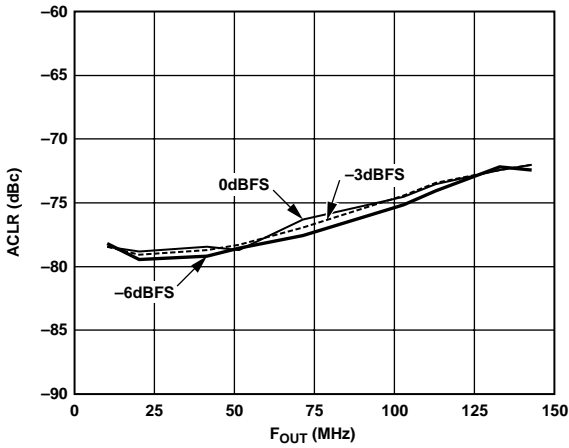

Figure 28. ACLR for First Adjacent Band vs. Frequency, $f_{DATA} = 61.44$ MSPS, 4x Interpolation

03152-028

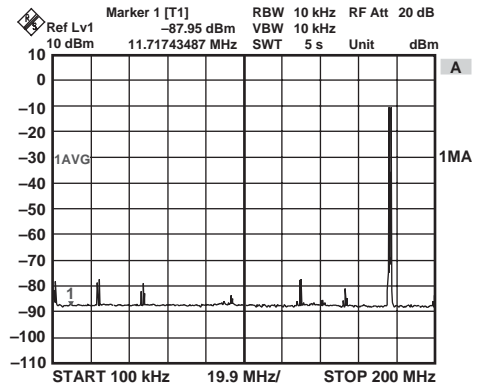

Figure 31. Two Tones Around 177 MHz, $f_{DATA} = 200$ MSPS, 2x Interpolation, High-Pass Digital Filter Mode

03152-031

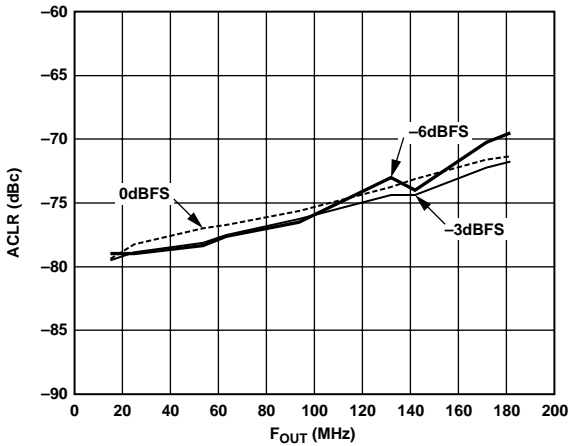

Figure 29. ACLR for First Adjacent Band vs. Frequency, $f_{DATA} = 76.8$ MSPS, 4x Interpolation

03152-028

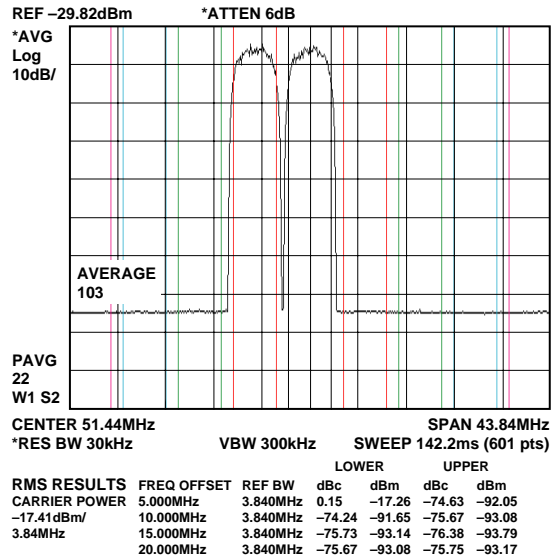

Figure 32. ACLR for Two WCDMA Carriers @ 51.44 MHz, $f_{DATA} = 61.44$ MSPS, 4x Interpolation

03152-032

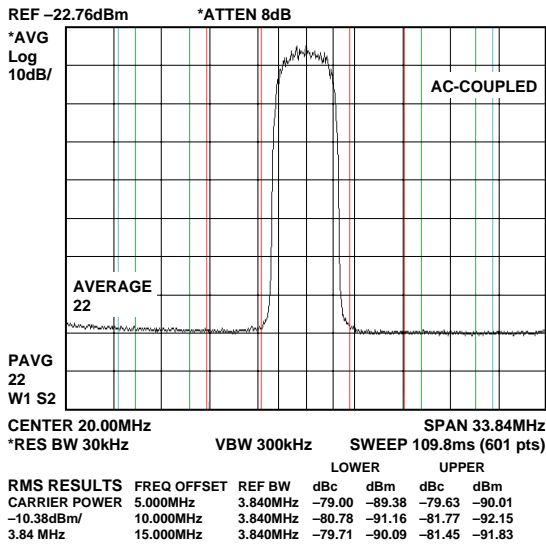

Figure 33. ACLR for Single WCDMA Carrier @ 20 MHz, $f_{DATA} = 61.44$ MSPS, 4x Interpolation

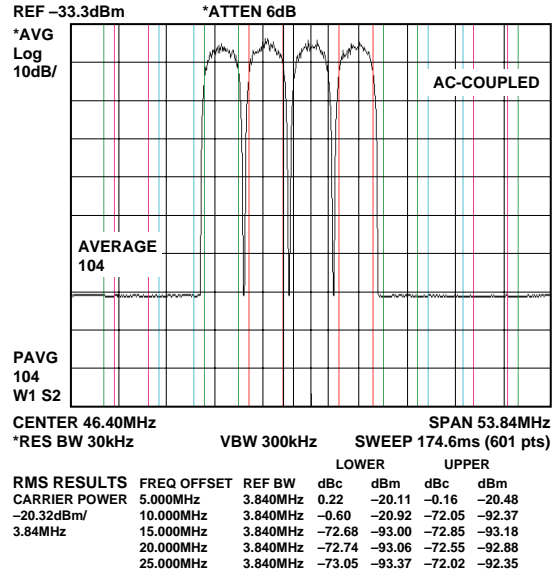

Figure 35. ACLR for Four WCDMA Carriers Near 50 MHz, $f_{DATA} = 61.44$ MSPS, 4x Interpolation

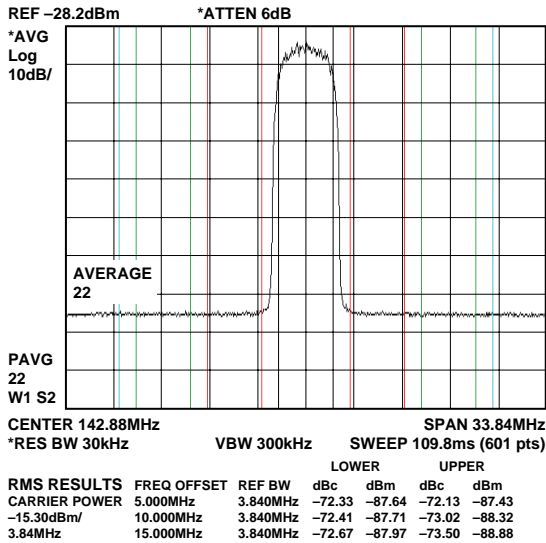

Figure 34. ACLR for Single WCDMA Carrier @ 142.88 MHz, $f_{DATA} = 61.44$ MSPS, 4x Interpolation

SERIAL CONTROL INTERFACE

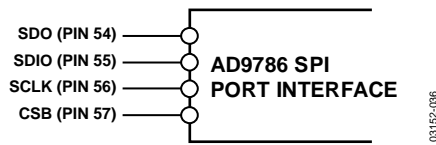

Figure 36. AD9786 SPI Port Interface

The AD9786 serial port is a flexible, synchronous serial communications port, allowing easy interface to many industry-standard microcontrollers and microprocessors. The serial I/O is compatible with most synchronous transfer formats, including both the Motorola SPI® and Intel® SSR protocols. The interface allows read/write access to all registers that configure the AD9786. Single- or multiple-byte transfers are supported, as well as MSB-first or LSB-first transfer formats. The AD9786 serial interface port can be configured as a single pin I/O (SDIO), or as two unidirectional pins for input/output (SDIO/SDO).

GENERAL OPERATION OF THE SERIAL INTERFACE

There are two phases to a communication cycle with the AD9786. Phase 1 is the instruction cycle, which is the writing of an instruction byte into the AD9786, coincident with the first eight SCLK rising edges. The instruction byte provides the AD9786 serial port controller with information regarding the data transfer cycle, which is Phase 2 of the communication cycle. The Phase 1 instruction byte defines whether the upcoming data transfer is a read or a write, the number of bytes in the data transfer, and the starting register address for the first byte of the data transfer. The first eight SCLK rising edges of each communication cycle are used to write the instruction byte into the AD9786.

A logic high on the CSB pin, followed by a logic low, resets the SPI port timing to the initial state of the instruction cycle. This is true regardless of the present state of the internal registers or the other signal levels present at the inputs to the SPI port. If the SPI port is in the midst of an instruction cycle or a data transfer cycle, none of the present data is written.

The remaining SCLK edges are for Phase 2 of the communication cycle. Phase 2 is the actual data transfer between the AD9786 and the system controller. Phase 2 of the communication cycle is a transfer of 1, 2, 3, or 4 data bytes, as determined by the instruction byte. Using one multibyte transfer is the preferred method. Single-byte data transfers are useful to reduce CPU overhead when register access requires one byte only. Registers change immediately upon writing to the last bit of each transfer byte.

Instruction Byte

R/ \overline{W} , Bit 7 of the instruction byte, determines whether a read or a write data transfer occurs after the instruction byte write. Logic high indicates a read operation; Logic 0 indicates a write operation. N1 and N0, Bit 6 and Bit 5 of the instruction byte, determine the number of bytes to be transferred during the data transfer cycle (see Table 10).

Table 10. Bytes Transferred During Data Transfer Cycle

N1	N2	Description
0	0	Transfer 1 byte
0	1	Transfer 2 bytes
1	0	Transfer 3 bytes
1	1	Transfer 4 bytes

The bit decodes are shown as follows:

MSB						LSB	
I7	I6	I5	I4	I3	I2	I1	I0
R/ \overline{W}	N1	N0	A4	A3	A2	A1	A0

A4, A3, A2, A1, and A0 (Bit 4, Bit 3, Bit 2, Bit 1, and Bit 0) of the instruction byte determine which register is accessed during the data transfer portion of the communication cycle. For multibyte transfers, this address is the starting byte address. The remaining register addresses are generated by the AD9786.

SERIAL INTERFACE PORT PIN DESCRIPTIONS

SCLK—Serial Clock. The serial clock pin is used to synchronize data to and from the AD9786 and to run the internal state machines. The maximum frequency of SCLK is 20 MHz. All data input to the AD9786 is registered on the rising edge of SCLK. All data is driven out of the AD9786 on the falling edge of SCLK.

CSB—Chip Select. Active low input starts and gates a communication cycle. It allows more than one device to be used on the same serial communication lines. The SDO and SDIO pins go to a high impedance state when this input is high. Chip select should stay low during the entire communication cycle.

SDIO—Serial Data I/O. Data is always written into the AD9786 on this pin. However, this pin can be used as a bidirectional data line. The configuration of this pin is controlled by Bit 7 of Register Address 0x00. The default is Logic 0, which configures the SDIO pin as unidirectional.

SDO—Serial Data Out. Data is read from this pin for protocols that use separate lines for transmitting and receiving data. In the case where the AD9786 operates in a single bidirectional I/O mode, this pin does not output data and is set to a high impedance state.

MSB/LSB TRANSFERS

The AD9786 serial port can support both MSB-first or LSB-first data formats. This functionality is controlled by register address DATADIR (0x00[6]). The default is MSB first. When this bit is set active high, the AD9786 serial port is in LSB-first format.

That is, if the AD9786 is in LSB-first mode, the instruction byte must be written from least significant bit to most significant bit. Multibyte data transfers in MSB-first format can be completed by writing an instruction byte that includes the register address of the most significant byte. In MSB-first mode, the serial port internal byte address generator decrements for each byte required of the multibyte communication cycle. Multibyte data transfers in LSB-first format can be completed by writing an instruction byte that includes the register address of the least significant byte. In LSB-first mode, the serial port internal byte address generator increments for each byte required of the multibyte communication cycle.

The AD9786 serial port controller address increments from 0x1F to 0x00 for multibyte I/O operations if the MSB-first mode is active. The serial port controller address decrements from 0x00 to 0x1F for multibyte I/O operations if the LSB-first mode is active.

NOTES ON SERIAL PORT OPERATION

The AD9786 serial port configuration bits reside in Bit 6 and Bit 7 of Register Address 0x00. Note that the configuration changes immediately upon writing to the last bit of the register. For multibyte transfers, writing to this register might occur during the middle of a communication cycle. Care must be taken to compensate for this new configuration for the remaining bytes of the current communication cycle.

The same considerations apply to setting the software reset SWRST (0x00[5]) bit. All other registers are set to their default values, but the software reset does not affect the bits in Register Address 0x00 and Register Address 0x04.

It is recommended to use only single-byte transfers when changing serial port configurations or initiating a software reset.

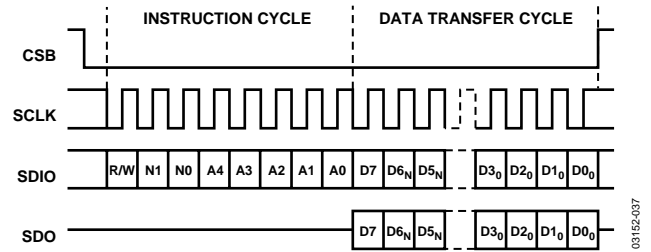

Figure 37. Serial Register Interface Timing MSB First

03152-037

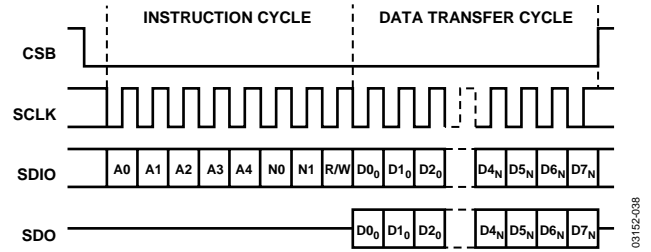

Figure 38. Serial Register Interface Timing LSB First

03152-038

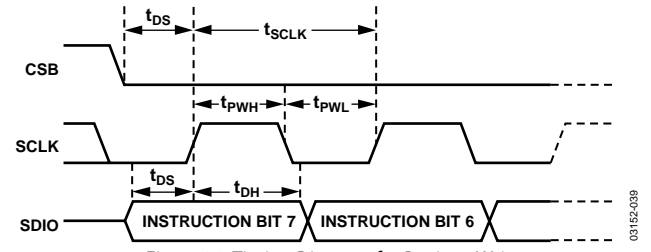

Figure 39. Timing Diagram for Register Write

03152-039

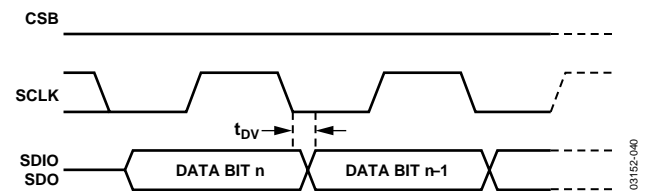

Figure 40. Timing Diagram for Register Read

03152-040

MODE CONTROL (VIA SERIAL PORT)

Table 11.

Address		Bit 7	Bit 6	Bit 5	Bit 4	Bit 3	Bit 2	Bit 1	Bit 0
COMMS	00	SDIODIR	DATADIR	SWRST	SLEEP	PDN			EXREF
FILTER	01	INTERP[1]	INTERP[0]			ZSTUFF	HPFX8	HPFX4	HPFX2
DATA	02	DATAFMT	ONEPORT	DCLKSTR	DCLKPOL	DCLKEXT	DCLKCRC	IQPOL	CRAYDIN
MODULATE	03	CHANNEL	HILBERT	MODDUAL	SIDEBAND	MOD[1]	MOD[0]		
RESERVED	04	Reserved	Reserved	Reserved	Reserved	Reserved	Reserved	Reserved	Reserved
DCLKCRC	05	DATAADJ[3]	DATAADJ[2]	DATAADJ[1]	DATAADJ[0]	MODSYNC	MODADJ[2]	MODADJ[1]	MODADJ[0]
	06	Reserved							
	07	Reserved							
	08	Reserved							
	09	Reserved							
	0A	Reserved							
	0B	Reserved							
	0C	Reserved							
	0D	Reserved							
CALMEMCK	0E			CALMEM[1]	CALMEN[0]		CALCKDIV[2]	CALCKDIV[2]	CALCKDIV[2]
MEMRDWR	0F	CALSTAT	CALEN	XFERSTAT	XFEREN	SMEMWR	SMEMRD	FMEMRD	UNCAL
MEMADDR	10	MEMADDR[7]	MEMADDR[6]	MEMADDR[5]	MEMADDR[4]	MEMADDR[3]	MEMADDR[2]	MEMADDR[1]	MEMADDR[0]
MEMDATA	11			MEMDATA[5]	MEMDATA[4]	MEMDATA[3]	MEMDATA[2]	MEMDATA[1]	MEMDATA[0]
DCRCSTAT	12						DCRCSTAT[2]	DCRCSTAT[1]	DCRCSTAT[0]

Table 12.

COMMS(00)	Bit	Direction	Default	Description
SDIODIR	7	I	0	0: SDIO pin configured for input only during data transfer 1: SDIO configured for input or output during data transfer
DATADIR	6	I	0	0: Serial data uses MSB-first format 1: Serial data uses LSB-first format
SWRST	5	I	0	1: Default all serial register bits, except Address 0x00 and Address 0x04
SLEEP	4	I	0	1: DAC output current off
PDN	3	I	0	1: All analog and digital circuitry, except serial interface, off
EXREF	0	I	0	0: Internal band gap reference 1: External reference

Table 13.

FILTER(01)	Bit	Direction	Default	Description
INTERP[1:0]	[7:6]	I	00	00: No interpolation 01: Interpolation 2× 10: Interpolation 4× 11: Interpolation 8×
ZSTUFF	3	I	0	1: Zero stuffing on
HPFX8	2	I	0	0: ×8 interpolation filter configured for low-pass 1: ×8 interpolation filter configured for high-pass
HPFX4	1	I	0	0: ×4 interpolation filter configured for low-pass 1: ×4 interpolation filter configured for high-pass
HPFX2	0	I	0	0: ×2 interpolation filter configured for low-pass 1: ×2 interpolation filter configured for high-pass

Table 14.

DATA(02)	Bit	Direction	Default	Description
DATAFMT	7	I	0	0: Twos complement data format 1: Unsigned binary input data format
ONEPORT	6	I	0	0: I and Q input data onto Port 1 and Port 2, respectively 1: I and Q input data interleaved onto Port 1
DCLKSTR	5	I	0	0: DATACLK pin, 12 mA drive strength 1: DATACLK pin, 24 mA drive strength
DCLKPOL	4	I	0	0: Input data latched on DATACLK/DACCLK rising edge (dependent on mode) 1: Input data latched on DATACLK/DACCLK falling edge (dependent on mode)
DCLKEXT	3	I	0	0: DATACLK pin inputs channel data rate or modulator synchronizer clock 1: DATACLK pin outputs channel data rate or modulator synchronizer clock
DCLKCRC	2	I	0	0: With DATACLK pin as input, DATACLK clock recovery off 1: With DATACLK pin as input, DATACLK clock recovery on
IQPOL	1	I	0	0: In one-port mode, IQSEL = 1 latches data into I channel, IQSEL = 0 latches data into Q channel 1: In one-port mode, IQSEL = 0 latches data into I channel, IQSEL = 1 latches data into Q channel
GRAYDIN	0	I	0	0: Gray decoder off 1: Gray decoder on

Table 15.

MODULATE(03)	Bit	Direction	Default	Description		
CHANNEL	7	I	0	MODDUAL 0x03[5]	CHANNEL 0x03[7]	
				0	0	I channel processing routed to DAC
				0	1	Q channel processing routed to DAC
				1	0	Modulator real output routed to DAC
				1	1	Modulator imaginary output routed to DAC
HILBERT	6	I	0	1: With MODDUAL on, Hilbert transform on		
MODDUAL	5	I	0	0: Modulator uses a single channel 1: Modulator uses both I and Q channels		
SIDEBAND	4	I	0	0: With MODDUAL on, upper sideband rejected 1: With MODDUAL on, lower sideband rejected		
MOD[1:0]	[3:2]	I	00	00: No modulation 01: $f_s/2$ modulation 10: $f_s/4$ modulation 11: $f_s/8$ modulation		

AD9786

Table 16.

DCLKCRC(05)	Bit	Direction	Default	Description				
DATAADJ[3:0]	[7:4]	I	0000	DATACLK offset (twos complement representation) 0111: +7 : 0000: 0 : 1000: -8				
MODSYNC	3	I	00	0: Channel data rate clock synchronizer mode 1: State machine clock synchronizer mode				
MODADJ[2:0]	[2:0]	I	000		Modulator coefficient offset			
						$f_s/8$	$f_s/4$	$f_s/2$
				000		1	1	1
				001		+1/ $\sqrt{2}$	0	-1
				010		0	-1	1
				011		-1/ $\sqrt{2}$	0	-1
				100		-1	+1	+1
				101		-1/ $\sqrt{2}$	0	-1
				110		0	-1	+1
111	+1/ $\sqrt{2}$	0	-1					

Table 17.

VERSION(0D)	Bit	Direction	Default	Description
VERSION[3:0]	[3:0]	O		Hardware version identifier

Table 18.

CALMEMCK(OE)	Bit	Direction	Default	Description
CALMEM	[5:4]	O	00	Calibration memory 00: Uncalibrated 01: Self-calibration 10: Factory calibration 11: User input
CALCKDIV[2:0]	[2:0]	I	00	Calibration clock divide ratio from channel data rate 000: /32 001: /64 : 110: /2048 111: /4096

Table 19.

MEMRDWR(OE)	Bit	Direction	Default	Description
CALSTAT	7	O	0	0: Self-calibration cycle not complete 1: Self-calibration cycle complete
CALEN	6	I	0	1: Self-calibration in progress
XFERSTAT	5	O	0	0: Factory memory transfer not complete 1: Factory memory transfer complete
XFEREN	4	I	0	1: Factory memory transfer in progress
SMEMWR	3	I	0	1: Write static memory data from external port
SMEMRD	2	I	0	1: Read static memory to external port
FMEMRD	1	I	0	1: Read factory memory data to external port
UNCAL	0	I	0	1: Use uncalibrated

Table 20.

MEMADDR(10)	Bit	Direction	Default	Description
MEMADDR [7:0]	[7:0]	I/O	00000000	Address of factory or static memory to be accessed

Table 21.

MEMDATA(11)	Bit	Direction	Default	Description
MEMDATA [5:0]	[5:0]	I/O	000000	Data or factory or static memory access

Table 22.

DCRCSTAT(12)	Bit	Direction	Default	Description
DCRCSTAT (2)	2	O	0	0: With DATACLK CRC on, lock has never been achieved 1: With DATACLK CRC on, lock has been achieved at least once
DCRCSTAT(1)	1	O	0	0: With DATACLK CRC on, system is currently not locked 1: With DATACLK CRC on, system is currently locked
DCRCSTAT(0)	0	O	0	0: With DATACLK CRC on, system is currently locked 1: With DATACLK CRC on, system lost lock due to jitter

DIGITAL FILTER SPECIFICATIONS

DIGITAL INTERPOLATION FILTER COEFFICIENTS

Table 23. Stage 1 Interpolation Filter Coefficients

Lower Coefficient	Upper Coefficient	Integer Value
H(1)	H(43)	9
H(2)	H(42)	0
H(3)	H(41)	-27
H(4)	H(40)	0
H(5)	H(39)	65
H(6)	H(38)	0
H(7)	H(37)	-131
H(8)	H(36)	0
H(9)	H(35)	239
H(10)	H(34)	0
H(11)	H(33)	-407
H(12)	H(32)	0
H(13)	H(31)	665
H(14)	H(30)	0
H(15)	H(29)	-1070
H(16)	H(28)	0
H(17)	H(27)	1764
H(18)	H(26)	0
H(19)	H(25)	-3273
H(20)	H(24)	0
H(21)	H(23)	10358
H(22)		16384

Table 24. Stage 2 Interpolation Filter Coefficients

Lower Coefficient	Upper Coefficient	Integer Value
H(1)	H(19)	19
H(2)	H(18)	0
H(3)	H(17)	-120
H(4)	H(16)	0
H(5)	H(15)	436
H(6)	H(14)	0
H(7)	H(13)	-1284
H(8)	H(12)	0
H(9)	H(11)	5045
H(10)		8192

Table 25. Stage 3 Interpolation Filter Coefficients

Lower Coefficient	Upper Coefficient	Integer Value
H(1)	H(11)	7
H(2)	H(10)	0
H(3)	H(9)	-53
H(4)	H(8)	0
H(5)	H(7)	302
H(6)		512

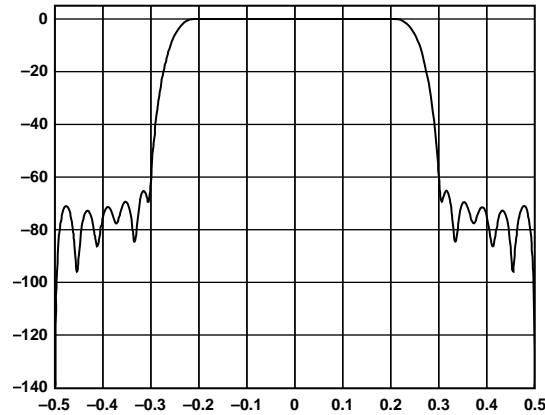

Figure 41. 2x Interpolation Filter Response

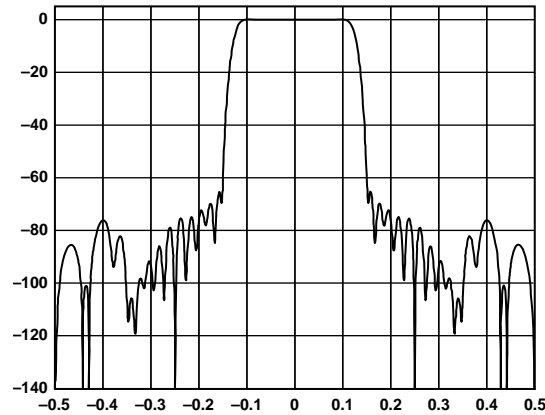

Figure 42. 4x Interpolation Filter Response

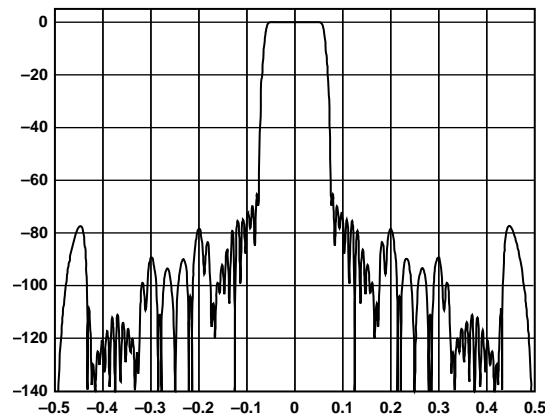

Figure 43. 8x Interpolation Filter Response

CLOCK/DATA TIMING

Table 26. Data Port Synchronization

DCLKEXT 0x02, Bit 3	MODSYNC 0x05, Bit 3	DCLKCRC 0x02, Bit 2	Mode	Function
1	0	X	DATACLK Master	Channel data rate clock output
1	1	X	Modulator Master	Modulator synchronization DATACLK output
0	0	0	External Sync Mode	DATACLK inactive, DACCLK synchronous with external data
0	0	1	DATACLK Slave	DATACLK input, data rate clock, data recovery on
0	1	0	Low Setup/Hold	DATACLK input, input data synchronous with DATACLK
0	1	1	Modulator Slave	Input modulator synchronizer DATACLK input

Two-Port Data Input Mode (DATACLK Master)

With the interpolation set to 1×, the DATACLK output is a delayed and inverted version of DACCLK at the same frequency. Note that DACCLK refers to the differential clock inputs applied at Pin 5 and Pin 6. As Figure 44 and Figure 45 show, there is a constant delay between the edges of DACCLK and DATACLK.

The DCLKPOL bit (Register 0x02, Bit 4) allows the data to be latched into the AD9786 upon either the rising or falling edge of DACCLK. With DCLKPOL = 0, the data is latched in upon the falling edge of DACCLK, as shown in Figure 44. With DCLKPOL = 1, as shown in Figure 45, data is latched in upon the rising edge of DACCLK. The setup and hold times are always with respect to the latching edge of DACCLK.

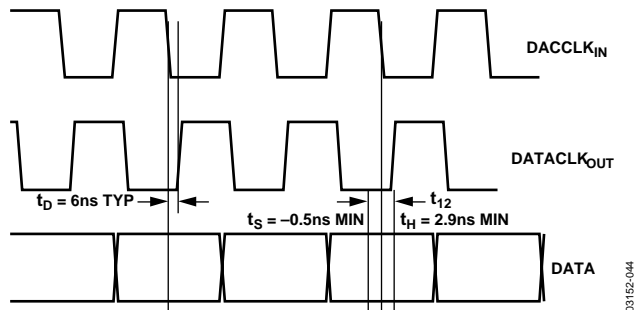

Figure 44. Data Timing, 1× Interpolation, DCLKPOL = 0

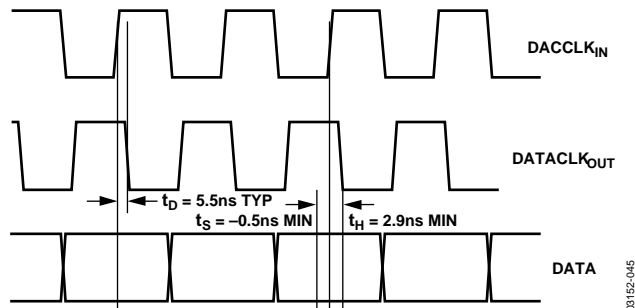

Figure 45. Data Timing, 1× Interpolation, DCLKPOL = 1

With the interpolation set to 2×, the DACCLK input runs at twice the speed of the DATACLK. Data is latched into the digital inputs of the AD9786 upon every other rising edge of DACCLK, as shown in Figure 47 and Figure 48. With DCLKPOL = 0, as shown in Figure 47, the latching edge of DACCLK is the rising edge that occurs just before the falling edge of DATACLK. With DCLKPOL = 1, as in Figure 48, the latching edge of DACCLK is the rising edge of DACCLK that occurs just before the rising edge of DATACLK. The setup and hold time values are identical to those in Figure 44 and Figure 45.

Note that there is a slight difference in the delay from the rising edge of DACCLK to the falling edge of DATACLK, and the delay from the rising edge of DACCLK to the rising edge of DATACLK. As Figure 46 shows, the DATACLK duty cycle is slightly less than 50%. This is true in all modes.

With the interpolation set to 4× or 8×, the DACCLK input runs at 4× or 8× the speed of the DATACLK output. The data is latched in upon a rising edge of DACCLK, similar to the 2× interpolation mode.

However, the latching edge is every fourth edge in 4× interpolation mode and every eighth edge in the 8× interpolation mode. Similar to operation in the 2× interpolation mode, with DCLKPOL = 0, the latching edge of DACCLK is the rising edge that occurs just before the falling edge of DATACLK. With DCLKPOL = 1, the latching edge of DACCLK is the rising edge that occurs just before the rising edge of DATACLK. The setup and hold time values are identical to those in 1× and 2× interpolation.

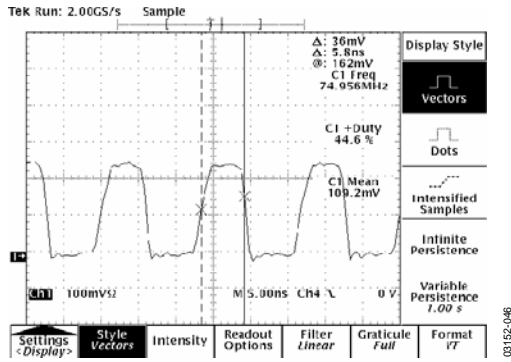

Figure 46. DACCLK Duty Cycle

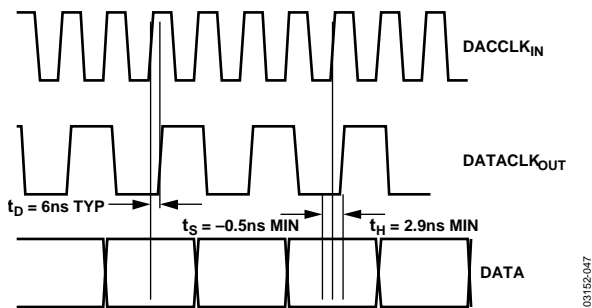

Figure 47. Data Timing, 2x Interpolation, DCLKPOL = 0

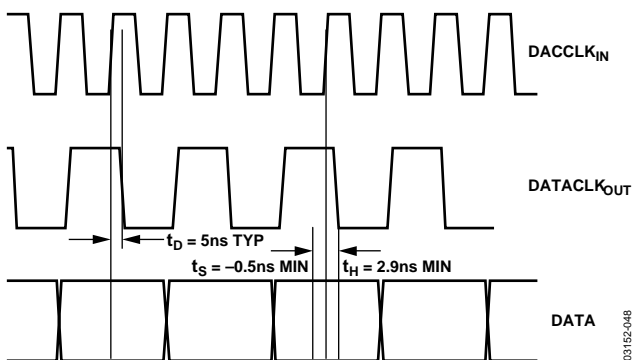

Figure 48. Data Timing, 2x Interpolation, DCLKPOL = 1

DATACLK Slave Mode (Data Recovery On)

DATACLK (Pin 31) can be used as an input to synchronize multiple AD9786s. A clock generated by an AD9786 operating in master mode, or a clock from an external source, can be used to drive DATACLK.

In this mode, two clocks are required to be applied to the AD9786. A clock running at the DAC sample rate, referred to as DACCLK, must be applied to the differential inputs (Pin 5 and Pin 6) of the AD9786. As described previously, a clock at the input sample rate must also be applied to Pin 31 (DATACLK). An internal DLL synchronizes the two applied clocks. The timing relationships between the input data, DATACLK, and DACCLK are given in Figure 49 and Figure 50.

Note that DCLKPOL (Register 0x02, Bit 4) can be used to select the edge of DACCLK upon which the input data is latched.

There is a defined setup-and-hold window with respect to input data and the latching edge of DACCLK. There is also a required timing relationship between DATACLK and DACCLK. This is referred to in Figure 49 and Figure 50 as t_{ST} and t_{HT} (setup and hold for transition). For example, with DCLKPOL set to Logic 0, the input data latches upon the first rising edge of DACCLK that occurs more than 1.5 ns before the falling edge of DATACLK. DACCLK should not be given a rising edge in the window of 500 ps to 1.5 ns before the latching edge (falling edge when DCLKPOL = 0, rising edge when DCLKPOL = 1) of DATACLK. Failure to account for this timing relationship could result in corrupt data.

There are three status bits available for a read that allow the user to verify DLL lock. These are Bit 0, Bit 1, and Bit 2 (DRCSTAT) in Register 0x12.

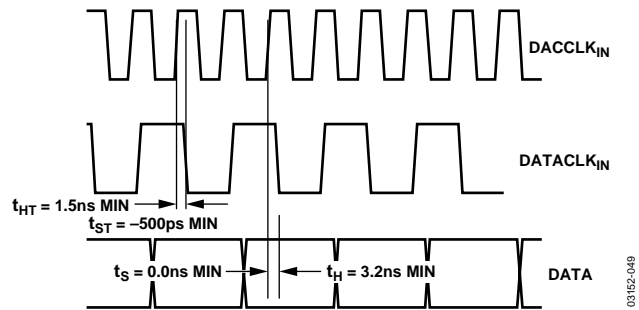

Figure 49. Slave Mode Timing, 2x Interpolation, DCLKPOL = 0

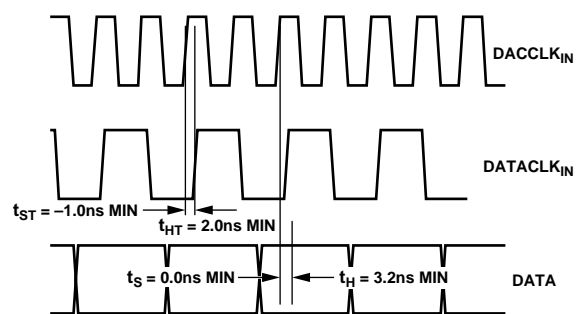

Figure 50. Slave Mode Timing, 2x Interpolation, DCLKPOL = 1

Low Setup/Hold Mode (DATACLK Input, Data Recovery Off)

Some applications might require that digital input data be synchronized with the DATACLK input, rather than DACCLK. For these applications, the AD9786 can be programmed for low setup/hold mode by entering the values in Table 26 into the SPI registers. With data recovery off and the MODSYNC bit set to Logic 1, the AD9786 latches data in upon the rising or falling edge of DATACLK input, depending on the state of DCLKPOL.

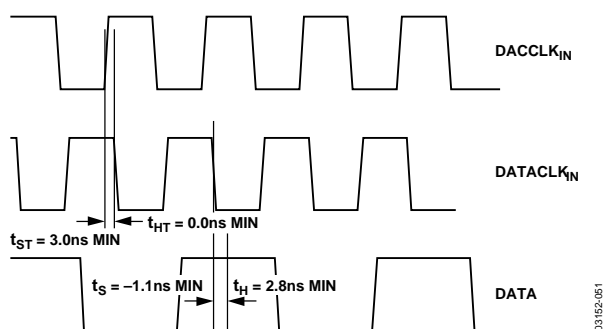

Figure 51. Low Setup and Hold Mode Timing, 1× Interpolation, DCLKPOL = 0

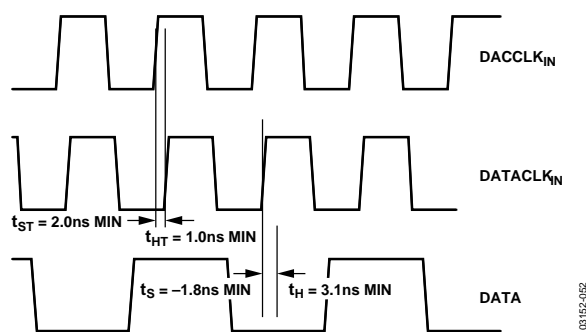

Figure 52. Low Setup and Hold Mode Timing, 1× Interpolation, DCLKPOL = 1

External Sync Mode

In the external sync mode, the DATACLK is programmed as an input but is not used. Applying a DATACLK input while in this mode has no effect. The digital input data is synchronized solely to the DACCLK input. With 1× interpolation, the data input is latched upon every rising edge of DACCLK. The challenge is that the user has no way of knowing exactly which edge is the latching edge when the interpolating filters are in use. In 2×, 4×, and 8× interpolation modes, the latching edge of DACCLK is every 2nd, 4th, or 8th edge, respectively.

With the 2 ns keep-out window, shown in Figure 53, there is a strong possibility of violating setup and hold times, especially at high speeds. It is recommended that users sense the DAC output noise floor for setup and hold violations. If setup and hold is violated, DCLKPOL can be switched. The effect of switching the state of DCLKPOL is that the latching edge is moved by one, two, or four DACCLK cycles if the AD9786 is in 2×, 4×, or 8× interpolation modes, respectively. Note that in this mode, the DATAADJ bits have no effect.

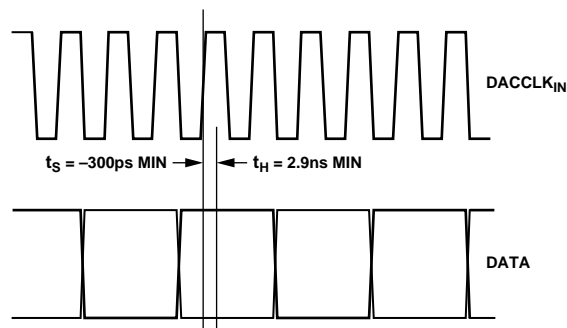

Figure 53. External Sync Mode with 2× Interpolation

Note that when using the AD9786 in external sync mode with 1× interpolation, that functionality is identical to master mode, except that DATACLK out is not available. That is, with DATACLKPOL = 0, data is latched on the falling edge of DACCLK, and with DATACLKPOL = 1, data is latched on the rising edge of DACCLK.

DATAADJUST Synchronization

When designing the digital interface for high speed DACs, care must be taken to ensure that the DAC input data meets setup and hold requirements. Often, compensation must be used in the clock delay path to the digital engine driving the DAC. The AD9786 has the on-chip capability to vary the latching edge of DACCLK. With the interpolation function enabled, this allows the user the choice of multiple edges upon which to latch the data. For instance, if the AD9786 is using 8× interpolation, the user can latch from one of eight edges before the rising edge of DATACLK, or seven edges after this rising edge. The specific edge upon which data is latched is controlled by SPI Register 0x05, Bits 7:4. Table 27 shows the relationship of the latching edge of DACCLK and DATACLK with the various settings of the DATAADJ bits.

Table 27. DATAADJ Values for Latching Edge Sync

SPI Register 0x05				Latching Edge Write DATACLK
Bit 7	Bit 6	Bit 5	Bit 4	
0	0	0	0	0
0	0	0	1	+1
0	0	1	0	+2
0	0	1	1	+3
0	1	0	0	+4
0	1	0	1	+5
0	1	1	0	+6
0	1	1	1	+7
1	0	0	0	-8
1	0	0	1	-7
1	0	1	0	-6
1	0	1	1	-5
1	1	0	0	-4
1	1	0	1	-3
1	1	1	0	-2
1	1	1	1	-1

Note that the data in Figure 44 to Figure 53 was taken with the DATAADJ default of 0000. Changing the DATAADJ values allows the user to select the specific edge of DACCLK upon which the input data is latched. This can be done in master mode, but it is most useful in slave mode. For more information on using DATAADJ and MODADJ to synchronize multiple AD9786s, see *Analog Devices Application Note 747*. Table 27 lists the values available for 8× interpolation, which, in turn, provides a choice of 16 edges to sync data. With 4× interpolation, there is a choice of eight edges, and the relevant values from Table 27 are 0000, 0010, 0100, 0110, 1000, 1010, 1100, and 1110. These options allow latching edge placement from +3 cycles to -4 cycles. In 2× interpolation, four edges are available, and the relevant values from Table 27 are 0000, 0100, 1000, and 1100. The choices for DATAADJ are diminished to +1 cycle to -2 cycles.

Figure 54, Figure 55, and Figure 56 show the alignment for the latching edge of DACCLK with 4× interpolation and different settings for DATAADJ. In Figure 54, the AD9786 is in DATACLK master mode. DATAADJ is set to 0000, with DCLKPOL set to 0 so that the latching edge of DACCLK is immediately before the rising edge of DATACLK. The data transitions shown in Figure 54 are synchronous with the DACCLK, so that DACCLK and input data are constant with respect to each other.

The only visible change when DATAADJ is altered is that DATACLK moves, indicating the latching edge has moved as well. Note that in DATACLK master mode, when DATAADJ is altered, the latching edge with respect to DATACLK remains the same.

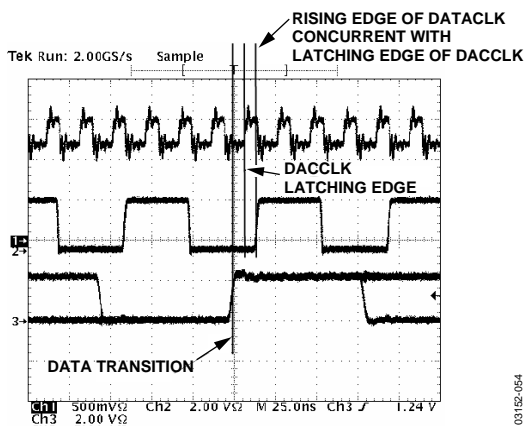

Figure 54. DATAADJ = 0000

Figure 55 shows the same conditions, but with DATAADJ set to 1111. This moves DATACLK to the left in the plot, indicating that it occurs one DACCLK cycle before it did in Figure 54; therefore, the latching edge of DACCLK also occurs one cycle earlier.

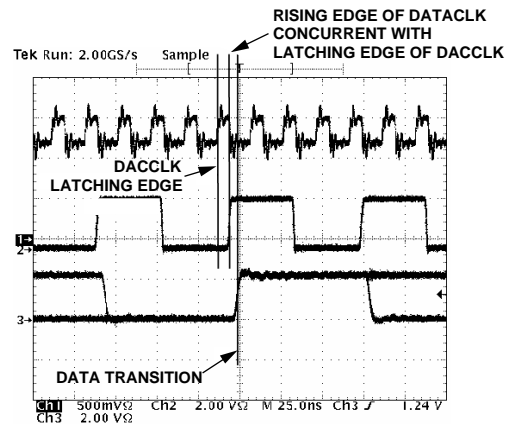

Figure 55. DATAADJ = 1111

Figure 56 shows the same conditions, with DATAADJ set to 0001; therefore, DATACLK moves to the right in the plot. This indicates that it occurs one DACCLK cycle after it did in Figure 54; therefore, the latching edge of DACCLK also occurs one cycle later.

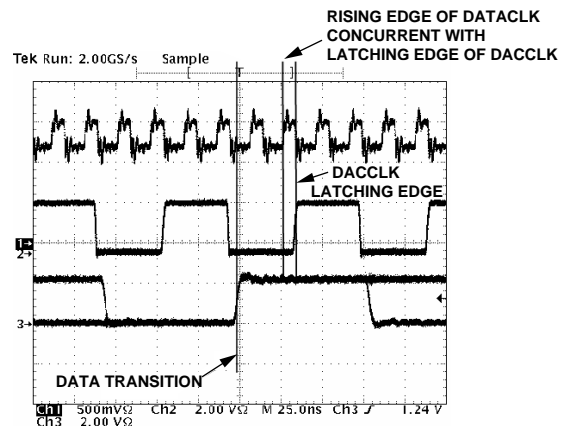

Figure 56. DATAADJ = 0001

Interpolation Modes

Table 28. Interpolation Modes

INTERP[1]	INTERP[0]	Mode
0	0	No interpolation
0	1	×2 interpolation
1	0	×4 interpolation
1	1	×8 interpolation

Interpolation is the process of increasing the number of points in a time domain waveform by approximating points between the input data points on a uniform time grid. This produces a higher output data rate. Applied to an interpolation DAC, a digital interpolation filter is used to approximate the interpolated points, having an output data rate increased by the interpolation factor. Interpolation filter responses are achieved by cascading individual digital filter banks, whose filter coefficients are given in Table 23, Table 24, and Table 25. Filter responses are shown in Figure 57, which shows the interpolation filters of the AD9786 under different interpolation rates, normalized to the input data rate, f_{SIN} .

The digital filter's frequency domain response exhibits symmetry about half the output data rate and dc. It causes images of the input data to be shaped by the interpolation filter's frequency response. This has the advantage of causing input data images that fall in the stop band of the digital filter to be rejected by the stop-band attenuation of the interpolation filter, while input

data images falling in the interpolation filter pass band are passed. In band-limited applications, the images at the output [of the DAC must be limited by an analog reconstruction filter. The complexity of the analog reconstruction filter is determined by the proximity of the closest image to the required signal band. Higher interpolation rates yield larger stop-band regions, suppressing more input images and resulting in a much relaxed analog reconstruction filter.

A DAC shapes its output with a sinc function, having a null at the sampling frequency of the DAC. The higher the DAC sampling rate compared to the input signal bandwidth, the less the DAC sinc function shapes the output. The higher the interpolation rate, the more input data images fall in the interpolation filter stop band and are rejected; the bandwidth between passed images is larger with higher interpolation factors. The sinc function shaping is also reduced with a higher interpolation factor.

Table 29. Sinc Shaping at Band Edge of Interpolation Filters

Mode	Sinc Shaping @ $0.43 f_{SIN}$ (dB)	Bandwidth to First Image
No interpolation	-2.8241	f_{SIN}
×2 interpolation	-0.6708	$2 f_{SIN}$
×4 interpolation	-0.1657	$4 f_{SIN}$
×8 interpolation	-0.0413	$8 f_{SIN}$

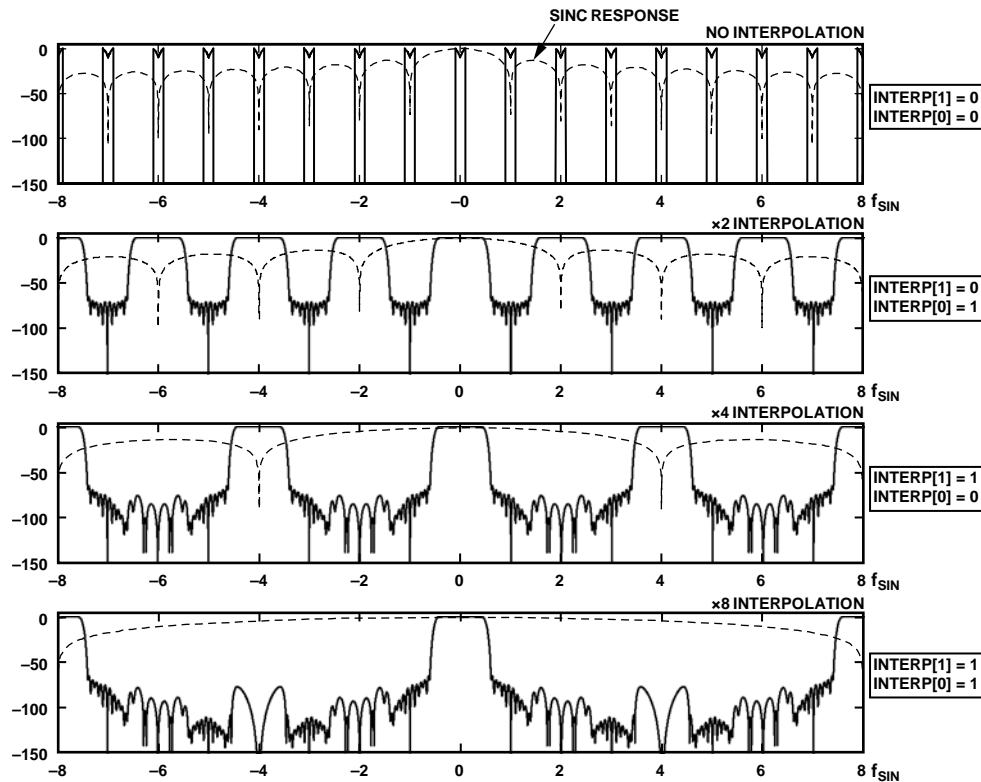

Figure 57. Interpolation Modes

REAL AND COMPLEX SIGNALS

A complex signal contains both magnitude and phase information. Given two signals at the same frequency, if the leading signal in phase is cosinusoidal and the lagging signal is sinusoidal, information pertaining to the magnitude and phase of a combination of the two signals can be derived; the combination of the two signals can be considered a complex signal. The cosine and sine can be represented as a series of exponentials, recalling that a multiplication by j is a counterclockwise rotation about the Re/Im plane. The phasor representation of a complex signal with Frequency f is shown in Figure 58.

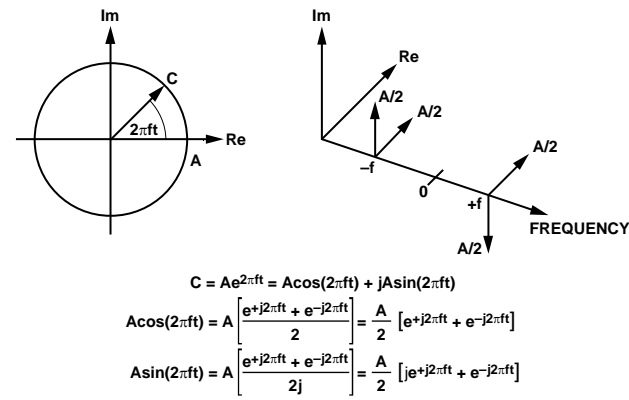

Figure 58. Complex Phasor Representation

The cosine term—referred to as the real in-phase, or I component, of a complex signal—represents a signal on the real plane with mirror symmetry about dc. The sine term—referred to as the imaginary quadrature, or Q complex signal component—represents a signal on the imaginary plane with mirror asymmetry about dc.

The AD9786 has two channels of interpolation filters, allowing both I and Q components to be shaped by the same filter transfer function. The interpolation filter's frequency response is a real transfer function. Two DACs are required to represent a complex signal. A single DAC can only synthesize a real signal. When a DAC synthesizes a real signal, negative frequency components fold onto the positive frequency axis. If the input to the DAC is mirrored symmetrically about dc, the negative frequency components fold directly onto the positive frequency components in phase-producing, constructive signal summation. If the input to the DAC is not mirrored symmetrically about dc, negative frequency components might not be in phase with positive frequency components, causing destructive signal summation. Different applications might benefit from either type of signal summation.

MODULATION MODES**Table 30. Single-Channel Modulation**

MODDUAL	CHANNEL	MOD[1]	MOD[0]	Mode
0	0	0	0	I channel, no modulation
0	0	0	1	I channel, modulation by $f_{DAC}/2$
0	0	1	0	I channel, modulation by $f_{DAC}/4$
0	0	1	1	I channel, modulation by $f_{DAC}/8$
0	1	0	0	Q channel, no modulation
0	1	0	1	Q channel, modulation by $f_{DAC}/2$
0	1	1	0	Q channel, modulation by $f_{DAC}/4$
0	1	1	1	Q channel, modulation by $f_{DAC}/8$

Either channel of the AD9786 interpolation filter channels can be routed to the DAC and modulated. In single-channel operation, the input data can be modulated by a real sinusoid; the input data and the modulating sinusoid contain both positive and negative frequency components. A double side-band output results when modulating two real signals. At the DAC output, the positive and negative frequency components add in phase, resulting in constructive signal summation.

As the modulating sinusoidal frequency becomes a larger fraction of the DAC update rate, f_{DAC} , the sinc function of the DAC shapes the modulated signal bandwidth more, and the first image moves closer.

Because the AD9786 interpolation filter pass band represents a large portion of the input data Nyquist band, it is possible for modulated signal bands to touch or overlap images if sufficient interpolation is not used under certain modulation and interpolation modes.

Figure 59 shows the effects of $f_{DAC}/8$ modulation when using $8\times$ interpolation. Figure 60 to Figure 62 show the effects of real modulation under all interpolation modes. The sinc shaping at the corners of the modulated signal band and the bandwidth to the first image for those cases whose pass bands do not touch or overlap are tabulated.

Table 31. Synthesis Bandwidth vs. Interpolation Modes

Modulation	Interpolation			
	None	$\times 2$	$\times 4$	$\times 8$
None	f_{SIN}	$2 f_{SIN}$	$4 f_{SIN}$	$8 f_{SIN}$
$f_{DAC}/2$	f_{SIN}	$2 f_{SIN}$	$4 f_{SIN}$	$8 f_{SIN}$
$f_{DAC}/4$	Overlap	Touching	$2 f_{SIN}$	$4 f_{SIN}$
$f_{DAC}/8$	Overlap	Overlap	Touching	$6 f_{SIN}$

Table 32. Modulated Pass-Band Edges Sinc Shaping (Lower/Upper)

Modulation	Interpolation			
	None	$\times 2$	$\times 4$	$\times 8$
None	0 -2.8241	0 -0.6708	0 -0.1657	0 -0.0413
$f_{DAC}/2$	-0.0701 -22.5378	-1.1932 -9.1824	-2.3248 -6.1190	-3.0590 -4.9337
$f_{DAC}/4$	Overlap	Touching	-0.2921 -1.9096	-0.5974 -1.3607
$f_{DAC}/8$	Overlap	Overlap	Touching	-0.0727 -0.4614

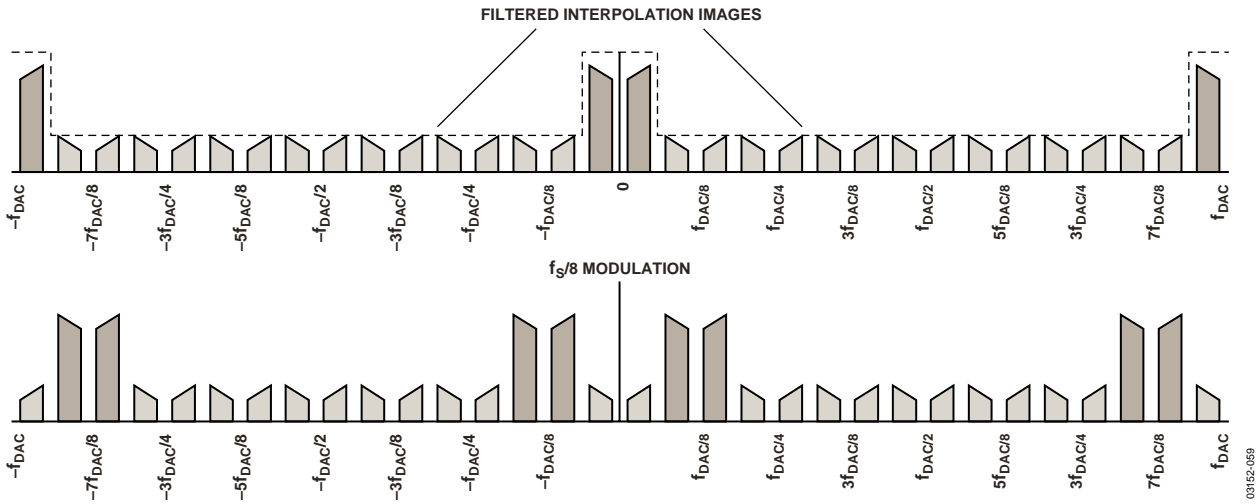

Figure 59. Double Sideband Modulation

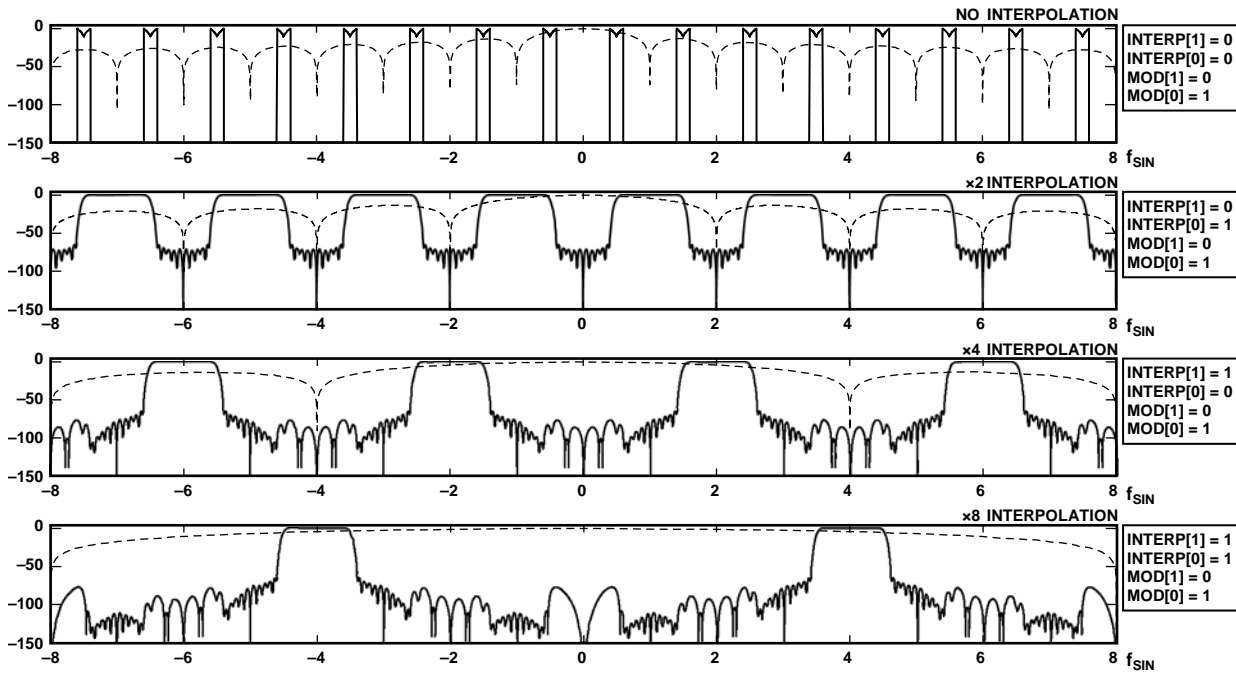

Figure 60. Real Modulation by $f_{DAC}/2$ Under All Interpolation Modes

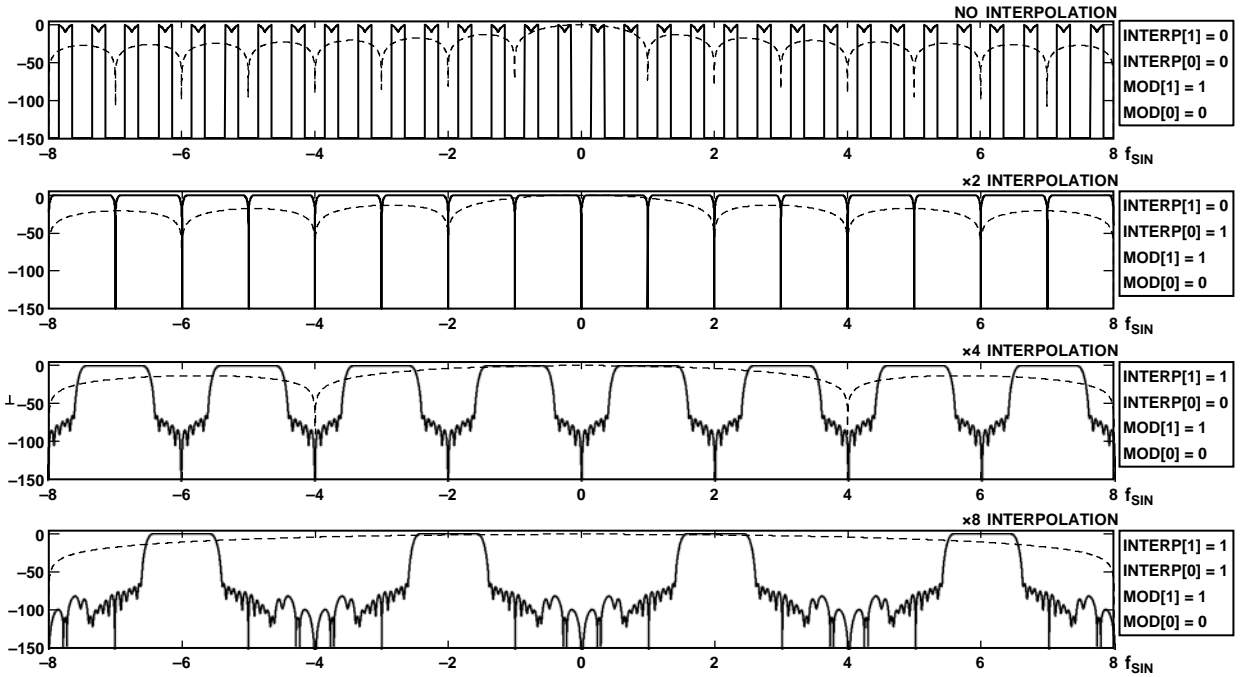

Figure 61. Real Modulation by $f_{DAC}/4$ Under All Interpolation Modes

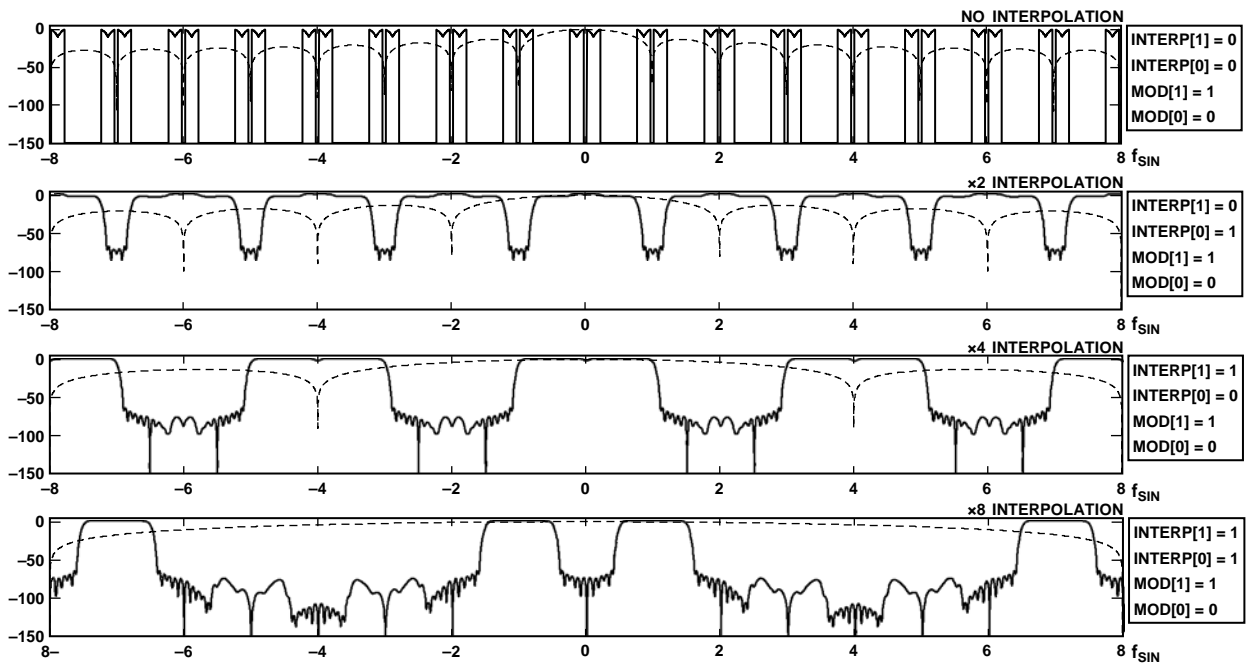

Figure 62. Real Modulation by $f_{DAC}/8$ Under All Interpolation Modes

Table 33. Dual-Channel Complex Modulation

MODDUAL	CHANNEL	MOD[1]	MOD[0]	Mode
0	0	0	0	Real output, no modulation
0	0	0	1	Real output, modulation by $f_{DAC}/2$
0	0	1	0	Real output, modulation $f_{DAC}/4$
0	0	1	1	Real output, modulation $f_{DAC}/8$
0	1	0	0	Image output, no modulation
0	1	0	1	Image output, modulation by $f_{DAC}/2$
0	1	1	0	Image output, modulation by $f_{DAC}/4$
0	1	1	1	Image output, modulation by $f_{DAC}/8$

In dual-channel mode, the two channels can be modulated by a complex signal, with either the real or imaginary modulation result directed to the DAC. Assume initially, as in Figure 63, that the complex modulating signal is defined for a positive frequency only. This causes the output spectrum to be translated in frequency by the modulation factor only. No additional sidebands are created as a result of the modulation process; therefore, the bandwidth to the first image from the baseband bandwidth is the same as the output of the interpolation filters. Furthermore, pass bands do not overlap or touch. The sinc shaping at the corners of the modulated signal band is tabulated in Table 34. Figure 64, Figure 65, and Figure 66 show the effects of complex modulation with varying interpolation rates.

Table 34. Complex Modulated Pass-Band Edges Sinc Shaping (Lower/Upper)

Modulation	Interpolation			
	None	x2	x4	x8
None	0	0	0	0
$f_{DAC}/2$	-2.8241	-0.6708	-0.1657	-0.0413
$f_{DAC}/4$	-0.0701	-1.1932	-2.3248	-3.0590
$f_{DAC}/8$	-0.4680	-0.0175	-0.2921	-0.5974
	-6.0630	-3.3447	-1.9096	-1.3607
	-1.3723	-0.1160	-0.0044	-0.0727
	-4.9592	-1.7195	-0.7866	-0.4614

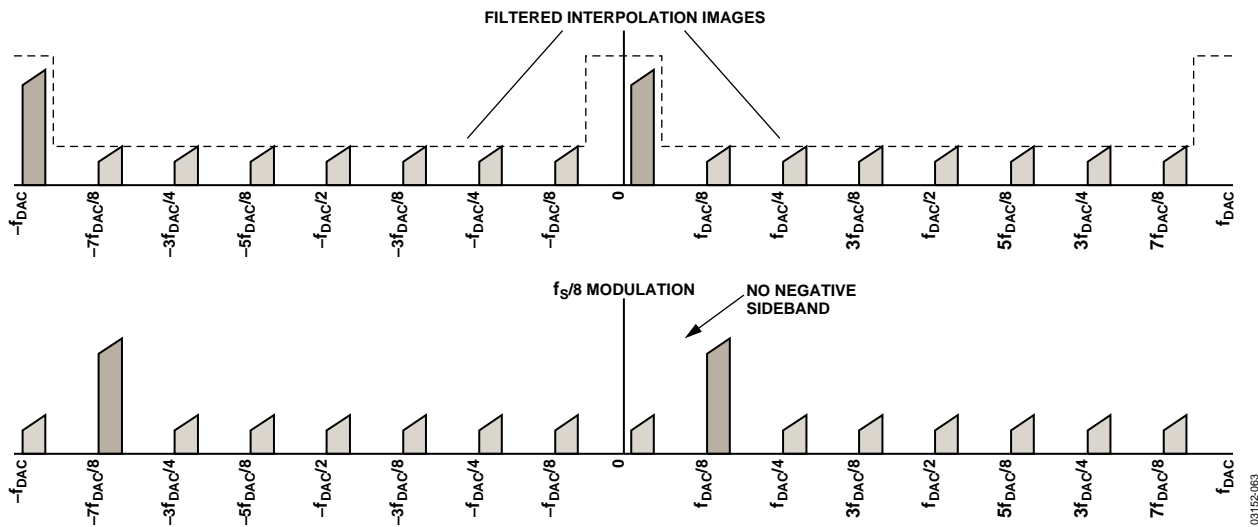

Figure 63. Complex Modulation

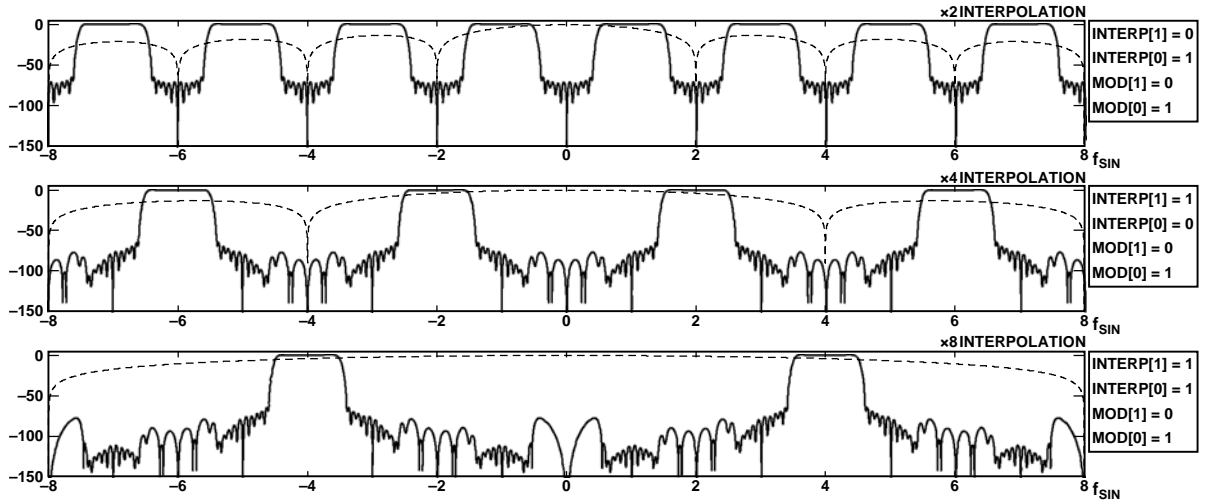

Figure 64. Complex Modulation by $f_{DAC}/2$ Under All Interpolation Modes

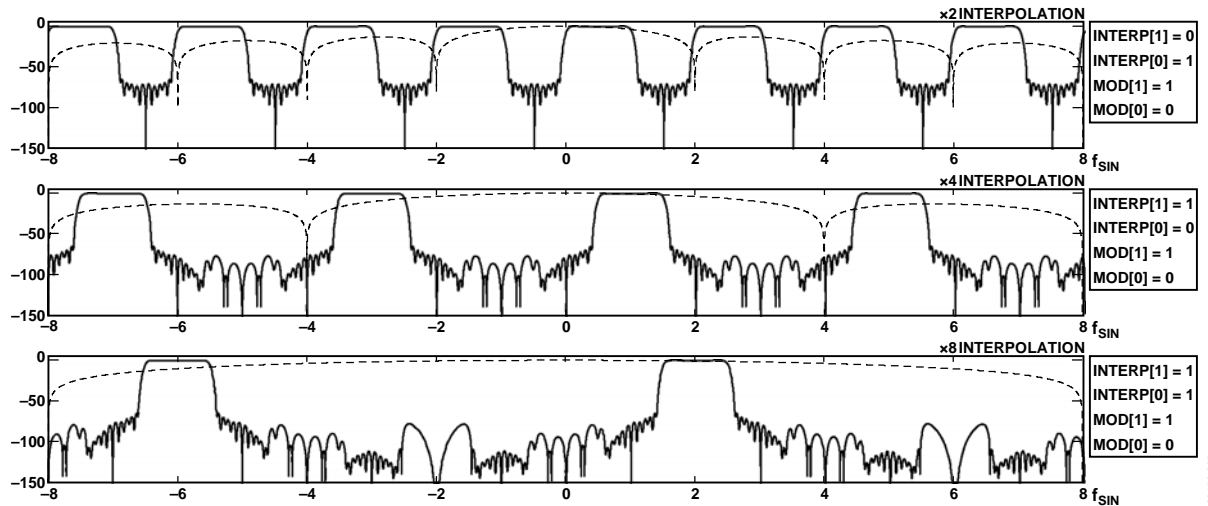

Figure 65. Complex Modulation by $f_{DAC}/4$ Under All Interpolation Modes

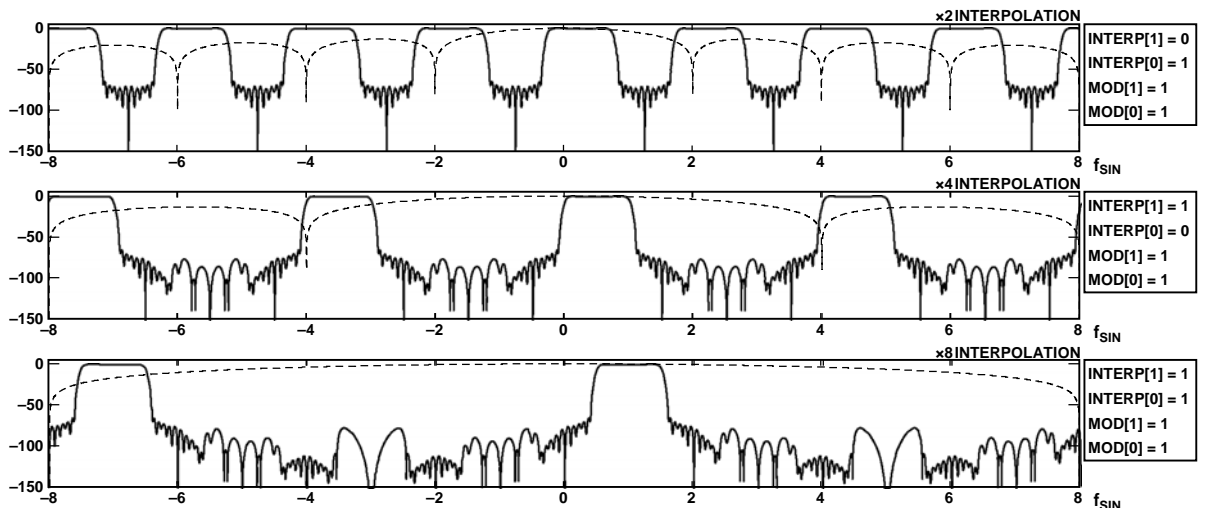

Figure 66. Complex Modulation by $f_{DAC}/8$ Under All Interpolation Modes

POWER DISSIPATION

The AD9786 has seven power-supply domains: two 3.3 V analog domains (AVDD1 and AVDD2), two 2.5 V analog domains (ADVDD and ACVDD), one 2.5 V clock domain (CLKVDD), and two digital domains (DVDD, which runs from 2.5 V; and DRVDD, which runs from 3.3 V).

The current needed for the 3.3 V analog supplies, AVDD1 and AVDD2, is consistent across speed and varying modes of the AD9786. Nominally, the current for AVDD1 is 29 mA across all speeds and modes, whereas the current for AVDD2 is 20 mA.

The current for the 2.5 V analog supplies and the digital supplies varies depending on speed and mode of operation. Figure 67, Figure 68, and Figure 69 show this variation. Note that CLKVDD, ADVDD, and ACVDD vary with clock speed and interpolation rate, but not with modulation rate.

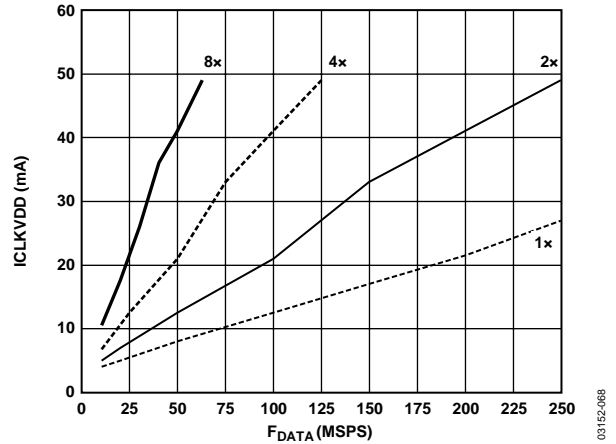

Figure 68. CLKVDD Supply Current vs. Clock Speed and Interpolation Rates

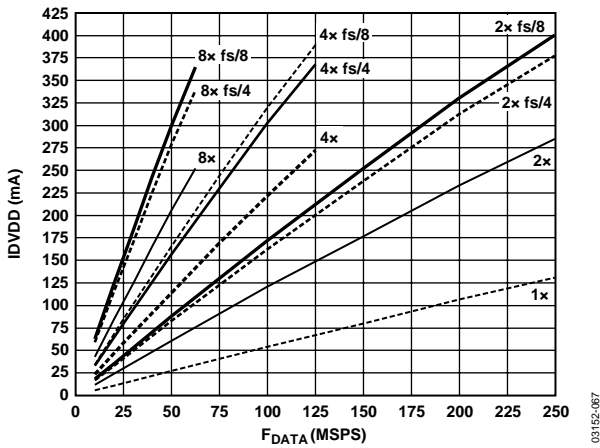

Figure 67. DVDD Supply Current vs. Clock Speed, Interpolation, and Modulation Rates

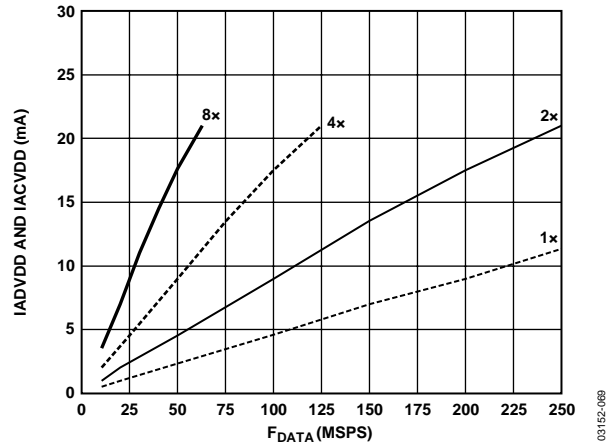

Figure 69. ADVDD and ACVDD Supply Current vs. Clock Speed and Interpolation Rates

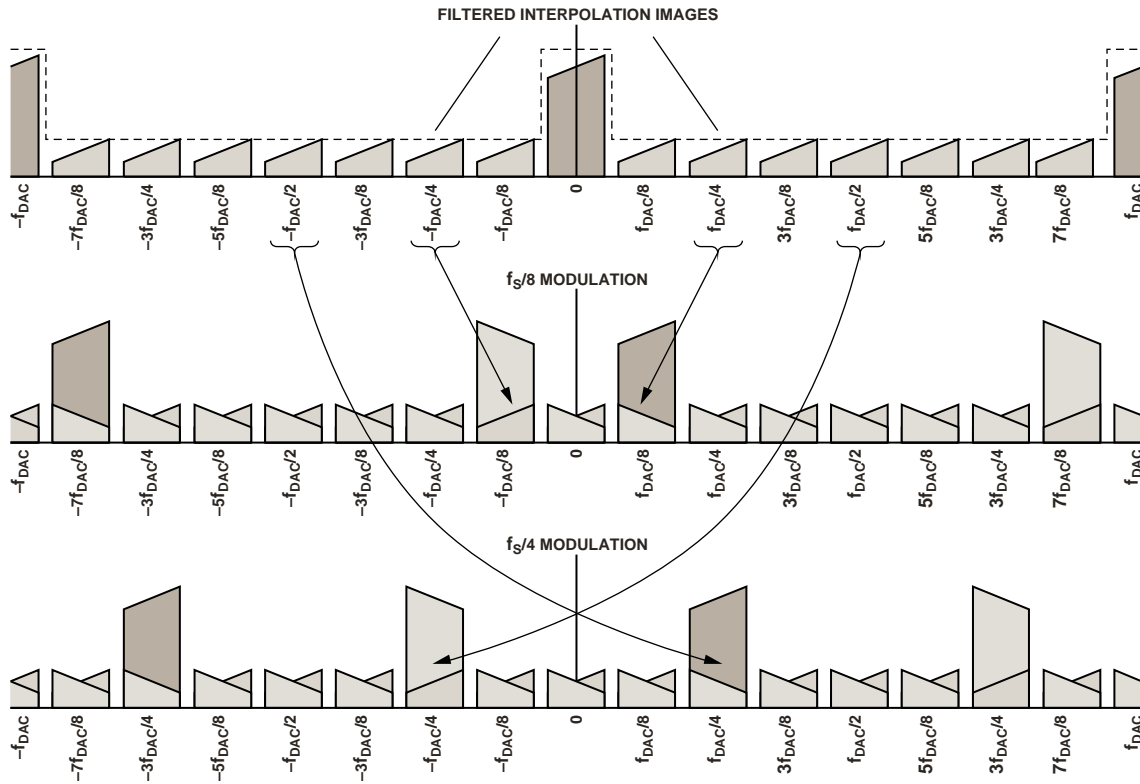

Figure 70. Complex Modulation with Negative Frequency Aliasing

Table 35. Dual Channel Complex Modulation with Hilbert

Hilbert	Mode
0	Hilbert transform off
1	Hilbert transform on

When complex modulation is performed, the entire spectrum is translated by the modulation factor. If the resulting modulated spectrum is not mirrored symmetrically about dc when the DAC synthesizes the modulated signal, negative frequency components fall on the positive frequency axis and can cause destructive summation of the signals, as shown in Figure 70. For some applications, this can distort the modulated output signal.

The operation of the Hilbert transform (Figure Z) rotates the negative frequency components of Figure Y by $+\pi/2$, and the positive frequency components of Figure Y by $-\pi/2$. The result of the Hilbert transform output is then summed with the complex signal in the main signal path. The result is that negative frequencies are cancelled and, therefore, do not fold back into the positive side of the frequency spectrum. The Δt block in the main signal path offsets the delay inherent in the Hilbert transform (nine DAC clock cycle delay). When the DAC synthesizes the modulated output, there are no negative frequency components to fold onto the positive frequency axis out of phase; consequently, no distortion is produced as a result of the modulation process.

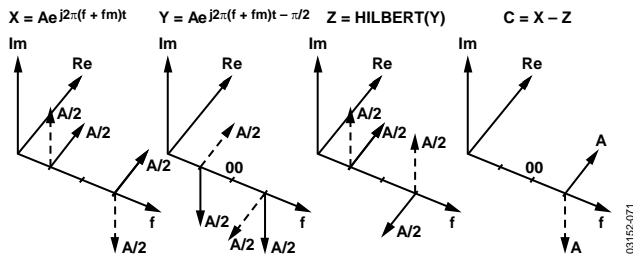

Figure 71. Negative Frequency Image Rejection

In Figure 71, Figure X represents a complex signal typically found in the AD9786 signal path. Figure Y is identical to Figure X, but it is shifted by $\pi/2$. The phase shifting in the AD9786 occurs because the digital LO driving the digital quadrature modulator in the Hilbert transform path is phase shifted by $\pi/2$.

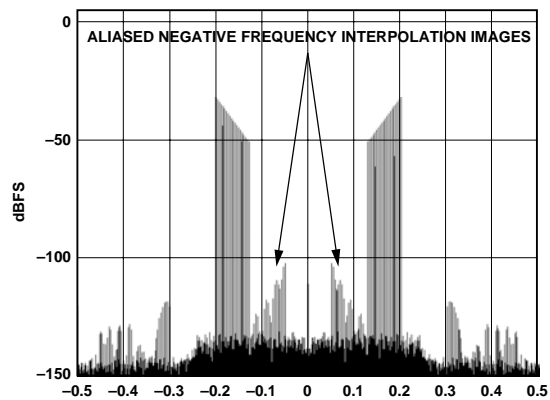

Figure 72. Negative Frequency Aliasing Distortion

Figure 72 shows this effect at the DAC output for a signal mirrored asymmetrically about dc that is produced by complex modulation without a Hilbert transform. The signal bandwidth was narrowed to show the aliased negative frequency interpolation images.

In contrast, Figure 73 shows the same waveform with the Hilbert transform applied. Clearly, the aliased interpolation images are not present.

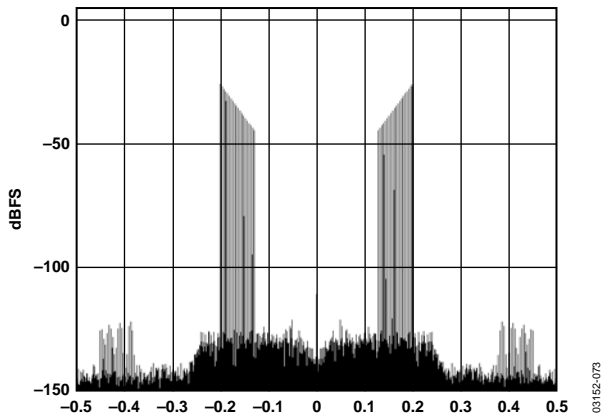

Figure 73. Effects of Hilbert Transform

If the output of the AD9786 is used with a quadrature modulator, negative frequency images are cancelled without the need for a Hilbert transform.

HILBERT TRANSFORM IMPLEMENTATION

The Hilbert transform on the AD9786 is implemented as a 19-coefficient FIR. The coefficients are given in Table 36.

Table 36.

Coefficient	Integer Value
H(1)	-6
H(2)	0
H(3)	-17
H(4)	0
H(5)	-40
H(6)	0
H(7)	-91
H(8)	0
H(9)	-318
H(10)	0
H(11)	+318
H(12)	0
H(13)	+91
H(14)	0
H(15)	+40
H(16)	0
H(17)	+17
H(18)	0
H(19)	+6

The transfer function of an ideal Hilbert transform has a $+90^\circ$ phase shift for negative frequencies, and a -90° phase shift for positive frequencies. Because of the discontinuities that occur at 0 Hz and at $0.5 \times$ the sample rate, any real implementation of the Hilbert transform trades off bandwidth vs. ripple.

Figure 74 and Figure 75 show the gain of the Hilbert transform vs. frequency. Gain is essentially flat, with a pass-band ripple of 0.1 dB over the frequency range of $0.07 \times$ the sample rate to $0.43 \times$ the sample rate.

Figure 76 shows the phase response of the Hilbert transform implemented in the AD9786. The phase response for positive frequencies begins at -90° at 0 Hz, followed by a linear phase response (pure time delay) equal to nine filter taps (nine DACCLK cycles). For negative frequencies, the phase response at 0 Hz is $+90^\circ$, followed by a linear phase delay of nine filter taps. To compensate for the unwanted 9-cycle delay, an equal delay of nine taps is used in the AD9786 digital signal path opposite the Hilbert transform. This delay block is shown as Δt in the Functional Block Diagram (Figure 1).

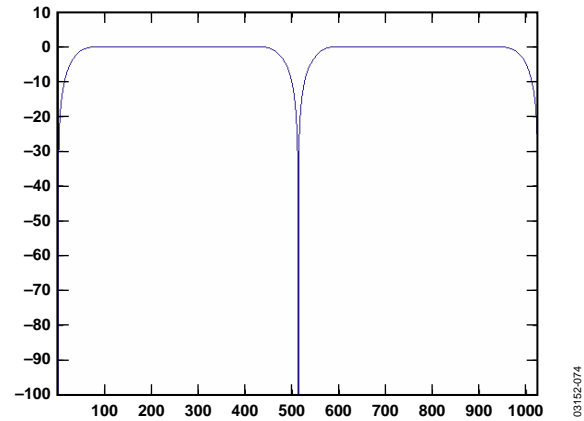

Figure 74. Hilbert Transform Gain

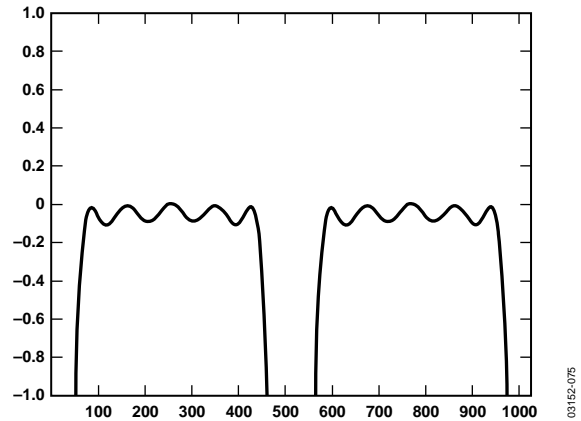

Figure 75. Hilbert Transform Ripple

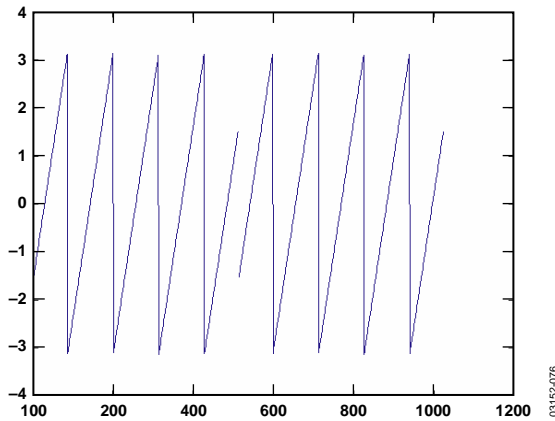

Figure 76. Phase Response of Hilbert Transform

Table 37. Dual Channel Complex Modulation Sideband Selection

Sideband	Mode
0	Upper IF sideband rejected
1	Lower IF sideband rejected

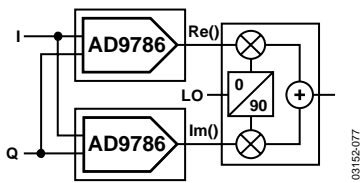

Figure 77. AD9786 Driving Quadrature Modulator

The AD9786 can be configured to drive a quadrature modulator, as in Figure 77. When two AD9786s are used with one AD9786 producing the real output, the second AD9786 produces the imaginary output. By configuring the AD9786 as a complex modulator coupled to a quadrature modulator, IF image rejection is possible. The quadrature modulator acts as the real part of a complex modulation, producing a double sideband spectrum at the local oscillator (LO) frequency with mirror symmetry about dc.

A baseband double sideband signal modulated to IF increases IF filter complexity and reduces power efficiency. If the baseband signal is complex, a single sideband IF modulation can be used, relaxing IF filter complexity and increasing power efficiency.

The AD9786 has the ability to place the baseband single sideband complex signal either above or below the IF frequency. Figure 78, Figure 79, and Figure 80 illustrate this.

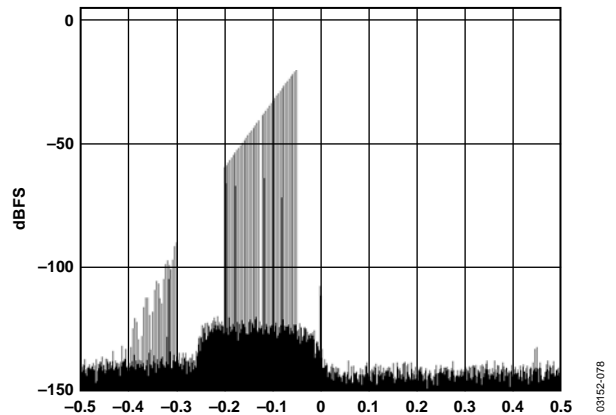

Figure 78. Upper IF Sideband Rejected

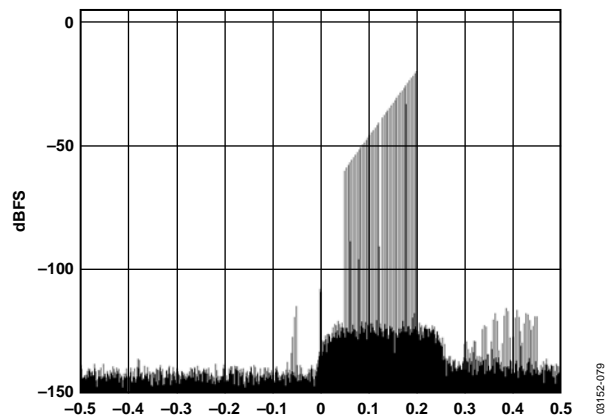

Figure 79. Lower IF Sideband Rejected

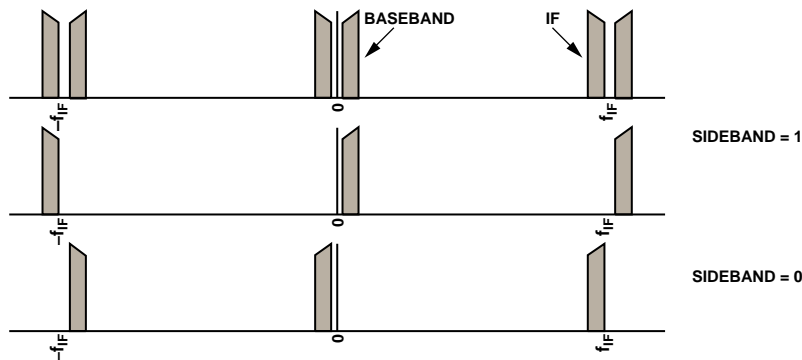

Figure 80. IF Quadrature Modulation of Real and Complex Baseband Signals

Master/Slave, Modulator/DATACLK Master Modes

In applications where two or more AD9786s are used to synthesize several digital data paths, it might be necessary to ensure that the digital inputs to each device are latched synchronously. In complex data processing applications, digital modulator phase alignment might be required between two AD9786s. To allow data synchronization and phase alignment, only one AD9786 should be configured as a master device, providing a reference clock for another slave-configured AD9786.

With synchronization enabled, a reference clock signal is generated on the DATACLK pin of the master. The DATACLK pins on the slave devices act as inputs for the reference clock generated by the master. The DATACLK pin on the master and all slaves must be directly connected. All master and slave devices must have the same clock source connected to their respective CLK+/CLK- pins.

When configured as a master, the reference clock generated can take one of two forms. In modulator master mode, the reference clock is a square wave with a period equal to 16 cycles of the DAC update clock. Internal to the AD9786 is a 16-state, finite state machine, running at the DAC update rate. This state machine generates all internal and external synchronization clocks and modulator phasings. The rising edge of the master reference clock is time aligned to state zero of the internal state machine. Slave devices use the master reference clock to synchronize data latching and align modulator phase by aligning state zero of the local state machine to the master.

The second master mode, DATACLK master mode, generates a reference clock that is at the channel data rate. In this mode, the slave devices align their internal channel data rate clock to the master. If modulator phase alignment is needed, a concurrent serial write to all slave devices is necessary. To achieve this, the CSB pin on all slaves must be connected together, and a group serial write to the MODADJ register bits must be performed. Following a successful serial write, the modulator coefficient alignment is updated upon the next rising edge of the internal state machine (see Figure 81). Modulator master mode does not need a concurrent serial write, because slaves lock to the master phase automatically.

In a slave device, the local channel data rate clock and the digital modulator clock are created from the internal state machine. The local channel data rate clock is used by the slave to latch digital input data. At high data rates, the delay inherent in the signal path from master to slave can cause the slave to lag the master when acquiring synchronization. To accommodate for this, an integer number of the DAC update clock cycles can be programmed into the slave device as an offset. The value in DATAADJ allows the local channel data rate clock in the slave device to advance by up to eight cycles of the DAC clock, or to be delayed by up to seven cycles (see Figure 82).

The digital modulator coefficients are updated at the DAC clock rate and decoded in sequential order from the state machine according to Figure 83. The MODADJ bits can be used to align a different coefficient to the finite state machine's zero state, as shown in Figure 84.

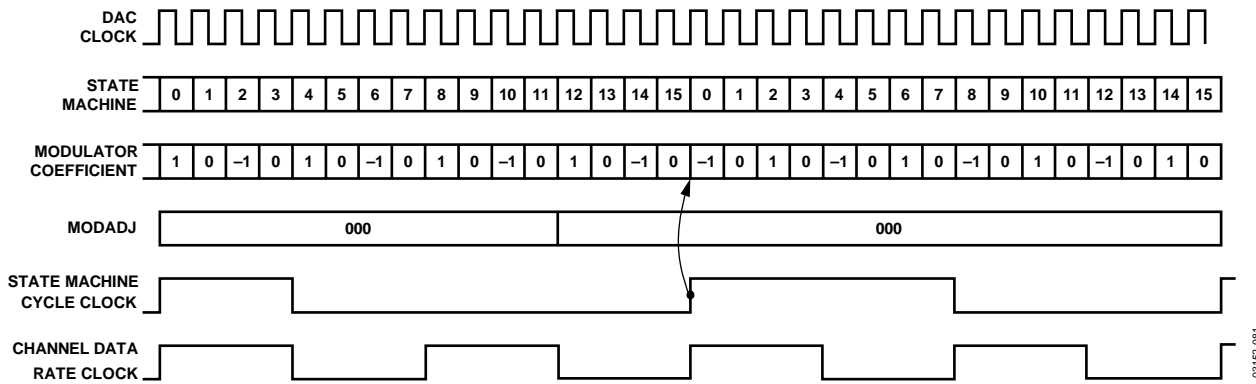

Figure 81. Synchronous Serial Modulator Phase Alignment

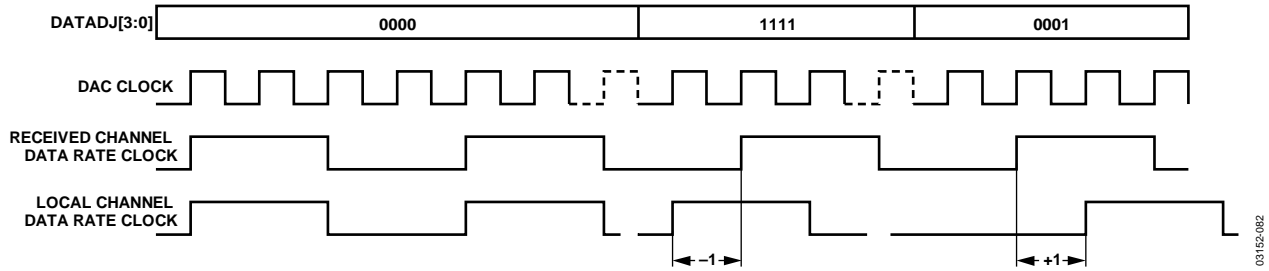

Figure 82. Local Channel Data Rate Clock Synchronized with Offset

STATE	0	1	2	3	4	5	6	7	8	9	10	11	12	13	14	15	
DECODE	1	0	$1/\sqrt{2}$	0	0	0	$-1/\sqrt{2}$	0	-1	0	$-1/\sqrt{2}$	0	0	0	$-1/\sqrt{2}$	0	
fs/8	0	→	1	→	2	→	3	→	4	→	5	→	6	→	7	→	
fs/4	0	→		1	→		2		→		3	→		4		→	
fs/2	0	→				1				→				2			

03152-083

Figure 83. Digital Modulator State Machine Decode

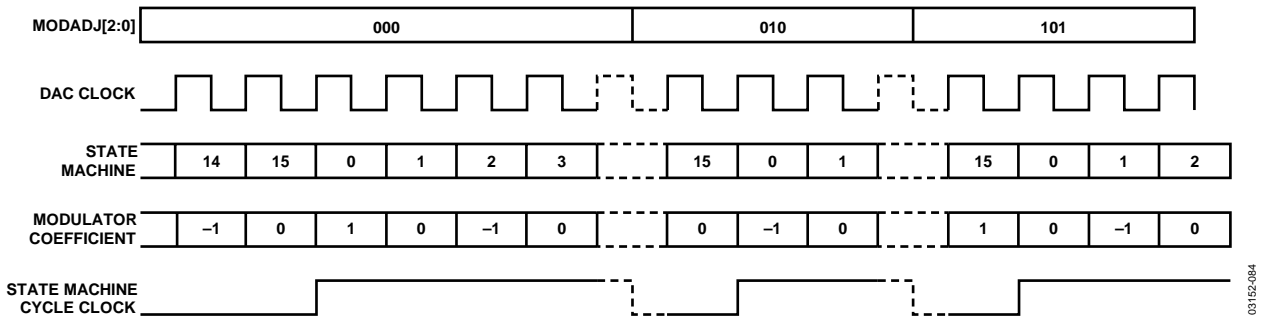

Figure 84. Local Modulator Coefficient Synchronized with Offset

OPERATING THE AD9786 REV. F EVALUATION BOARD

This section provides information to power up the board and verify correct operation; a description of more advanced modes of operation has been omitted.

POWER SUPPLIES

The AD9786 Rev. F evaluation board has five power supply connectors, labeled AVDD1, AVDD2, ACVDD/ADVDD, CLKVDD, and DVDD, whereas the AD9786 has seven power supply domains. To reconcile the power supply domains on the chip with the power supply connectors on the evaluation board, use Table 38.

Additionally, the DRVDD power supply on the AD9786 is used to supply power for the digital input bus. DRVDD should be run from 3.3 V. On the evaluation board, DRVDD is jumper-selectable by JP1, which is just to the left of the chip on the evaluation board. With the jumper set to the 3.3 V position, the DRVDD chip receives its power from VDD3IN.

PECL CLOCK DRIVER

The AD9786 system clock is driven from an external source via Connector S1. The AD9786 evaluation board includes an ON Semiconductor® MC100EPT22 PECL clock driver. In the factory, the evaluation board is set to use this PECL driver as a single-ended-to-differential clock receiver. The PECL driver can be set to run from 2.5 V from the CLKVDD power connector or 3.3 V from the VDD3IN power connector. This setting is done via Jumper JP2, situated next to the CLKVDD power connector, and by setting Input Bias Resistor R23 and Input Bias Resistor R4 on the evaluation board. The factory default is for the PECL driver to be powered from CLKVDD at 2.5 V (R23 = 90.9 Ω, R4 = 115 Ω). To operate the PECL driver with a 3.3 V supply, R23 must be replaced with a 115 Ω resistor; R4 must be replaced with a 90.9 Ω resistor; and the position of JP2 must be changed. The schematic of the PECL driver section of the evaluation board is shown in Figure 85. A low jitter sine wave should be used as the clock source. Care must be taken to ensure that the clock amplitude does not exceed the power supply rails for the PECL driver.

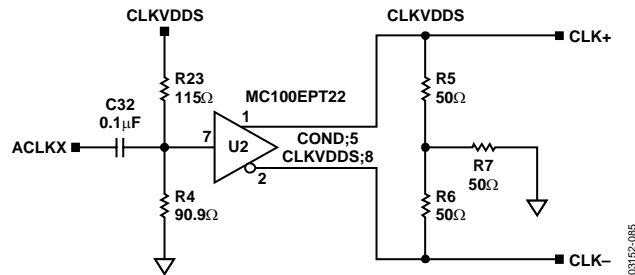

Figure 85. PECL Driver on AD9786 Rev. F Evaluation Board

Table 38. Power Supply Domains on AD9786 Rev. F Evaluation Board

Evaluation Board Label/PS Domain on Chip	Nominal Power Supply Voltage (V)	Description
DVDD	2.5	SPI port
CLKVDD	2.5	Clock circuitry
ACVDD/ADVDD	2.5	Analog circuitry containing clock and digital interface circuitry
AVDD2	3.3	Switching analog circuitry
AVDD1	3.3	Analog output circuitry

DATA INPUTS

Digital data inputs to the AD9786 are accessed on the evaluation board through Connector J1 and Connector J2. These are 40-pin, right-angle connectors that are intended to be used with standard ribbon cable connectors. The input level should be 3.3 V. The data format is selectable through Register 0x02, Bit 7 (DATAFMT). With this bit set to a default 0, the AD9786 assumes that the input data is in twos complement format. With this bit set to 1, data should be input in offset binary format.

When the evaluation board is first powered up and the clock and data are running, it is recommended that the proper operating current be verified. Press Reset Switch SW1 to ensure that the AD9786 is in default mode. The default mode for the AD9786 is for the interpolation set to 1×. The modulator is turned off in default mode. The nominal operating currents for the evaluation board in the power-up default mode are shown in Table 39.

Table 39. Nominal Operating Currents in Power-Up Default Mode

Evaluation Board Power Supply	Nominal Current @ Speed (mA)			
	50 MSPS	100 MSPS	150 MSPS	200 MSPS
DVDD	26	49	74	99
CLKVDD	78	83	87	92
ACVDD/ADVDD	1	4	6	8
AVDD1	30	30	30	30
AVDD2	27	27	27	27

Table 40. SPI Registers

Register	Bit 7	Bit 6	Bit 5	Bit 4	Bit 3	Bit 0
0x01	INTERP[1]	INTERP[0]				

SERIAL PORT

SW1 is a hard reset switch that sets the AD9786 to its default state. It should be used every time the AD9786 power supply is cycled, the clock is interrupted, or new data is to be written via the SPI port. Set the SPI software to read back data from the AD9786, and then verify that the expected values are read back when the software is run.

ANALOG OUTPUT

The analog output of the AD9786 is accessed via Connector S3. Once all settings are selected and the current levels and SPI port functionality are verified, the analog signal at S3 can be viewed. For most of the AD9786 applications, a spectrum analyzer is the preferred instrument to verify proper performance. A typical spectral plot is shown in Figure 86, with the AD9786 synthesizing a two-tone signal in the default mode with a 200 MSPS sample rate. A single-tone CW signal should provide output power of approximately +0.5 dBm to the spectrum analyzer.

If the spectrum does not look correct at this point, the data input might be violating setup and hold times with respect to the input clock. To correct this, the user should vary the input data timing. If this is not possible, SPI Register 0x02, Bit 4 (DCLKPOL), can be inverted. This bit controls the clock edge upon which the data is latched. If neither of these methods corrects the spectrum, it is unlikely that the issue is timing related. In this case, verify that all instructions have been followed correctly and that the SPI port readback indicates the correct values.

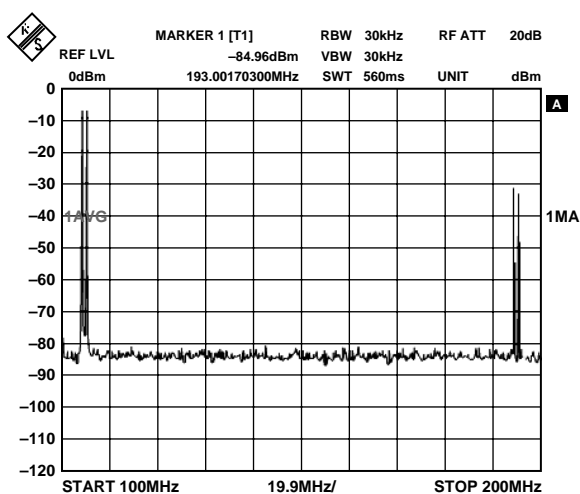
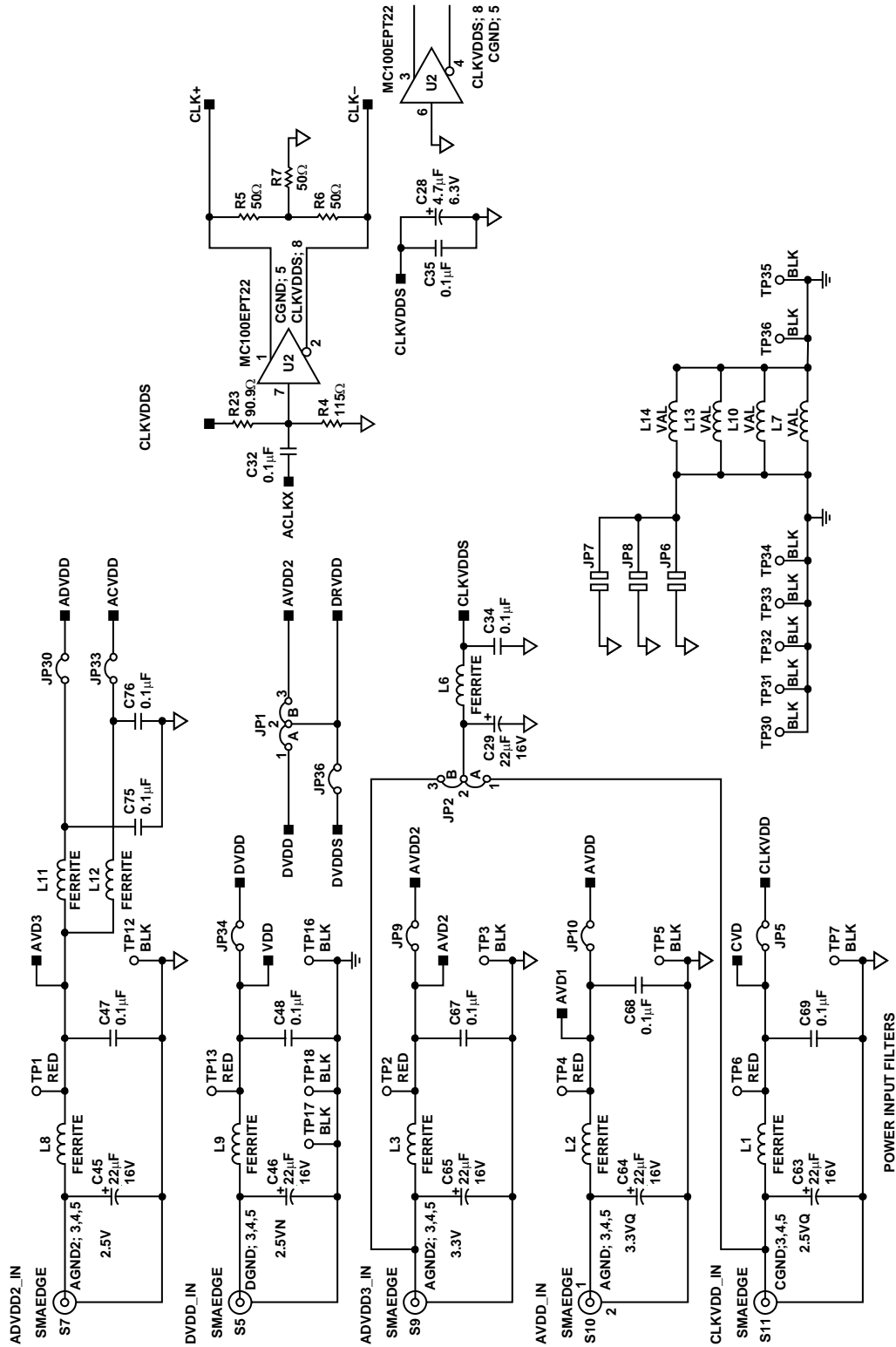

Figure 86. Typical Spectral Plot



03152-087

Figure 87. Power Supply Distribution, Rev. F Evaluation Board

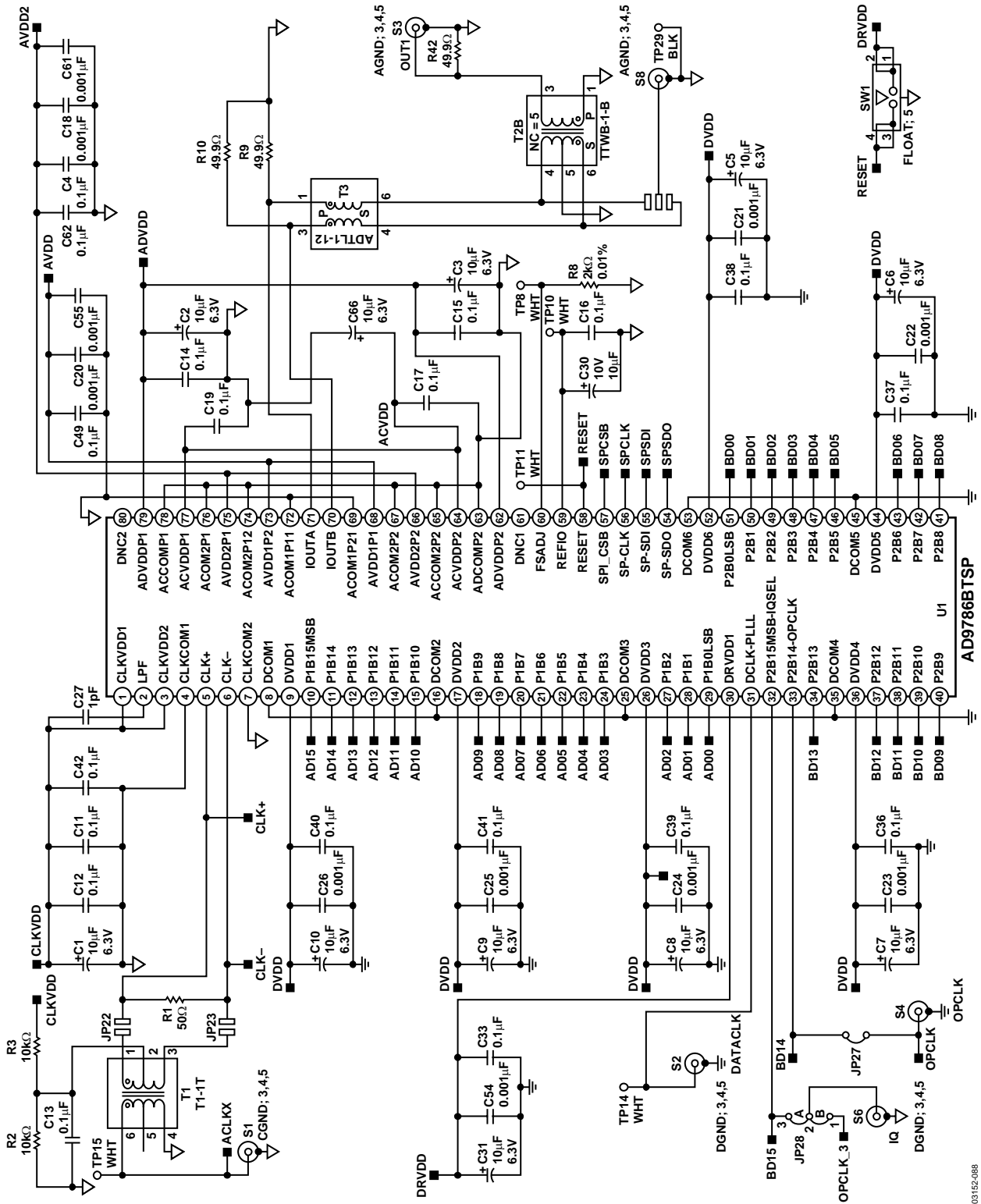

Figure 88. AD9786 Local Circuitry, Rev. F Evaluation Board

03152-088

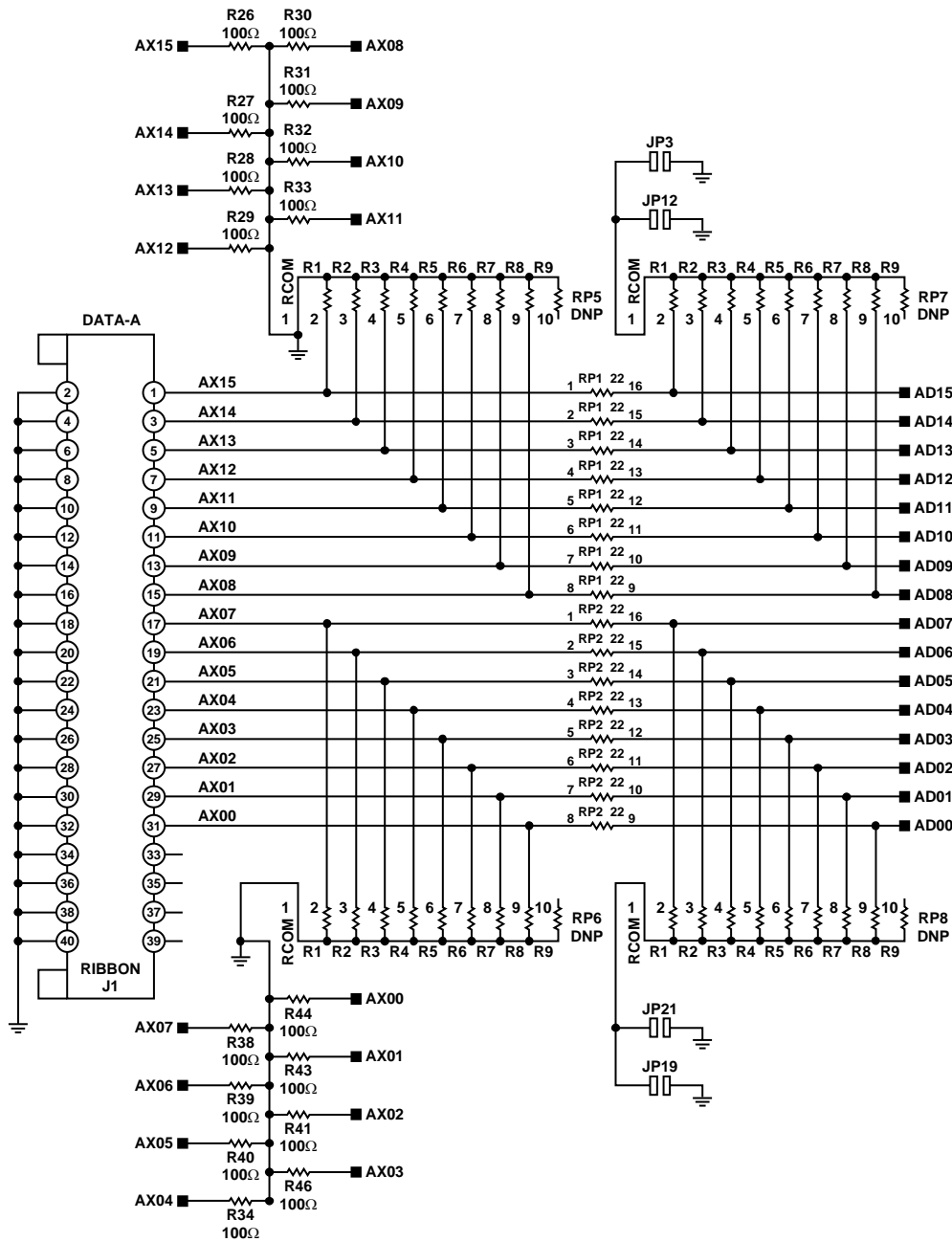

Figure 89. Digital Data Port A Input Terminations, Rev. F Evaluation Board

03152-089

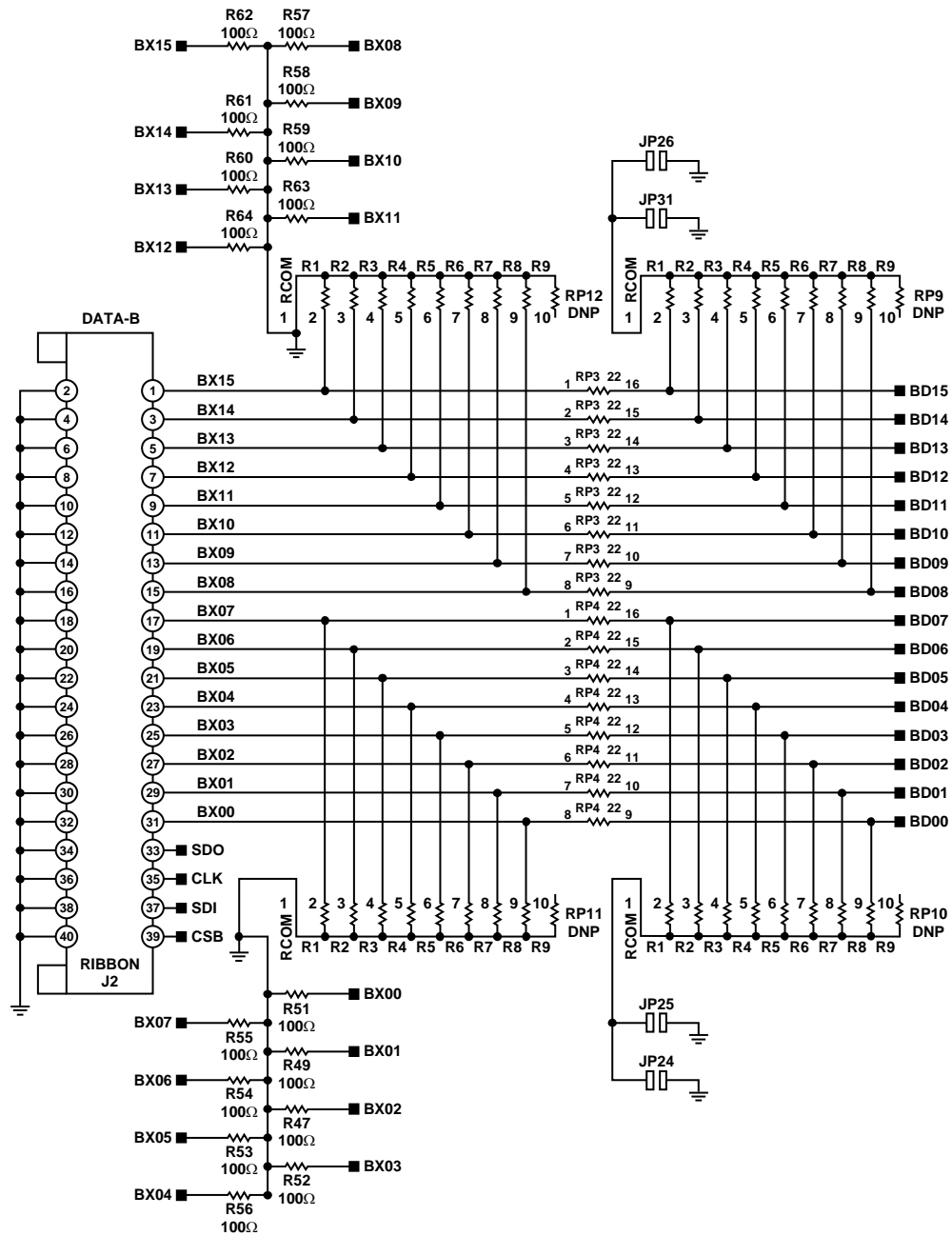

Figure 90. Digital Data Port B Input Terminations, Rev. F Evaluation Board

03152-090

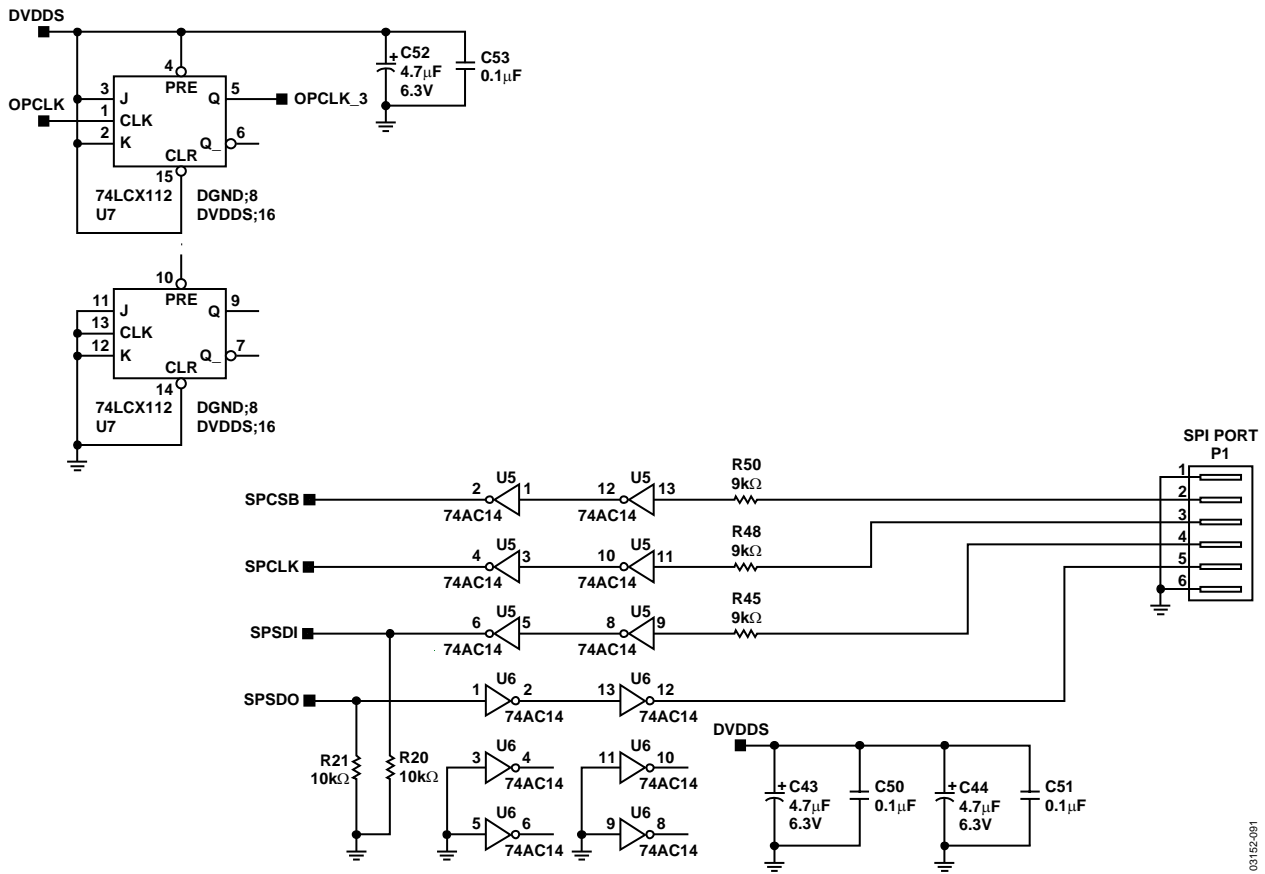

Figure 91. SPI and One-Port Clock Circuitry, Rev. F Evaluation Board

03152-081

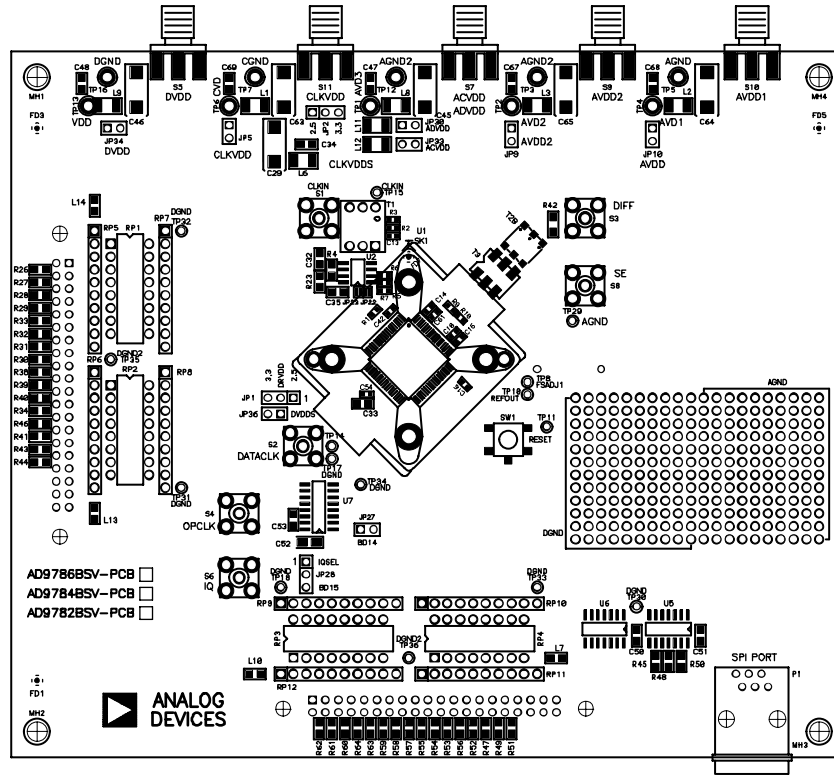

Figure 92. PCB Assembly, Primary Side, Rev. F Evaluation Board

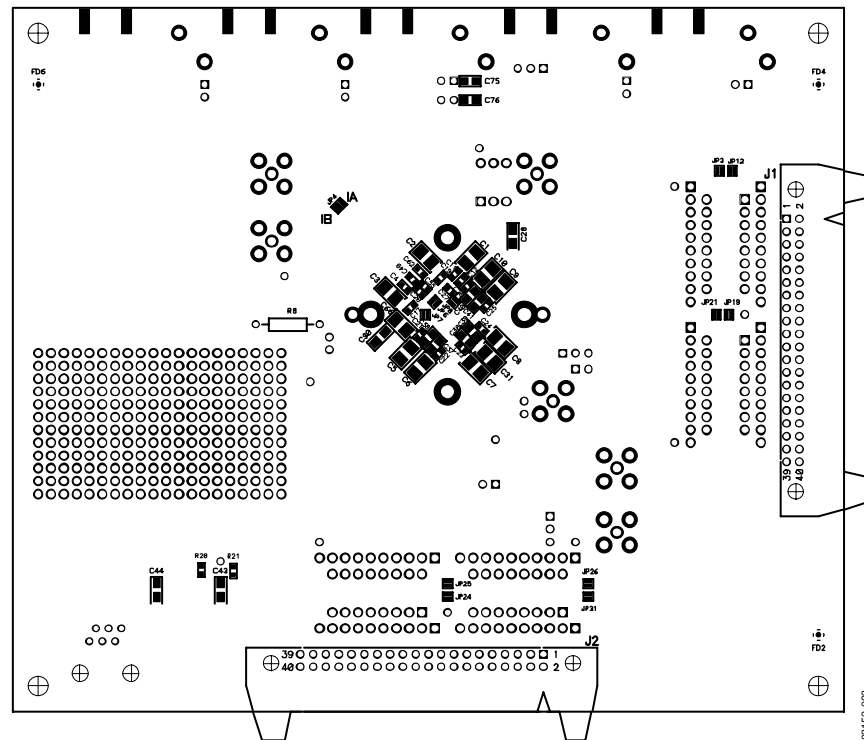

Figure 93. PCB Assembly, Secondary Side, Rev. F Evaluation Board

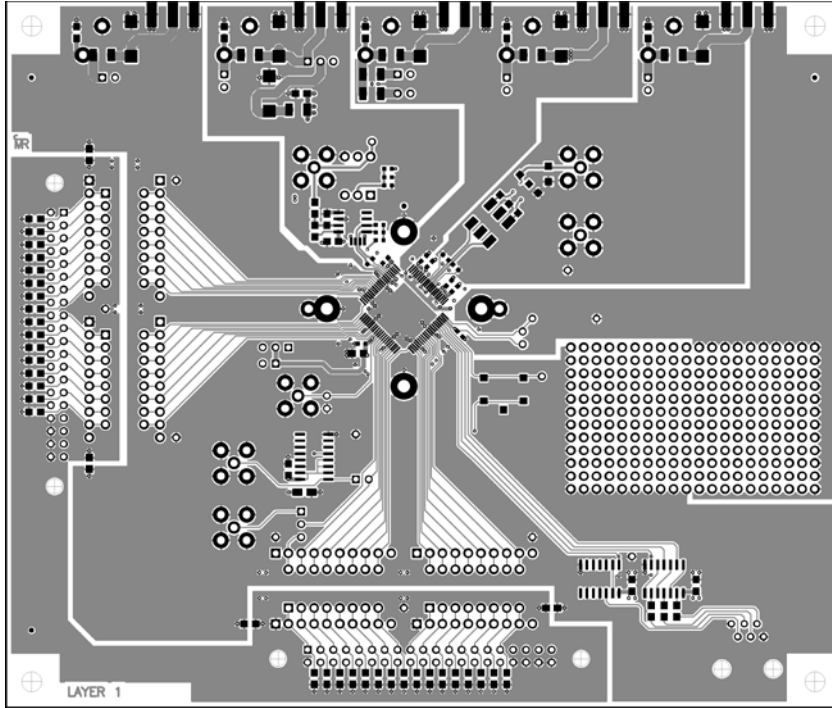

Figure 94. PCB Assembly, Layer 1 Metal, Rev. F Evaluation Board

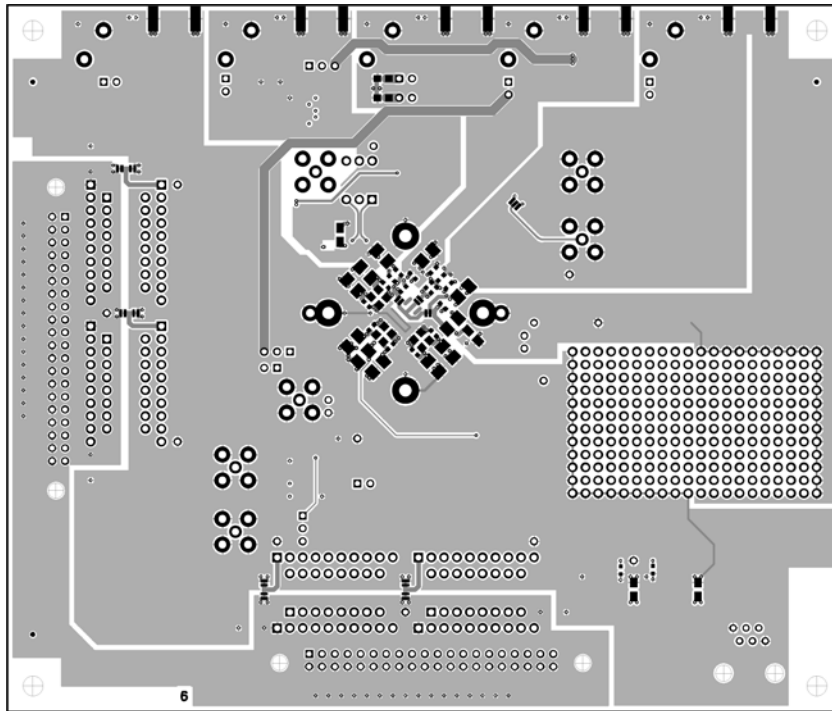

Figure 95. PCB Assembly, Layer 6 Metal, Rev. F Evaluation Board

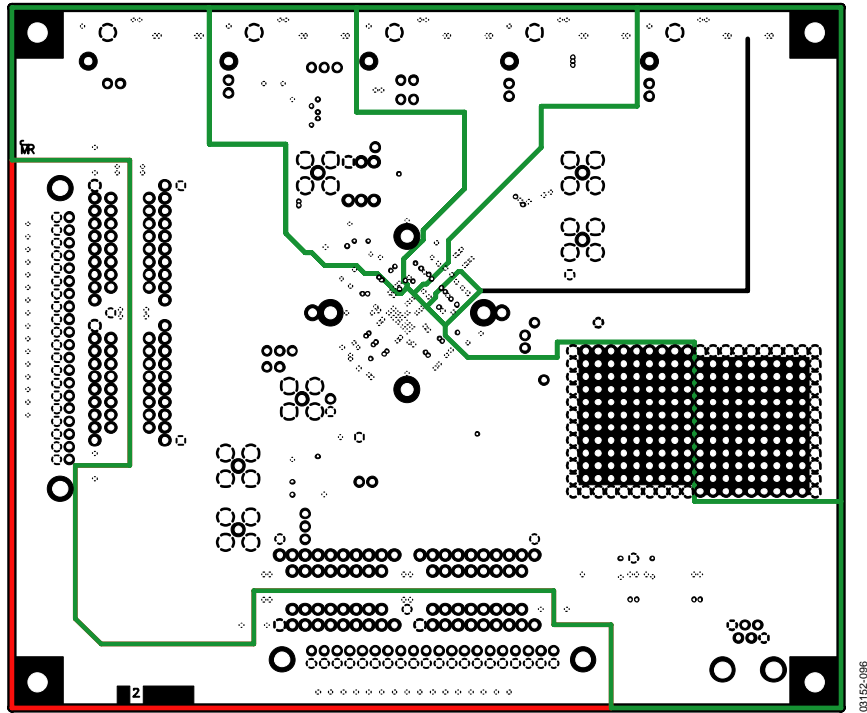

Figure 96. PCB Assembly, Layer 2 Metal (Ground Plane), Rev. F Evaluation Board

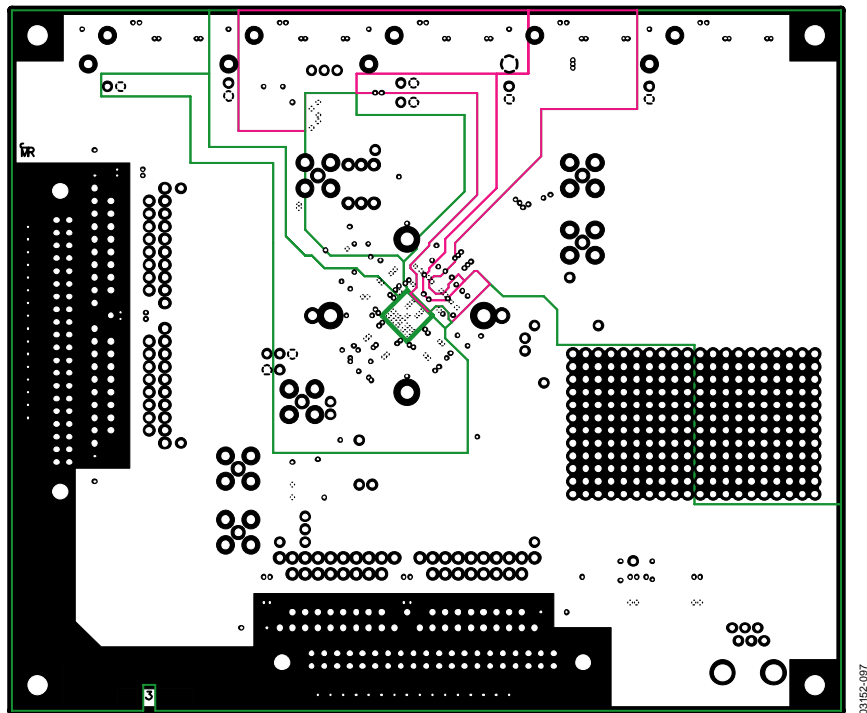

Figure 97. PCB Assembly, Layer 3 Metal (Power Plane), Rev. F Evaluation Board

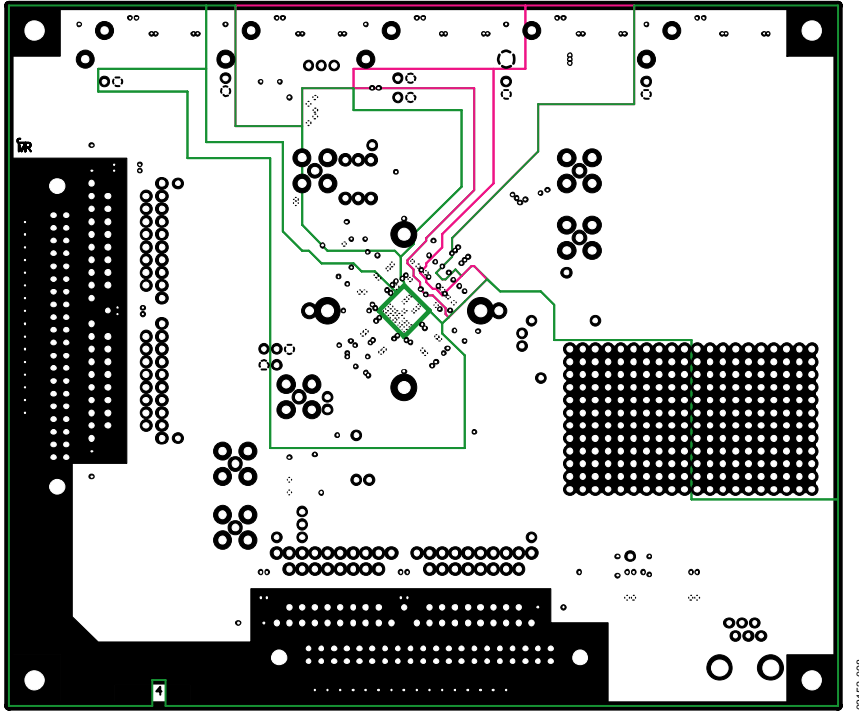

Figure 98. PCB Assembly, Layer 4 Metal (Power Plane), Rev. F Evaluation Board

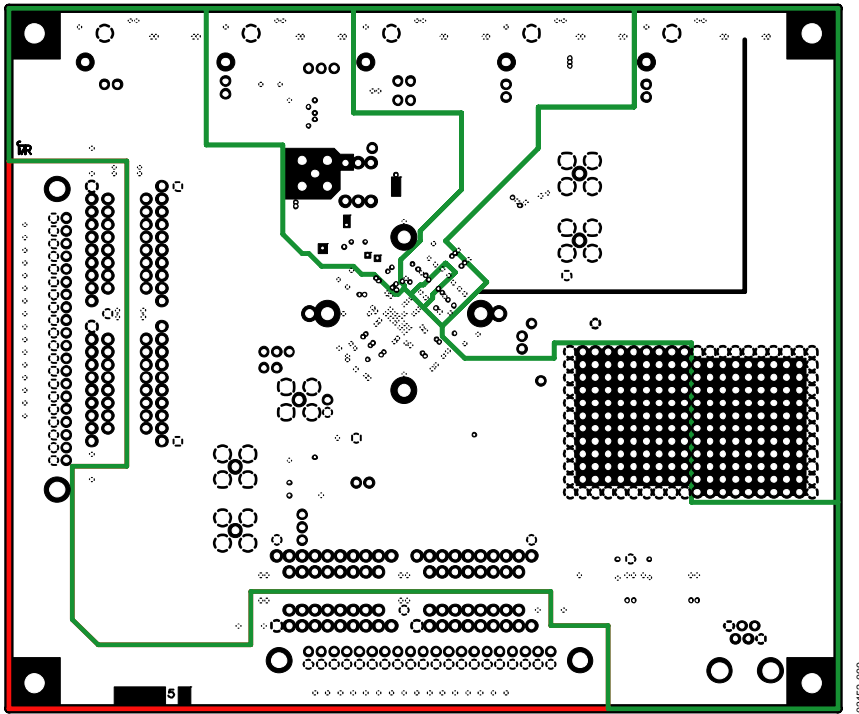
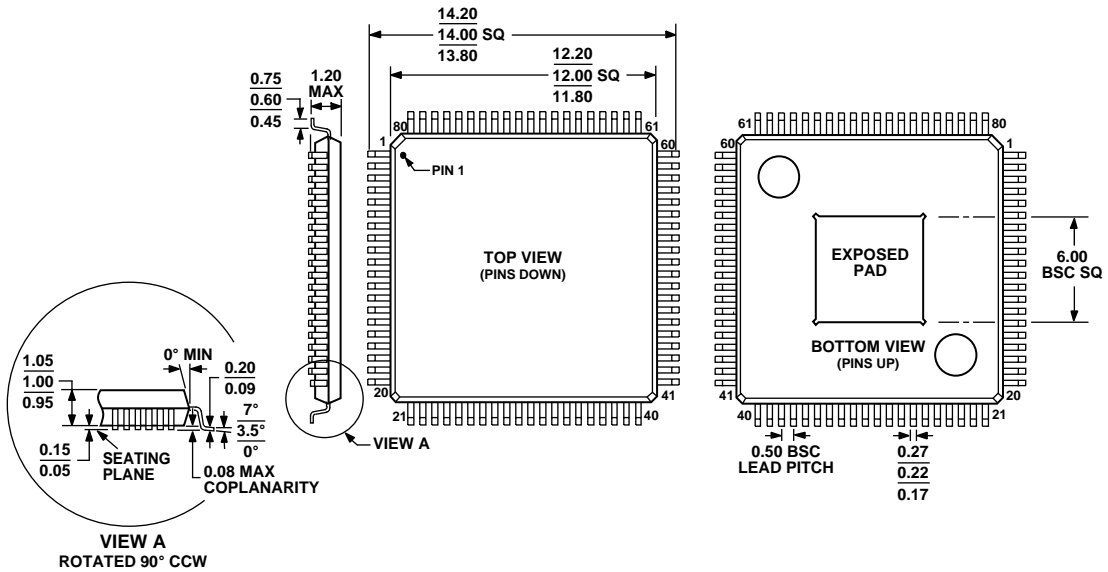

Figure 99. PCB Assembly, Layer 5 Metal (Ground Plane), Rev. F Evaluation Board

OUTLINE DIMENSIONS



COMPLIANT TO JEDEC STANDARDS MS-026-ADD-HD

Figure 100. 80-Lead Thin Quad Flat Package, Exposed Pad [TQFP_EP] (SV-80-1)
Dimensions shown in millimeters

ORDERING GUIDE

Model	Temperature Range	Package Description	Package Option
AD9786BSV	-40°C to +85°C	80-Lead TQFP_EP	SV-80-1
AD9786BSVRL	-40°C to +85°C	80-Lead TQFP_EP	SV-80-1
AD9786BSVZ ¹	-40°C to +85°C	80-Lead TQFP_EP	SV-80-1
AD9786BSVZRL ¹	-40°C to +85°C	80-Lead TQFP_EP	SV-80-1
AD9786-EB		Evaluation Board	

¹ Z = Pb-free part.

AD9786

NOTES

Mouser Electronics

Authorized Distributor

Click to View Pricing, Inventory, Delivery & Lifecycle Information:

[Analog Devices Inc.:](#)

[AD9786-EBZ](#) [AD9786BSVZ](#) [AD9786BSVZRL](#)