

**LMK04800 Family  
Low-Noise Clock Jitter Cleaner with Dual Loop PLLs**

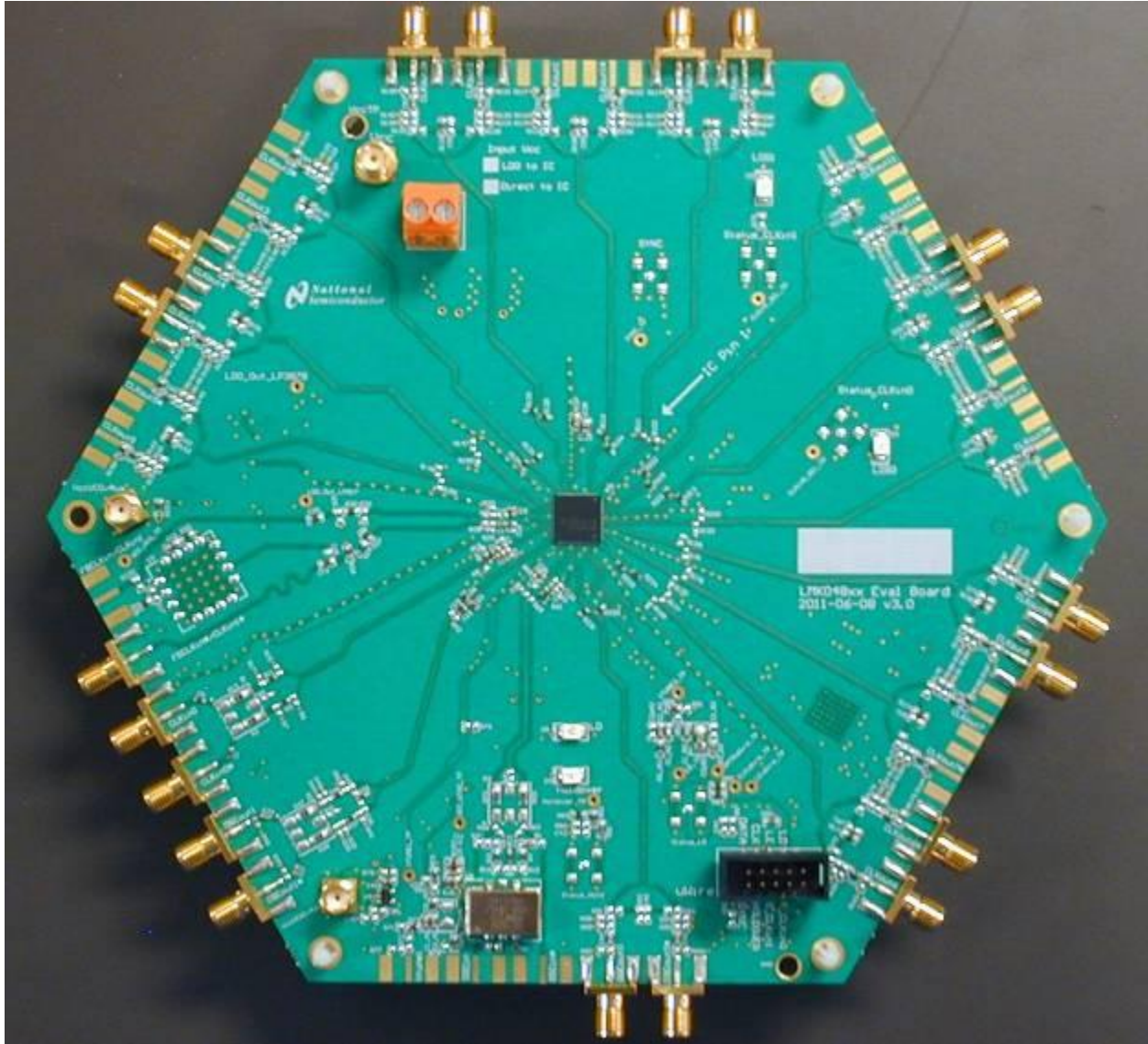

**LMK048xx Evaluation Board Operating Instructions**

National Semiconductor Corporation  
High Speed Products Division  
Precision Timing Devices  
January 2012



# Table of Contents

<b>TABLE OF CONTENTS.....</b>	<b>2</b>
<b>GENERAL DESCRIPTION.....</b>	<b>4</b>
EVALUATION BOARD KIT CONTENTS .....	4
AVAILABLE LMK048XX EVALUATION BOARDS.....	4
AVAILABLE LMK04800 FAMILY DEVICES .....	4
<b>QUICK START .....</b>	<b>5</b>
DEFAULT CODELOADER MODES FOR EVALUATION BOARDS.....	6
<b>EXAMPLE: USING CODELOADER TO PROGRAM THE LMK04808B .....</b>	<b>7</b>
1. START CODELOADER 4 APPLICATION.....	7
2. SELECT DEVICE .....	7
3. PROGRAM/LOAD DEVICE.....	8
4. RESTORING A DEFAULT MODE .....	8
5. VISUAL CONFIRMATION OF FREQUENCY LOCK.....	9
6. ENABLE CLOCK OUTPUTS.....	9
<b>PLL LOOP FILTERS AND LOOP PARAMETERS.....</b>	<b>11</b>
PLL 1 LOOP FILTER .....	11
122.88 MHz VCXO PLL.....	11
PLL2 LOOP FILTER .....	12
Integrated VCO PLL .....	12
<b>EVALUATION BOARD INPUTS AND OUTPUTS.....</b>	<b>13</b>
<b>RECOMMENDED TEST EQUIPMENT.....</b>	<b>21</b>
<b>PROGRAMMING 0-DELAY MODE IN CODELOADER .....</b>	<b>22</b>
OVERVIEW.....	22
DUAL LOOP 0-DELAY MODE EXAMPLES .....	22
Programming Steps.....	22
Details .....	22
SINGLE LOOP 0-DELAY MODE EXAMPLES .....	24
Programming Steps.....	24
Details .....	24
<b>APPENDIX A: CODELOADER USAGE.....</b>	<b>26</b>
PORT SETUP TAB .....	26
CLOCK OUTPUTS TAB .....	27
PLL1 TAB.....	29
Setting the PLL1 VCO Frequency and PLL2 Reference Frequency.....	30
PLL2 TAB.....	31
BITS/PINS TAB .....	32
REGISTERS TAB.....	37
<b>APPENDIX B: TYPICAL PHASE NOISE PERFORMANCE PLOTS.....</b>	<b>38</b>
PLL1.....	38
122.88 MHz VCXO Phase Noise.....	38
Clock Output Measurement Technique.....	39
Buffered OSCout Phase Noise.....	39



CLOCK OUTPUTS (CLKOUT) .....	40
<i>LMK04808B CLKout Phase Noise</i> .....	40
<i>LMK04808B OSCout Phase Noise</i> .....	42
<i>LMK04806B CLKout Phase Noise</i> .....	43
<i>LMK04806B OSCout Phase Noise</i> .....	45
<i>LMK04803B CLKout Phase Noise</i> .....	46
<i>LMK04803B OSCout Phase Noise</i> .....	48
<b>APPENDIX C: SCHEMATICS .....</b>	<b>49</b>
POWER SUPPLIES .....	49
LMK048xxB DEVICE WITH LOOP FILTER AND CRYSTAL CIRCUITS.....	50
REFERENCE INPUTS (CLKIN0 & CLKIN1), EXTERNAL VCXO (OSCIN) & VCO CIRCUITS, AND OSCOUT1 OUTPUT .....	51
CLOCK OUTPUTS (OSCOUT0, CLKOUT0 TO CLKOUT3) .....	52
CLOCK OUTPUTS (CLKOUT4 TO CLKOUT7) .....	53
CLOCK OUTPUTS (CLKOUT8 TO CLKOUT11) .....	54
UWIRE HEADER, LOGIC I/O PORTS AND STATUS LEADS.....	55
USB INTERFACE.....	56
<b>APPENDIX D: BILL OF MATERIALS .....</b>	<b>57</b>
<b>APPENDIX E: PCB LAYERS STACKUP.....</b>	<b>66</b>
<b>APPENDIX F: PCB LAYOUT .....</b>	<b>67</b>
LAYER #1 – TOP .....	67
LAYER #2 – RF GROUND PLANE (INVERTED).....	68
LAYER #3 – VCC PLANES .....	69
LAYER #4 – GROUND PLANE (INVERTED).....	70
LAYER # 5 – VCC PLANES 2.....	71
LAYER #6 – BOTTOM.....	72
LAYERS #1 AND 6 – TOP AND BOTTOM (COMPOSITE).....	73
<b>APPENDIX G: PROPERLY CONFIGURING LPT PORT .....</b>	<b>74</b>
LPT DRIVER LOADING.....	74
CORRECT LPT PORT/ADDRESS .....	74
CORRECT LPT MODE.....	75
<b>APPENDIX H: TROUBLESHOOTING INFORMATION .....</b>	<b>76</b>
1) CONFIRM COMMUNICATIONS .....	76
2) CONFIRM PLL1 OPERATION/LOCKING .....	76
3) CONFIRM PLL2 OPERATION/LOCKING .....	77

## General Description

The LMK048xx Evaluation Board simplifies evaluation of the LMK048xxB Low-Noise Clock Jitter Cleaner with Dual Loop PLLs. National Semiconductor’s *CodeLoader* software can be used to program the internal registers of the LMK048xxB device through the MICROWIRE™ interface. The *CodeLoader* software will run on a Windows 2000 or Windows XP PC and can be downloaded from <http://www.national.com/timing/software/>.

## Evaluation Board Kit Contents

The evaluation board kit includes:

- (1) LMK048xx Evaluation Board from Table 1
- (1) LMK04800 Family Quick Start Guide
  - Evaluation board instructions can be downloaded from [www.national.com](http://www.national.com).
- (1) CodeLoader uWire cable (LPT → uWire)

## Available LMK048xx Evaluation Boards

The LMK048xx Evaluation Board supports any of the four devices offered in the LMK04800 Family. All evaluation boards use the same PCB layout and bill-of-materials, except for the corresponding LMK0480xxB device affixed to the board. A commercial-quality VCXO is also mounted to the board to provide a known reference point for evaluating device performance and functionality.

**Table 1: Available Evaluation Board Configurations**

Evaluation Board ID	Device	PLL1 VCXO
LMK04803BEVAL	LMK04803B	122.88 MHz Crystek VCXO Model CVHD-950-122.880
LMK04805BEVAL	LMK04805B	
LMK04806BEVAL	LMK04806B	
LMK04808BEVAL	LMK04808B	

## Available LMK04800 Family Devices

**Table 2: LMK048xxB Devices**

Device	Reference Inputs	Buffered/ Divided OSCin Outputs	Programmable LVDS/LVPECL/ LVC MOS Outputs	VCO Frequency
LMK04803B	2	2	12	1840 to 2030 MHz
LMK04805B				2148 to 2370 MHz
LMK04806B				2370 to 2600 MHz
LMK04808B				2750 to 3072 MHz

## Quick Start

Full evaluation board instructions are downloadable from the LMK048xxB device product folder at [www.national.com](http://www.national.com).

1. Connect a power supply voltage of **5 V** to the Vcc SMA connector. The onboard LP3878-ADJ LDO regulator will output a low-noise 3.3 V supply to operate the device.
2. Connect a reference clock from a signal source to the CLKin1 SMA port. Use **122.88 MHz** for default. The reference frequency depends on the device programming.
3. Connect the uWire header to a PC parallel port using the CodeLoader cable. A USB interface is also available (search for “USB2UWIRE-IFACE” at [www.national.com](http://www.national.com)).
4. Program the device with a default mode using CodeLoader. Ctrl+L must be pressed at least once to load all registers. Alternatively click menu “Keyboard Controls” → “Load Device”. CodeLoader can be downloaded from [www.national.com/timing/software/](http://www.national.com/timing/software/).
5. Measurements may be made on an active output clock port via its SMA connector.

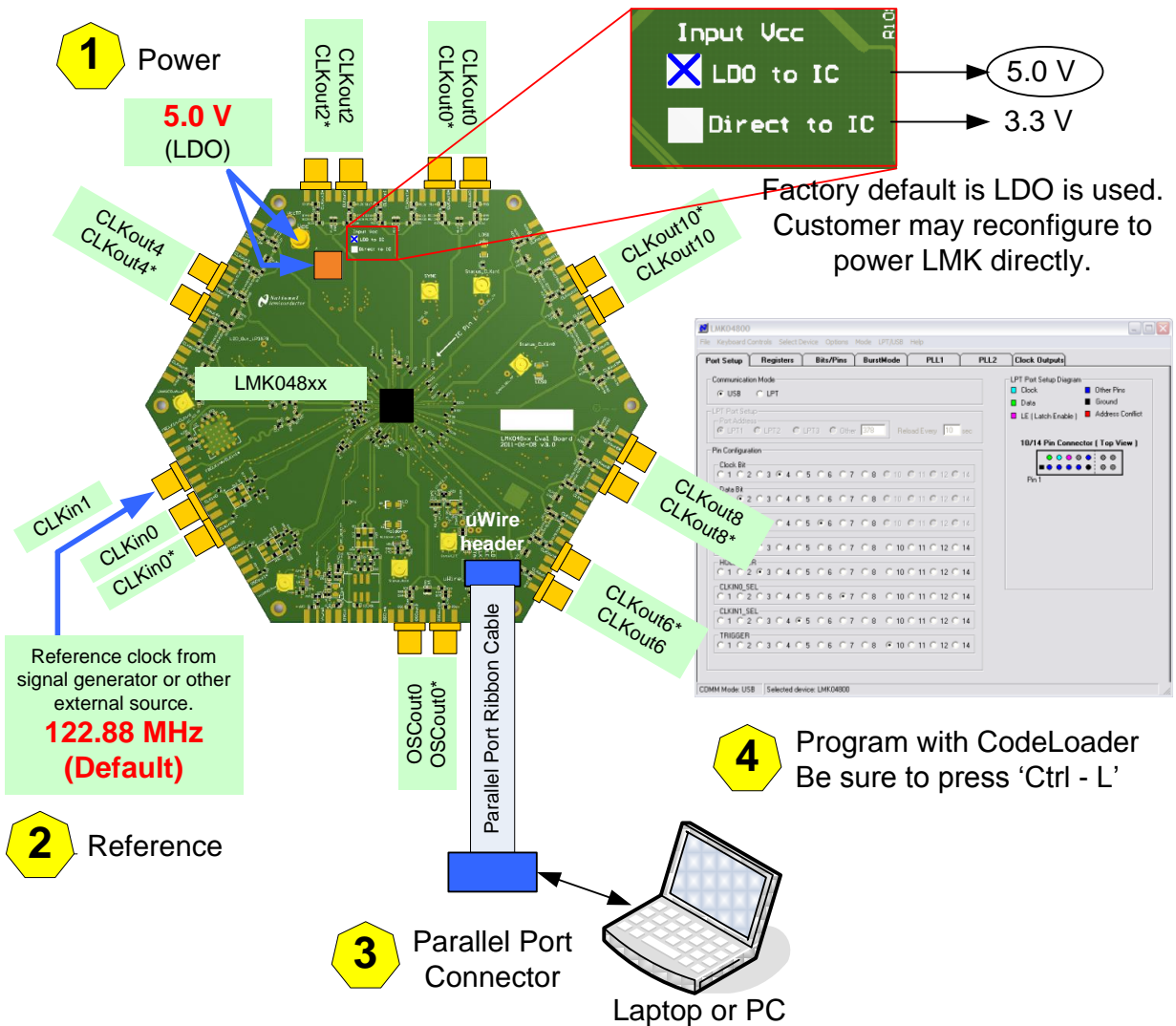

Figure 1: Quick Start Diagram

## Default CodeLoader Modes for Evaluation Boards

CodeLoader saves the state of the selected LMK048xxB device when exiting the software. To ensure a common starting point, the following modes listed in Table 3 may be restored by clicking “Mode” and selecting the appropriate device configuration, as shown in Figure 2 in the case of the LMK04808B device. Similar default modes are available for each LMK048xxB device in CodeLoader. Choose a mode with CLKin0 for differential clock signal or CLKin1 for a single ended signal.

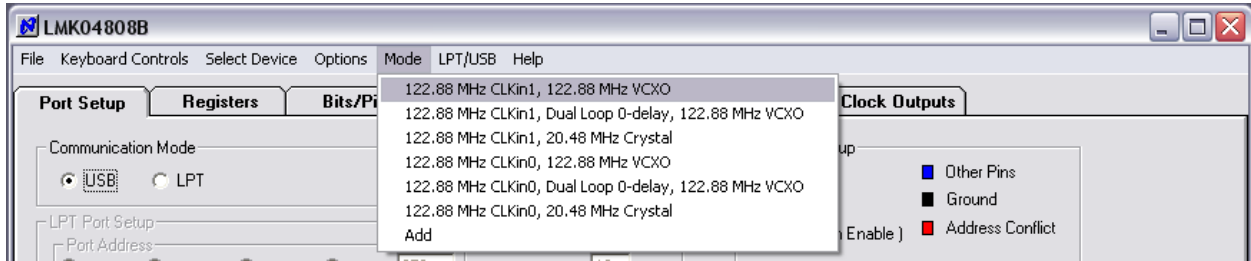

Figure 2: Selecting a Default Mode for the LMK04808 Device

After restoring a default mode, press Ctrl+L to program the device. The default modes also disable certain outputs, so make sure to enable the output under test to make measurements.

Table 3: Default CodeLoader Modes for LMK04808

Default CodeLoader Mode	Device Mode	CLKin Frequency	OSCin Frequency
122.88 MHz CLKin1, 122.88 MHz VCXO	Dual PLL, Internal VCO	122.88 MHz	122.88 MHz
122.88 MHz CLKin1, Dual Loop 0-delay, 122.88 MHz VCXO	Dual PLL, Internal VCO, 0-Delay with Internal Feedback	122.88 MHz	122.88 MHz
122.88 MHz CLKin1, 122.88 MHz VCXO	Dual PLL, Internal VCO, PLL2 Crystal Oscillator Enabled	122.88 MHz	20.48 MHz
122.88 MHz CLKin1, 122.88 MHz VCXO	Dual PLL, Internal VCO	122.88 MHz	122.88 MHz
122.88 MHz CLKin1, Dual Loop 0-delay, 122.88 MHz VCXO	Dual PLL, Internal VCO, 0-Delay with Internal Feedback	122.88 MHz	122.88 MHz
122.88 MHz CLKin1, 122.88 MHz VCXO	Dual PLL, Internal VCO, PLL2 Crystal Oscillator Enabled	122.88 MHz	20.48 MHz

The next section outlines step-by-step procedures for using the evaluation board with the LMK04808B. For boards with another part number, make sure to select the corresponding part number under the “Device” menu.

## Example: Using CodeLoader to Program the LMK04808B

The purpose of this section is to walk the user through using CodeLoader 4 to make some measurements with the LMK04808B device as an example. For more information on CodeLoader refer to Appendix A: CodeLoader Usage or the CodeLoader 4 instructions located at <http://www.national.com/timing/software/>.

Before proceeding, be sure to follow the Quick Start section above to ensure proper connections.

### 1. Start CodeLoader 4 Application

Click “Start” → “Programs” → “CodeLoader 4” → “CodeLoader 4”

The CodeLoader 4 program is installed by default to the CodeLoader 4 application group.

### 2. Select Device

Click “Select Device” → “Clock Conditioners” → “LMK04808B”

Once started CodeLoader 4 will load the last used device. To load a new device click “Select Device” from the menu bar, then select the subgroup and finally device to load. For this example, the LMK04808B is chosen. Selecting the device does cause the device to be programmed.

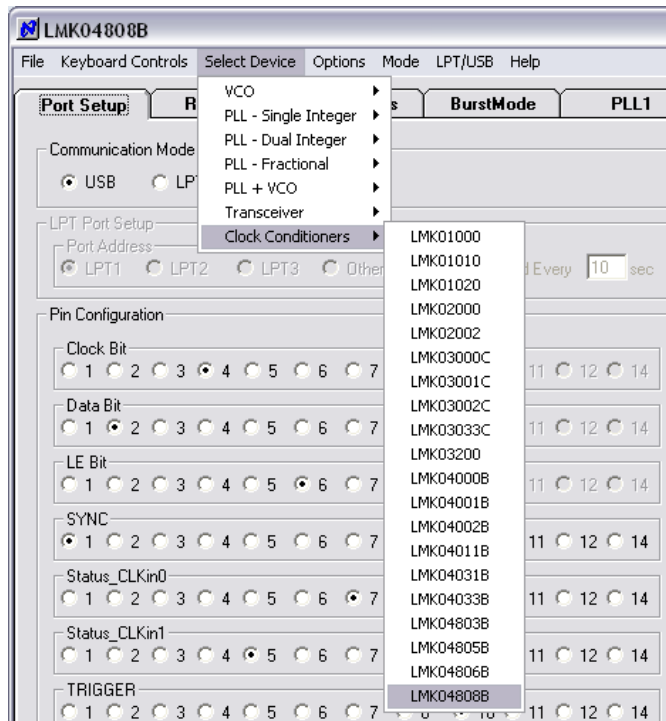

Figure 3 – Selecting the LMK04808B device

### 3. Program/Load Device

Assuming the Port Setup settings are correct, press the “Ctrl+L” shortcut or click “Keyboard Controls” → “Load Device” from the menu to program the device to the current state of the newly loaded LMK04800 file.

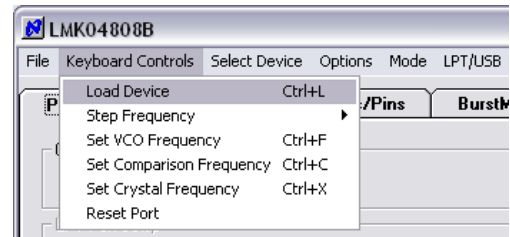

Figure 4 – Loading the Device

Once the device has been initially loaded, CodeLoader will automatically program changed registers so it is not necessary to re-load the device upon subsequent changes in the device configuration. It is possible to disable this functionality by ensuring there is no checkmark by the “Options” → “AutoReload with Changes.”

Because a default mode will be restored in the next step, this step isn’t really needed but included to emphasize the importance of pressing “Ctrl+L” to load the device at least once after starting CodeLoader, restoring a mode, or restoring a saved setup using the File menu.

See Appendix A: CodeLoader Usage or the CodeLoader 4 instructions located at <http://www.national.com/timing/software/> for more information on Port Setup. Appendix H: Troubleshooting Information contains information on troubleshooting communications.

### 4. Restoring a Default Mode

Click “Mode” → “LMK04808B, 122.88 MHz VCXO, 122.88 MHz CLKin1”; then press Ctrl+L.

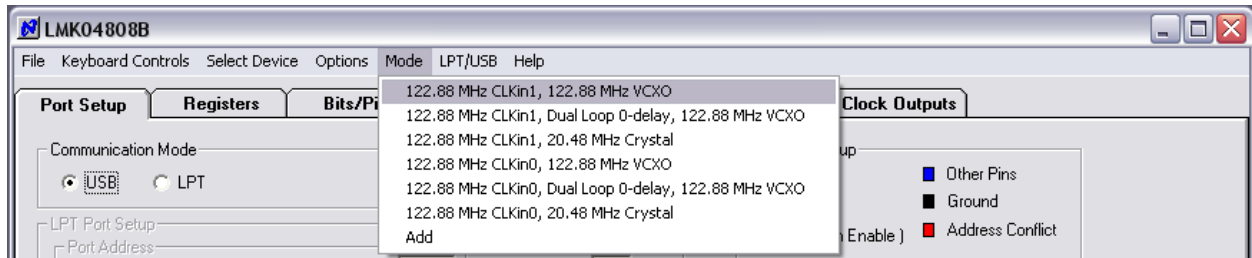

Figure 5: Setting the Default mode for LMK04808

For the purpose of this walkthrough, a default mode will be loaded to ensure a common starting point. This is important because when CodeLoader is closed, it remembers the last settings used for a particular device. Again, remember to press Ctrl+L as the first step after loading a default mode.



## 5. Visual Confirmation of Frequency Lock

After a default mode is restored and loaded, LED D5 should illuminate when PLL1 and PLL2 are locked to the reference clock applied to CLKIn1. This assumes LD\_MUX = PLL1/2 DLD and LD\_TYPE = Active High, which are the default settings.

## 6. Enable Clock Outputs

While the LMK048xxB offers programmable clock output buffer formats, the evaluation board is shipped with preconfigured output terminations to match the default buffer type for each output. Refer to the CLKout port description in the Evaluation Board Inputs and Outputs section.

To measure phase noise at one of the clock outputs, for example, CLKout0:

1. Click on the **Clock Outputs** tab,
2. Uncheck “Powerdown” in the Digital Delay box to enable the channel,
3. Set the following settings as needed:
  - a. Digital Delay value
  - b. Clock Divider value
  - c. Analog Delay select and Analog Delay value (if not “Bypassed”)
  - d. Clock Output type.

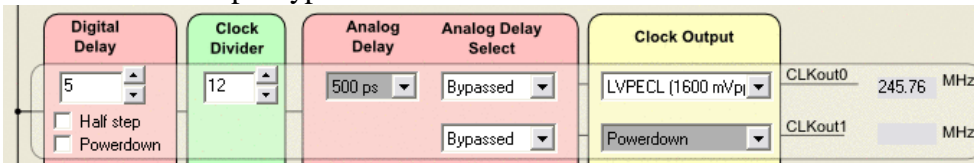

Figure 6: Setting Digital Delay, Clock Divider, Analog Delay, and Output Format for CLKout0

4. Depending on the configured output type, the clock output SMAs can be interfaced to a test instrument with a single-ended 50-ohm input as follows.
  - a. For LVDS:
    - i. A balun (like ADT2-1T) is recommended for differential-to-single-ended conversion.
  - b. For LVPECL:
    - i. A balun can be used, or
    - ii. One side of the LVPECL signal can be terminated with a 50-ohm load and the other side can be run single-ended to the instrument.
  - c. For LVCMOS:
    - i. There are two single-ended outputs, CLKoutX and CLKoutX\*, and each output can be set to Normal, Inverted, or Off. There are nine (9) combinations of LVCMOS modes in the Clock Output list.
    - ii. One side of the LVCMOS signal can be terminated with a 50-ohm load and the other side can be run single-ended to the instrument.
    - iii. A balun may also be used. Ensure CLKoutX and CLKoutX\* states are

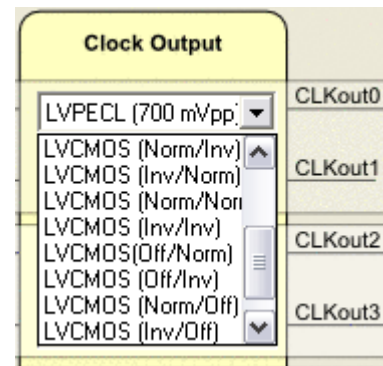

Figure 7: Setting LVCMOS modes



complementary to each other, i.e.: Norm/Inv or Inv/Norm.

5. The phase noise may be measured with a spectrum analyzer or signal source analyzer.

See Appendix B: Typical Phase Noise Performance Plots for phase noise plots of the clock outputs.

National's Clock Design Tool can be used to calculate divider values to achieve desired clock output frequencies. See: <http://www.national.com/timing/software/>.

## PLL Loop Filters and Loop Parameters

In jitter cleaning applications that use a cascaded or dual PLL architecture, the first PLL’s purpose is to substitute the phase noise of a low-noise oscillator (VCXO or crystal resonator) for the phase noise of a “dirty” reference clock. The first PLL is typically configured with a narrow loop bandwidth in order to minimize the impact of the reference clock phase noise. The reference clock consequently serves only as a frequency reference rather than a phase reference.

The loop filters on the LMK048xx evaluation board are setup using the approach above. The loop filter for PLL1 has been configured for a narrow loop bandwidth (< 100 Hz), while the loop filter of PLL2 has been configured for a wide loop bandwidth (> 100 kHz). The specific loop bandwidth values depend on the phase noise performance of the oscillator mounted on the board. The following tables contain the parameters for PLL1 and PLL2 for each oscillator option.

National’s Clock Design Tool can be used to optimize PLL phase noise/jitter for given specifications. See: <http://www.national.com/timing/software/>.

### PLL 1 Loop Filter

Table 4: PLL1 Loop Filter Parameters for Crystek 122.88 MHz VCXO

122.88 MHz VCXO PLL			
Phase Margin	49°	K $\phi$ (Charge Pump)	100 $\mu$ A
Loop Bandwidth	12 Hz	Phase Detector Freq	1.024 MHz
		VCO Gain	2.5 kHz/Volt
Reference Clock Frequency	122.88 MHz	Output Frequency	122.88 MHz (To PLL 2)
Loop Filter Components	C1_A1 = 100 nF	C2_A1 = 680 nF	R2_A1 = 39 k $\Omega$

**Note:** PLL Loop Bandwidth is a function of K $\phi$ , K $v_{co}$ , N as well as loop components. Changing K $\phi$  and N will change the loop bandwidth.



## PLL2 Loop Filter

**Table 5: PLL2 Loop Filter Parameters for LMK048xxB**

<b>Integrated VCO PLL</b>					
	<b>LMK04803B</b>	<b>LMK04805B</b>	<b>LMK04806B</b>	<b>LMK04808B</b>	
<b>C1_A2</b>	0.047				nF
<b>C2_A2</b>	3.9				nF
<b>C3 (internal)</b>	0				nF
<b>C4 (internal)</b>	0				nF
<b>R2_A2</b>	0.62				kΩ
<b>R3 (internal)</b>	0.2				kΩ
<b>R4 (internal)</b>	0.2				kΩ
<b>Charge Pump Current, <math>K\phi</math></b>	3.2				mA
<b>Phase Detector Frequency</b>	122.88				MHz
<b>Frequency</b>	1966.08	2211.84	2457.6	2949.12	MHz
<b>Kvco</b>	17.9	16.5	18.8	32.3	MHz/V
<b>N</b>	16	18	20	24	
<b>Phase Margin</b>	75	75	75	76	degrees
<b>Loop Bandwidth</b>	355	320	321	424	kHz

**Note:** PLL Loop Bandwidth is a function of  $K\phi$ , Kvco, N as well as loop components. Changing  $K\phi$  and N will change the loop bandwidth.



## Evaluation Board Inputs and Outputs

The following table contains descriptions of the inputs and outputs for the evaluation board. Unless otherwise noted, the connectors described can be assumed to be populated by default. Additionally, some applicable CodeLoader programming controls are noted for convenience. Refer to the [LMK04800 Family Datasheet](#) for complete register programming information.

**Table 6: Evaluation Board Inputs and Outputs**

Connector Name	Signal Type, Input/Output	Description																										
<p><u>Populated:</u> CLKout0, CLKout0*, CLKout2, CLKout2*, CLKout4, CLKout4*, CLKout6, CLKout6*, CLKout8, CLKout8*, CLKout10, CLKout10*</p> <p><u>Not Populated:</u> CLKout1, CLKout1*, CLKout3, CLKout3*, CLKout5, CLKout5*, CLKout7, CLKout7*, CLKout9, CLKout9*, CLKout11, CLKout11*</p>	<p>Analog, Output</p>	<p>Clock outputs with programmable output buffers.</p> <p>The output terminations by default on the evaluation board are shown below, and the output type selected by default in CodeLoader is indicated by an asterisk (*):</p> <table border="1" data-bbox="769 789 1425 1318"> <thead> <tr> <th>Clock output pair</th> <th>Default Board Termination</th> </tr> </thead> <tbody> <tr> <td>CLKout0</td> <td>LVPECL*</td> </tr> <tr> <td>CLKout1</td> <td>LVPECL</td> </tr> <tr> <td>CLKout2</td> <td>LVPECL*</td> </tr> <tr> <td>CLKout3</td> <td>LVPECL</td> </tr> <tr> <td>CLKout4</td> <td>LVDS* / LVCMOS</td> </tr> <tr> <td>CLKout5</td> <td>LVDS / LVCMOS</td> </tr> <tr> <td>CLKout6</td> <td>LVDS* / LVCMOS</td> </tr> <tr> <td>CLKout7</td> <td>LVDS / LVCMOS</td> </tr> <tr> <td>CLKout8</td> <td>LVDS* / LVCMOS</td> </tr> <tr> <td>CLKout9</td> <td>LVDS / LVCMOS</td> </tr> <tr> <td>CLKout10</td> <td>LVPECL*</td> </tr> <tr> <td>CLKout11</td> <td>LVPECL</td> </tr> </tbody> </table> <p>Each CLKout pair has a programmable LVDS, LVPECL, or LVCMOS buffer. The output buffer type can be selected in CodeLoader in the <b>Clock Outputs</b> tab via the CLKoutX_TYPE control.</p> <p>All clock outputs are AC-coupled to allow safe testing with RF test equipment.</p> <p>All LVPECL clock outputs are source-terminated using 240-ohm resistors.</p> <p>If an output pair is programmed to LVCMOS, each output can be independently configured (normal, inverted, or off/tri-state).</p>	Clock output pair	Default Board Termination	CLKout0	LVPECL*	CLKout1	LVPECL	CLKout2	LVPECL*	CLKout3	LVPECL	CLKout4	LVDS* / LVCMOS	CLKout5	LVDS / LVCMOS	CLKout6	LVDS* / LVCMOS	CLKout7	LVDS / LVCMOS	CLKout8	LVDS* / LVCMOS	CLKout9	LVDS / LVCMOS	CLKout10	LVPECL*	CLKout11	LVPECL
Clock output pair	Default Board Termination																											
CLKout0	LVPECL*																											
CLKout1	LVPECL																											
CLKout2	LVPECL*																											
CLKout3	LVPECL																											
CLKout4	LVDS* / LVCMOS																											
CLKout5	LVDS / LVCMOS																											
CLKout6	LVDS* / LVCMOS																											
CLKout7	LVDS / LVCMOS																											
CLKout8	LVDS* / LVCMOS																											
CLKout9	LVDS / LVCMOS																											
CLKout10	LVPECL*																											
CLKout11	LVPECL																											



Connector Name	Signal Type, Input/Output	Description						
<p><u>Populated:</u>                      OSCout0, OSCout0*,                      OSCout1, OSCout1*</p>	<p>Analog,                      Output</p>	<p>Buffered outputs of OSCin port.</p> <p>The output terminations on the evaluation board are shown below, the output type selected by default in CodeLoader is indicated by an asterisk (*):</p> <table border="1" data-bbox="769 468 1425 621"> <thead> <tr> <th data-bbox="769 468 1050 539">OSC output pair</th> <th data-bbox="1050 468 1425 539">Default Board Termination</th> </tr> </thead> <tbody> <tr> <td data-bbox="769 539 1050 579">OSCout0</td> <td data-bbox="1050 539 1425 579">LVDS* / LVCMOS</td> </tr> <tr> <td data-bbox="769 579 1050 621">OSCout1</td> <td data-bbox="1050 579 1425 621">LVPECL* (fixed)</td> </tr> </tbody> </table> <p>Only OSCout0 has a programmable LVDS, LVPECL, or LVCMOS output buffer. The OSCout0 buffer type can be selected in CodeLoader on the <b>Clock Outputs</b> tab via the OSCout0_TYPE control. OSCout1 has LVPECL buffer only but has programmable swing amplitude.</p> <p>Both OSCout pairs are AC-coupled to allow safe testing with RF test equipment.</p> <p>The OSCout1 output is source-terminated using 240-ohm resistors.</p> <p>If OSCout0 is programmed as LVCMOS, each output can be independently configured (normal, inverted, inverted, and off/tri-state).</p>	OSC output pair	Default Board Termination	OSCout0	LVDS* / LVCMOS	OSCout1	LVPECL* (fixed)
OSC output pair	Default Board Termination							
OSCout0	LVDS* / LVCMOS							
OSCout1	LVPECL* (fixed)							
<p>Vcc</p>	<p>Power,                      Input</p>	<p>Main power supply input for the evaluation board.</p> <p>A 3.9 V DC power source applied to this SMA will, by default, source the onboard LDO regulators that power the inner layer planes that supply the LMK048xxB and its auxiliary circuits (e.g. VCXO).</p> <p>The LMK048xxB contains internal voltage regulators for the VCO, PLL and other internal blocks. The clock outputs do not have an internal regulator, so a clean power supply with sufficient output current capability is required for optimal performance.</p> <p>On-board LDO regulators and 0 Ω resistor options provide flexibility to supply and route power to various devices. See schematics for more details.</p>						



Connector Name	Signal Type, Input/Output	Description
<u>Populated:</u> J1	Power, Input	Alternative power supply input for the evaluation board using two unshielded wires (Vcc and GND). Apply power to either Vcc SMA or J1, but not both.
<u>Populated:</u> VccVCO/Aux	Power, Input	Optional Vcc input to power the VCO circuit if separated voltage rails are needed. The VccVCO/Aux input can power these circuits directly or supply the on-board LDO regulators. 0 $\Omega$ resistor options provide flexibility to route power.
<u>Populated:</u> VccVCXO/Aux	Power, Input	Optional Vcc input to power the VCXO circuit if separated voltage rails are needed. The VccVCXO/Aux input can power these circuits directly or supply the on-board LDO regulators. 0 $\Omega$ resistor options provide flexibility to route power.



Connector Name	Signal Type, Input/Output	Description															
<p style="text-align: center;">Populated: CLKin0, CLKin0*, FBCLKin*/CLKin1*</p> <p style="text-align: center;">Not Populated: FBCLKin/CLKin1</p>	<p>Analog, Input</p>	<p>Reference Clock Inputs for PLL1 (CLKin0, 1). CLKin1 can alternatively be used as an External Feedback Clock Input (FBCLKin) in 0-delay mode or an RF Input (Fin) in External VCO mode.</p> <p><b>Reference Clock Inputs for PLL1 (CLKin0, 1)</b> FBCLKin/CLKin1* is configured by default for a single-ended reference clock input from a 50-ohm source. The non-driven input pin (FBCLKin/CLKin1) is connected to GND with a 0.1 uF. CLKin0/CLKin0* is configured by default for a differential reference clock input from a 50-ohm source.</p> <p>CLKin1* is the default reference clock input selected in CodeLoader. The clock input selection mode can be programmed on the <b>Bits/Pins</b> tab via the CLKin_Select_MODE control. Refer to the <a href="#">LMK04800 Family Datasheet</a> section “Input Clock Switching” for more information.</p> <p><b>AC coupled Input Clock Swing Levels</b></p> <table border="1" data-bbox="756 1052 1440 1167"> <thead> <tr> <th>Input</th> <th>Mode</th> <th>Min</th> <th>Max</th> <th>Units</th> </tr> </thead> <tbody> <tr> <td>Differential</td> <td>Bipolar or</td> <td>0.5</td> <td>3.1</td> <td>Vpp</td> </tr> <tr> <td>Single Ended</td> <td>CMOS</td> <td>0.25</td> <td>2.4</td> <td>Vpp</td> </tr> </tbody> </table> <p><b>External Feedback Input (FBCLKin) for 0-Delay</b> CLKin1 is shared for use with FBCLKin as an external feedback clock input to PLL1 for 0-delay mode. See section, Programming 0-Delay Mode in CodeLoader below, for more details on using 0-delay mode with the evaluation board and the evaluation board software.</p> <p><b>RF Input (Fin) for External VCO</b> CLKin1 is also shared for use with Fin as an RF input for external VCO mode using the onboard VCO footprint (U3) or add-on VCO board. To enable Dual PLL mode with External VCO, the following registers must be properly configured in CodeLoader:</p> <ul style="list-style-type: none"> <li>• MODE = (3) Dual PLL, Ext VCO (Fin), (5) Dual PLL, Ext VCO, 0-Delay, (11) PLL2, Ext VCO (Fin)</li> </ul>	Input	Mode	Min	Max	Units	Differential	Bipolar or	0.5	3.1	Vpp	Single Ended	CMOS	0.25	2.4	Vpp
Input	Mode	Min	Max	Units													
Differential	Bipolar or	0.5	3.1	Vpp													
Single Ended	CMOS	0.25	2.4	Vpp													





Connector Name	Signal Type, Input/Output	Description
<p><u>Not populated:</u> OSCin, OSCin*</p>	<p>Analog, Input</p>	<p>Feedback VCXO clock input to PLL1 and Reference clock input to PLL2.</p> <p>By default, these SMAs are not connected to the traces going to the OSCin/OSCin* pins of the LMK048xxB. Instead, the single-ended output of the onboard VCXO (U2) drives the OSCin* input of the device and the OSCin input of the device is connected to GND with 0.1 uF.</p> <p>A VCXO add-on board may be optionally attached via these SMA connectors with minor modification to the components going to the OSCin/OSCin* pins of device. This is useful if the VCXO footprint does not accommodate the desired VCXO device.</p> <p>A single-ended or differential signal may be used to drive the OSCin/OSCin* pins and must be AC coupled. If operated in single-ended mode, the unused input must be connected to GND with 0.1 uF.</p> <p>Refer to the <a href="#">LMK04800 Family Datasheet</a> section “Electrical Characteristics” for PLL2 Reference Input (OSCin) specifications.</p>
<p><u>Test point:</u> VTUNE1_TP</p> <p><u>Not populated:</u> Vtune1</p>	<p>Analog, Output</p>	<p>Tuning voltage output from the loop filter for PLL1.</p> <p>If a VCXO add-on board is used, this tuning voltage can be connected to the voltage control pin of the external VCXO when this SMA connector is installed and connected through R72 by the user.</p>
<p><u>Test point:</u> VTUNE2_TP</p>	<p>Analog, Output</p>	<p>Tuning voltage output from the loop filter for PLL2.</p>
<p><u>Populated:</u> uWire</p> <p><u>Test points:</u> DATAuWire_TP CLKuWIRE_TP LEuWIRE_TP</p>	<p>CMOS, Input/Output</p>	<p>10-pin header for uWire programming interface and programmable logic I/O pins for the LMK048xxB.</p> <p>The uWire interface includes CLKuWire, DATAuWire, and LEuWire signals.</p> <p>The programmable logic I/O signals accessible through this header include: SYNC, Status_Holdover, Status_LD, Status_CLKin0, and Status_CLKin1. These logic I/O signals also have dedicated SMAs and test points.</p>



Connector Name	Signal Type, Input/Output	Description
<p><u>Test point:</u> LD_TP</p> <p><u>Not populated:</u> Status_LD</p>	<p>CMOS, Output</p>	<p>Programmable status output pin. By default, set to output the digital lock detect status signal for PLL1 and PLL2 combined.</p> <p>In the default CodeLoader modes, LED D5 will illuminate green when PLL lock is detected by the LMK048xxB (output is high) and turn off when lock is lost (output is low).</p> <p>The status output signal for the Status_LD pin can be selected on the <b>Bits/Pins</b> tab via the LD_MUX control.</p> <p>Refer to the <a href="#">LMK04800 Family Datasheet</a> section “Status Pins” and “Digital Lock Detect” for more information.</p> <p>Note: Before a high-frequency internal signal (e.g. PLL divider output signal) is selected by LD_MUX, it is suggested to first remove the 270 ohm resistor to prevent the LED from loading the output.</p>
<p><u>Test point:</u> Holdover_TP</p> <p><u>Not populated:</u> Status_Hold</p>	<p>CMOS, Output</p>	<p>Programmable status output pin. By default, set to the output holdover mode status signal.</p> <p>In the default CodeLoader mode, LED D8 will illuminate red when holdover mode is active (output is high) and turn off when holdover mode is not active (output is low).</p> <p>The status output signal for the Status_Holdover pin can be selected on the <b>Bits/Pins</b> tab via the HOLDOVER_MUX control.</p> <p>Refer to the <a href="#">LMK04800 Family Datasheet</a> section “Status Pins” and “Holdover Mode” for more information.</p> <p>Note: Before a high-frequency internal signal (e.g. PLL divider output signal) is selected by HOLDOVER_MUX, it is suggested to first remove the 270 ohm resistor to prevent the LED from loading the output.</p>



Connector Name	Signal Type, Input/Output	Description																											
<p>Test point: CLKin0_SEL_TP CLKin1_SEL_TP</p> <p>Not populated: Status_CLKin0, Status_CLKin1</p>	<p>CMOS, Input/Output</p>	<p>Programmable status I/O pins. By default, set as input pins for controlling input clock switching of CLKin0 and CLKin1.</p> <p>These inputs will not be functional because CLKin_Select_MODE is set to 0 (CLKin0 Manual) by default in the <b>Bits/Pins</b> tab in CodeLoader. To enable input clock switching, CLKin_Select_MODE must be 3 or 6 and Status_CLKinX_TYPE must be 0 to 3 (pin enabled as an input).</p> <p><b>Input Clock Switching – Pin Select Mode</b> When CLKin_SELECT_MODE is 3, the Status_CLKinX pins select which clock input is active as follows:</p> <table border="1" data-bbox="743 835 1453 1024"> <thead> <tr> <th>Status_CLKin1</th> <th>Status_CLKin0</th> <th>Active Clock</th> </tr> </thead> <tbody> <tr> <td>0</td> <td>0</td> <td>CLKin0</td> </tr> <tr> <td>0</td> <td>1</td> <td>CLKin1</td> </tr> <tr> <td>1</td> <td>0</td> <td>Reserved</td> </tr> <tr> <td>1</td> <td>1</td> <td>Holdover</td> </tr> </tbody> </table> <p><b>Input Clock Switching – Auto with Pin Select</b> When CLKin_SELECT_MODE is 6, the active clock is selected using the Status_CLKinX pins upon an input clock switch event as follows:</p> <table border="1" data-bbox="760 1213 1437 1402"> <thead> <tr> <th>Status_CLKin1</th> <th>Status_CLKin0</th> <th>Active Clock</th> </tr> </thead> <tbody> <tr> <td>X</td> <td>0</td> <td>CLKin0</td> </tr> <tr> <td>1</td> <td>0</td> <td>CLKin1</td> </tr> <tr> <td>0</td> <td>0</td> <td>Reserved</td> </tr> </tbody> </table> <p>Refer to the <a href="#">LMK04800 Family Datasheet</a> section “Input Clock Switching” for more information.</p> <p><b>Status Outputs</b> When Status_CLKinX_TYPE is 3 to 6 (pin enabled as an output), the status output signal for the corresponding Status_CLKinX pin can be programmed on the <b>Bits/Pins</b> tab via the Status_CLKinX_MUX control.</p> <p>Refer to the <a href="#">LMK04800 Family Datasheet</a> section “Status Pins” for more information.</p>	Status_CLKin1	Status_CLKin0	Active Clock	0	0	CLKin0	0	1	CLKin1	1	0	Reserved	1	1	Holdover	Status_CLKin1	Status_CLKin0	Active Clock	X	0	CLKin0	1	0	CLKin1	0	0	Reserved
Status_CLKin1	Status_CLKin0	Active Clock																											
0	0	CLKin0																											
0	1	CLKin1																											
1	0	Reserved																											
1	1	Holdover																											
Status_CLKin1	Status_CLKin0	Active Clock																											
X	0	CLKin0																											
1	0	CLKin1																											
0	0	Reserved																											



Connector Name	Signal Type, Input/Output	Description
<p><u>Test point:</u> SYNC_TP</p> <p><u>Not populated:</u> SYNC</p>	<p>CMOS, Input/Output</p>	<p>Programmable status I/O pin. By default, set as an input pin for synchronize the clock outputs with a fixed and known phase relationship between each clock output selected for SYNC. A SYNC event also causes the digital delay values to take effect.</p> <p>In the default CodeLoader mode, SYNC will asserted when the SYNC pin is low and the outputs to be synchronized will be held in a logic low state. When SYNC is unasserted, the clock outputs to be synchronized are activated and will be initially phase aligned with each other except for outputs programmed with different digital delay values.</p> <p>A SYNC event can also be programmed by toggling the SYNC_POL_INV bit in the <b>Bits/Pins</b> tab in CodeLoader.</p> <p>Refer to the <a href="#">LMK04800 Family Datasheet</a> section “Clock Output Synchronization” for more information.</p> <p><b>Status Output</b> When SYNC_MUX is 3 to 6 (pin enabled as output), a status signal for the SYNC pin can be selected on the <b>Bits/Pins</b> tab via the SYNC_MUX control.</p>



## Recommended Test Equipment

### **Power Supply**

The Power Supply should be a low noise power supply, particularly when the devices on the board are being directly powered (onboard LDO regulators bypassed).

### **Phase Noise / Spectrum Analyzer**

To measure phase noise and RMS jitter, an Agilent E5052 Signal Source Analyzer is recommended. An Agilent E4445A PSA Spectrum Analyzer with the Phase Noise option is also usable although the architecture of the E5052 is superior for phase noise measurements. At frequencies less than 100 MHz the local oscillator noise of the E4445A is too high and measurements will reflect the E4445A's internal local oscillator performance, not the device under test.

### **Oscilloscope**

To measure the output clocks for AC performance, such as rise time or fall time, propagation delay, or skew, it is suggested to use a real-time oscilloscope with at least 1 GHz analog input bandwidth (2.5+ GHz recommended) with 50 ohm inputs and 10+ Gsps sample rate. To evaluate clock synchronization or phase alignment between multiple clock outputs, it's recommended to use phase-matched, 50-ohm cables to minimize external sources of skew or other errors/distortion that may be introduced if using oscilloscope probes.



## Programming 0-Delay Mode in CodeLoader

### Overview

When enabling the 0-Delay mode the feedback path of the VCO is altered to include a clock output. See the datasheet for more details on 0-Delay functionality.

The current version of the CodeLoader software does not include this extra divider in the frequency calculations when in holdover mode. To successfully lock the LMK04800 device in a 0-Delay mode the user must program the device “manually” account for this divider. Programming “manually” means that the VCO frequency and therefore the clock output frequencies displayed by the CodeLoader software may be incorrect. For the LMK04800 device to lock properly the **divider values** must be programmed correctly. The frequencies displayed in the application are only for the benefit of the user and for proper automatic programming of the OSCin\_FREQ register which will not be affected by 0-Delay.

When using the device in Dual Loop mode vs. Single Loop mode different procedures are used to cause the device to lock when using the CodeLoader software. The following two sections describe the process for when the LMK04800 device is programmed for a Dual Loop mode and Single Loop mode respectively. Each section contains a brief introduction, the programming steps to execute to make the device lock, and finally a detailed section discussing the workaround and some example cases.

### Dual Loop 0-Delay Mode Examples

In Dual Loop 0-Delay Modes, MODE = 2 or MODE = 5, the feedback from the VCXO of PLL1 to the PLL1 N divider is broken and a clock output will drive the PLL1 N divider. This permits phase alignment between the clock output and the clock input (0-Delay). As such, the PLL1\_N and PLL1\_R divide values may need to be adjusted to permit the LMK04800 to lock.

### Programming Steps

1. Program a Dual Loop 0-Delay mode.
2. Enable the feedback mux. EN\_FEEDBACK\_MUX = 1.
3. Select clock output for feedback with the feedback mux. FEEDBACK\_MUX = User value.
4. Program the VCXO (VCO) frequency of PLL1 tab to the clock output frequency selected by the feedback mux.

If for any reason the CLKout frequency is less than the phase detector frequency, the PLL1 R divider must be increased so that the phase detector is at the same or lower value than the CLKout frequency.

### Details

When using the CodeLoader software in Dual Loop 0-Delay mode, programming the VCXO (VCO) frequency of the PLL1 tab to the frequency of the feedback output clock will re-program the PLL1 N divider to allow the LMK04800 will be able to lock. The PLL1 loop has been altered and actual VCXO no longer directly feeds into PLL1 N divider. The VCXO is only used

by the reference input of PLL2 now. The PLL2 reference frequency will remain at the VCXO frequency.

When the PLL1 VCXO frequency is different from the PLL2 reference frequency, a warning will be displayed on the clock outputs tab informing the user that PLL1 VCO and PLL2 reference frequency are mismatched and the one or more of the PLLs are out of lock. While there still could be an error in the divider values which may cause a non-locked PLL, this warning by itself may no longer be assumed true. It is up to the user to ensure the PLL dividers are programmed correctly.

To illustrate the proper programming of the LMK04800 device in dual loop 0-delay mode the following case examples are provided. Note that in one of the cases, the feedback frequency from the clock output matches the VCXO frequency and CodeLoader will display the proper frequency values.

Dual Loop 0-Delay (MODE=2 or 5) Case 1: For example the default configuration, 122.88 MHz CLK<sub>in</sub>, 122.88 MHz VCXO, of the LMK04808 has the following register programming.

	Case 1: Default Mode  No 0-Delay	Case2: Default 0-Delay Mode (CLKout8 = 122.88 MHz)	Case 3: Default 0-Delay Mode (Updated CLKout8 = 245.76 MHz)	Case 4: Default 0-Delay Mode (Updated CLKout8 = 61.44 MHz)
Actual PLL1 VCXO Frequency	122.88	122.88	122.88	122.88
Reported PLL1 VCXO Frequency	122.88	122.88	<b>61.44</b>	<b>245.76</b>
PLL1 N	120	120	60	240
Actual PLL2 VCO Frequency	2949.12 MHz	2949.12 MHz	2949.12 MHz	2949.12 MHz
Reported PLL2 VCO Frequency	2949.12 MHz	2949.12 MHz	2949.12 MHz	2949.12 MHz
PLL2_N	12	12	12	12
PLL2_P (Pre-N)	2	2	2	2
PLL2 VCO Divider	Bypassed	Bypassed	Bypassed	Bypassed
CLKout8 Divide	12	24	12	48
Actual CLKout8 Output Frequency	<b>245.76 MHz</b>	<b>122.88 MHz</b>	<b>245.76 MHz</b>	<b>61.44 MHz</b>
Reported CLKout8 Output Frequency	245.76 MHz	122.88 MHz	245.76 MHz	61.44 MHz



## Single Loop 0-Delay Mode Examples

In Single Loop 0-Delay Mode,  $MODE = 8$ , the feedback from the VCO of PLL2 to the PLL2\_P/PLL2\_N divider is broken and a feedback clock output will drive the PLL2\_N divider directly. This permits phase alignment between the clock output and the OSCin input (0-Delay). As such, the PLL2\_N, PLL2\_R, and PLL2\_N\_CAL divide values may need to be adjusted to permit the LMK04800 to lock.

### Programming Steps

1. Program the Single Loop 0-Delay mode.
2. Enable the feedback mux.  $EN\_FEEDBACK\_MUX = 1$ .
3. Select clock output for feedback with the feedback mux.  $FEEDBACK\_MUX = \text{User value}$ .
4. Program the VCO frequency of PLL2 tab to: The actual VCO frequency \* PLL2\_P (which is PLL2 PreN) / CLKout Divider.
  - Entered CodeLoader 4 VCO Frequency = Actual VCO Frequency \* PLL2\_P / CLKout Divider.
5. Updated the PLL2\_N\_CAL register on the Bits/Pins tab to the N value when in non-0-Delay mode.
6. Press Ctrl-L to cause all registers to be programmed.
  - The reason is to cause the programming of register R30 to start the VCO calibration routine now that the proper PLL2\_N\_CAL value is programmed.
  - PLL2\_N\_CAL value is automatically updated when a new VCO frequency is entered and the PLL2\_N value is calculated. In this case the VCO frequency entered is wrong and the PLL2\_N\_CAL value will be incorrect.

If for any reason the CLKout frequency is less than the phase detector frequency, the PLL2\_R divider must be increased so that the phase detector is at the same or lower value than the CLKout frequency.

### Details

The 0-Delay mode for Single Loop mode is more complicated to program than for Dual Loop mode in part because of the PLL2\_N\_CAL register. When performing the VCO calibration the device uses PLL2\_N\_CAL for in non-0-Delay mode. Once the VCO is calibrated the device enters 0-Delay mode. For more information on the PLL programming equations, refer to PLL PROGRAMMING in the applications section of the datasheet.

In Table 7 case 1 illustrates the register programming when not using 0-Delay.

Case 2 shows 0-Delay with a clock out divider of 2. Since  $PLL2\_P = 2$ , this substitution of which circuit is performing the divide by two results in no impact on the software. All the values display correctly.

Case 3 shows 0-Delay mode with a CLKout divider not equal to the PLL2\_P value. So the proper frequency to program in the VCO to lock the VCO to 2949.12 MHz will be 491.52 MHz. This is calculated by Actual VCO Frequency \* PLL2\_P / CLKoutX\_Y\_DIV.



Case 4 shows 0-Delay mode with CLKout divider not equal to the PLL2\_P value; however the CLKout frequency will be less than the current phase detector frequency. This requires PLL2\_R to be increased from a value of 1 to 2 to reduce the PLL2 phase detector frequency from 122.88 MHz to 61.44 MHz. Now the adjusted VCO frequency can be programmed to allow PLL2 to lock.

In any case where the actual VCO frequency and the display VCO frequency are not equal the user is required to manually update the PLL2\_N\_CAL register with the PLL2\_N value to be used as if the device were operating in the non-0-Delay mode. Once this update has been performed, Ctrl-L will reload the part and cause the VCO calibration to occur with the proper PLL2\_N\_CAL value.

**Table 7 - Single PLL 0-Delay Operation Examples**

	Case 1: Default Mode  No 0-Delay	Case 2: Default 0-Delay Mode (CLKout8 = 1474.56 MHz)	Case 3: Default 0-Delay Mode (Updated CLKout8 = 245.76 MHz)	Case 4: Default 0-Delay Mode (Updated CLKout8 = 61.44 MHz)
Actual PLL2 VCO Frequency	2949.12 MHz	2949.12 MHz	2949.12 MHz	2949.12 MHz
Reported PLL2 VCO Frequency	2949.12 MHz	2949.12 MHz	<b>491.52 MHz</b>	<b>122.88 MHz</b>
<b>PLL2_R</b>	1	1	1	<b>2</b>
<b>PLL2_N</b>	12	12	<b>2</b>	<b>1</b>
<b>PLL2_N_CAL</b>	<b>12</b>	<b>12</b>	<b>12</b>	<b>24</b>
PLL2_P (Pre-N)	2	2	2	2
PLL2 VCO Divider	Bypassed	Bypassed	Bypassed	Bypassed
CLKout8 Divide	12	2	12	48
Actual CLKout8 Output Frequency	<b>245.76</b>	<b>1474.56 MHz</b>	<b>245.76 MHz</b>	<b>61.44 MHz</b>
Reported CLKout8 Output Frequency	245.76	1474.56 MHz	<b>40.96 MHz</b>	<b>2.56 MHz</b>

## Appendix A: CodeLoader Usage

Code Loader is used to program the evaluation board with either an LPT port using the included CodeLoader cable or with a USB port using the optional USB-to-uWire cable available from <http://store.national.com/>. The part number is USB2UWIRE-IFACE.

### Port Setup Tab

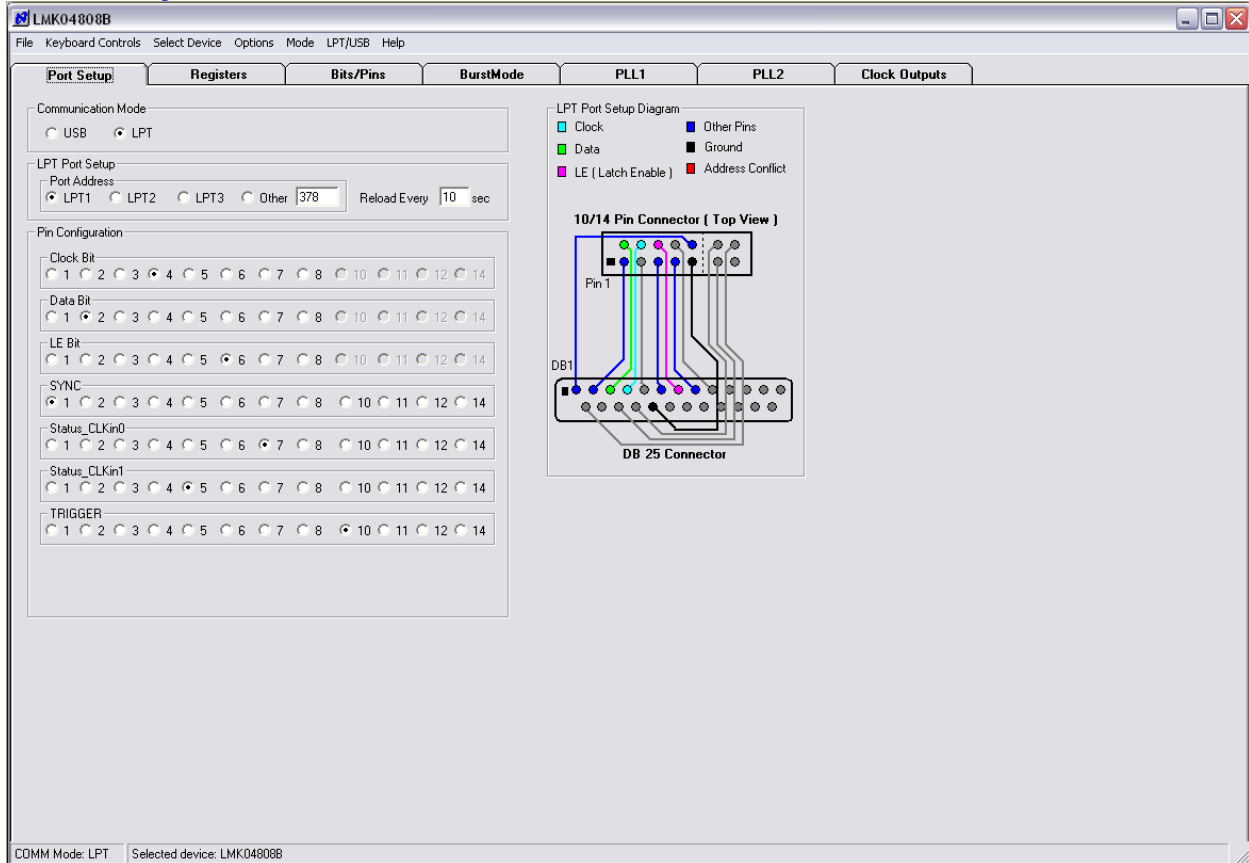

Figure 8: Port Setup tab

On the Port Setup tab, the user may select the type of communication port (USB or Parallel) that will be used to program the device on the evaluation board. If parallel port is selected, the user should ensure that the correct port address is entered.

The Pin Configuration field is hardware dependent and normally **does not** need to be changed by the user. Figure 8 shows the default settings.

## Clock Outputs Tab

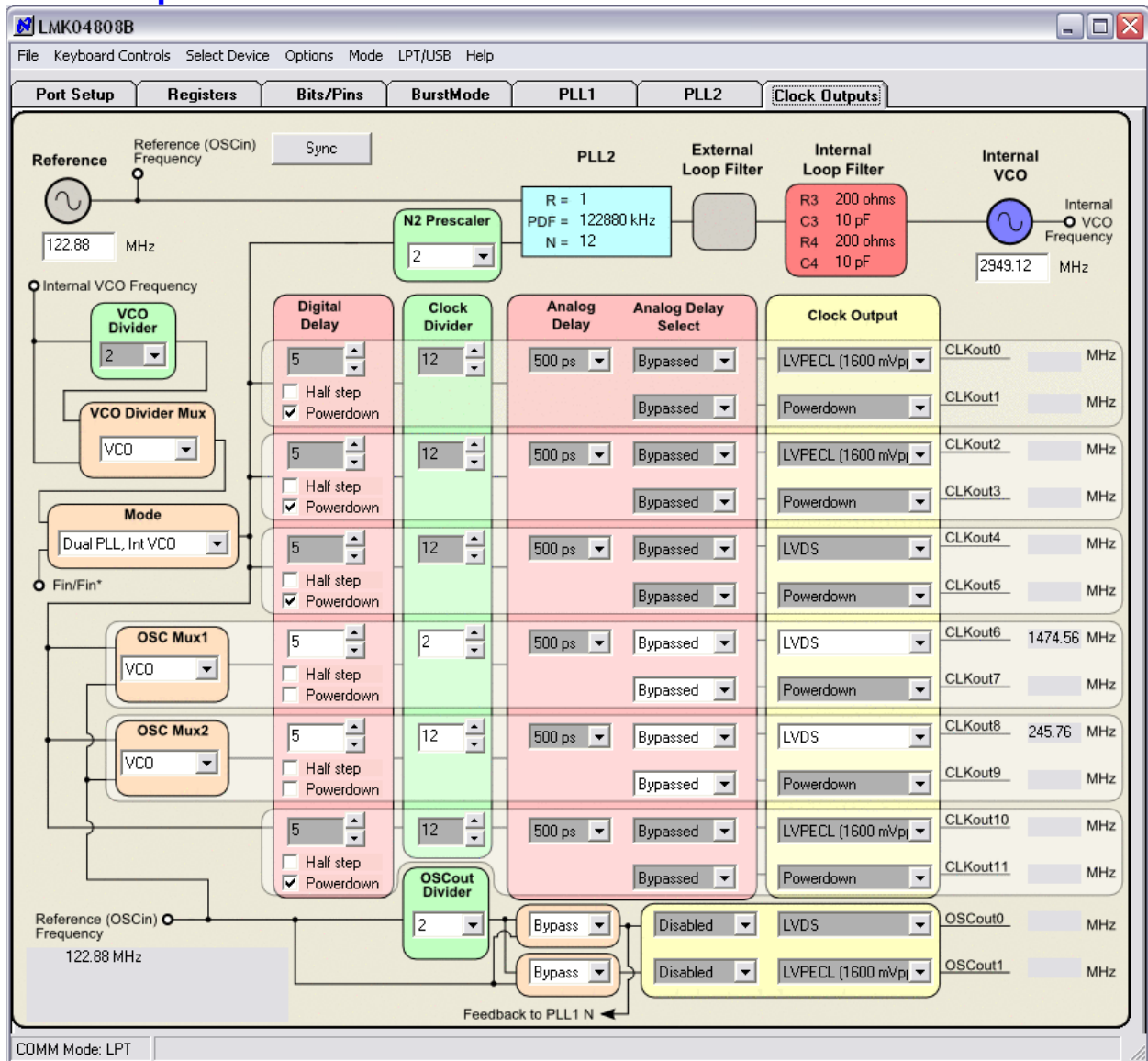

Figure 9: Clock Outputs tab

The **Clock Outputs** tab allows the user to control the output channel blocks, including:

- Clock Group Source from either VCO or OSCin (via OSC Mux1 and OSC Mux2)
- Channel Powerdown (affects digital and analog delay, clock divider, and buffer blocks)
- Digital Delay value and Half Step
- Clock Divide value
- Analog Delay value and Delay bypass/enable (per output)
- Clock Output format (per output)

This tab also allows the user to select the VCO Divider value (2 to 8). Note that the *total* PLL2 N divider value is the product of the VCO Divider value and the PLL N Prescaler and N Counter

values (shown in the **PLL2** tab), and is given by:

$$\text{PLL2 N Total} = \text{VCO Divider} * \text{PLL2 N Prescaler} * \text{PLL2 N Counter}$$

Clicking on the cyan-colored PLL2 block that contains R, PDF and N values will bring the **PLL2** tab into focus where these values may be modified, if needed.

Clicking on the values in the box containing the Internal Loop Filter component (R3, C3, R4, C4) allow one to step through the possible values. Left click to increase the component value, and right click to decrease the value. These values can also be changed in the **Bits/Pins** tab.

The Reference Oscillator value field may be changed in either the **Clock Outputs** tab or the **PLL2** tab. The PLL2 Reference frequency should match the frequency of the onboard VCXO or Crystal (i.e. VCO frequency in the **PLL1** tab); if not, a warning message will appear to indicate that the PLL(s) may be out of lock, as highlighted by the red box in Figure 10.

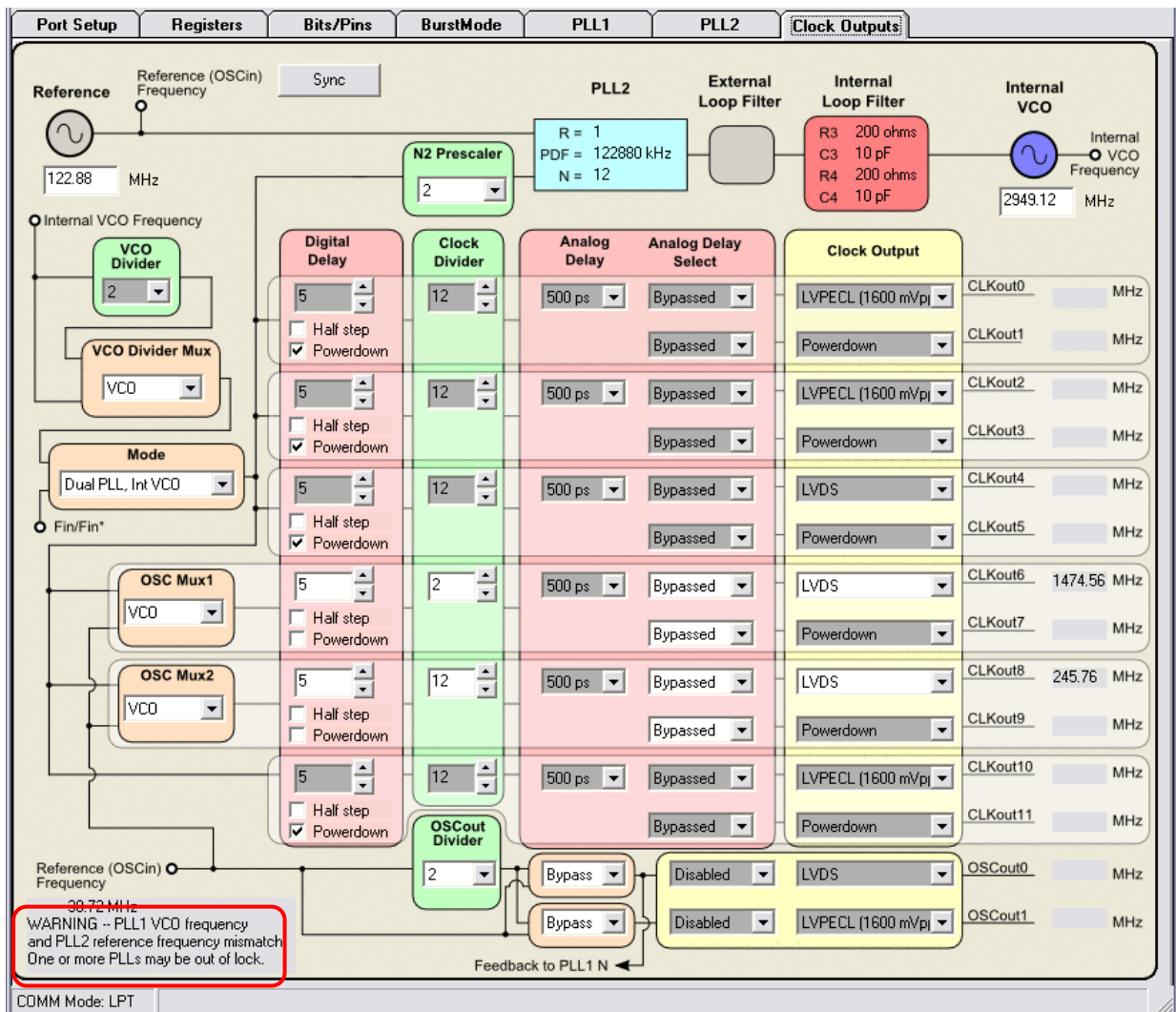

**Figure 10: Warning message indicating mismatch between PLL1 VCO frequency (30.72MHz) and PLL2 reference frequency (122.88 MHz)**

## PLL1 Tab

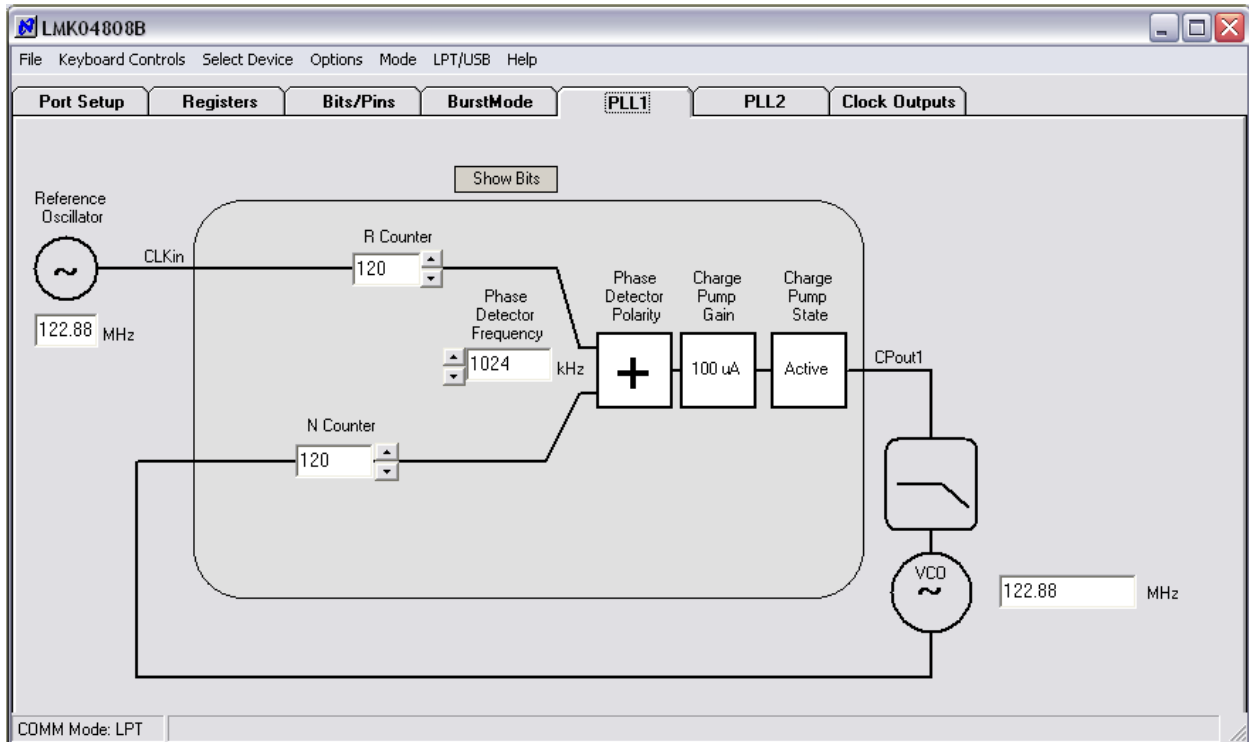

Figure 11: PLL1 tab

The PLL1 tab allows the user to change the following parameters in Table 8.

Table 8: Registers Controls and Descriptions in PLL1 tab

Control Name	Register Name	Description
Reference Oscillator Frequency (MHz)	n/a	CLKin frequency of the selected reference clock.
Phase Detector Frequency (MHz)	n/a	PLL1 Phase Detector Frequency (PDF). This value is calculated as: $\text{PLL1 PDF} = \text{CLKin Frequency} / (\text{PLL1\_R} * \text{CLKinX\_PreR\_DIV})$ where CLKinX_PreR_DIV is the predivider value of the selected input clock.



VCO Frequency (MHz)	n/a	The VCO Frequency should be the OSCin frequency, except when operating in Dual PLL with 0-delay feedback. This value is calculated as: VCO Freq (OSCin freq) = PLL1 PDF * PLL1_N. In Dual PLL mode with 0-delay feedback, the VCO frequency should be set to the feedback clock input frequency. See the section Setting the PLL1 VCO Frequency and PLL2 Reference Frequency for details.
R Counter	PLL1_R	PLL1 R Counter value (1 to 16383).
N Counter	PLL1_N	PLL1 N Counter value (1 to 16383).
Phase Detector Polarity	PLL1_CP_POL	PLL1 Phase Detector Polarity. Click on the polarity sign to toggle polarity “+” or “-”.
Charge Pump Gain	PLL1_CP_GAIN	PLL1 Charge Pump Gain. Left-click/right-click to increase/decrease charge pump gain (100, 200, 400, 1600 uA).
Charge Pump State	PLL1_CP_TRI	PLL1 Charge Pump State. Click to toggle between Active and Tri-State.

### Setting the PLL1 VCO Frequency and PLL2 Reference Frequency

When operating in Dual PLL mode without 0-delay feedback, the VCO frequency value on the **PLL1** tab must match the Reference Oscillator (OSCin) frequency value on the **PLL2** tab; otherwise, the one or both PLLs may be out of lock. Updating the Reference Oscillator frequency on the **PLL2** tab will automatically update the value of OSCin\_FREQ on the **Bits/Pins** tab.

However, when operating in Dual PLL mode with 0-delay feedback, it may be valid for the VCO frequency value on the **PLL1** tab to be different from the Reference Oscillator (OSCin) frequency value on the **PLL2** tab. This is because in 0-delay mode, the PLL1 feedback clock is taken from an output clock instead of the OSCin clock. For example, if the CLKin frequency (to PLL1\_R) is 30.72 MHz, the 0-delay feedback clock frequency (to PLL1\_N) is 30.72 MHz, and the VCXO frequency is 122.88 MHz, then the VCO frequency value on the **PLL1** tab should be 30.72 MHz (0-delay feedback frequency) and the Reference Oscillator frequency value on the **PLL2** tab should be 122.88 MHz (VCXO frequency). Because of the mismatched frequencies, a warning message will indicate this condition on the **Clock Outputs** tab but may be disregarded in a case like this.

## PLL2 Tab

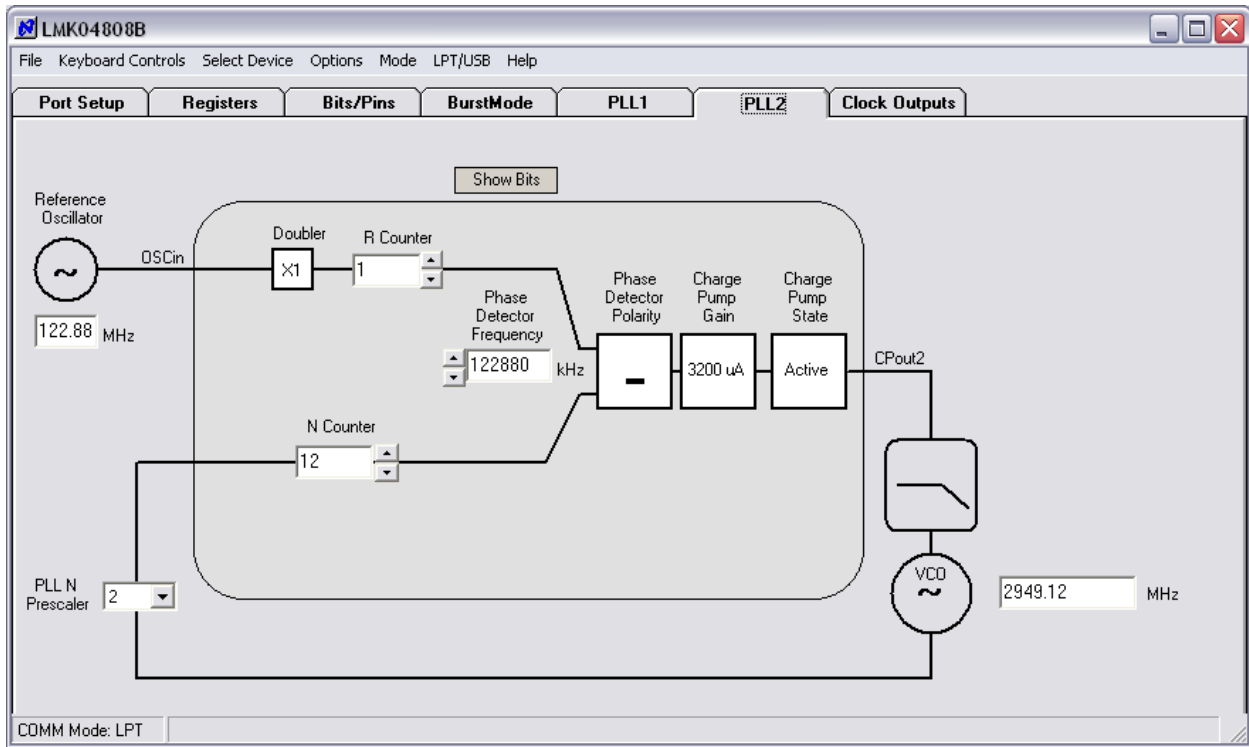

Figure 12: PLL2 tab

The PLL2 tab allows the user to change the following parameters in Table 9.

Table 9: Registers Controls and Descriptions in PLL2 tab

Control Name	Register Name	Description
Reference Oscillator Frequency (MHz)	OSCin_FREQ	OSCin frequency from the External VCXO or Crystal.
Phase Detector Frequency (MHz)	n/s	PLL2 Phase Detector Frequency (PDF). This value is calculated as: $PLL2\ PDF = OSCin\ Frequency * (2^{EN\_PLL2\_REF\_2X}) / PLL2\_R.$
VCO Frequency (MHz)	n/a	Internal VCO Frequency should be within the allowable range of the LMK048xxB device. This value is calculated as: $VCO\ Frequency = PLL2\ PDF * (PLL2\_N * PLL2\_P * VCO\ divider\ value).$
Doubler	EN_PLL2_REF_2X	PLL2 Doubler. 0 = Bypass Doubler 1 = Enable Doubler
R Counter	PLL2_R	PLL2 R Counter value (1 to 4095).
N Counter	PLL2_N	PLL2 N Counter value (1 to 262143).
PLLN Prescaler	PLL2_P	PLL2 N Prescaler value (2 to 8).

Phase Detector Polarity	PLL2_CP_POL	PLL2 Phase Detector Polarity. Click on the polarity sign to toggle polarity “+” or “-”.
Charge Pump Gain	PLL2_CP_GAIN	PLL2 Charge Pump Gain. Left-click/right-click to increase/decrease charge pump gain (100, 400, 1600, 3200 uA).
Charge Pump State	PLL2_CP_TRI	PLL2 Charge Pump State. Click to toggle between Active and Tri-State.

Changes made on this tab will be reflected in the **Clock Outputs** tab. The VCO Frequency should conform to the specified internal VCO frequency range for the LMK048xxB device (per Table 2).

### Bits/Pins Tab

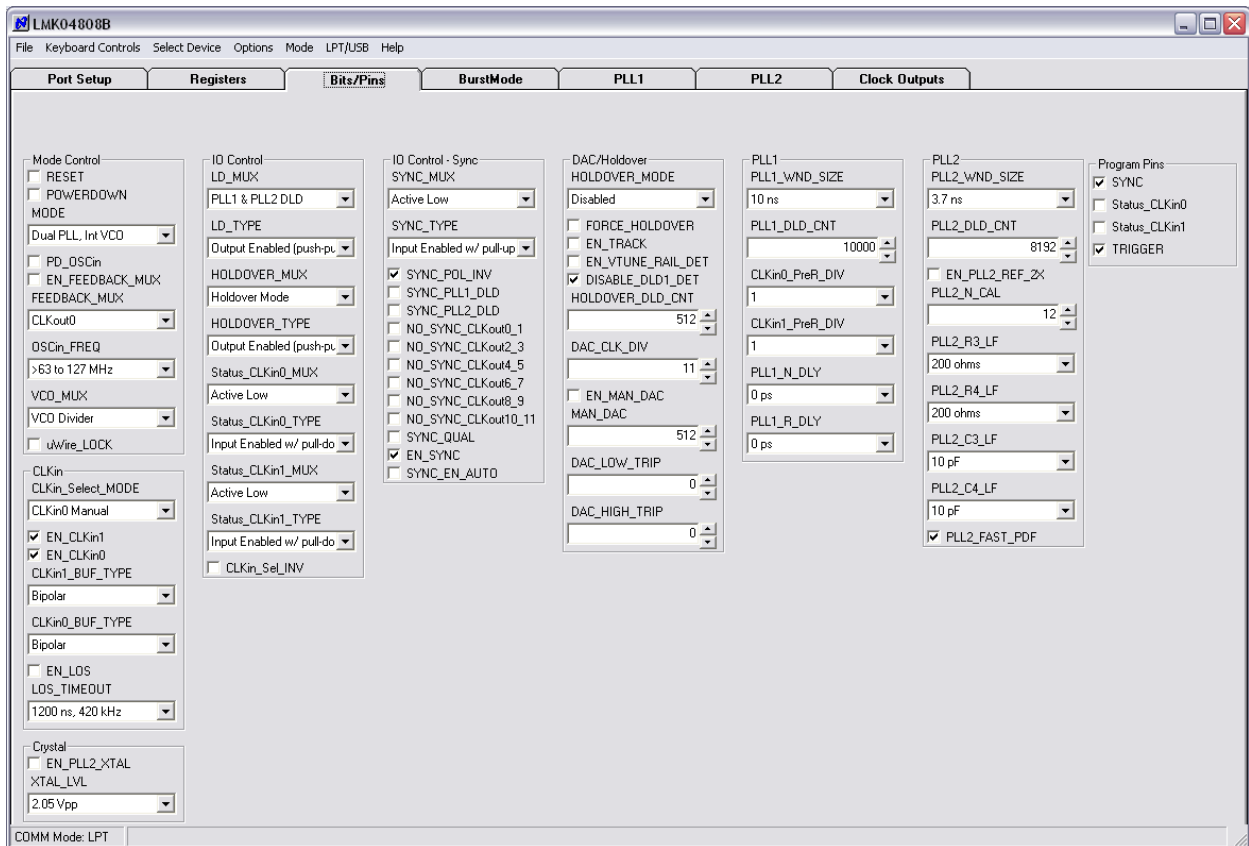

Figure 13: Bits/Pins tab

The **Bits/Pins** tab allows the user to program bits directly, many of which are not available on other tabs. Brief descriptions for the controls on this tab are provided in Table 10 to supplement the datasheet. Refer to the [LMK04800 Family Datasheet](#) for more information.

**TIP:** Right-clicking any register name in the **Bits/Pins** tab will display a Help prompt with the register address, data bit location/length, and a brief register description.



**Table 10: Register Controls and Descriptions on Bits/Pins tab**

Group	Register Name	Description
Mode Control	RESET	Resets the device to default register values. RESET must be cleared for normal operation to prevent an unintended reset every time R0 is programmed.
	POWERDOWN	Places the device in powerdown mode.
	MODE	Selects the operating mode (topology) for the LMK048xx device.
	PD_OSCin	Powers down the OSCin buffer. For use in Clock Distribution mode if OSCin path is not used.
	FEEDBACK_MUX	Selects the feedback source for 0-delay mode.
	OSCin_FREQ	Must be set to the OSCin frequency range for PLL2. Used for proper operation of the internal VCO calibration routine. Entering a reference oscillator frequency on PLL2 tab will automatically update OSCin_FREQ to the proper frequency range.
	VCO_MUX	Selects between VCO and VCO divider to drive the clock distribution path. The VCO divider is only valid if MODE is selecting the Internal VCO.
	uWire_LOCK	When checked, no other uWire programming will have effect. Must be unchecked to enable uWire programming of registers R0 to R30.
CLKin	CLKin_Select_MODE	Selects operational mode for how the device selects the reference clock for PLL1.
	EN_CLKin1	Enables CLKin1 as a usable reference input during auto switching mode.
	EN_CLKin0	Enables CLKin0 as a usable reference input during auto switching mode.
	CLKinX_BUF_TYPE	Selects the CLKinX input buffer to Bipolar (internal 0 mV offset) or MOS (internal 55 mV offset).
	EN_LOS	Enable the Loss-Of-Signal (LOS) detect circuitry.
	LOS_TIMEOUT	Sets the timeout value for the LOS detect circuitry to assert a loss of signal state on a clock input.
Crystal	EN_PLL2_XTAL	Enables Crystal Oscillator
	XTAL_LVL	Sets peak amplitude on the tunable crystal. Values listed are for a 20.48 MHz crystal.
IO Control	LD_MUX	Sets the selected signal on the Status_LD pin.
	LD_TYPE	Sets I/O pin type on the Status_LD pin.
	HOLDOVER_MUX	Sets the selected signal on the Status_HOLDOVER pin.



	HOLDOVER_TYPE	Sets I/O pin type on the Status_Holdover pin.
	Status_CLKin0_MUX	Sets the selected signal on the Status_CLKin0 pin.
	Status_CLKin0_TYPE	Sets I/O pin type on the Status_CLKin0 pin.
	Status_CLKin1_MUX	Sets the selected signal on the Status_CLKin1 pin.
	Status_CLKin1_TYPE	Sets I/O pin type on the Status_CLKin1 pin.
	CLKin_Sel_INV	Inverts the Status_CLKin0/1 pin polarity when set to an input type. Significant when CLKin_SELECT_MODE is 3 or 6.
IO Control – Sync	SYNC_MUX	Sets the selected signal on the SYNC pin.
	SYNC_TYPE	Sets I/O pin type on the SYNC pin.
	SYNC_POL_INV	Sets polarity on SYNC input to active low when checked. Toggling this bit will initiate a SYNC event.
	SYNC_PLL1_DLD	Engage SYNC mode until PLL1 DLD is true
	SYNC_PLL2_DLD	Engage SYNC mode until PLL2 DLD is true
	NO_SYNC_CLKoutX_Y	Synchronization will not affect selected clock outputs, where X = even-numbered output and Y = odd-numbered output.
	SYNC_QUAL	Sets the SYNC to qualify mode for dynamic digital delay.
	EN_SYNC	Must be set when using SYNC, but may be cleared after the SYNC event. When using dynamic digital delay (SYNC_QUAL = 1), EN_SYNC must always be set. Changing this value from 0 to 1 can cause a SYNC event, so clocks which should not be SYNCed when setting this bit should have the NO_SYNC_CLKoutX_Y bit set. <b>NOTE:</b> This bit is not a valid method of generating a SYNC event. Use one of the other SYNC generation methods to ensure a proper SYNC occurs.
SYNC_EN_AUTO	Enable auto SYNC when R0 to R5 is written.	
DAC/Holdover	HOLDOVER_MODE	Sets holdover mode to be disabled or enabled.
	FORCE_HOLDOVER	Engages holdover when checked regardless of HOLDOVER_MODE value. Turns the DAC on.
	EN_TRACK	Enables DAC tracking. DAC tracks the PLL1 Vtune to provide for an accurate HOLDOVER mode. DAC_CLK_DIV should also be set so that DAC update rate is <= 100 kHz.
	EN_VTUNE_RAIL_DET	Allows rail-to-rail operation of VCXO with default of 0. Allows use of DAC_LOW_TRIP, DAC_HIGH_TRIP. Must be used with EN_MAC_DAC = 1. CLKin_SELECT_MODE must be 4 or 6 (auto mode) to use.



	HOLD_DLD_CNT	In HOLDOVER mode, wait for this many clocks of PLL1 PDF within the tolerances of PLL1_WND_SIZE before exiting holdover mode.
	DAC_CLK_DIV	DAC update clock is the PLL1 phase detector divided by this divisor. For proper operation, DAC update clock rate should be $\leq 100$ kHz. DAC update rate = PLL1 phase detector frequency / DAC_CLK_DIV
	EN_MAN_DAC	Enables manual DAC mode and set DAC voltage when in holdover.
	MAN_DAC	Sets the value for the DAC when EN_MAN_DAC is 1 and holdover is engaged. Readback from this register is the current DAC value whether in manual DAC mode or DAC tracking mode
	DAC_LOW_TRIP	Value from GND in $\sim 50$ mV steps at which a clock switch event is generated. If Holdover mode is enabled, it will be engaged upon the clock switch event. NOTE: EN_VTUNE_RAIL_DET must be enabled for this to be valid.
	DAC_HIGH_TRIP	Value from VCC (3.3V) in $\sim 50$ mV steps at which clock switch event is generated. If Holdover mode is enabled, it will be engaged upon the clock switch event. NOTE: EN_VTUNE_RAIL_DET must be enabled for this to be valid.
PLL1	PLL1_WND_SIZE	If the phase error between the PLL1 reference and feedback clocks is less than specified time, then the PLL1 lock counter increments. NOTE: Final lock detect valid signal is determined when the PLL1 lock counter meets or exceeds the PLL1_DLD_CNT value.
	PLL1_DLD_CNT	The reference and feedback of PLL1 must be within the window of phase error as specified by PLL1_WND_SIZE for this many cycles before PLL1 digital lock detect is asserted.
	CLKinX_PreR_DIV	The PreR dividers divide the CLKinX reference before the PLL1_R divider. Unique divides on individual CLKinX signals allows switchover from one clock input to another clock input without needing to reprogram the PLL1_R divider to keep the device in lock.
	PLL1_N_DLY	N delay causes clock outputs to lead clock input when in a 0-delay mode. Increasing the N delay value increases the output phase lead relative to the input.



	PLL1_R_DLY	R delay causes clock outputs to lag clock input when in a 0-delay mode. Increasing the R delay value increases the output phase lag relative to the input.
PLL2	PLL2_WND_SIZE	If the phase error between the PLL2 reference and feedback clock is less than specified time, then the PLL2 lock counter increments.
	PLL2_DLD_CNT	The reference and feedback of PLL2 must be within the window of phase error as specified by PLL2_WND_SIZE for this many cycles before PLL2 digital lock detect is asserted.
	EN_PLL2_REF_2X	Enables the doubler block to double the reference frequency into the PLL2 R counter. This can allow for frequency of 2/3, 2/5, etc. of OSCin to be used at the phase detector of PLL2.
	PLL2_N_CAL	The PLL2_N_CAL register contains the N value used for the VCO calibration routine. Except during 0-delay modes, the PLL2_N and PLL2_N_CAL registers will be exactly the same.
	PLL2_R3_LF	Set the corresponding integrated PLL2 loop filter values: R3, R4, C3, and C4.
	PLL2_R4_LF	
	PLL2_C3_LF	It is also possible to set these values by clicking on the loop filter values on the <b>Clock Outputs</b> tab.
	PLL2_C4_LF	
		PLL2_FAST_PDF
Program Pins	SYNC	Sets these pins on the uWire header to logic high (checked) or logic low (unchecked).
	Status_CLKin0	
	Status_CLKin1	

## Registers Tab

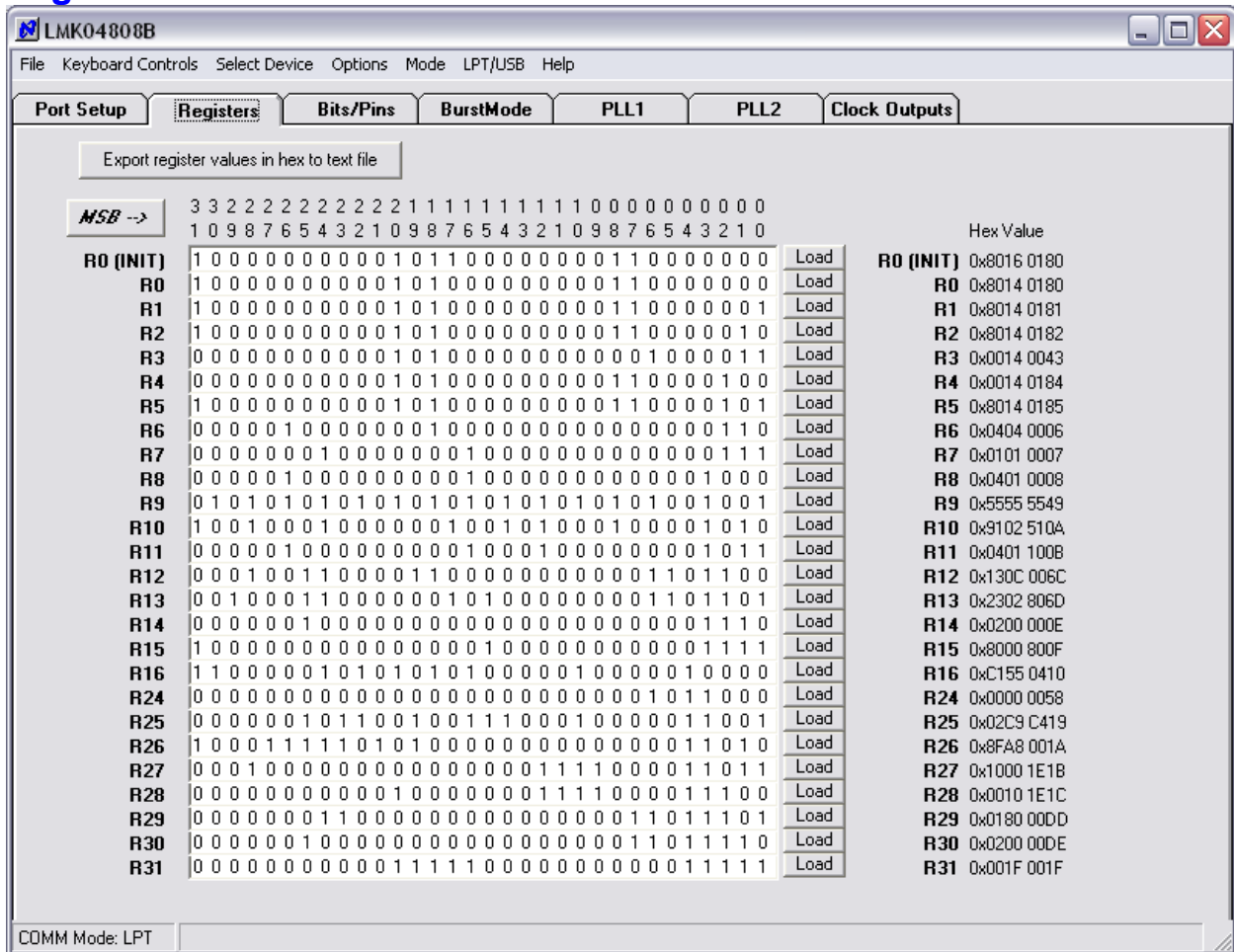

Figure 14: Registers Tab

The Registers tab shows the value of each register. This is convenient for programming the device to the desired settings, then exporting to a text file the register values in hexadecimal for use in your own application.

By clicking in the “bit field” it is possible to manually change the value of registers by typing ‘1’ and ‘0.’

## Appendix B: Typical Phase Noise Performance Plots

### PLL1

The LMK048xxB’s dual PLL architecture achieves ultra low jitter and phase noise by allowing the external VCXO or Crystal’s phase noise to dominate the final output phase noise at low offset frequencies and the internal VCO’s phase noise to dominate the final output phase noise at high offset frequencies. This results in the best overall noise and jitter performance.

Table 11 lists the test conditions used for output clock phase noise measurements with the Crystek 122.88 MHz VCXO.

**Table 11: LMK048xxB Test Conditions**

Parameter	Value
PLL1 Reference clock input	CLKin0 single-ended input, CLKin0* AC-coupled to GND
PLL1 Reference Clock frequency	122.88 MHz
PLL1 Phase detector frequency	122.88 MHz
PLL1 Charge Pump Gain	100 uA
VCXO frequency	122.88 MHz
PLL2 phase detector frequency	122.88 MHz
PLL2 Charge Pump Gain	3200 uA
PLL2 REF2X mode	Disabled

### 122.88 MHz VCXO Phase Noise

The phase noise of the reference is masked by the phase noise of this VCXO by using a narrow loop bandwidth for PLL1 while retaining the frequency accuracy of the reference clock input. This VCXO sets the reference noise to PLL2. Figure 15 shows the open loop typical phase noise performance of the CVHD-950-122.88 Crystek VCXO.

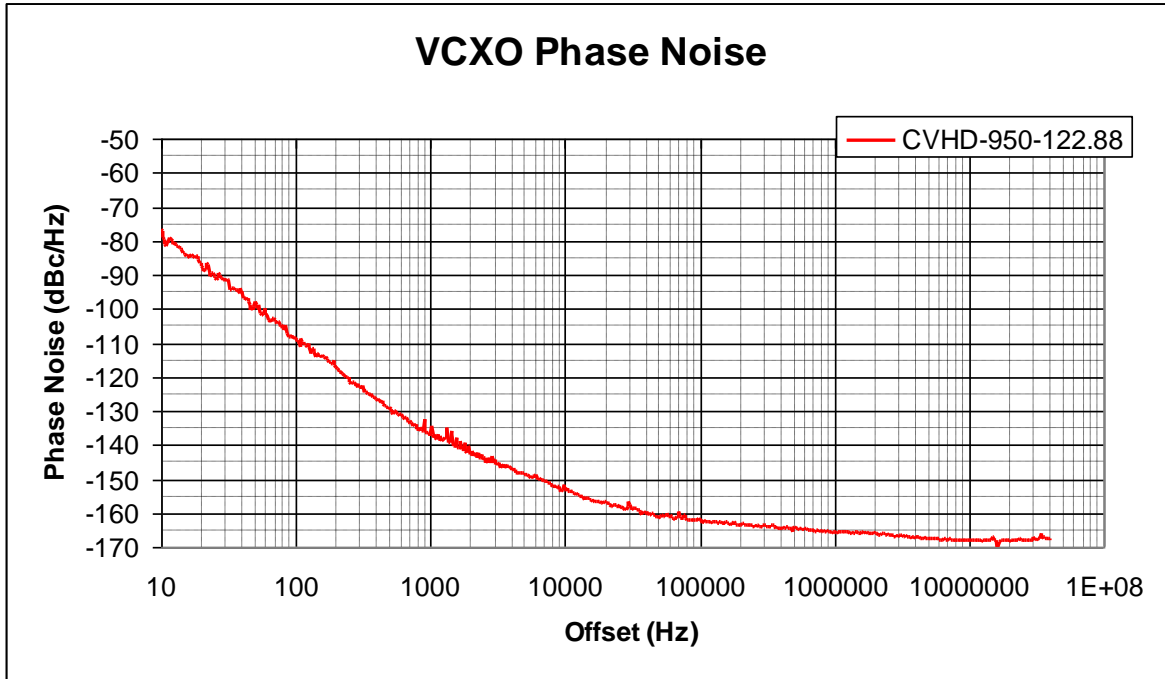

Figure 15: Crystek CVHD-950-122.88 MHz VCXO Phase Noise at 122.88 MHz

Table 12: VCXO Phase Noise at 122.88 MHz (dBc/Hz)

Offset	Phase Noise
10 Hz	-76.6
100 Hz	-108.9
1 kHz	-137.4
10 kHz	-153.3
100 kHz	-162.0
1 MHz	-165.7
10 MHz	-168.1
40 MHz	-168.1

Table 13: VCXO RMS Jitter to high offset of 20 MHz at 122.88 MHz (rms fs)

Low Offset	Jitter
10 Hz	515.4
100 Hz	60.5
1 kHz	36.2
10 kHz	35.0
100 kHz	34.5
1 MHz	32.9
10 MHz	22.7

## Clock Output Measurement Technique

The same technique was used to measure phase noise for all three output types available on the programmable OSCout and CLKout buffers. This was achieved by terminating one side of the LVPECL, LVDS, or LVC MOS output with a 50-ohm load, and measuring the other side single-ended using an Agilent E5052B Source Signal Analyzer.

## Buffered OSCout Phase Noise

Both OSCout0 and OSCout1 frequencies are 122.88 MHz since the OSCout Divider is bypassed. OSCout0 is programmed to LVC MOS mode and OSCout1 is fixed as LVPECL.

## Clock Outputs (CLKout)

The LMK04800 Family features programmable LVDS, LVPECL, and LVCMOS buffer modes for the CLKoutX and OSCout0 output pairs. The OSCout1 output pair has a LVPECL buffer. Included below are various phase noise measurements for each output format.

### LMK04808B CLKout Phase Noise

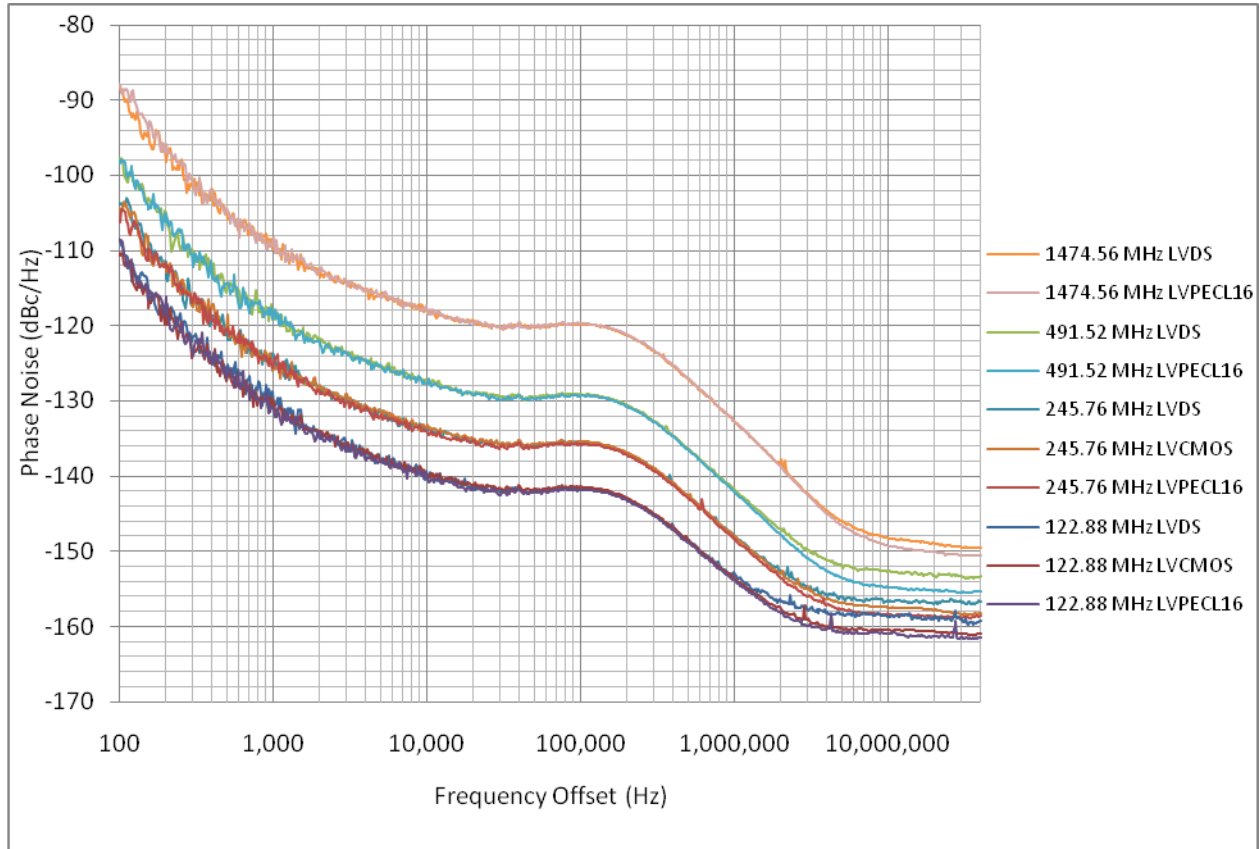

Figure 16: LMK04808B CLKout Phase Noise

Table 14: LMK04808B Phase Noise (dBc/Hz) Phase Noise and RMS Jitter (fs)

Offset	1474.56 MHz LVDS	1474.56 MHz LVPECL	491.52 MHz LVDS	491.52 MHz LVPECL
100 Hz	-88.2	-87.8	-97.7	-99.7
1 kHz	-109.8	-108.9	-118.9	-119.3
10 kHz	-118.0	-117.4	-127.3	-127.4
100 kHz	-119.8	-119.7	-129.1	-129.4
800 kHz	-130.9	-130.8	-140.1	-140.3
1 MHz	-132.7	-132.6	-141.7	-142.1
10 MHz	-148.2	-149.2	-152.7	-154.9
20 MHz	-148.9	-150.1	-153.2	-155.3
<b>RMS Jitter (fs)</b> 10 kHz to 20 MHz	99.3	99.4	109.1	103.3
<b>RMS Jitter (fs)</b> 100 Hz to 20 MHz	111.4	113.5	121.3	116.1





For the LMK04808B, the internal VCO frequency is 2949.12 MHz. The divide-by-12 CLKout frequency is 245.76 MHz, and the divide-by-24 CLKout frequency is 122.88 MHz.

**Table 15: LMK04808B Phase Noise and RMS Jitter for Different CLKout Output Formats and Frequencies**

Offset	245.76 LVDS	245.76 LVCMOS	245.76 LVPECL	122.88 LVDS	122.88 LVCMOS	122.88 LVPECL
100 Hz	-103.7	-104.4	-106.1	-108.4	-110.4	-108.5
1 kHz	-123.7	-125.9	-125.7	-128.7	-129.7	-130.9
10 kHz	-133.8	-133.5	-134.0	-139.3	-139.8	-140.0
100 kHz	-135.5	-135.4	-135.8	-141.7	-141.4	-141.8
800 kHz	-146.4	-146.3	-146.7	-151.7	-152.1	-152.4
1 MHz	-147.9	-148.0	-148.3	-152.9	-153.4	-153.8
10 MHz	-156.5	-157.5	-158.3	-158.7	-160.5	-161.0
20 MHz	-156.9	-157.8	-158.6	-158.8	-160.7	-161.3
<b>RMS Jitter (fs)</b> 10 kHz to 20 MHz	111.8	109.6	103.9	133.4	122.1	116.1
<b>RMS Jitter (fs)</b> 100 Hz to 20 MHz	124.3	122.1	115.4	144.4	132.3	127.9

## LMK04808B OSCout Phase Noise

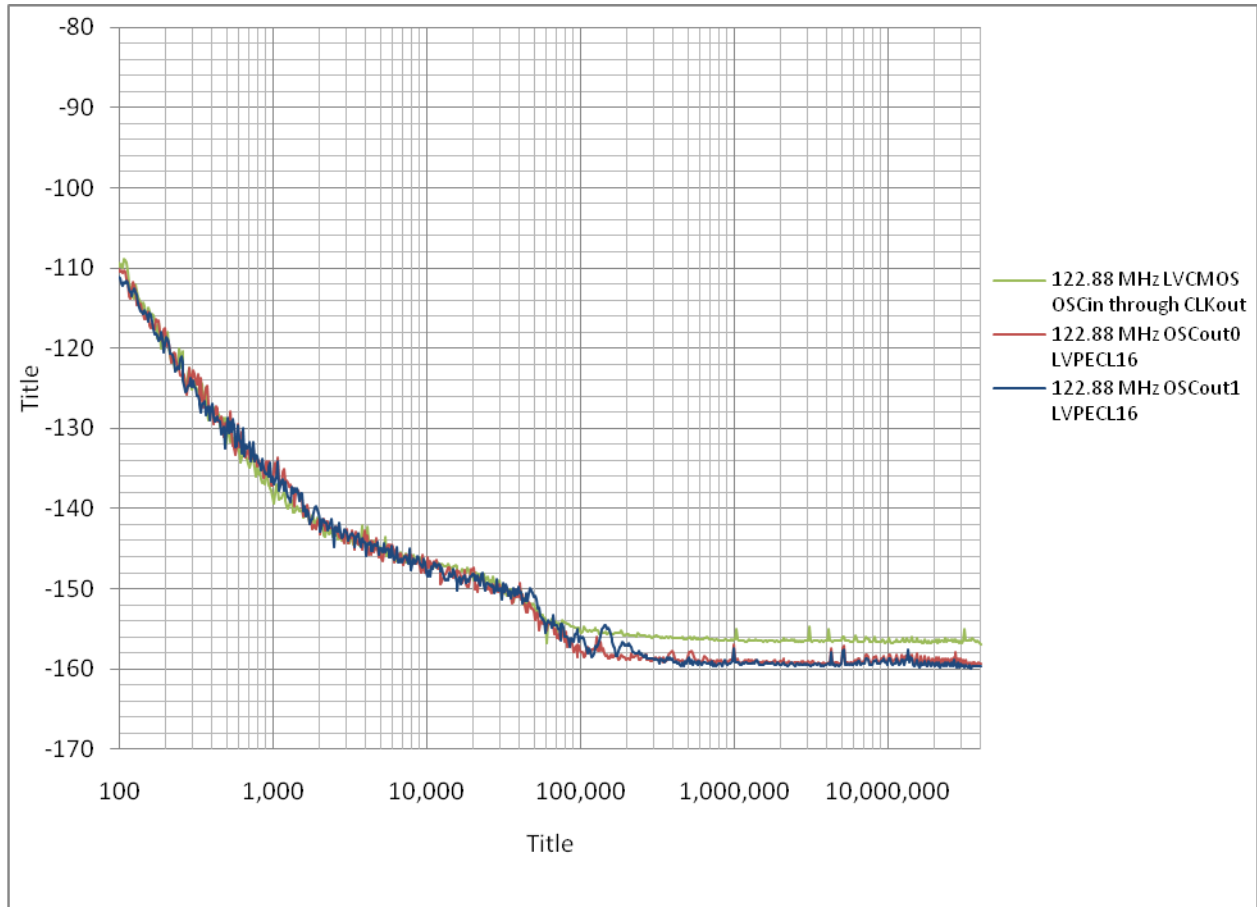

Figure 17: LMK04808B OSCout Phase Noise

Table 16: LMK04808B OSCout Phase Noise and RMS Jitter (fs)

Offset	OSCout0 LVPECL	OSCout1 LVPECL	OSCin thru CLKout
100 Hz	-110.2	-111.1	-109.4
1 kHz	-137.2	-136.1	-138.6
10 kHz	-148.0	-148.0	-146.7
100 kHz	-157.8	-156.0	-155.3
800 kHz	-159.1	-159.4	-156.4
1 MHz	-157.0	-157.5	-156.3
10 MHz	-158.8	-159.2	-156.7
20 MHz	-159.2	-159.5	-156.7
<b>RMS Jitter (fs)</b> 10 kHz to 20 MHz	94.1	91.0	123.7
<b>RMS Jitter (fs)</b> 100 Hz to 20 MHz	103.2	99.6	131.3



### LMK04806B CLKout Phase Noise

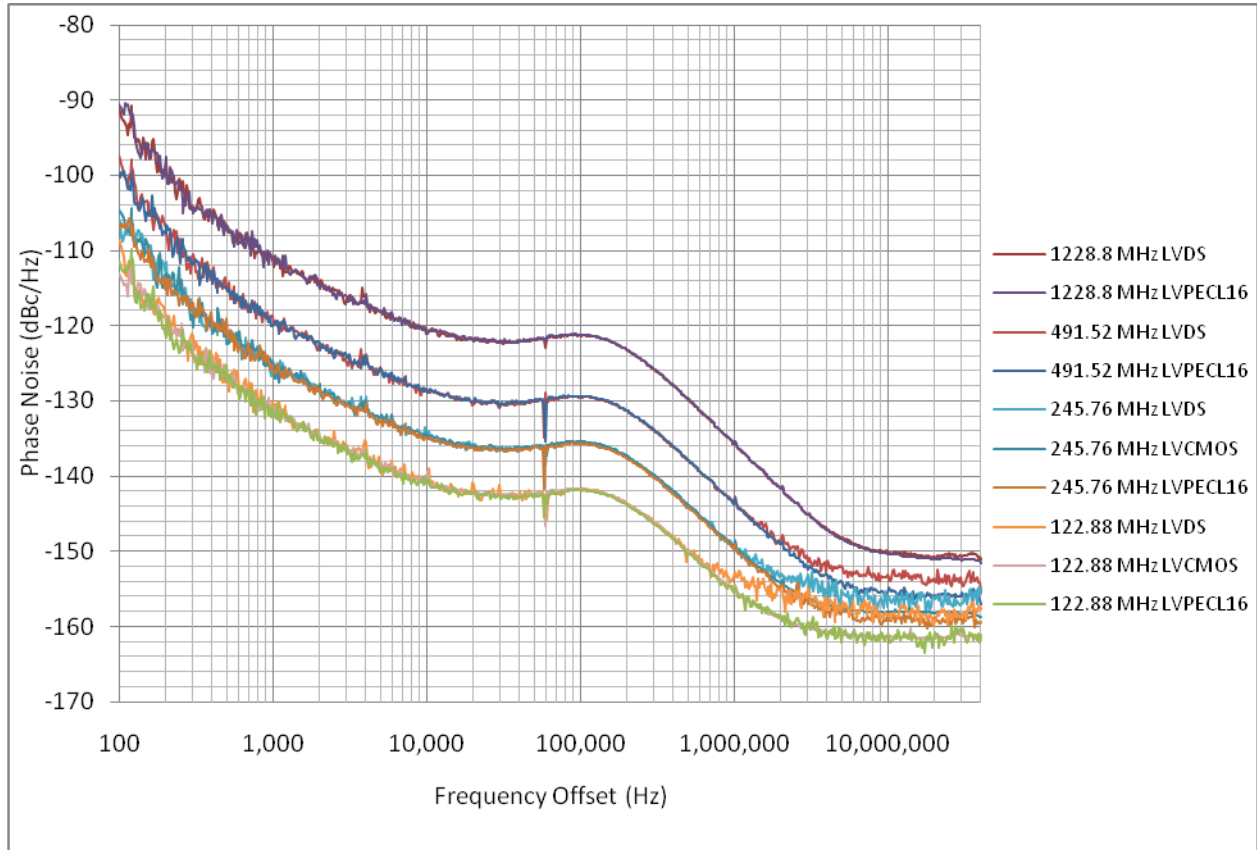

Figure 18: LMK04806B CLKout Phase Noise

Table 17: LMK04806B Phase Noise (dBc/Hz) Phase Noise and RMS Jitter (fs)

Offset	1228.80 MHz LVDS	1228.80 MHz LVPECL	491.52 MHz LVDS	491.52 MHz LVPECL
100 Hz	-91.2	-90.5	-97.5	-98.2
1 kHz	-111.2	-110.8	-118.7	-119.4
10 kHz	-121.0	-121.1	-128.5	-128.6
100 kHz	-121.3	-121.2	-129.5	-129.5
800 kHz	-133.8	-133.7	-141.9	-141.9
1 MHz	-135.8	-135.7	-143.4	-143.8
10 MHz	-150.2	-150.4	-153.1	-155.7
20 MHz	-150.8	-151.0	-153.8	-155.7
RMS Jitter (fs) 10 kHz to 20 MHz	92.9	93.4	97.5	94.5
RMS Jitter (fs) 100 Hz to 20 MHz	104.0	105.3	109.0	105.4

For the LMK04806B, the internal VCO frequency is 2457.60 MHz. The divide-by-10 CLKout frequency is 245.76 MHz, and the divide-by-20 CLKout frequency is 122.88 MHz.

**Table 18: LMK04806B Phase Noise and RMS Jitter for Different CLKout Output Formats and Frequencies**

<b>Offset</b>	<b>245.76 LVDS</b>	<b>245.76 LVCMOS</b>	<b>245.76 LVPECL</b>	<b>122.88 LVDS</b>	<b>122.88 LVCMOS</b>	<b>122.88 LVPECL</b>
<b>100 Hz</b>	-105.8	-104.5	-106.5	-108.6	-113.0	-111.4
<b>1 kHz</b>	-124.7	-124.9	-125.4	-130.2	-132.1	-131.0
<b>10 kHz</b>	-134.8	-134.4	-134.9	-140.7	-140.7	-141.0
<b>100 kHz</b>	-135.5	-135.4	-135.8	-141.7	-141.7	-141.9
<b>800 kHz</b>	-147.8	-147.7	-148.0	-152.6	-153.5	-154.1
<b>1 MHz</b>	-149.6	-149.4	-149.7	-153.3	-155.2	-155.5
<b>10 MHz</b>	-156.1	-158.1	-158.4	-158.4	-161.5	-161.1
<b>20 MHz</b>	-156.3	-158.2	-158.9	-159.5	-161.6	-161.3
<b>RMS Jitter (fs) 10 kHz to 20 MHz</b>	106.9	101.5	96.4	134.2	109.7	108.2
<b>RMS Jitter (fs) 100 Hz to 20 MHz</b>	116.8	112.4	106.4	143.2	118.9	117.9

## LMK04806B OSCout Phase Noise

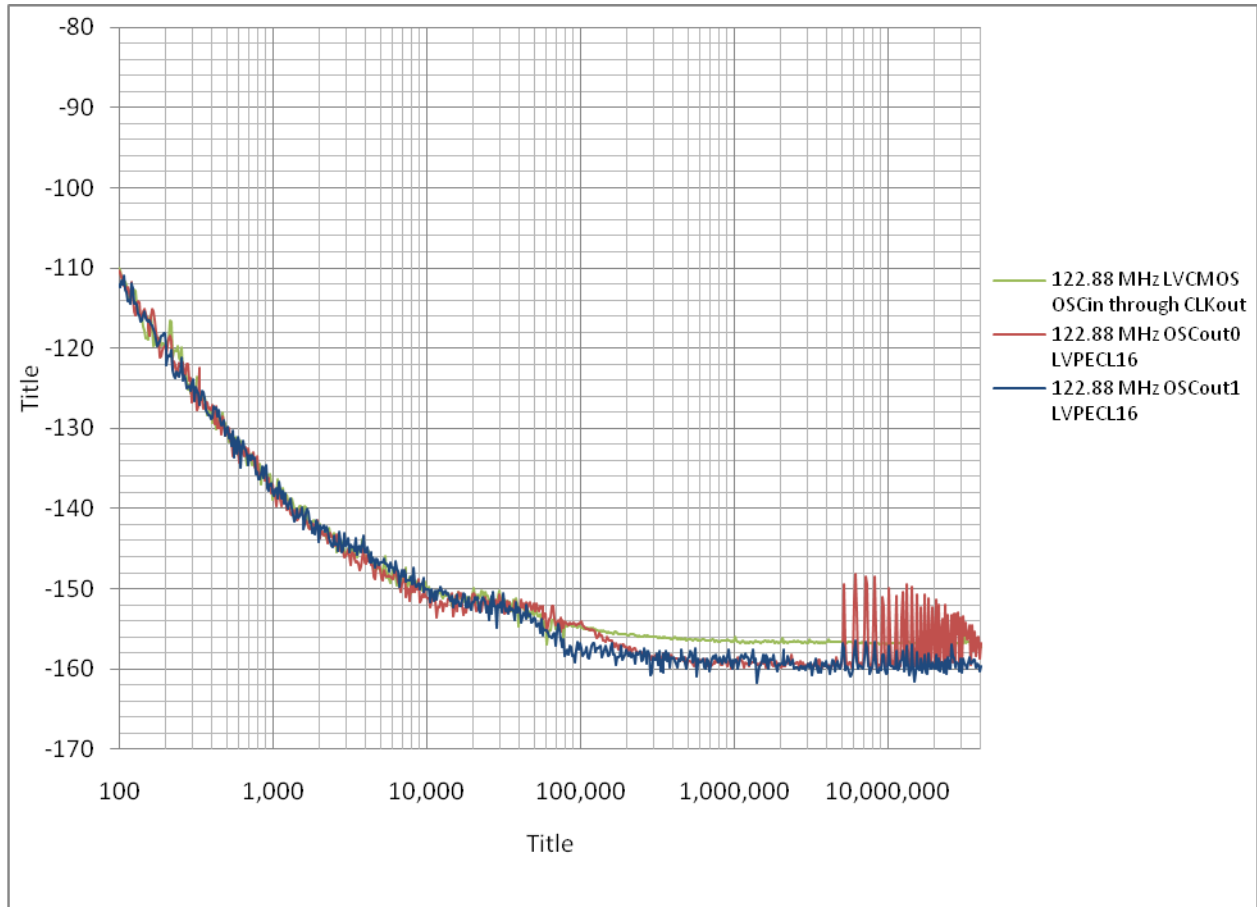

Figure 19: LMK04806B OSCout Phase Noise

Table 19: LMK04806B OSCout Phase Noise and RMS Jitter (fs)

Offset	OSCout0 LVPECL	OSCout1 LVPECL	OSCin thru CLKout
100 Hz	-110.3	-112.1	-110.0
1 kHz	-136.9	-137.9	-138.9
10 kHz	-151.1	-150.1	-150.0
100 kHz	-154.3	-156.8	-154.6
800 kHz	-158.9	-158.9	-156.6
1 MHz	-159.2	-159.1	-156.6
10 MHz	-159.4	-160.0	-156.8
20 MHz	-157.6	-159.9	-156.9
<b>RMS Jitter (fs)</b> 10 kHz to 20 MHz	138.4	89.7	120.0
<b>RMS Jitter (fs)</b> 100 Hz to 20 MHz	143.7	97.3	126.2

### LMK04803B CLKout Phase Noise

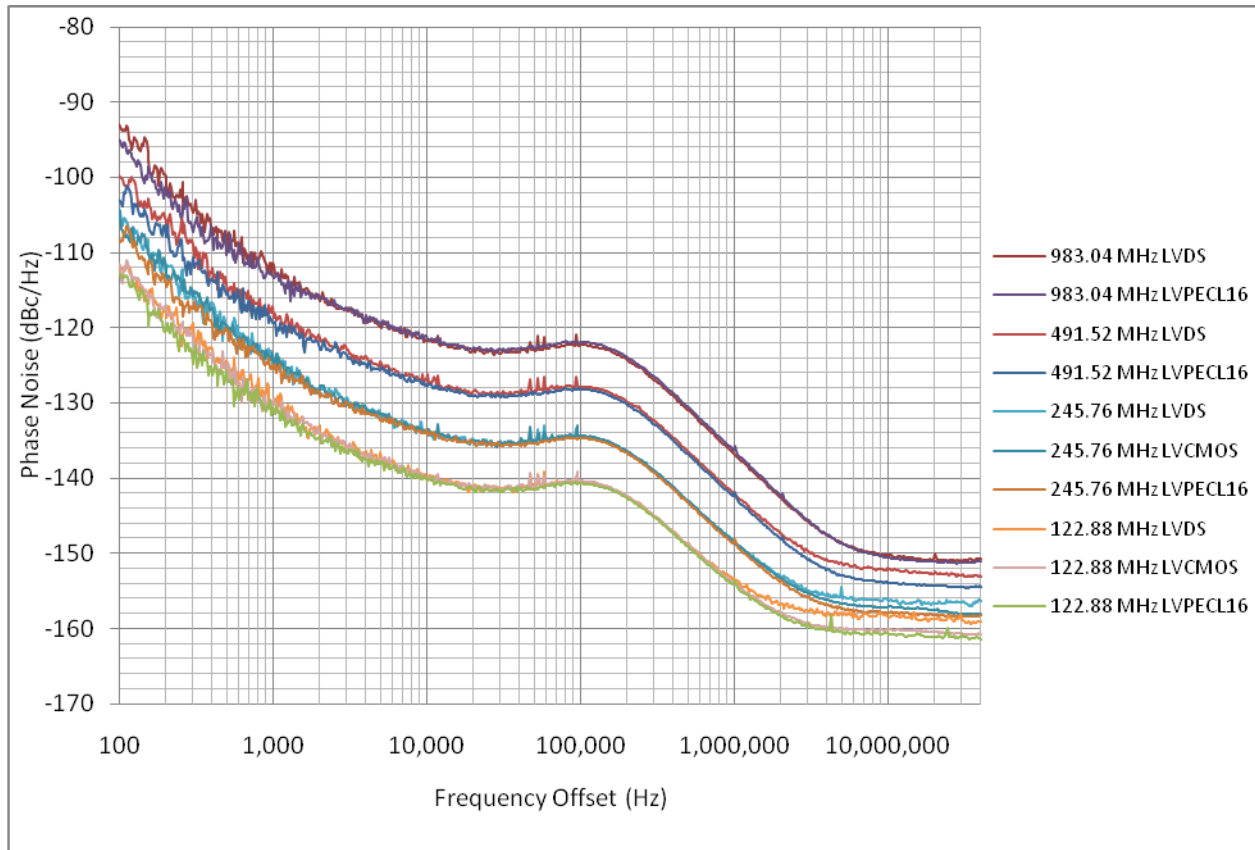

Figure 20: LMK04803B CLKout Phase Noise

Table 20: LMK04803B Phase Noise (dBc/Hz) Phase Noise and RMS Jitter (fs)

Offset	983.04 MHz LVDS	983.04 MHz LVPECL	491.52 MHz LVDS	491.52 MHz LVPECL
100 Hz	-93.0	-95.0	-99.7	-99.5
1 kHz	-111.3	-113.1	-117.1	-118.3
10 kHz	-121.8	-121.1	-126.9	-127.4
100 kHz	-122.3	-121.9	-127.8	-128.3
800 kHz	-134.9	-134.5	-140.3	-140.8
1 MHz	-136.8	-136.3	-142.0	-142.7
10 MHz	-150.3	-150.6	-152.0	-154.2
20 MHz	-150.4	-151.1	-152.6	-154.6
<b>RMS Jitter (fs)</b> 10 kHz to 20 MHz	103.8	107.4	116.0	108.1
<b>RMS Jitter (fs)</b> 100 Hz to 20 MHz	116.1	116.2	127.4	116.8

For the LMK04803B, the internal VCO frequency is 1966.08 MHz. The divide-by-8 CLKout frequency is 245.76 MHz, and the divide-by-16 CLKout frequency is 122.88 MHz.

**Table 21: LMK04803B Phase Noise and RMS Jitter for Different CLKout Output Formats and Frequencies**

<b>Offset</b>	<b>245.76 LVDS</b>	<b>245.76 LVCMOS</b>	<b>245.76 LVPECL</b>	<b>122.88 LVDS</b>	<b>122.88 LVCMOS</b>	<b>122.88 LVPECL</b>
<b>100 Hz</b>	-104.8	-104.2	-108.4	-112.1	-111.5	-112.7
<b>1 kHz</b>	-124.8	-123.5	-125.0	-130.5	-130.2	-130.6
<b>10 kHz</b>	-133.7	-134.0	-133.6	-140.1	-139.8	-140.1
<b>100 kHz</b>	-134.4	-134.4	-134.6	-140.6	-140.4	-140.7
<b>800 kHz</b>	-146.7	-146.7	-147.1	-152.5	-152.4	-152.7
<b>1 MHz</b>	-148.5	-148.5	-148.7	-153.4	-154.0	-154.0
<b>10 MHz</b>	-156.2	-157.2	-158.0	-158.4	-160.1	-160.5
<b>20 MHz</b>	-156.6	-157.5	-158.2	-158.7	-160.4	-161.1
<b>RMS Jitter (fs) 10 kHz to 20 MHz</b>	115.1	113.1	107.9	137.5	126.1	120.5
<b>RMS Jitter (fs) 100 Hz to 20 MHz</b>	126.4	124.2	116.7	147.5	136.4	128.9



### LMK04803B OSCout Phase Noise

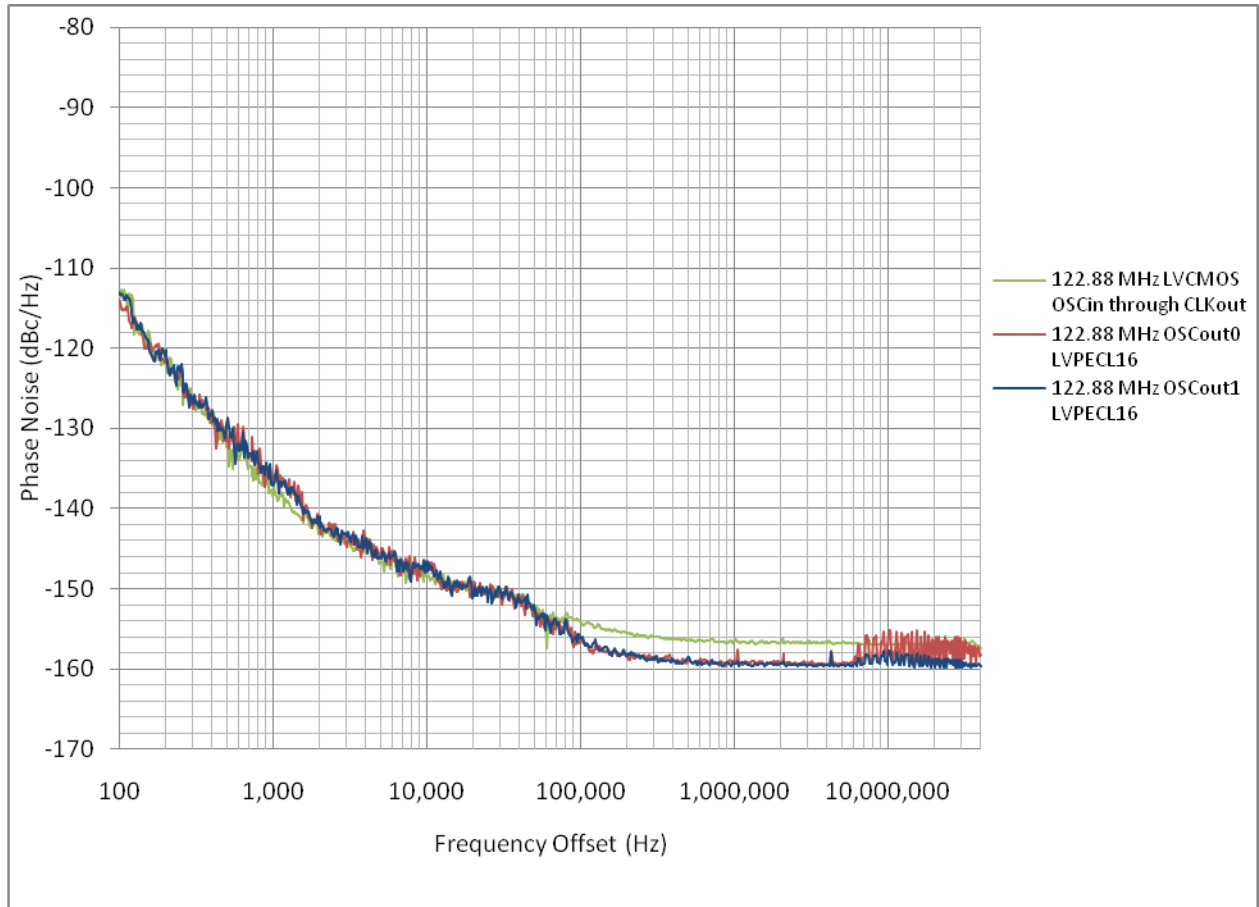

Figure 21: LMK04803B OSCout Phase Noise

Table 22: LMK04803B OSCout Phase Noise and RMS Jitter (fs)

Offset	OSCout0 LVPECL	OSCout1 LVPECL	OSCin thru CLKout
100 Hz	-114.0	-113.1	-113.3
1 kHz	-136.6	-137.2	-138.4
10 kHz	-147.6	-146.6	-148.5
100 kHz	-156.3	-156.2	-154.0
800 kHz	-159.4	-159.2	-156.6
1 MHz	-159.0	-159.3	-156.7
10 MHz	-157.2	-158.7	-156.9
20 MHz	-158.1	-159.4	-157.0
<b>RMS Jitter (fs)</b> 10 kHz to 20 MHz	107.1	92.4	119.1
<b>RMS Jitter (fs)</b> 100 Hz to 20 MHz	111.6	98.1	123.3



# Appendix C: Schematics

## Power Supplies

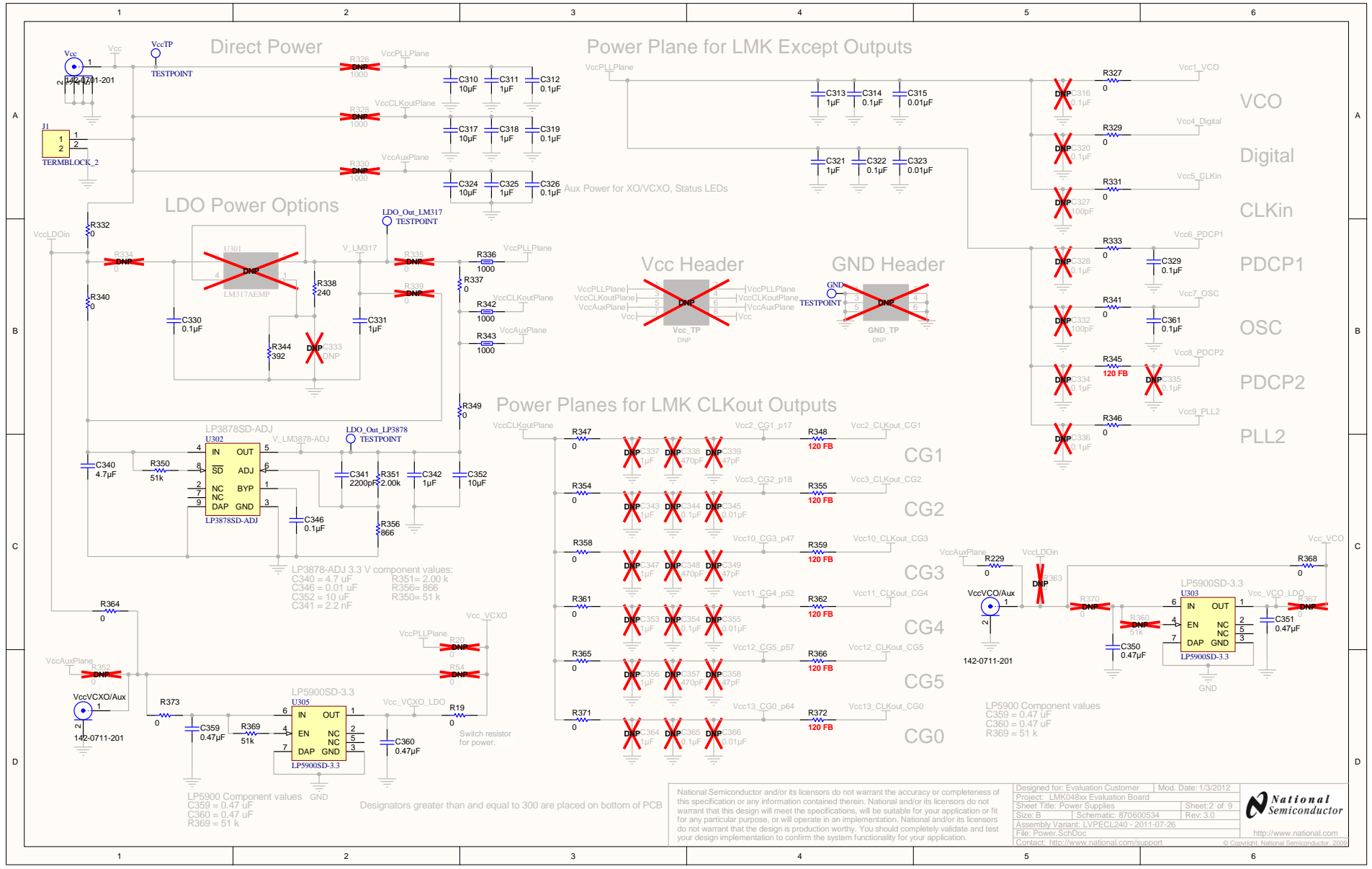

## LMK048xxB Device with Loop Filter and Crystal Circuits

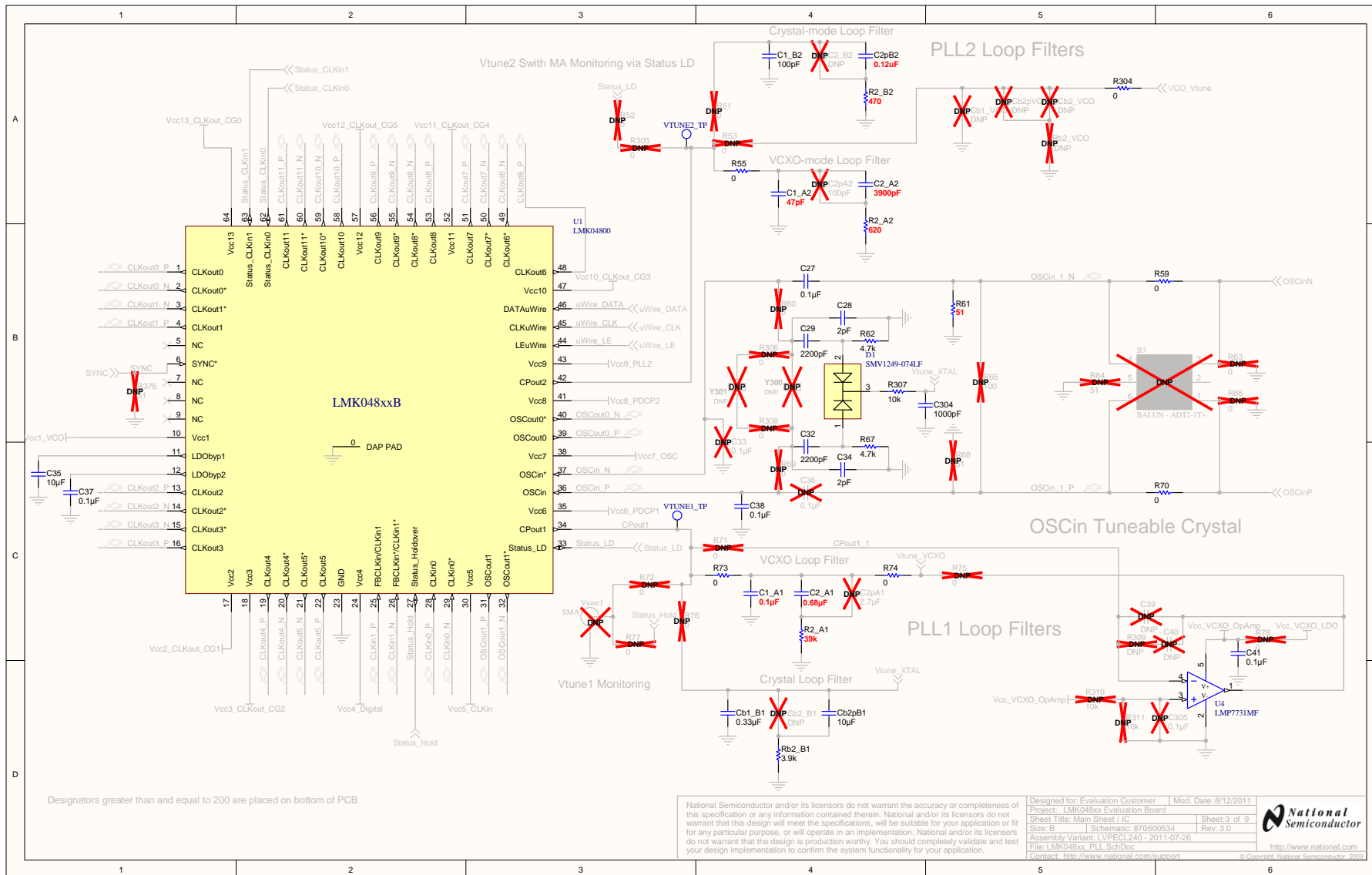

## Reference Inputs (CLKin0 & CLKin1), External VCXO (OSCin) & VCO Circuits, and OSCout1 Output

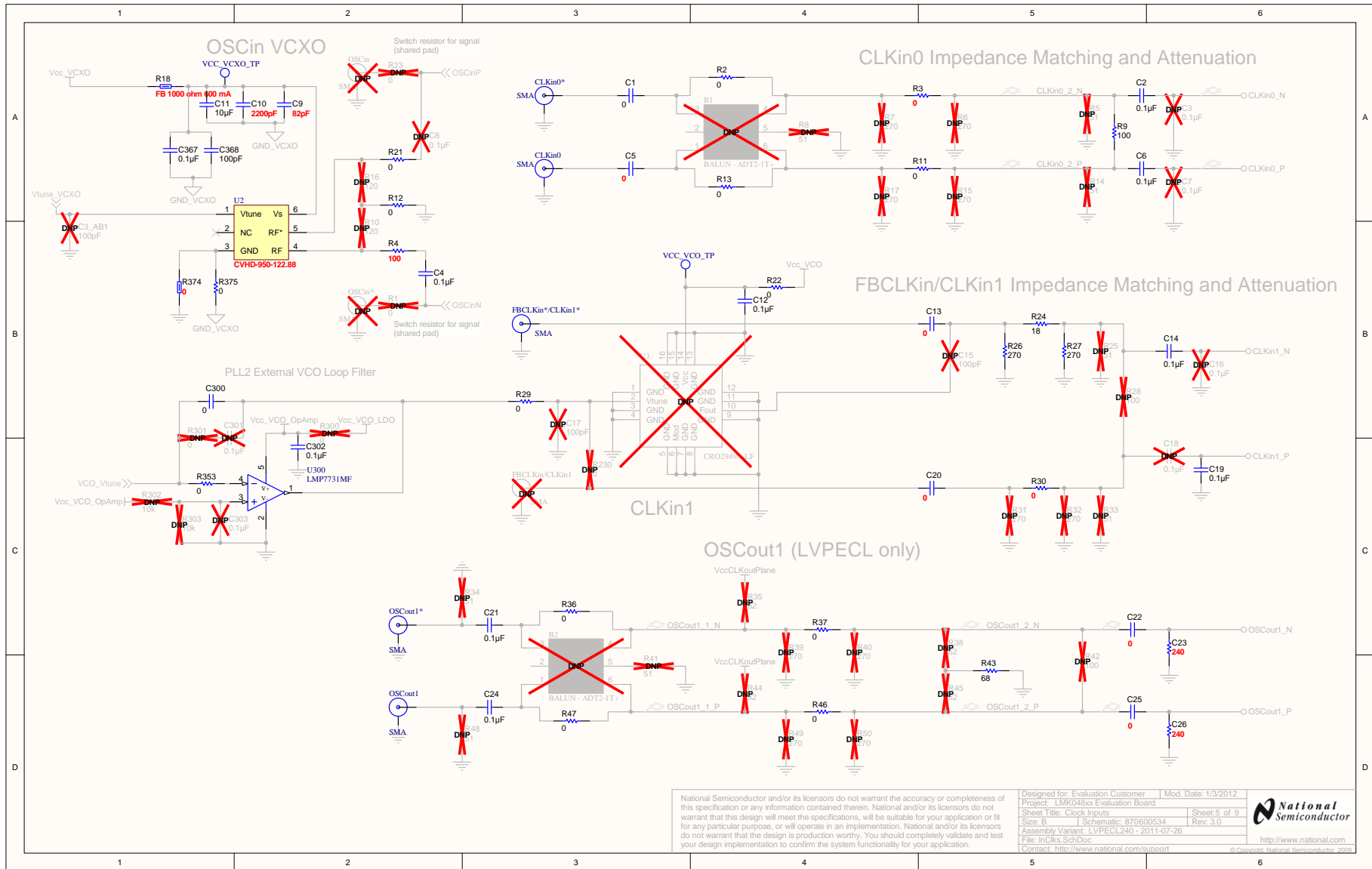

## Clock Outputs (OSCout0, CLKout0 to CLKout3)

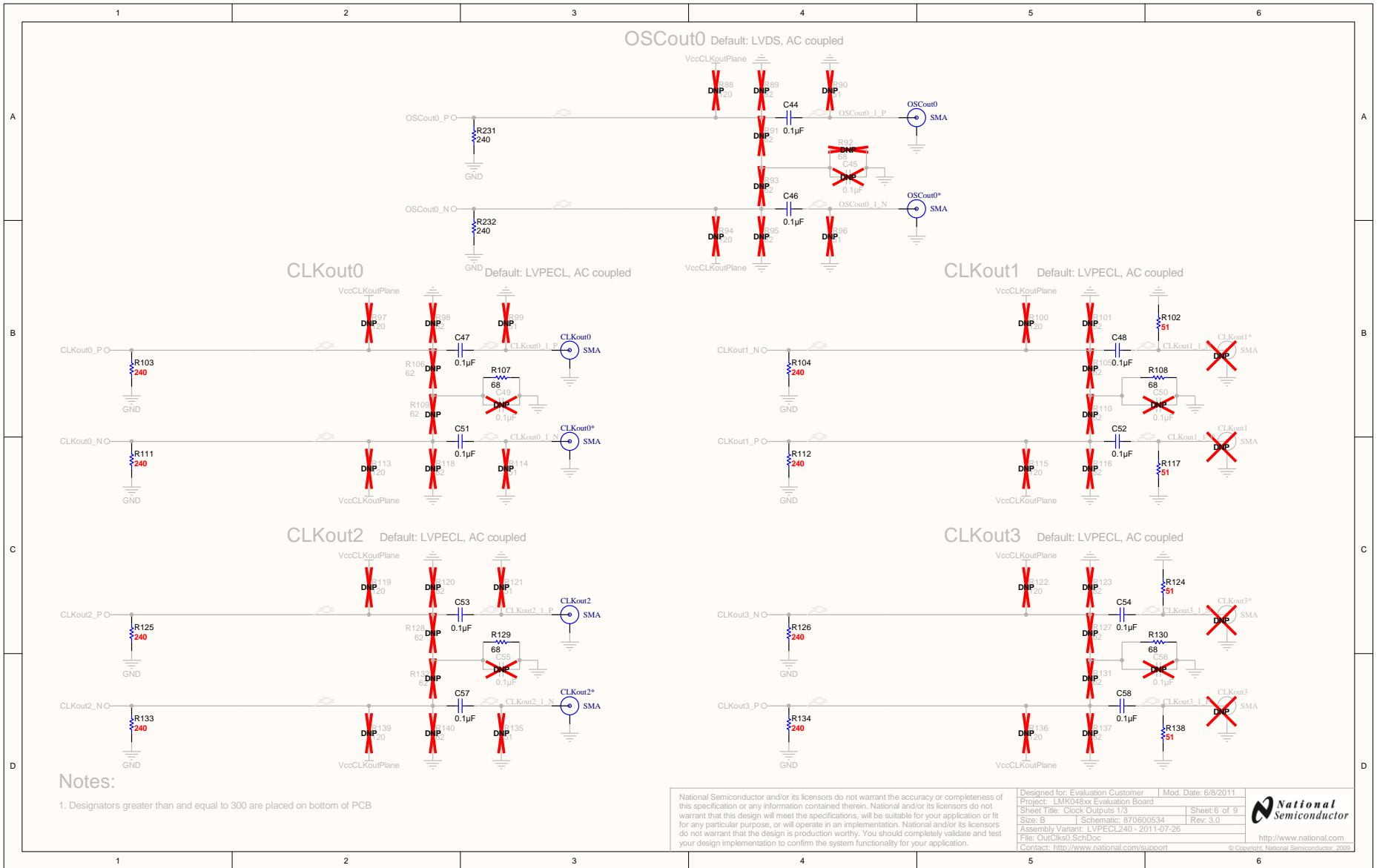

## Clock Outputs (CLKout4 to CLKout7)

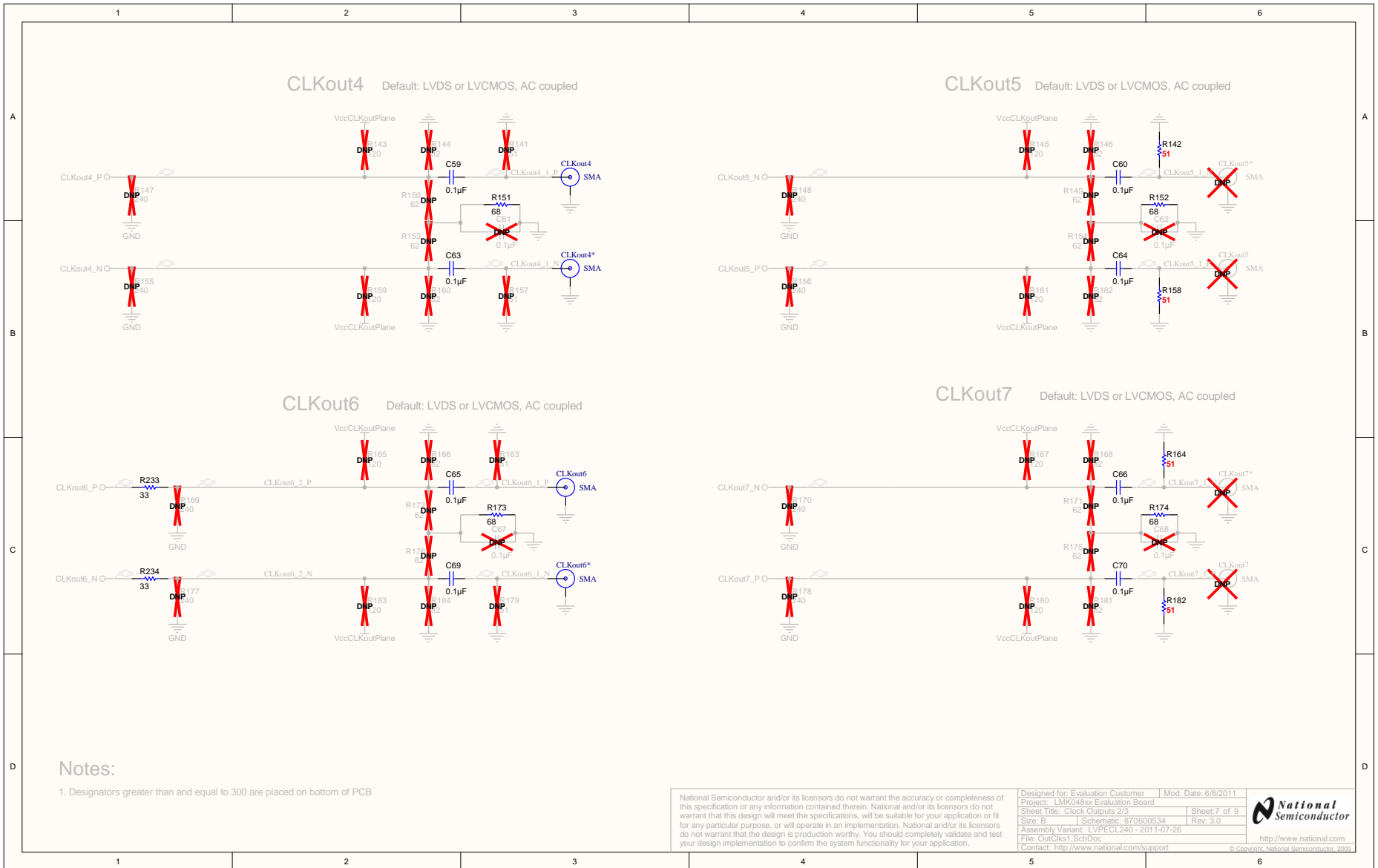

National Semiconductor and/or its licensors do not warrant the accuracy or completeness of this specification or any information contained therein. National and/or its licensors do not warrant that this design will meet the specifications, will be suitable for your application or fit for any particular purpose, or will operate in an implementation. National and/or its licensors do not warrant that the design is production worthy. You should completely validate and test your design implementation to confirm the system functionality for your application.

Designed for: Evaluation Customer | Mod. Date: 6/8/2011  
 Project: LMK048xx Evaluation Board  
 Sheet Title: Clock Outputs 2/3 | Sheet 7 of 9  
 Size: B | Schematic: 870600534 | Rev. 3.0  
 Assembly Variant: LVPECL240 - 2011-07-26  
 File: OutClks1.SchDoc  
 Contact: <http://www.national.com/support>



## Clock Outputs (CLKout8 to CLKout11)

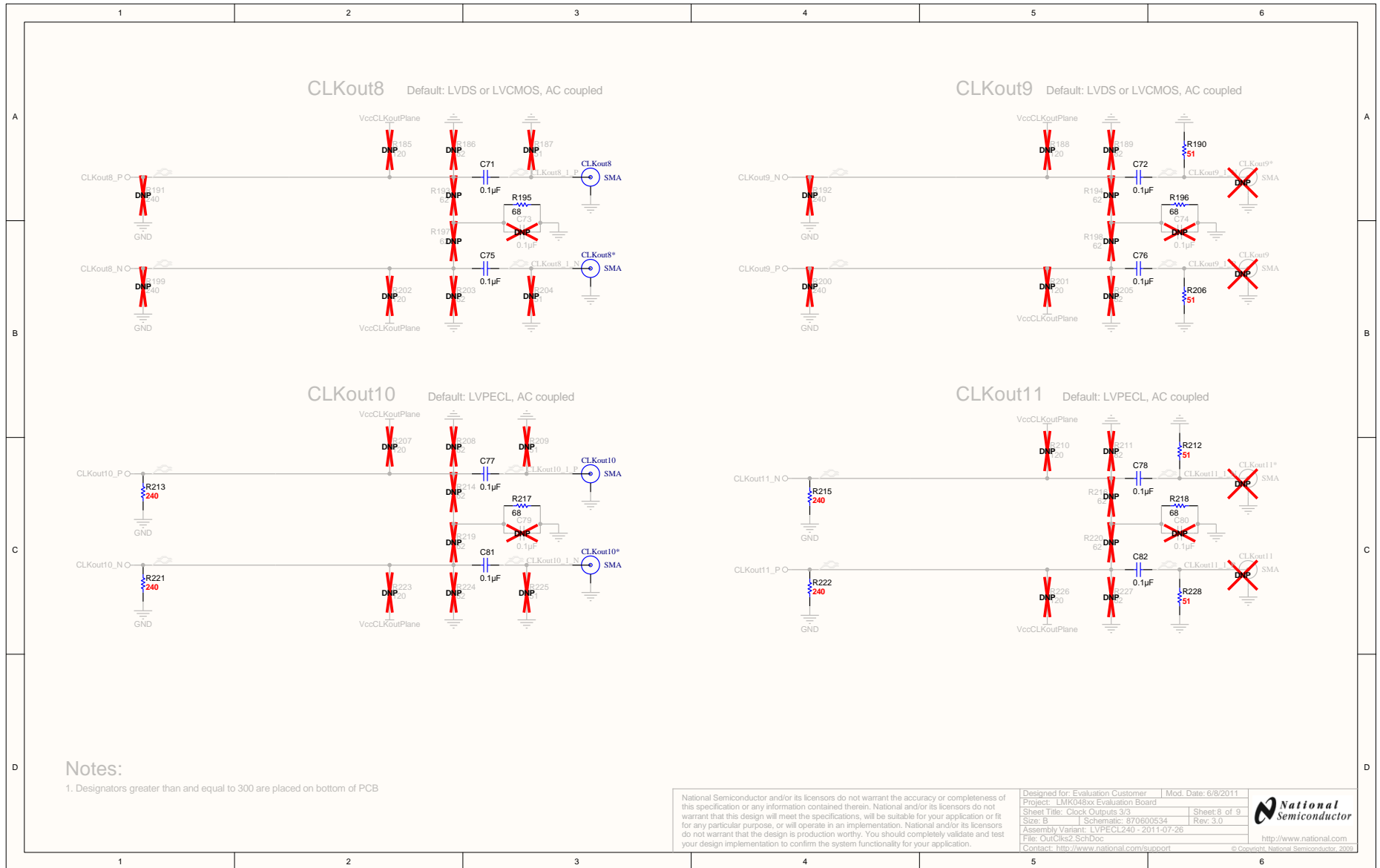

## uWire Header, Logic I/O Ports and Status LEDs

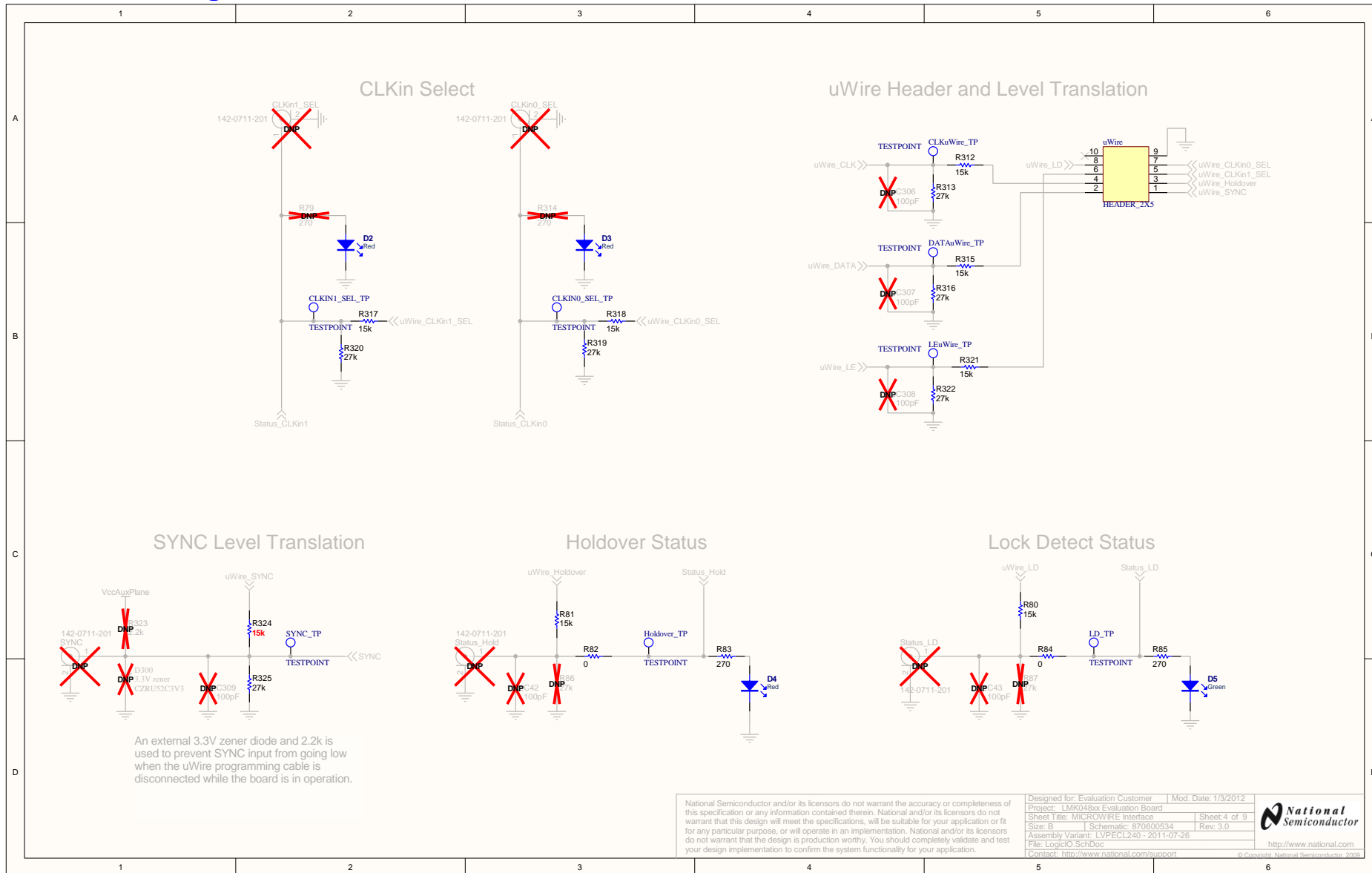

## USB Interface

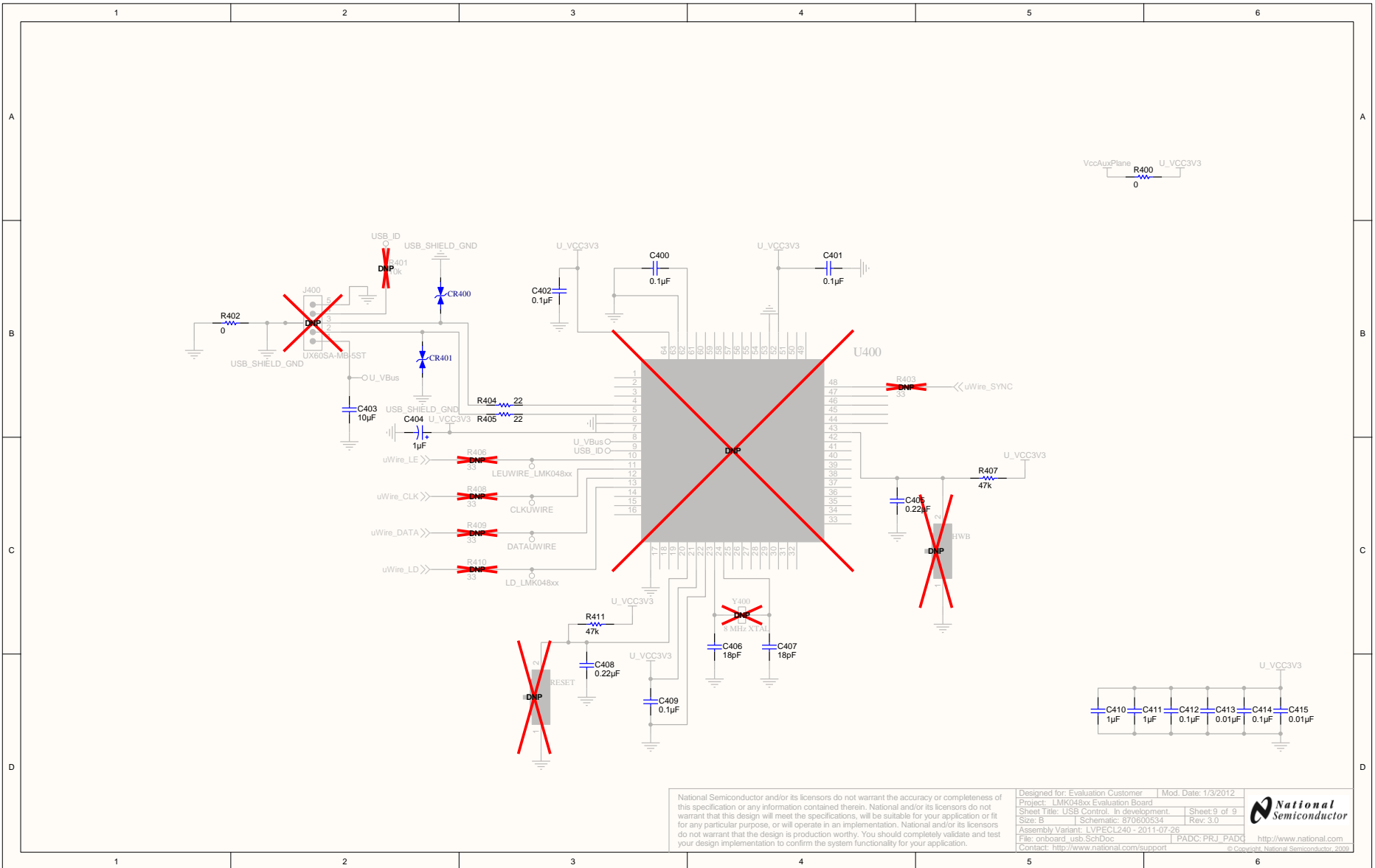

National Semiconductor and/or its licensors do not warrant the accuracy or completeness of this specification or any information contained therein. National and/or its licensors do not warrant that this design will meet the specifications, will be suitable for your application or fit for any particular purpose, or will operate in an implementation. National and/or its licensors do not warrant that the design is production worthy. You should completely validate and test your design implementation to confirm the system functionality for your application.

Designed for: Evaluation Customer	Mod. Date: 1/3/2012
Project: LMK048xx Evaluation Board	
Sheet Title: USB Control, In development	Sheet: 9 of 9
Size: B	Schematic: 870600534 Rev: 3.0
Assembly Variant: LVPECL240 - 2011-07-28	
File: ehoboard_usb.SchDoc	PADC: PRJ_PADQ
Contact: <a href="http://www.national.com/support">http://www.national.com/support</a>	<a href="http://www.national.com">http://www.national.com</a>

© Copyright, National Semiconductor, 2009



## Appendix D: Bill of Materials

Table 23: Bill of Materials for LMK048xx Evaluation Boards

Item	Designator	Description	Manufacturer	PartNumber	Quantity
1	C1, C5, C13, C20, C22, C25, C300, R3, R11, R12, R19, R21, R22, R29, R30, R37, R46, R55, R73, R74, R82, R84, R229, R304, R327, R329, R331, R333, R337, R340, R341, R346, R347, R349, R353, R354, R358, R361, R364, R365, R368, R371, R373, R374, R375, R400, R402	FB, 120 ohm, 500 mA, 0603, RES, 0 ohm, 5%, 0.1W, 0603	Vishay-Dale, Vishey/Dale	CRCW06030000Z0EA	47
2	C1_A1, C6, C14, C19, C21, C24, C27, C37, C38, C44, C46, C47, C48, C51, C52, C53, C54, C57, C58, C59, C60, C63, C64, C65, C66, C70, C71, C72, C75, C76, C77, C78, C81, C82, C312, C319, C329, C361	CAP, CERM, 0.1uF, 25V, +/-5%, X7R, 0603	Kemet	C0603C104J3RACTU	38
3	C1_A2	CAP, CERM, 47pF, 50V, +/-5%, C0G/NP0, 0603	Kemet	C0603C470J5GACTU	1
4	C1_B2	CAP, CERM, 150pF, 50V, +/-5%, C0G/NP0, 0603	Kemet	C0603C151J5GACTU	1

5	C2, C12, C41, C302, C330, C346	CAP, CERM, 0.1uF, 16V, +/-10%, X7R, 0603	Kemet	C0603C104K4RACTU	6
6	C2pB2	CAP, CERM, 0.12uF, 50V, +/-10%, X7R, 0805	Kemet	C0805C124K5RACTU	1
7	C2_A1	CAP, CERM, 0.68uF, 10V, +/-10%, X5R, 0603	Kemet	C0603C684K8PAC	1
8	C2_A2	CAP, CERM, 3900pF, 50V, +/-10%, X7R, 0603	MuRata	GRM188R71H392KA01D	1
9	C4, C69, C314, C322, C326, C367, C400, C401, C402, C409, C412, C414	CAP, CERM, 0.1uF, 25V, +/-10%, X7R, 0603, CAP, CERM, 0.1uF, 25V, +/-10%, X7R, 0603	Kemet	C0603C104K3RACTU	12
10	C9	CAP, CERM, 82pF, 50V, +/-10%, C0G/NP0, 0603	Kemet	C0603C820K5GACTU	1
11	C10, C29, C32, C341	CAP, CERM, 2200pF, 50V, +/-10%, X7R, 0603	Kemet	C0603C222K5RACTU	4
12	C11	CAP, CERM, 10uF, 10V, +/-20%, X5R, 0805	Kemet	C0805C106M8PACTU	1
13	C23, C26, R103, R104, R111, R112, R125, R126, R133, R134, R213, R215, R221, R222, R231, R232, R338	RES, 240 ohm, 5%, 0.1W, 0603	Vishay-Dale	CRCW0603240RJNEA	17
14	C28, C34	CAP, CERM, 2pF, 50V, +/-12.5%, C0G/NP0, 0603	Kemet	C0603C209C5GACTU	2
15	C35, C310, C317, C324, C352, Cb2pB1	CAP, CERM, 10uF, 10V, +/-10%, X5R, 0805	Kemet	C0805C106K8PACTU	6
16	C304	CAP, CERM, 1000pF, 50V, +/-5%, C0G/NP0, 0603	Kemet	C0603C102J5GACTU	1
17	C311, C313, C318, C321, C325, C331, C342	CAP, CERM, 1uF, 10V, +/-10%, X5R, 0603	Kemet	C0603C105K8PACTU	7
18	C315, C323	CAP, CERM, 0.01uF, 100V, +/-10%, X7R, 0603	Kemet	C0603C103K1RACTU	2
19	C340	CAP, CERM, 4.7uF, 10V, +/-10%, X5R, 0603	Kemet	C0603C475K8PACTU	1
20	C350, C351, C359, C360	CAP, CERM, 0.47uF, 16V, +/-10%, X7R, 0603	Kemet	C0603C474K4RACTU	4
21	C368	CAP, CERM, 100pF, 50V, +/-5%, C0G/NP0, 0603	Kemet	C0603C101J5GACTU	1
22	C403	CAP, CERM, 10uF, 6.3V, +/-10%, X5R, 0805	Kemet	C0805C106K9PAC	1
23	C404	CAP, TANT, 1uF, 20V, +/-10%, 8.4 ohm, 3216-18 SMD	Vishay-Sprague	293D105X9020A2TE3	1
24	C405, C408	CAP, CERM, 0.22uF, 16V, +/-10%, X7R, 0603	Kemet	C0603C224K4RACTU	2

25	C406, C407	CAP, CERM, 18pF, 50V, +/-5%, C0G/NP0, 0603	Kemet	C0603C180J5GACTU	2
26	C410, C411	CAP, CERM, 1uF, 16V, +/-10%, X5R, 0603	Kemet	C0603C105K4PACTU	2
27	C413, C415	CAP, CERM, 0.01uF, 50V, +/-5%, X7R, 0603	Kemet	C0603C103J5RACTU	2
28	Cb1_B1	CAP, CERM, 0.33uF, 16V, +/-10%, X7R, 0603	Kemet	C0603C334K4RACTU	1
29	CLKin0, CLKin0*, CLKout0, CLKout0*, CLKout2, CLKout2*, CLKout4, CLKout4*, CLKout6, CLKout6*, CLKout8, CLKout8*, CLKout10, CLKout10*, FBCLKin*/CLKin1*, OScout0, OScout0*, OScout1, OScout1*	Connector, SMT, End launch SMA 50 Ohm	Emerson Network Power	142-0701-851	19
30	CR400, CR401	ESD suppressor	Littelfuse Inc	PGB1010603MR	2
31	D1	Common Cathode Tuning Varactor	Skyworks	SMV1249-074LF	1
32	D2, D3, D4	LED 2.8X3.2MM 565NM RED CLR SMD	Lumex Opto/Components Inc.	SML-LX2832IC	3
33	D5	LED 2.8X3.2MM 565NM GRN CLR SMD	Lumex Opto/Components Inc.	SML-LX2832GC	1
34	J1	CONN TERM BLK PCB 5.08MM 2POS OR	Weidmuller	1594540000	1
35	R2, R13, R36, R47, R59, R70, R332	RES, 0 ohm, 5%, 0.125W, 0805	Vishay-Dale	CRCW08050000Z0EA	7
36	R2_A1	RES, 39k ohm, 5%, 0.1W, 0603	Vishay-Dale	CRCW060339K0JNEA	1
37	R2_A2	RES, 620 ohm, 5%, 0.1W, 0603	Vishay-Dale	CRCW0603620RJNEA	1
38	R2_B2	RES, 470 ohm, 5%, 0.1W, 0603	Vishay-Dale	CRCW0603470RJNEA	1
39	R4, R9	RES, 100 ohm, 5%, 0.1W, 0603	Vishay-Dale	CRCW0603100RJNEA	2
40	R18, R336, R342, R343	FB, 1000 ohm, 600 mA, 0603, Ferrite	Murata	BLM18HE102SN1D	4

41	R24	RES, 18 ohm, 5%, 0.1W, 0603	Vishay-Dale	CRCW060318R0JNEA	1
42	R26, R27, R83, R85	RES, 270 ohm, 5%, 0.1W, 0603	Vishay-Dale	CRCW0603270RJNEA	4
43	R43, R107, R108, R129, R130, R151, R152, R173, R174, R195, R196, R217, R218	RES, 68 ohm, 5%, 0.1W, 0603	Vishay-Dale	CRCW060368R0JNEA	13
44	R61, R102, R117, R124, R138, R142, R158, R164, R182, R190, R206, R212, R228	RES, 51 ohm, 5%, 0.1W, 0603	Vishay-Dale	CRCW060351R0JNEA	13
45	R62, R67	RES, 4.7k ohm, 5%, 0.1W, 0603	Vishay-Dale	CRCW06034K70JNEA	2
46	R80, R81, R312, R315, R317, R318, R321, R324	RES, 15k ohm, 5%, 0.1W, 0603	Vishay-Dale	CRCW060315K0JNEA	8
47	R233, R234	RES, 33 ohm, 5%, 0.1W, 0603	Vishay-Dale	CRCW060333R0JNEA	2
48	R307	RES, 10k ohm, 5%, 0.1W, 0603	Vishay-Dale	CRCW060310K0JNEA	1
49	R313, R316, R319, R320, R322, R325	RES, 27k ohm, 5%, 0.1W, 0603	Vishay-Dale	CRCW060327K0JNEA	6
50	R344	RES, 392 ohm, 1%, 0.1W, 0603	Vishay-Dale	CRCW0603392RFKEA	1
51	R345, R348, R355, R359, R362, R366, R372	FB, 120 ohm, 500 mA, 0603	Murata	BLM18AG121SN1D	7
52	R350, R369	RES, 51k ohm, 5%, 0.1W, 0603	Vishay-Dale	CRCW060351K0JNEA	2
53	R351	RES, 2.00k ohm, 1%, 0.1W, 0603	Vishay-Dale	CRCW06032K00FKEA	1
54	R356	RES, 866 ohm, 1%, 0.1W, 0603	Vishay-Dale	CRCW0603866RFKEA	1
55	R404, R405	RES, 22 ohm, 5%, 0.125W, 0805	Vishay-Dale	CRCW080522R0JNEA	2
56	R407, R411	RES, 47k ohm, 5%, 0.1W, 0603	Vishay-Dale	CRCW060347K0JNEA	2
57	Rb2_B1	RES, 3.9k ohm, 5%, 0.1W, 0603	Vishay-Dale	CRCW06033K90JNEA	1
58	S1, S2, S3, S4, S5, S6	0.875" Standoff	VOLTRIX	SPCS-14	6
59	U1	LMK04800	National Semiconductor	LMK048xxBISQ	1
60	U2	122.88 MHz VCXO	Crystek	CVHD-950-122.88	1

61	U4, U300	Precison Single Low Noise, Low 1/F corner Op Amp	National Semiconductor	LMP7731MF	2
62	U302	Micropower 800mA Low Noise 'Ceramic Stable' Adjustable Voltage Regulator for 1V to 5V Applications	National Semiconductor	LP3878SD-ADJ	1
63	U303, U305	Ultra Low Noise, 150mA Linear Regulator for RF/Analog Circuits Requires No Bypass Capacitor	National Semiconductor	LP5900SD-3.3	2
64	uWire	Low Profile Vertical Header 2x5 0.100"	FCI	52601-G10-8LF	1
65	Vcc	Connector, TH, SMA	Emerson Network Power	142-0701-201	1
66	VccVCO/Aux, VccVCXO/Aux	Connector, SMA Jack, Vertical, Gold, SMD	Emerson Network Power Connectivity	142-0711-201	2
<b><u>Unpopulated Components</u></b>					
67	B1, B2, B3	ADT2-1T Balun	MiniCircuits	ADT2-1T+	0
68	C2pA1	CAP, CERM, 2.7uF, 10V, +/-10%, X5R, 0805	Kemet	C0805C275K8PACTU	0
69	C2pA2, C3_AB1, C15, C17, C42, C43, C306, C307, C308, C309	CAP, CERM, 100pF, 50V, +/-5%, C0G/NP0, 0603	Kemet	C0603C101J5GACTU	0
70	C2_B2	CAP, CERM, 6800pF, 100V, +/-10%, X7R, 0603	Kemet	C0603C682K1RACTU	0
71	C3, C36, C335	CAP, CERM, 0.1uF, 25V, +/-5%, X7R, 0603	Kemet	C0603C104J3RACTU	0
72	C7, C8, C16, C18, C33, C45, C49, C50, C55, C56, C61, C62, C67, C68, C73, C74, C79, C80, C301, C303, C305	CAP, CERM, 0.1uF, 16V, +/-10%, X7R, 0603	Kemet	C0603C104K4RACTU	0
73	C39, C40, C333, Cb1_VCO, Cb2_B1, Cb2_VCO, Cb2pVCO	Technology, Dielectric, xxV, xx%		DNP_CAP	0
74	C316, C320, C327, C328, C332, C334, C336	CAP, CERM, 0.1uF, 16V, +/-5%, X7R, 0603	Kemet	C0603C104J4RACTU	0
75	C337, C343, C347, C353, C356, C364	CAP, CERM, 1uF, 10V, +/-10%, X5R, 0603	Kemet	C0603C105K8PACTU	0

76	C338, C344, C348, C354, C357, C365	CAP, CERM, 0.1uF, 25V, +/-10%, X7R, 0603	Kemet	C0603C104K3RACTU	0
77	C339, C345, C349, C355, C358, C366	CAP, CERM, 0.01uF, 100V, +/-10%, X7R, 0603	Kemet	C0603C103K1RACTU	0
78	CLKin0_SEL, CLKin1_SEL, Status_Hold, Status_LD, SYNC	Connector, SMA Jack, Vertical, Gold, SMD	Emerson Network Power Connectivity	142-0711-201	0
79	CLKout1, CLKout1*, CLKout3, CLKout3*, CLKout5, CLKout5*, CLKout7, CLKout7*, CLKout9, CLKout9*, CLKout11, CLKout11*, FBCLKin/CLKin1, OSCin, OSCin*, Vtune1	Connector, SMT, End launch SMA 50 Ohm	Emerson Network Power	142-0701-851	0
80	D300	Diode, Zener, 3.3V, 150mW, SOD-523F	Comchip Technology	CZRU52C3V3	0
81	GND_TP, Vcc_TP			DNP_TP	0
82	HWB, RESET		APEM Components, LLC	ADTSM31NV	0
83	J400	CONN RCPT MINI USB2.0 5POS SMD	Hirose Electric Co. Ltd.	UX60SA-MB-5ST	0

84	R1, R20, R23, R51, R52, R53, R54, R60, R63, R66, R69, R71, R72, R75, R76, R77, R78, R230, R300, R301, R305, R306, R308, R335, R339, R352, R363, R367, R370	RES, 0 ohm, 5%, 0.1W, 0603	Vishay-Dale	CRCW06030000Z0EA	0
85	R5, R8, R14, R25, R33, R34, R41, R48, R64, R68, R90, R96, R99, R114, R121, R135, R141, R157, R163, R179, R187, R204, R209, R225, R376	RES, 51 ohm, 5%, 0.1W, 0603	Vishay-Dale	CRCW060351R0JNEA	0
86	R6, R7, R15, R17, R31, R32, R39, R40, R49, R50, R79, R314	RES, 270 ohm, 5%, 0.1W, 0603	Vishay-Dale	CRCW0603270RJNEA	0
87	R10, R16, R88, R94, R97, R100, R113, R115, R119, R122, R136, R139, R143, R145, R159, R161, R165, R167, R180, R183, R185, R188, R201, R202, R207, R210, R223, R226	RES, 120 ohm, 5%, 0.1W, 0603	Vishay-Dale	CRCW0603120RJNEA	0

88	R28, R42, R65	RES, 100 ohm, 5%, 0.1W, 0603	Vishay-Dale	CRCW0603100RJNEA	0
89	R35, R44, R89, R95, R98, R101, R116, R118, R120, R123, R137, R140, R144, R146, R160, R162, R166, R168, R181, R184, R186, R189, R203, R205, R208, R211, R224, R227	RES, 82 ohm, 5%, 0.1W, 0603	Vishay-Dale	CRCW060382R0JNEA	0
90	R38, R45, R91, R93, R105, R106, R109, R110, R127, R128, R131, R132, R149, R150, R153, R154, R171, R172, R175, R176, R193, R194, R197, R198, R214, R216, R219, R220	RES, 62 ohm, 5%, 0.1W, 0603	Vishay-Dale	CRCW060362R0JNEA	0
91	R86, R87	RES, 27k ohm, 5%, 0.1W, 0603	Vishay-Dale	CRCW060327K0JNEA	0
92	R92	RES, 68 ohm, 5%, 0.1W, 0603	Vishay-Dale	CRCW060368R0JNEA	0
93	R147, R148, R155, R156, R169, R170, R177, R178, R191, R192, R199, R200	RES, 240 ohm, 5%, 0.1W, 0603	Vishay-Dale	CRCW0603240RJNEA	0
94	R302, R303, R310, R311, R401	RES, 10k ohm, 5%, 0.1W, 0603	Vishay-Dale	CRCW060310K0JNEA	0
95	R309, Rb2_VCO	x%, x.xxxW		DNP_RES	0



96	R323	RES, 2.2k ohm, 5%, 0.1W, 0603	Vishay-Dale	CRCW06032K20JNEA	0
97	R326, R328, R330	FB, 1000 ohm, 600 mA, 0603	Murata	BLM18HE102SN1D	0
98	R334	RES, 0 ohm, 5%, 0.125W, 0805	Vishay-Dale	CRCW08050000Z0EA	0
99	R360	RES, 51k ohm, 5%, 0.1W, 0603	Vishay-Dale	CRCW060351K0JNEA	0
100	R403, R406, R408, R409, R410	RES, 33 ohm, 5%, 0.1W, 0603	Vishay-Dale	CRCW060333R0JNEA	0
101	U3	VCO		CRO2949A-LF	0
102	U301	3-Terminal Adjustable Regulator	National Semiconductor	LM317AEMP	0
103	U400, Y400				0
104	Y300, Y301			DNP_XTAL	0

## Appendix E: PCB Layers Stackup

6-layer PCB Stackup includes:

- Top Layer for high-priority high-frequency signals (2 oz.)
- RO4003 Dielectric, 16 mils
- RF Ground plane (1 oz.)
- FR4, 4 mils
- Power plane #1 (1 oz.)
- FR4, 12.6 mils
- Ground plane (1 oz.)
- FR4, 8 mils
- Power Plane #2 (1 oz.)
- FR4, 12 mils
- Bottom Layer copper clad for thermal relief (2 oz.)

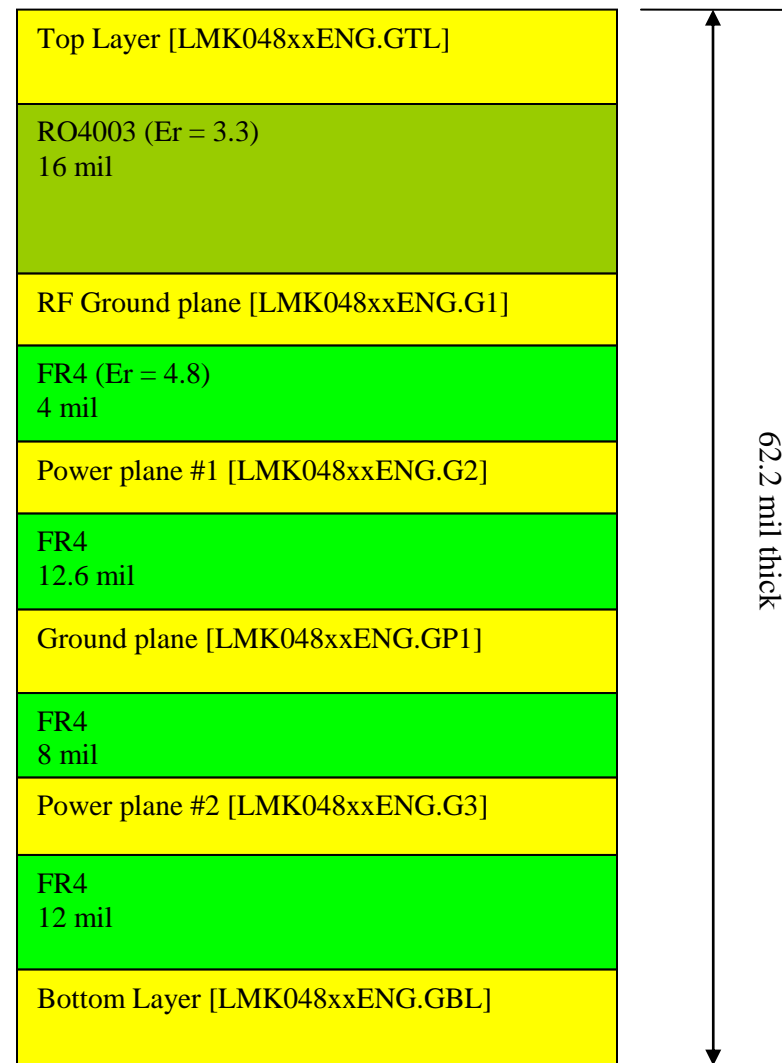

# Appendix F: PCB Layout

## Layer #1 – Top

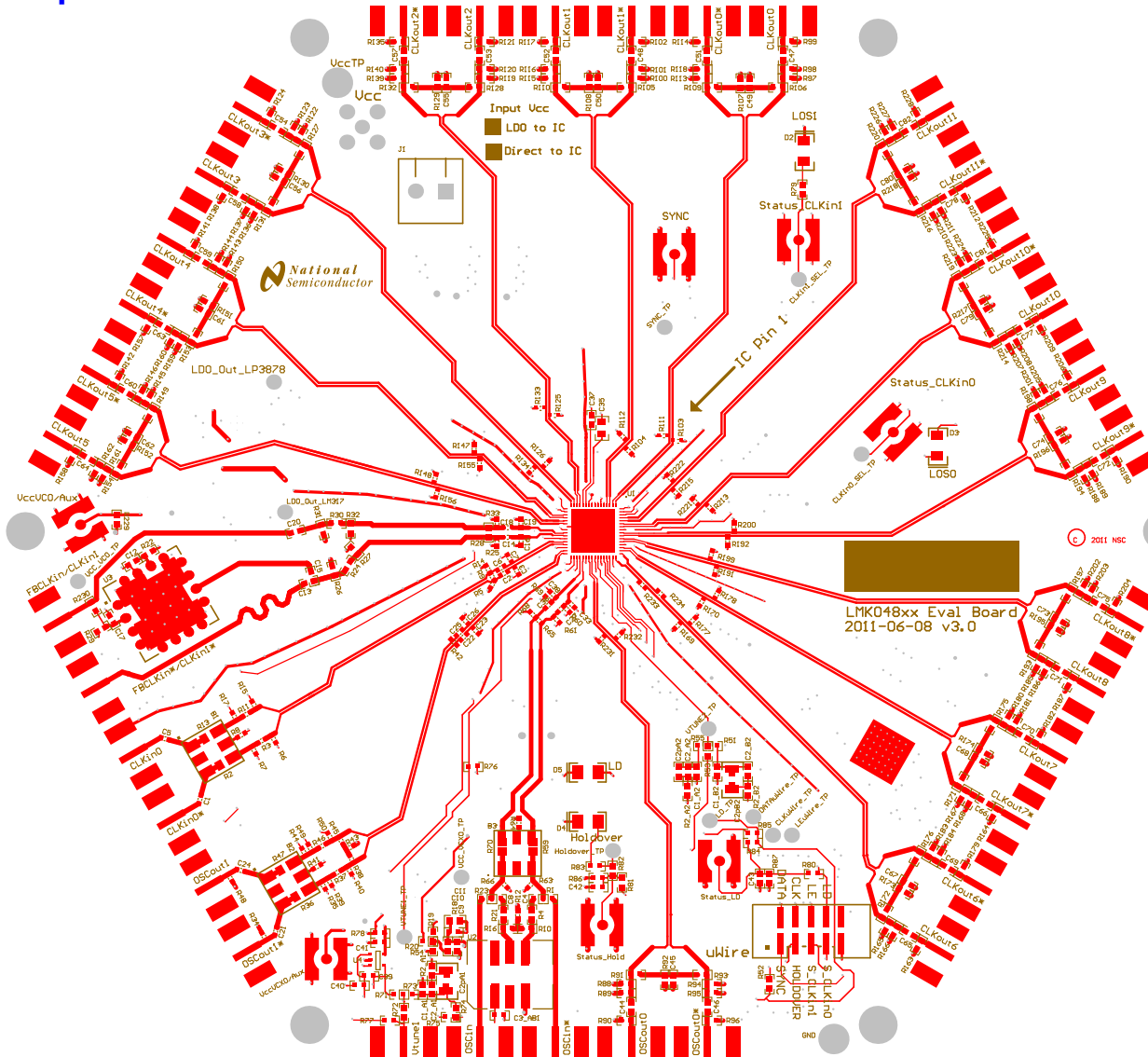

## Layer #2 – RF Ground Plane (Inverted)

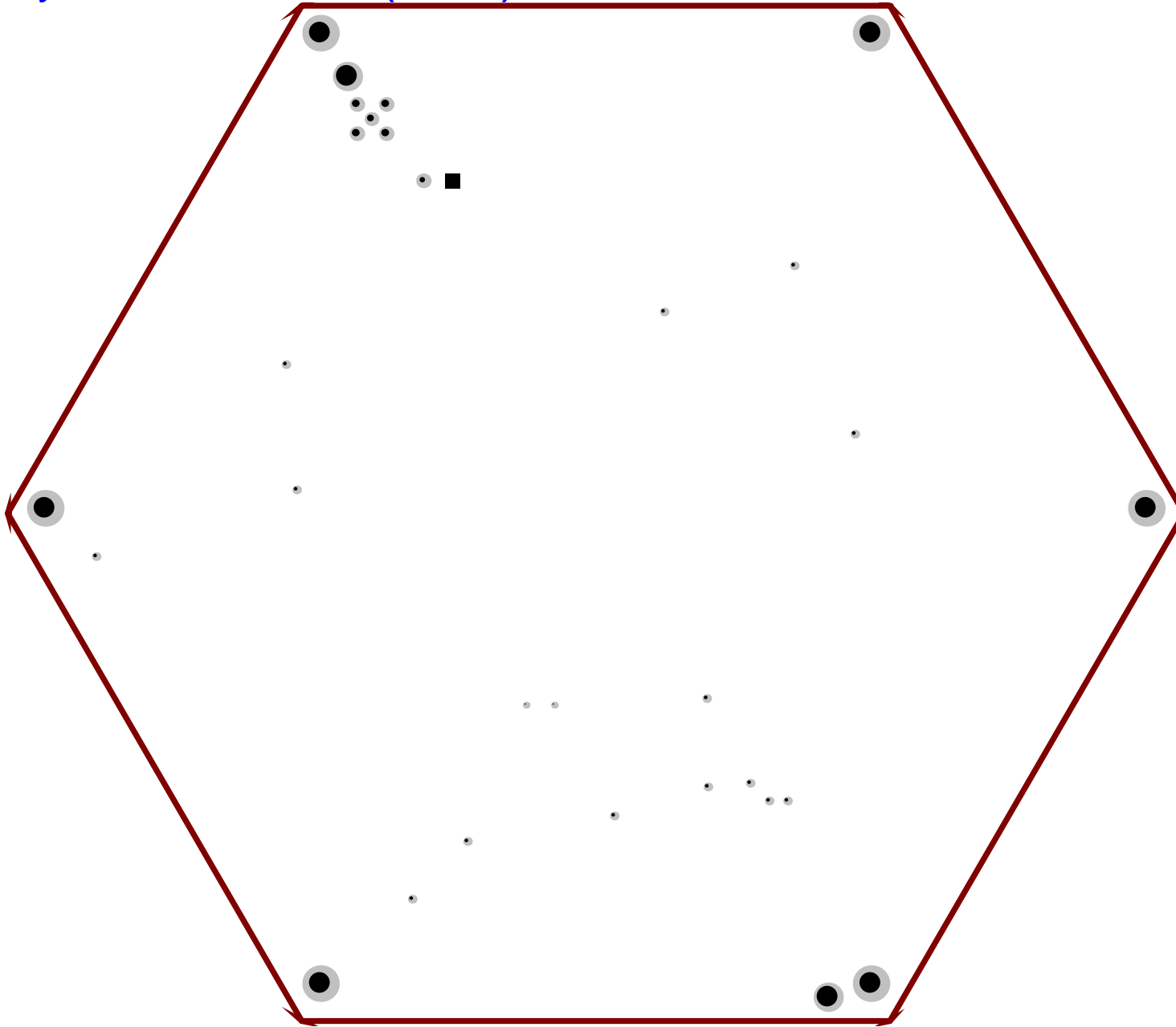

## Layer #3 – Vcc Planes

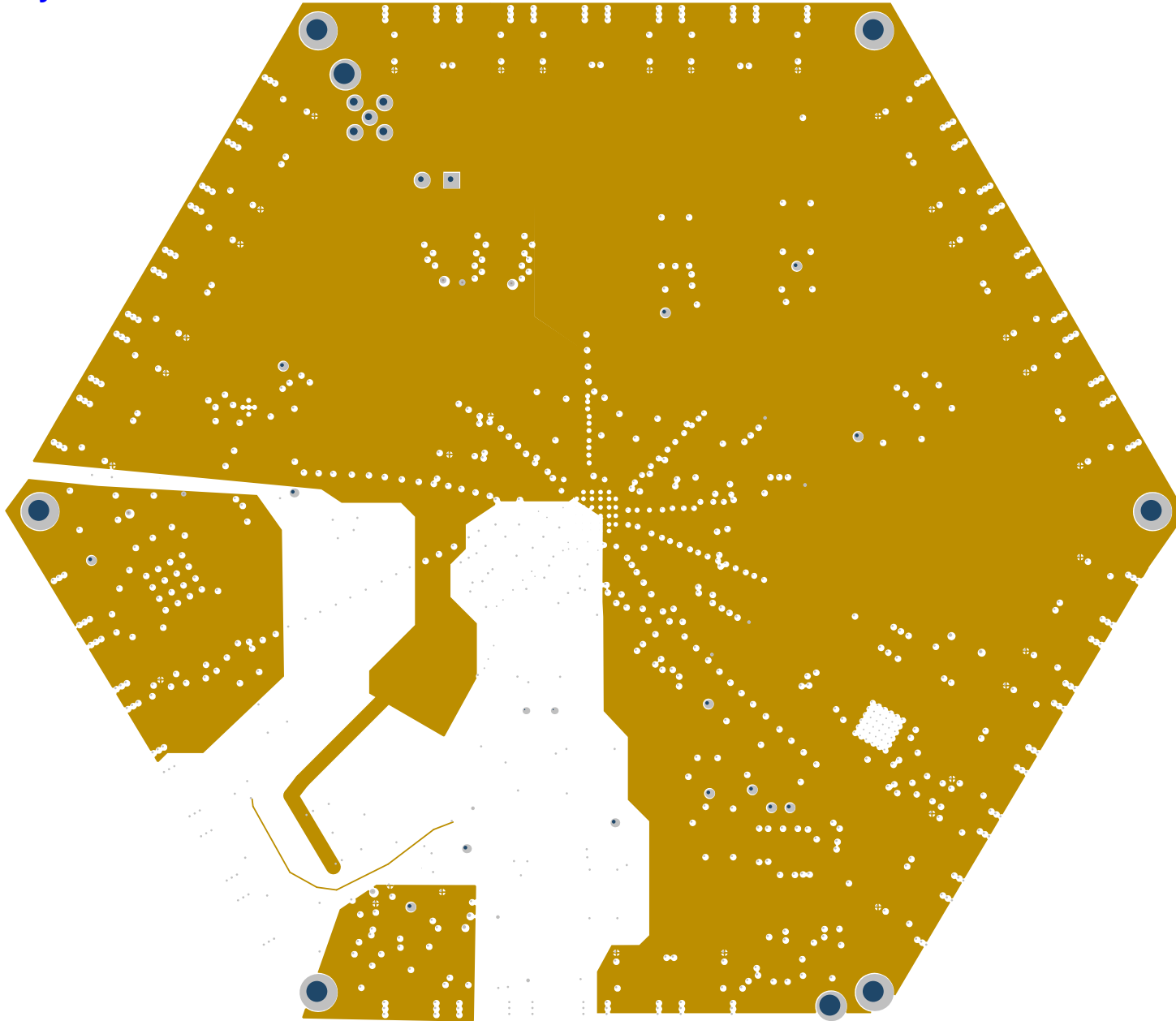

### Layer #4 – Ground Plane (Inverted)

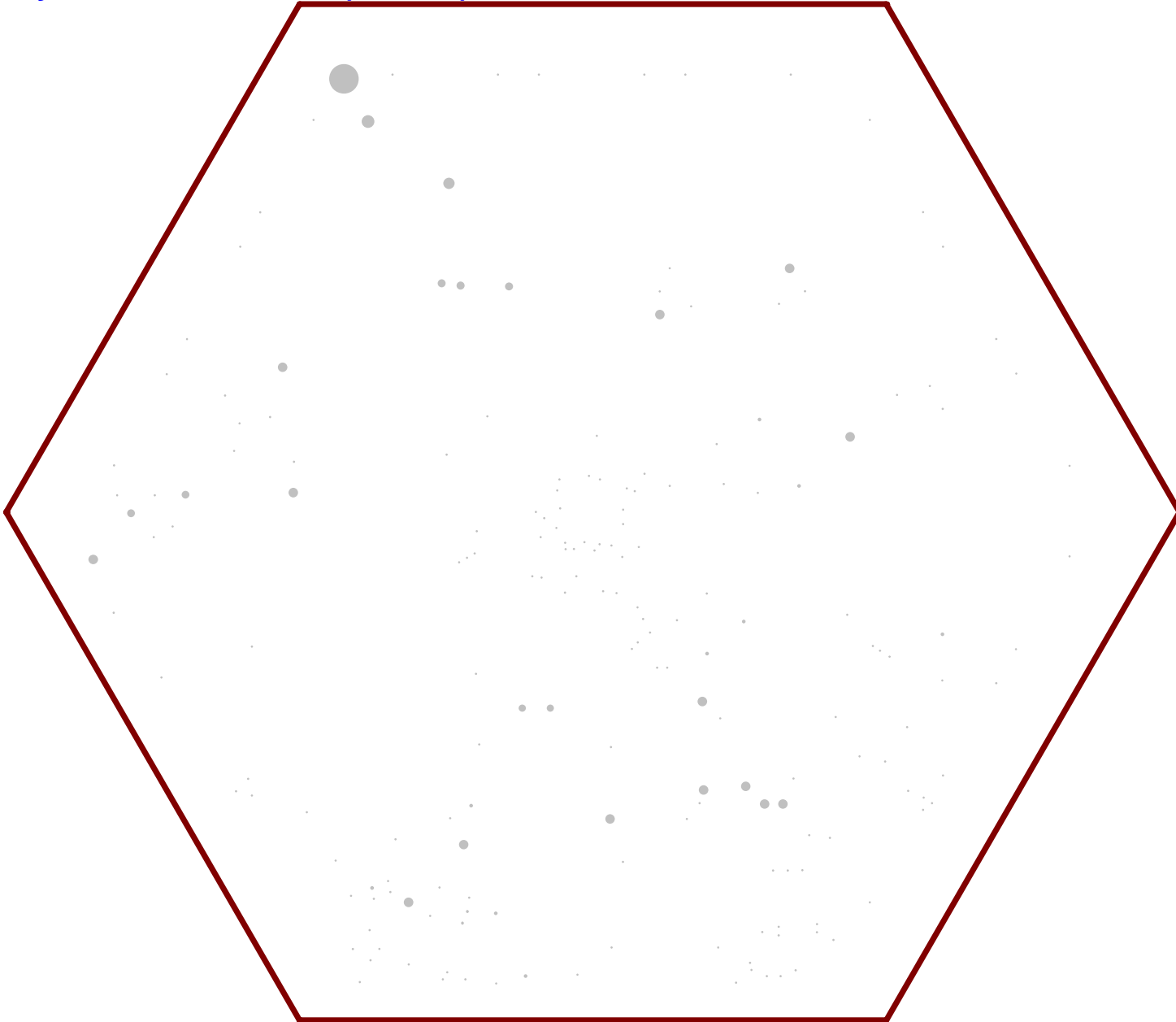

## Layer # 5 – Vcc Planes 2







## Layers #1 and 6 – Top and Bottom (Composite)

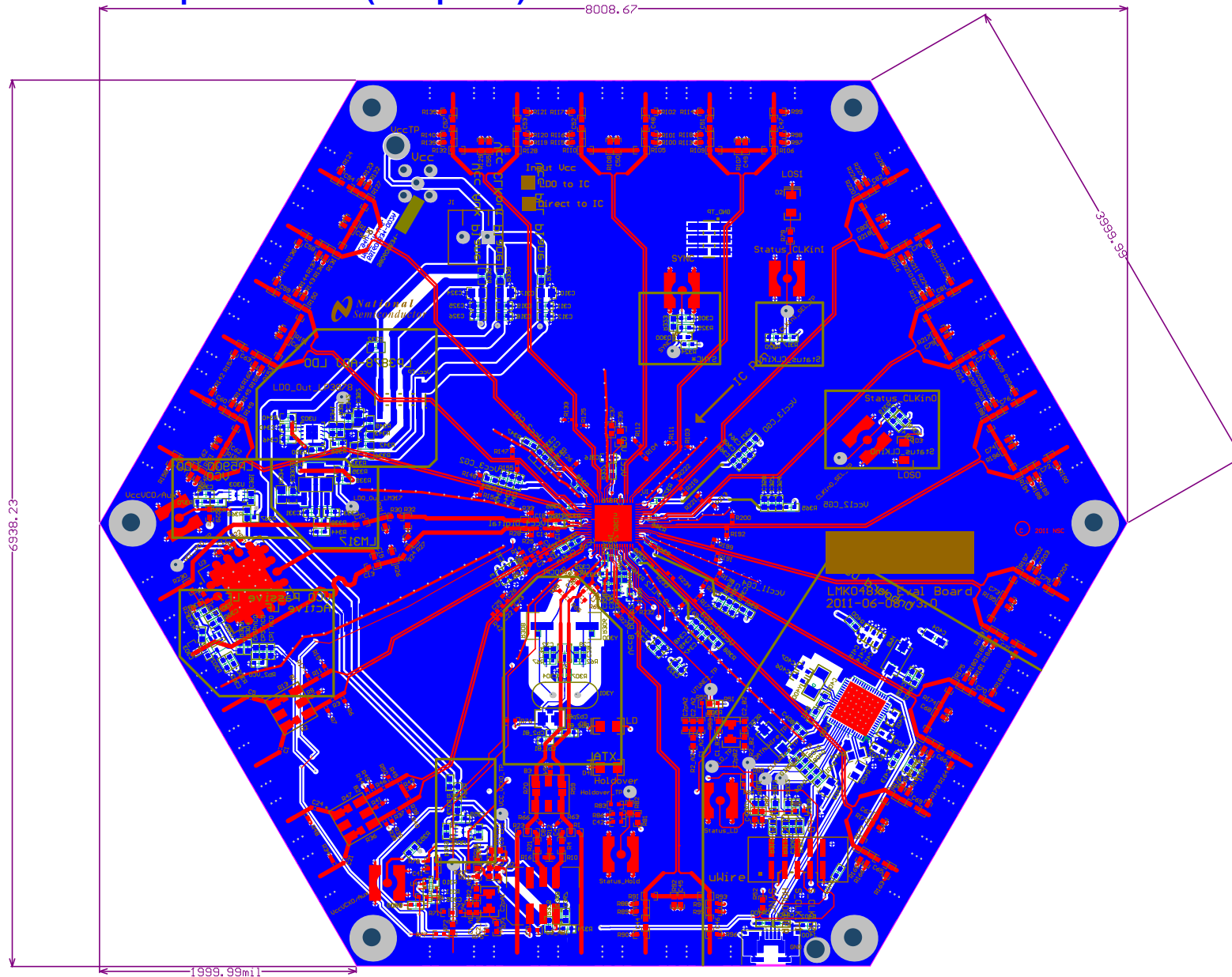

## Appendix G: Properly Configuring LPT Port

When trying to solve any communications issue, it is most convenient to verify communication by programming the POWERDOWN bit to confirm normal or low supply current consumption of the evaluation board.

### LPT Driver Loading

The parallel port must be configured for proper operation. To confirm that the LPT port driver is successfully loading click “LPT/USB” → “Check LPT.” If the driver properly loads then the following message is displayed:

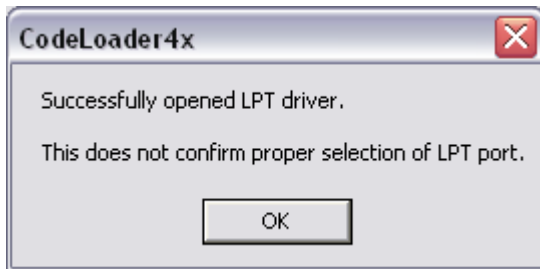

Figure 22: Successfully Opened LPT Driver

*Successful loading of LPT driver does not mean LPT communications in CodeLoader are setup properly. The proper LPT port must be selected and the LPT port must not be in an improper mode.*

The PC must be rebooted after install for LPT support to work properly.

### Correct LPT Port/Address

To determine the correct LPT port in Windows, open the device manager (On Windows XP, Start → Settings → Control Panel → System → Hardware tab → Device Manager) and check the LPT port under the Ports (COM & LPT) node of the tree. It can be helpful to confirm that the LPT port is mapped to the expected port address, for instance to confirm that LPT1 is really mapped to address 0x378. This can be checked by viewing the Properties of the LPT1 port and viewing Resources tab to verify that the I/O Range starts at 0x378. CodeLoader expects the traditional port mapping:

Port	Address
LPT1	0x378
LPT2	0x278
LPT3	0x3BC

If a non-standard address is used, use the “Other” port address in CodeLoader and type in the port address in hexadecimal. It is possible to change the port address in the computer’s BIOS settings. The port address can be set in CodeLoader in the Port Setup tab as shown in Figure 23.

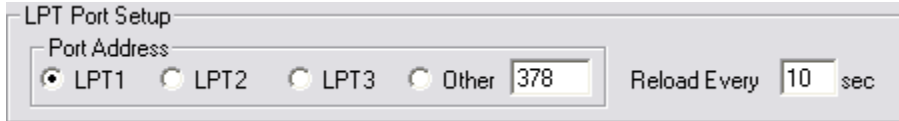

Figure 23: Selecting the LPT Port Address

### Correct LPT Mode

If communications are not working, then it is possible the LPT port mode is set improperly. It is recommended to use the simple, Output-only mode of the LPT port. This can be set in the BIOS of the computer. Common terms for this desired parallel port mode are “Normal,” “Output,” or “AT.” It is possible to enter BIOS setup during the initial boot up sequence of the computer.



## Appendix H: Troubleshooting Information

If the evaluation board is not behaving as expected, the most likely issues are...

- 1) Board communication issue
- 2) Incorrect Programming of the device
- 3) Setup Error

Refer to this checklist for a practical guide on identifying/exposing possible issues.

### 1) Confirm Communications

Refer to Appendix G: Properly Configuring LPT Port to troubleshoot this item.

Remember to load device with Ctrl+L.

### 2) Confirm PLL1 operation/locking

- 1) Program LD\_MUX = "PLL1\_R/2"
- 2) Confirm that LD pin output is half the expected phase detector frequency of PLL1.
  - i. If not, examine CLKin\_SEL programming.
  - ii. If not, examine CLKin0\_BUFTYPE / CLKin1\_BUFTYPE.
  - iii. If not, examine PLL1 register R programming.
  - iv. If not, examine physical CLKin input.
- 3) Program LD\_MUX = "PLL1\_N /2"
- 4) Confirm that LD pin output is half the expected phase detector frequency of PLL1.
  - i. If not, examine PLL1 register N programming.
  - ii. If not, examine physical OSCin input.

Naturally, the output frequency of the above two items, PLL 1 R Divider/2 and PLL 1 N Divider /2, on LD pin should be the same frequency.

- 5) Program LD\_MUX = "PLL1\_DLD"
- 6) Confirm the LD pin output is high.
  - i. If high, then PLL1 is locked, continue to PLL2 operation/locking.
- 7) If LD pin output is low, but the frequencies are the same, it is possible that excessive leakage on Vtune pin is causing the digital lock detect to not activate. By default PLL2 waits for the digital lock detect to go high before allowing PLL2 and the integrated VCO to lock. Different VCXO models have different input leakage specifications. High leakage, low PLL1 phase detector frequencies, and low PLL1 charge pump current settings can cause the PLL1 charge pump to operate longer than the digital lock detect timeout which allows the device to lock, but prevents the digital lock detect from activating.
  - i. Redesign PLL1 loop filter with higher phase detector frequency
  - ii. Redesign PLL1 loop filter with higher charge pump current
  - iii. Isolate VCXO tuning input from PLL1 charge pump with an op amp.



### 3) Confirm PLL2 operation/locking

- 1) Program LD\_MUX = "PLL2\_R/2"
- 2) Confirm that LD pin output is half the expected phase detector frequency of PLL2.
  - i. If not, examine PLL2\_R programming.
  - ii. If not, examine physical OSCin input.
- 3) Program LD\_MUX = "PLL2\_N/2"
- 4) Confirm that LD pin output is half the expected phase detector frequency of PLL2.
  - i. If not, confirm OSCin\_FREQ is programmed to OSCin frequency.
  - ii. If not, examine PLL2\_N programming.

Naturally, the output frequency of the above two items should be the same frequency.

- 5) Program LD\_MUX = "PLL2 DLD"
- 6) Confirm the LD pin output is high.
- 7) Program LD\_MUX = "PLL1 & PLL2 DLD"
- 8) Confirm the LD pin output is high.

## IMPORTANT NOTICE

Texas Instruments Incorporated and its subsidiaries (TI) reserve the right to make corrections, modifications, enhancements, improvements, and other changes to its products and services at any time and to discontinue any product or service without notice. Customers should obtain the latest relevant information before placing orders and should verify that such information is current and complete. All products are sold subject to TI's terms and conditions of sale supplied at the time of order acknowledgment.

TI warrants performance of its hardware products to the specifications applicable at the time of sale in accordance with TI's standard warranty. Testing and other quality control techniques are used to the extent TI deems necessary to support this warranty. Except where mandated by government requirements, testing of all parameters of each product is not necessarily performed.

TI assumes no liability for applications assistance or customer product design. Customers are responsible for their products and applications using TI components. To minimize the risks associated with customer products and applications, customers should provide adequate design and operating safeguards.

TI does not warrant or represent that any license, either express or implied, is granted under any TI patent right, copyright, mask work right, or other TI intellectual property right relating to any combination, machine, or process in which TI products or services are used. Information published by TI regarding third-party products or services does not constitute a license from TI to use such products or services or a warranty or endorsement thereof. Use of such information may require a license from a third party under the patents or other intellectual property of the third party, or a license from TI under the patents or other intellectual property of TI.

Reproduction of TI information in TI data books or data sheets is permissible only if reproduction is without alteration and is accompanied by all associated warranties, conditions, limitations, and notices. Reproduction of this information with alteration is an unfair and deceptive business practice. TI is not responsible or liable for such altered documentation. Information of third parties may be subject to additional restrictions.

Resale of TI products or services with statements different from or beyond the parameters stated by TI for that product or service voids all express and any implied warranties for the associated TI product or service and is an unfair and deceptive business practice. TI is not responsible or liable for any such statements.

TI products are not authorized for use in safety-critical applications (such as life support) where a failure of the TI product would reasonably be expected to cause severe personal injury or death, unless officers of the parties have executed an agreement specifically governing such use. Buyers represent that they have all necessary expertise in the safety and regulatory ramifications of their applications, and acknowledge and agree that they are solely responsible for all legal, regulatory and safety-related requirements concerning their products and any use of TI products in such safety-critical applications, notwithstanding any applications-related information or support that may be provided by TI. Further, Buyers must fully indemnify TI and its representatives against any damages arising out of the use of TI products in such safety-critical applications.

TI products are neither designed nor intended for use in military/aerospace applications or environments unless the TI products are specifically designated by TI as military-grade or "enhanced plastic." Only products designated by TI as military-grade meet military specifications. Buyers acknowledge and agree that any such use of TI products which TI has not designated as military-grade is solely at the Buyer's risk, and that they are solely responsible for compliance with all legal and regulatory requirements in connection with such use.

TI products are neither designed nor intended for use in automotive applications or environments unless the specific TI products are designated by TI as compliant with ISO/TS 16949 requirements. Buyers acknowledge and agree that, if they use any non-designated products in automotive applications, TI will not be responsible for any failure to meet such requirements.

Following are URLs where you can obtain information on other Texas Instruments products and application solutions:

### Products

Audio	<a href="http://www.ti.com/audio">www.ti.com/audio</a>
Amplifiers	<a href="http://amplifier.ti.com">amplifier.ti.com</a>
Data Converters	<a href="http://dataconverter.ti.com">dataconverter.ti.com</a>
DLP® Products	<a href="http://www.dlp.com">www.dlp.com</a>
DSP	<a href="http://dsp.ti.com">dsp.ti.com</a>
Clocks and Timers	<a href="http://www.ti.com/clocks">www.ti.com/clocks</a>
Interface	<a href="http://interface.ti.com">interface.ti.com</a>
Logic	<a href="http://logic.ti.com">logic.ti.com</a>
Power Mgmt	<a href="http://power.ti.com">power.ti.com</a>
Microcontrollers	<a href="http://microcontroller.ti.com">microcontroller.ti.com</a>
RFID	<a href="http://www.ti-rfid.com">www.ti-rfid.com</a>
OMAP Mobile Processors	<a href="http://www.ti.com/omap">www.ti.com/omap</a>
Wireless Connectivity	<a href="http://www.ti.com/wirelessconnectivity">www.ti.com/wirelessconnectivity</a>

### Applications

Automotive and Transportation	<a href="http://www.ti.com/automotive">www.ti.com/automotive</a>
Communications and Telecom	<a href="http://www.ti.com/communications">www.ti.com/communications</a>
Computers and Peripherals	<a href="http://www.ti.com/computers">www.ti.com/computers</a>
Consumer Electronics	<a href="http://www.ti.com/consumer-apps">www.ti.com/consumer-apps</a>
Energy and Lighting	<a href="http://www.ti.com/energy">www.ti.com/energy</a>
Industrial	<a href="http://www.ti.com/industrial">www.ti.com/industrial</a>
Medical	<a href="http://www.ti.com/medical">www.ti.com/medical</a>
Security	<a href="http://www.ti.com/security">www.ti.com/security</a>
Space, Avionics and Defense	<a href="http://www.ti.com/space-avionics-defense">www.ti.com/space-avionics-defense</a>
Video and Imaging	<a href="http://www.ti.com/video">www.ti.com/video</a>

TI E2E Community Home Page

[e2e.ti.com](http://e2e.ti.com)

Mailing Address: Texas Instruments, Post Office Box 655303, Dallas, Texas 75265  
Copyright © 2012, Texas Instruments Incorporated

# Mouser Electronics

Authorized Distributor

Click to View Pricing, Inventory, Delivery & Lifecycle Information:

[Texas Instruments:](#)

[LMK04803BEVAL/NOPB](#) [LMK04805BEVAL/NOPB](#) [LMK04806BEVAL/NOPB](#)