

DAC161S055 Precision 16-Bit, Buffered Voltage-Output DAC

Check for Samples: [DAC161S055](#)

FEATURES

- 16-bit DAC with a two-buffer SPI interface
- Asynchronous load DAC and reset pins
- Compatibility with 1.8V controllers
- Buffered voltage output with rail-to-rail capability
- Wide voltage reference range of +2.5V to V_A
- Wide temperature range of -40°C to $+105^{\circ}\text{C}$
- Packaged in a 16-pin LLP

APPLICATIONS

- Process control
- Automatic test equipment
- Programmable voltage sources
- Communication systems
- Data acquisition
- Industrial PLCs
- Portable battery powered instruments

DESCRIPTION

The DAC161S055 is a precision 16-bit, buffered voltage output Digital-to-Analog Converter (DAC) that operates from a 2.7V to 5.25V supply with a separate I/O supply pin that operates down to 1.7V. The on-chip precision output buffer provides rail-to-rail output swing and has a typical settling time of 5 μs . The external voltage reference can be set between 2.5V and V_A (the analog supply voltage), providing the widest dynamic output range possible.

The 4-wire SPI compatible interface operates at clock rates up to 20 MHz. The part is capable of Daisy Chain and Data Read Back. An on board power-on-reset (POR) circuit ensures the output powers up to a known state.

The DAC161S055 features a power-up value pin (MZB), a load DAC pin (LDACB) and a DAC clear (CLRB) pin. MZB sets the startup output voltage to either GND or mid-scale. LDACB updates the output, allowing multiple DACs to update their outputs simultaneously. CLRB can be used to reset the output signal to the value determined by MZB.

The DAC161S055 has a power-down option that reduces power consumption when the part is not in use. It is available in a 16-lead LLP package.

Table 1. Key Specifications

	VALUE	UNIT
Resolution (guaranteed monotonic)	16	bits
INL	± 3	LSB (max)
Very low output noise	120 nV/ $\sqrt{\text{Hz}}$ (typ)	
Glitch impulse	7 nV-s (typ)	
Output settling time	5 μs (typ)	
Power consumption	5.5 mW @ 5.25	V (max)



Please be aware that an important notice concerning availability, standard warranty, and use in critical applications of Texas Instruments semiconductor products and disclaimers thereto appears at the end of this data sheet.

All trademarks are the property of their respective owners.

Block Diagram

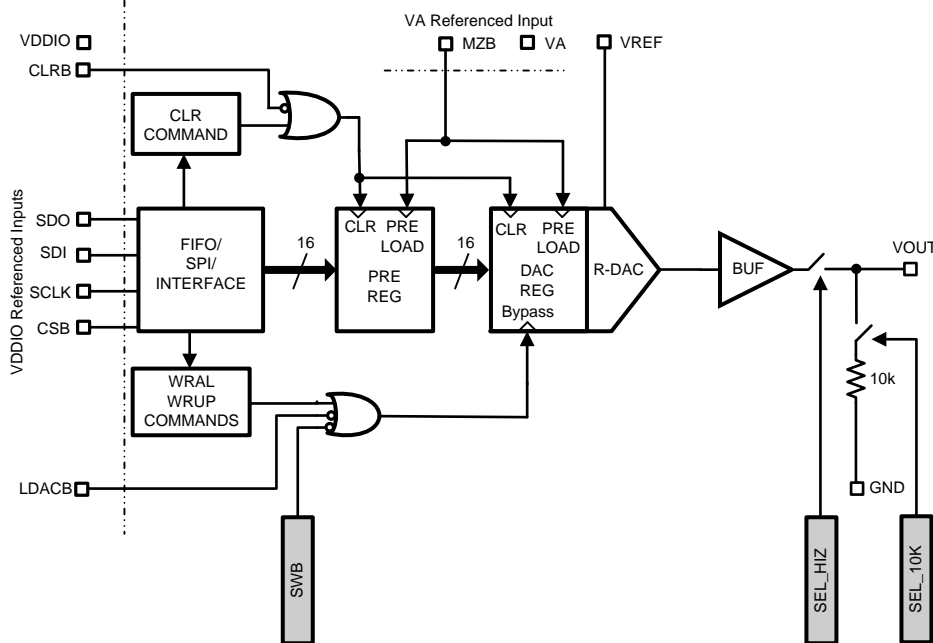

Connection Diagram

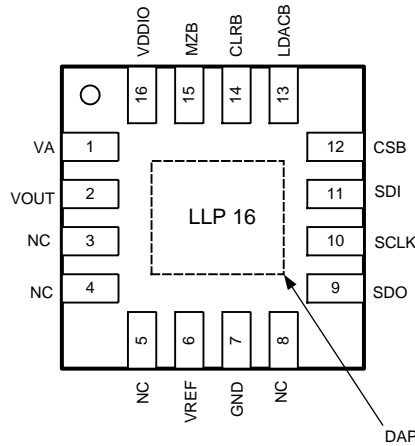

Pin Functions

Pin Descriptions

Pin Name	Pin # LLP-16	ESD Structure	Type	Function and Connection
VDDIO	16		Power	SPI, CLR B, LDACB Supply Voltage.

Pin Descriptions (continued)

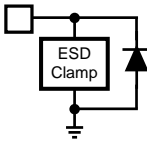
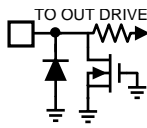
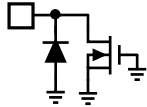
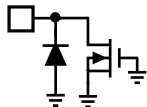
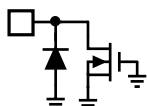
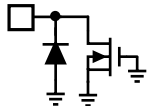
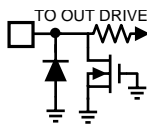
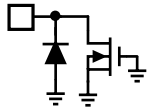
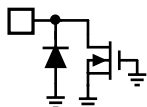
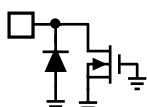
Pin Name	Pin # LLP-16	ESD Structure	Type	Function and Connection
VA	1		Power	Analog Supply Voltage.
VOUT	2		Analog Output	DAC output.
VREF	6		Analog Input	Voltage Reference Input.
GND	7		Ground	Ground (Analog and Digital).
SDI	11		Digital Input	SPI data input .
CSB	12		Digital Input	Chip select signal for SPI interface. On the falling edge of CSB the chip begins to accept data and output data with the SCLK signal. This pin is active low.
SCLK	10		Digital Input	Serial data clock for SPI Interface.
SDO	9		Digital Output	Data Out for daisy chain or data read back verification.
LDACB	13		Digital Input	Load DAC signal. This signal transfers DAC data from the SPI input register to the DAC output register. The signal is active low.
CLRB	14		Digital Input	Asynchronous Reset. If this pin is pulled low, the output will be updated to its power up condition set by the MZB pin. This pin is active low.
MZB	15		Digital Input	Power up at Zero/Mid-scale. Tie this pin to GND to power up to Zero or to VA to power up to mid-scale.

Pin Descriptions (continued)

Pin Name	Pin # LLP-16	ESD Structure	Type	Function and Connection
NC	3,4,5,8			No connect pins. Connect to GND in board layout will result in the lowest amount of coupled noise.
DAP	DAP			Attach die attach paddle to GND for best noise performance.



These devices have limited built-in ESD protection. The leads should be shorted together or the device placed in conductive foam during storage or handling to prevent electrostatic damage to the MOS gates.

Absolute Maximum Ratings ⁽¹⁾ ⁽²⁾

Supply Voltage, V_A	-0.3V to 6.0V
Supply Voltage V_{DDIO}	-0.3V to $V_A+0.3V$
Any pin relative to GND	6V, -0.3V
Voltage on MZB or VREF Input Pin ⁽³⁾	-0.3V to $V_A+0.3V$
Voltage on any other Input Pin ⁽³⁾	-0.3V to $V_{DDIO}+0.3V$
Voltage on V_{OUT} ⁽³⁾	-0.3V to $V_A+0.3V$
Voltage on SDO ⁽³⁾	-0.3V to $V_{DDIO}+0.3V$
Input Current at Any Pin ⁽³⁾	5mA
Output Current Source or Sink by Vout	10mA
Output Current Source or Sink by SDO	3mA
Total Package Input and Output Current	20mA
ESD Susceptibility	
Human Body Model	3000V
Machine Model	250V
Charged Device Model (CDM)	1250V
Storage Temperature Range	-65°C to +150°C
Junction Temperature	+150°C
For soldering specifications: see product folder at www.national.com and www.national.com/ms/MS/MS-SOLDERING.pdf	

- (1) **Absolute Maximum Ratings** indicate limits beyond which damage to the device may occur, including inoperability and degradation of device reliability and/or performance. Functional operation of the device and/or non-degradation at the Absolute Maximum Ratings or other conditions beyond those indicated in the Recommended Operating Conditions is not implied. The recommended Operating Conditions indicate conditions at which the device is functional and the device should not be operated beyond such conditions.
- (2) The Electrical characteristics tables list guaranteed specifications under the listed Recommended Conditions except as otherwise modified or specified by the Electrical Characteristics Conditions and/or Notes. Typical specifications are estimations only and are not guaranteed.
- (3) When the input voltage (V_I) at any pin exceeds the power supplies ($V_I < \text{GND}$ or $V_I > \text{VDD}$) the current at that pin must be limited to 5mA and V_I has to be within the Absolute Maximum Rating for that pin. The 20mA package input current rating limits the number of pins that can safely exceed the power supplies with current flow to four.

Recommended Operating Conditions ⁽¹⁾ ⁽²⁾

Operating Temperature Range	-40°C to +105°C
Supply Voltage, V_A	+2.7V to 5.25V
Supply Voltage VDDIO	+1.7 V to V_A
Reference Voltage VREF	+2.5V to V_A
Digital Input Voltage	0 to VDDIO
Output Load	0 to 200 pF

- (1) **Absolute Maximum Ratings** indicate limits beyond which damage to the device may occur, including inoperability and degradation of device reliability and/or performance. Functional operation of the device and/or non-degradation at the Absolute Maximum Ratings or other conditions beyond those indicated in the Recommended Operating Conditions is not implied. The recommended Operating Conditions indicate conditions at which the device is functional and the device should not be operated beyond such conditions.
- (2) The Electrical characteristics tables list guaranteed specifications under the listed Recommended Conditions except as otherwise modified or specified by the Electrical Characteristics Conditions and/or Notes. Typical specifications are estimations only and are not guaranteed.

Recommended Operating Conditions ⁽¹⁾ ⁽²⁾ (continued)

Package Thermal Resistance θ_{JA} ⁽³⁾ θ_{JC}	41°C/W 6.5°C/W
--	-------------------

(3) The maximum power dissipation is a function of $T_{J(MAX)}$ and θ_{JA} . The maximum allowable power dissipation at any ambient temperature is $P_D = (T_{J(MAX)} - T_A) / \theta_{JA}$

Electrical Characteristics

The following specifications apply for $V_A = 2.7V$ to $5.25V$, $V_{DDIO} = V_A$, $V_{REF} = 2.5V$ to V_A , $R_L = 10k$ to GND, $C_L = 200$ pF to GND, $f_{SCLK} = 20$ MHz, input code range 512 to 65023. **Boldface limits apply for $T_{MIN} \leq T_A \leq T_{MAX}$** : all other limits apply to $T_A = 25^\circ C$, unless otherwise specified.^{(1) (2) (3)}

Symbol	Parameter	Conditions	Min	Typ	Max	Units
STATIC PERFORMANCE						
N	Resolution		16			Bits
INL	Integral Non-Linearity	No load. From code 512 to Full Scale - 512. $V_A=5V$, $V_{REF}=4.096V$		± 1	± 3	LSB
DNL	Differential Non-Linearity	No load. From code 512 to Full Scale - 512. $V_A=5V$, $V_{REF}=4.096V$	-1		1.1	LSB
ZE	Zero Code Error			4	15	mV
FSE	Full Scale Error		-15		15	mV
OE	Offset Error		-11	± 1	11	mV
	Offset Error Drift			± 4		$\mu V/^\circ C$
GE	Gain Error	No load. From code 512 to Full Scale - 512. $V_A=5V$, $V_{REF}=4.096V$		± 0.05		% of FS
	Gain Temperature Coefficient	No load. From code 512 to Full Scale - 512. $V_A=5V$, $V_{REF}=4.096V$	-25		25	mV
				± 2		ppm FS/ $^\circ C$
REFERENCE INPUT CHARACTERISTICS						
V_{REF}	Reference Input Voltage Range	$V_A = 2.7V$ to $5.25V$	2.5		V_A	V
	Reference Input Impedance			12.5		k Ω
ANALOG OUTPUT CHARACTERISTICS						
	Output Voltage Range	No load.	0.015		VA-0.04	V
	DC Output Impedance			2		Ω
ZCO	Zero Code Output	$V_A=3V$, $I_{OUT}=200 \mu A$; $V_{REF}=2.5$ $V_A=3V$, $I_{OUT}=1mA$; $V_{REF}=2.5$ $V_A=5V$, $I_{OUT}=200 \mu A$; $V_{REF}=4.096$ $V_A=5V$, $I_{OUT}=1mA$; $V_{REF}=4.096$		3 4 4 4		mV
FSO	Full Scale Output	$V_A=3V$, $I_{OUT}=200 \mu A$; $V_{REF}=2.5$ $V_A=3V$, $I_{OUT}=1mA$; $V_{REF}=2.5$ $V_A=5V$, $I_{OUT}=200 \mu A$; $V_{REF}=4.096$ $V_A=5V$, $I_{OUT}=1mA$; $V_{REF}=4.096$		2.495 2.494 4.091 4.089		V
C_L	Maximum Capacitive Load	Parallel R = 10K Ω Series R = 50 Ω		500 15		pF μF
R_L	Minimum Resistive Load			10		k Ω
I_{SC}	Short Circuit Current	$V_A = +5V$, $V_{REF}=4.096$		353		mA
t_{PU}	Power-up Time	From Power Down Mode		25		ms
ANALOG OUTPUT DYNAMIC CHARACTERISTICS						
SR	Voltage Output Slew Rate	Positive and negative		2		V/ μs
t_s	Voltage Output Settling Time	$\frac{1}{4}$ scale to $\frac{3}{4}$ scale $V_{REF}= V_A = +5V$, settle to ± 1 LSB.		5		μs
	Digital Feedthrough	Code 0, all digital inputs from GND to VDDIO		1		nV-s

- (1) **Absolute Maximum Ratings** indicate limits beyond which damage to the device may occur, including inoperability and degradation of device reliability and/or performance. Functional operation of the device and/or non-degradation at the Absolute Maximum Ratings or other conditions beyond those indicated in the Recommended Operating Conditions is not implied. The recommended Operating Conditions indicate conditions at which the device is functional and the device should not be operated beyond such conditions.
- (2) The Electrical characteristics tables list guaranteed specifications under the listed Recommended Conditions except as otherwise modified or specified by the Electrical Characteristics Conditions and/or Notes. Typical specifications are estimations only and are not guaranteed.
- (3) Typical values represent most likely parametric norms at specific conditions (Example V_A ; specific temperature) and at the recommended Operating Conditions at the time of product characterizations and are not guaranteed.

Electrical Characteristics (continued)

The following specifications apply for $V_A = 2.7V$ to $5.25V$, $V_{DDIO} = V_A$, $V_{REF} = 2.5V$ to V_A , $R_L = 10k$ to GND, $C_L = 200$ pF to GND, $f_{SCLK} = 20$ MHz, input code range 512 to 65023. **Boldface limits apply for $T_{MIN} \leq T_A \leq T_{MAX}$** : all other limits apply to $T_A = 25^\circ C$, unless otherwise specified.^{(1) (2) (3)}

Symbol	Parameter	Conditions	Min	Typ	Max	Units
	Major Code Transition Analog Glitch Impulse	$V_A=5V$, $V_{REF}=2.5V$. Transition from mid-scale - 1LSB to mid-scale.		7		nV-s
	Output Noise	Spot noise at 20 kHz		120		nV/ \sqrt{Hz}
	Integrated Output Noise	1Hz to 10 kHz		18		μV
DIGITAL INPUT CHARACTERISTICS						
I_{IN}	Input Current				± 1	μA
V_{IL}	Input Low Voltage	$V_{DDIO}=5V$			0.8	V
		$V_{DDIO}=3V$			0.8	
		$V_{DDIO}=1.8V$			0.4	
V_{IH}	Input High Voltage	$V_{DDIO}=5V$	2.1			V
		$V_{DDIO}=3V$	2.1			
		$V_{DDIO}=1.8V$	1.4			
V_{ILMZB}	MZB Input Low Voltage	$V_A=5V$			0.8	V
		$V_A=3V$			0.8	V
V_{IHMZB}	MZB Input High Voltage	$V_A=5V$	2.1			V
		$V_A=3V$	2.1			V
C_{IN}	Input Capacitance			4		pF
DIGITAL OUTPUT CHARACTERISTICS						
V_{OL}	Output Low Voltage	$I_{sink}=200 \mu A$; $V_{DDIO}>3V$			400	mV
		$I_{sink}=2mA$; $V_{DDIO}>3V$			400	
		$I_{sink}=200 \mu A$; $V_{DDIO}=1.8V$			400	
		$I_{sink}=2mA$; $V_{DDIO}=1.8V$			400	
V_{OH}	Output High Voltage	$I_{sink}=200 \mu A$; $V_{DDIO}>3V$	VDDIO - 0.2			V
		$I_{sink}=2mA$; $V_{DDIO}>3V$	VDDIO - 0.2			
		$I_{sink}=200 \mu A$; $V_{DDIO}=1.8V$	VDDIO - 0.2			
		$I_{sink}=2mA$; $V_{DDIO}=1.8V$	1.15			
I_{OZH} , I_{OZL}	TRI-STATE Leakage Current			<1n	$\pm 1\mu$	A
C_{OUT}	TRI-STATE Output Capacitance			4		pF
POWER REQUIREMENTS						
V_A	Analog Supply Voltage Range		2.7		5.25	V
V_{DDIO}	Digital Supply Voltage Range		1.7		VA	V
I_{VA}	VA Supply Current	No load. SCLK Idle. All digital inputs at GND or VDDIO. $V_A=5V$		0.75	1	mA
		No load. SCLK Idle. All digital inputs at GND or VDDIO. $V_A=3.3V$		0.62	1	mA
I_{REF}	Reference Current				350	μA
I_{PDVA}	VA Power Down Supply Current	All digital inputs at GND or VDDIO		0.5	3	
I_{PDVO}	VDDIO Power Down Supply Current	All digital inputs at GND or VDDIO			1	
I_{PDVR}	VREF Power Down Supply Current				1	

Electrical Characteristics Digital Interface Timing Characteristics

These specifications apply for $V_A = 2.7V$ to $5.25V$, $V_{DDIO} = 1.7V$ to V_A , $CL = 200$ pF. **Boldface limits apply for $T_A = -40^\circ C$ to $105^\circ C$.** All other limits apply to $T_A = 25^\circ C$, unless otherwise specified.

Symbol	Parameter	Conditions	Min	Typ	Max	Units
f_{SCLK}	SCLK Frequency	VDDIO=1.7V to 2.7V	0		10	MHz
		VDDIO=2.7V to 5.25V	0		20	
t_H	SCLK High Time		15	25		ns
t_L	SCLK Low Time		20	25		
t_{CSB}	CSB High Pulse width	VDDIO=1.7V to 2.7V		75		
		VDDIO=2.7V to 5.25V		40		
t_{CSS}	CSB Set-up Time Prior to SCLK Rising edge		10			
t_{CSH}	CSB Hold Time after the 24th Falling Edge of SCLK			0		
t_{zSDO}	CSB Falling Edge to SDO Valid	VDDIO=1.8V		40		
		VDDIO=3V		10		
		VDDIO=5V		6		
t_{SDOZ}	CSB Rising Edge to SDO HiZ	VDDIO=1.8V		75		
		VDDIO=3V		40		
		VDDIO=5V		27		
t_{CLRS}	CSB Rising Edge to CLR \overline{B} Falling Edge	CLR \overline{B} must not transition anytime CSB is low.		5		
t_{LDACS}	CSB Rising Edge to LDAC \overline{B} Falling Edge	LDAC \overline{B} must not transition anytime CSB is low.		5		
t_{LDAC}	LDAC \overline{B} Low Time		10	2.5		
t_{CLR}	CLR \overline{B} Low Time		10	2.5		
t_{DS}	SDI Data Set-up Time prior to SCLK Rising Edge			10		
t_{DH}	SDI Data Hold Time after SCLK Rising Edge			0		
t_{DO}	SDO Output Data Valid	VDDIO=1.7			62	
		VDDIO=3.3			25	
		VDDIO=5			15	

Timing Diagrams

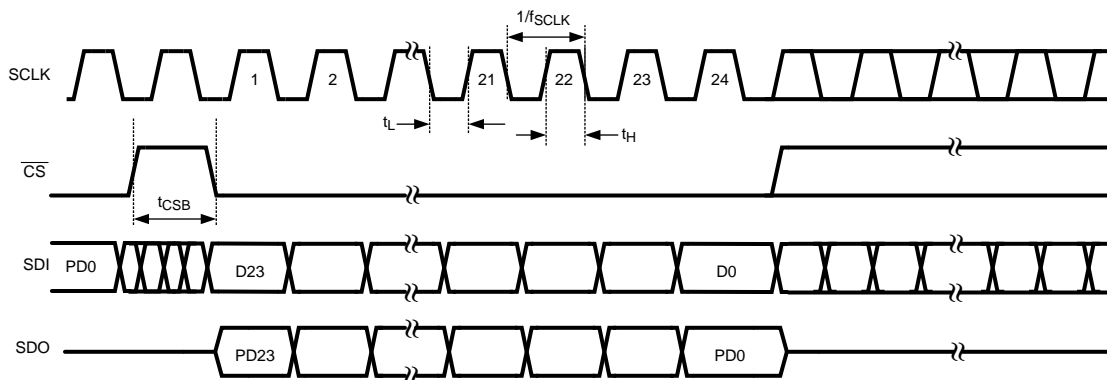

Figure 1. DAC161S055 Input/Output Waveforms

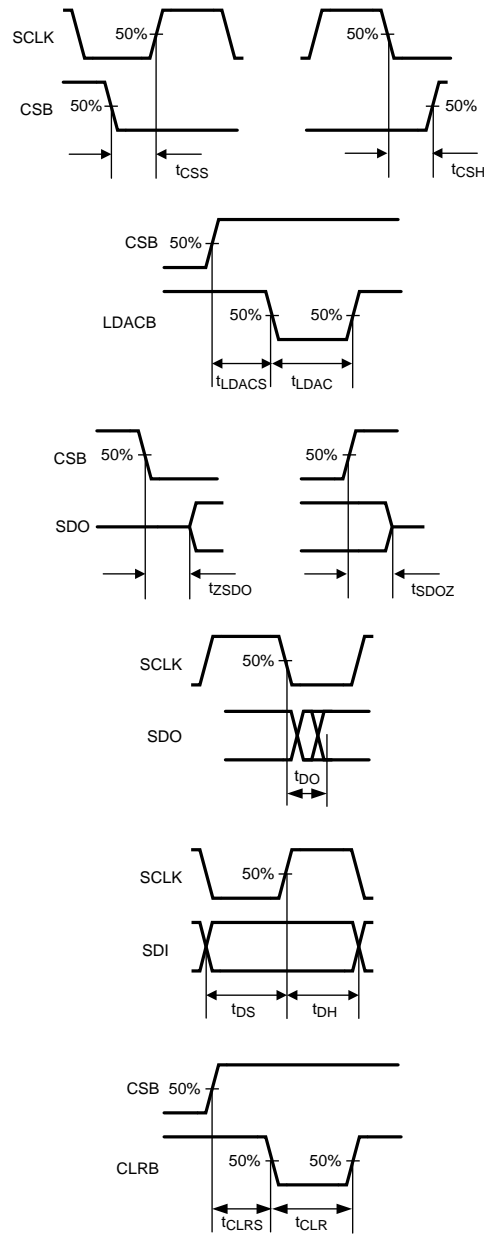

Figure 2. Timing Parameter Specifics

Transfer Characteristics

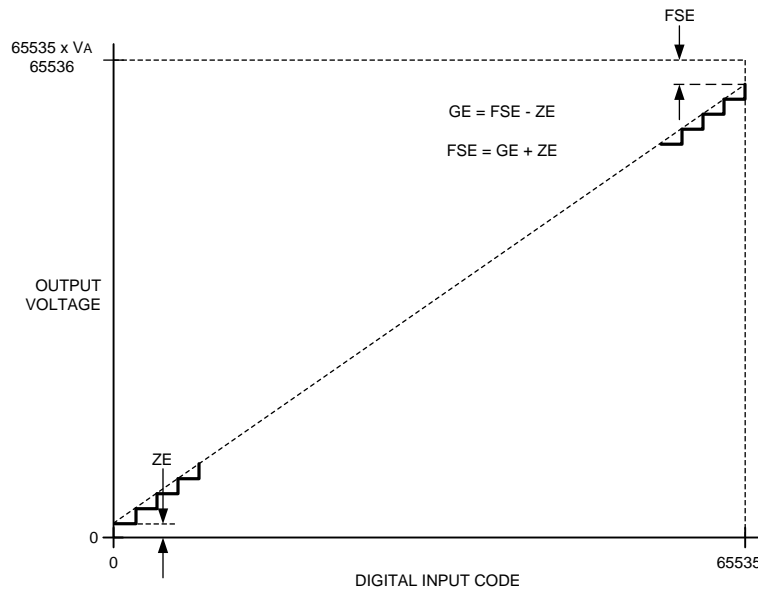

Figure 3. Input/Output Transfer Characteristic

Specification Definitions

DIFFERENTIAL NON-LINEARITY (DNL) is the measure of the maximum deviation from the ideal step size of 1 LSB, which is $V_{REF} / 65536$.

DIGITAL FEEDTHROUGH is a measure of the energy injected into the analog output of the DAC from the digital inputs when the DAC outputs are not updated. It is measured with a full-scale code change on the data bus.

FULL-SCALE ERROR is the difference between the actual output voltage with a full scale code (FFFh) loaded into the DAC and the value of $V_{REF} \times 65535 / 65536$.

GAIN ERROR is the deviation from the ideal slope of the transfer function. It can be calculated from Zero and Full-Scale Errors as $GE = FSE - ZE$, where GE is Gain error, FSE is Full-Scale Error and ZE is Zero Error.

GLITCH IMPULSE is the energy injected into the analog output when the input code to the DAC register changes. It is specified as the area of the glitch in nanovolt-seconds.

INTEGRAL NON-LINEARITY (INL) is a measure of the deviation of each individual code from a straight line through the input to output transfer function. The deviation of any given code from this straight line is measured from the center of that code value. The end point method is used. INL for this product is specified over a limited range, per the Electrical Tables.

LEAST SIGNIFICANT BIT (MSB) is the bit that has the smallest value or weight of all bits in a word. This value is $LSB = V_{REF} / 2^n$ where V_{REF} is the reference voltage for this product, and "n" is the DAC resolution in bits, which is 16 for the DAC161S055.

MAXIMUM LOAD CAPACITANCE is the maximum capacitance that can be driven by the DAC with output stability maintained, although some ringing may be present.

MONOTONICITY is the condition of being monotonic, where the DAC output never decreases when the input code increases.

MOST SIGNIFICANT BIT (MSB) is the bit that has the largest value or weight of all bits in a word. Its value is $1/2$ of V_{REF} .

OFFSET ERROR is the difference between zero voltage and a where a straight line fit to the actual transfer function intersects the y axis.

SETTLING TIME is the time for the output to settle to within 1 LSB of the final value after the input code is updated.

WAKE-UP TIME is the time for the output to recover after the device is commanded to the active mode from any of the power down modes.

ZERO CODE ERROR is the output error, or voltage, present at the DAC output after a code of 0000h has been entered.

Typical Performance Characteristics

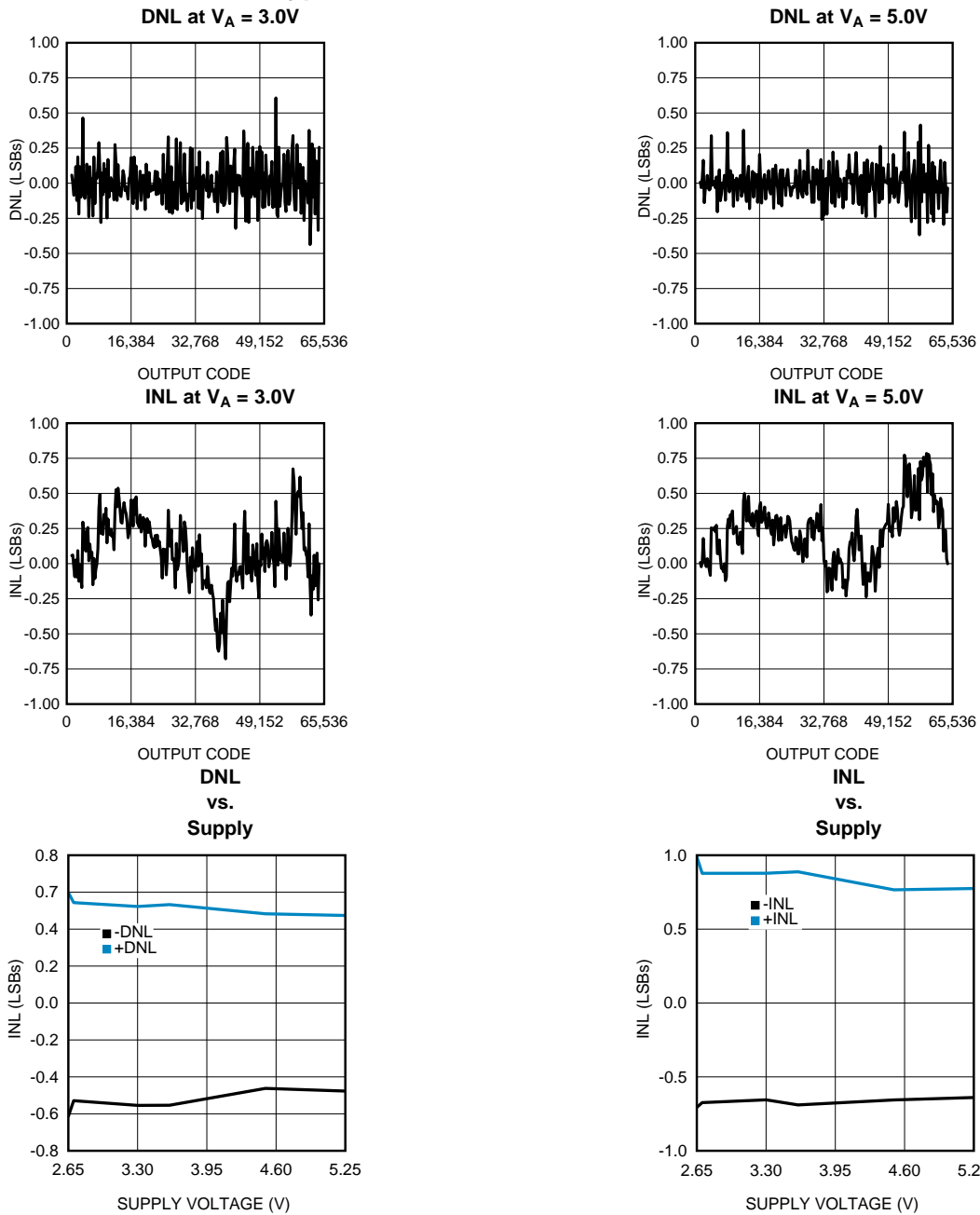

Typical Performance Characteristics (continued)

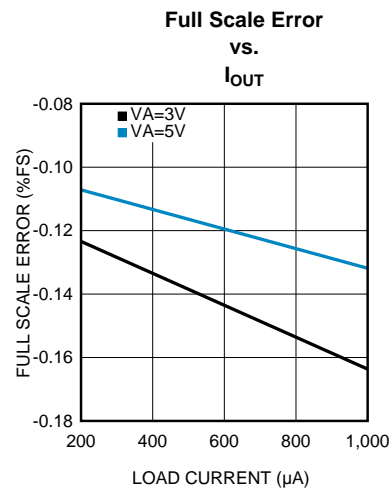
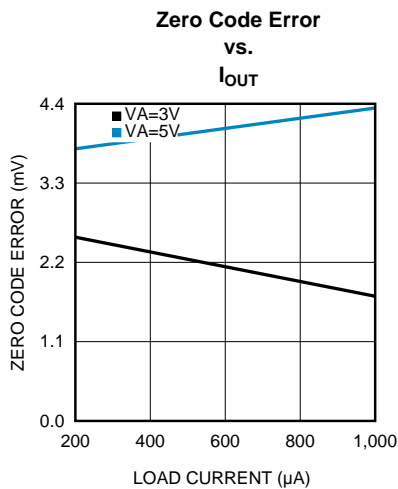
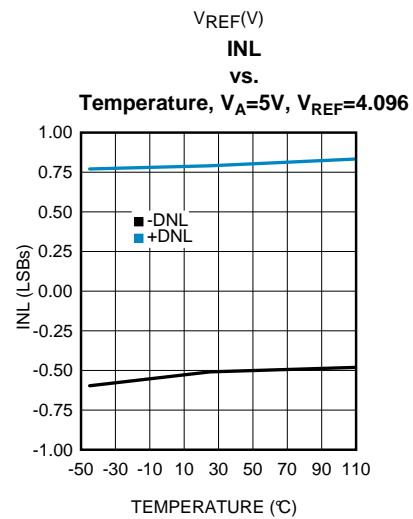
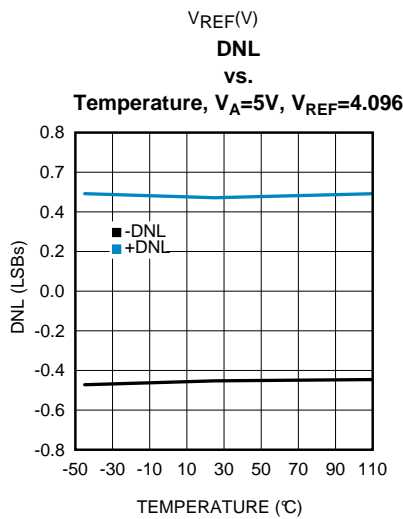
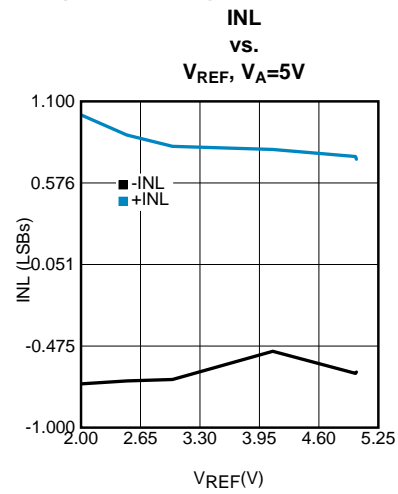
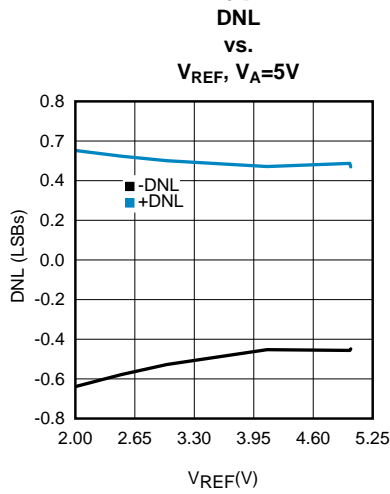

Typical Performance Characteristics (continued)

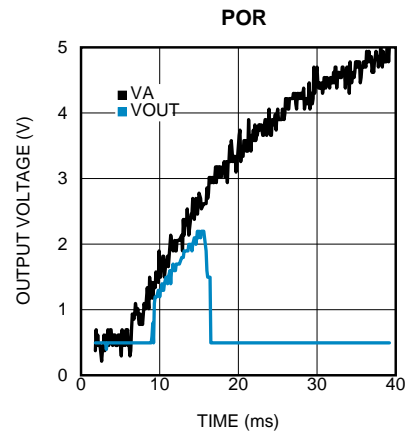
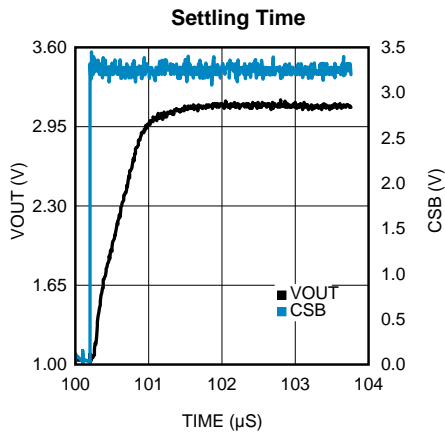
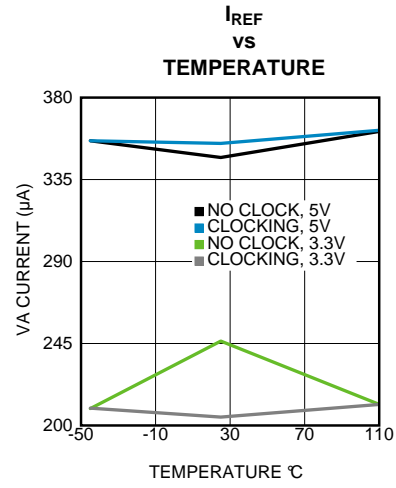
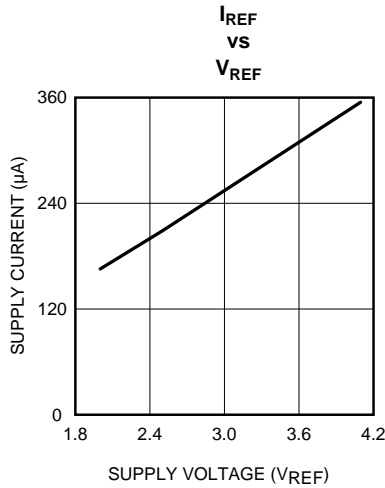
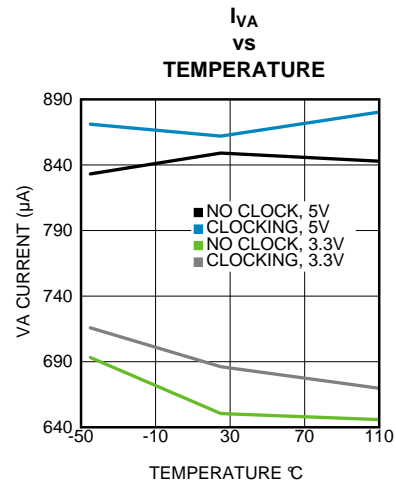
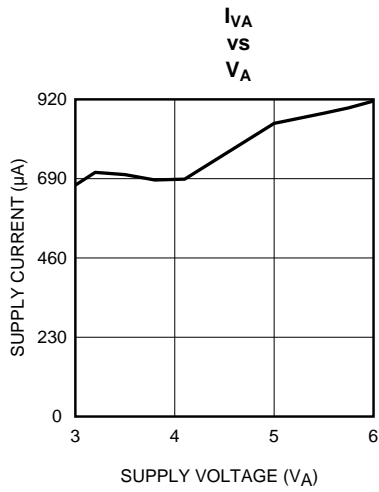

Typical Performance Characteristics (continued)

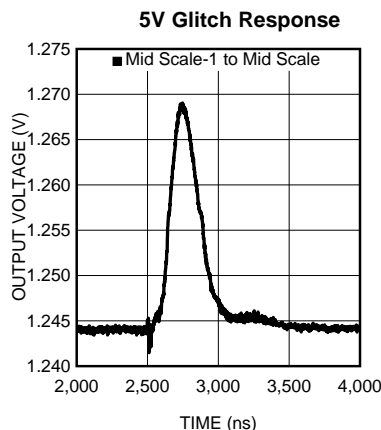

1.0 Functional Description

1.1 DAC ARCHITECTURE OVERVIEW

The DAC161S055 uses a resistor array to convert the input code to an analog signal, which in turn is buffered by the rail-to-rail output amplifier. The resistor array is factory trimmed to achieve 16-bit accuracy.

An SPI interface shifts the input codes into the device. The acquired input code is stored in the PREREG register. After the input code is transferred to the DACREG register it affects the state of the resistor array and the output level of the DAC. The transfer can be initiated by the type of write command used, by a software LDAC command or by the state of the LDACB pin.

The user can control the power up state of the output using the MZB pin and the power down state of the output using the CONFIG register. Additionally, there are external pins and CONFIG register bits that also control clearing the DAC.

NOTE: Although the DAC161S055 is a single channel device, the instruction set is for multichannel DACs. The user must address channel 0 (A2,A1,A0={000}).

1.2 OUTPUT AMPLIFIER

The output buffer amplifier is a rail to rail type which buffers the signal produced by the resistor array and drives the external load. All amplifiers, including rail to rail amplifiers, exhibit a loss of linearity as the output nears the power rails (in this case GND and V_A). Thus the linearity of the part is specified over less than the full output range. The user can program the CONFIG register to power down the amplifier and either place it in the high impedance state (HiZ), or have the output terminated by an internal 10 k Ω pull-down resistor.

1.3 REFERENCE

An external reference source is required to produce an output. The reference input is not internally buffered and presents a resistive load to the external source. Loading presented by the VREF pin varies by about 12.5% depending on the input code. Thus a low impedance reference should be used for best results.

1.4 SERIAL INTERFACE

The 4-wire interface is compatible with SPI, QSPI and MICROWIRE, as well as most DSPs. See the [Timing Diagrams](#) for timing information about the read and write sequences. The serial interface is the four signals CSB, SCLK, SDI and SDO.

A bus transaction is initiated by the falling edge of the CSB. Once CSB is low, the input data is sampled at the SDI pin by the rising edge of the SCLK. The output data is put out on the SDO pin on the falling edge of SCLK. At least 24 SCLK cycles are required for a valid transfer to occur. If CSB is raised before 24th rising edge of the SCLK, the transfer is aborted. If the CSB is held low after the 24th falling edge of the SCLK, the data will continue to flow through the FIFO and out the SDO pin. Once CSB transitions high, the internal controller will decode the most recent 24 bits that were received before the rising edge of CSB. The DAC will then change state depending on the instruction sent and the state of the LDACB pin.

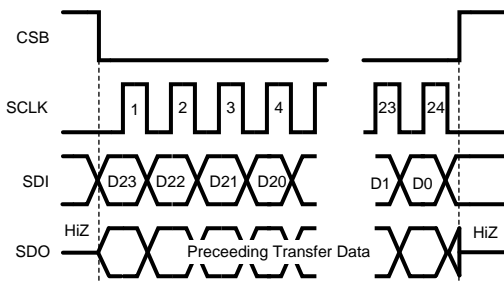

The acquired data is shifted into an internal 24 bit shift register (MSB first) which is configured as a 24 bit deep FIFO. As the data is being shifted into the FIFO via the SDI pin, the prior contents of the register are being shifted out through the SDO output. While CSB is high, SDO is in a high-Z state. At the falling edge of CSB, SDO presents the MSB of the data present in the shift register. SDO is updated on every subsequent falling edge of SCLK (note — the first SDO transition will happen on the first falling edge AFTER the first rising edge of SCLK when CSB is low).

The 24 bits of data contained in the FIFO are interpreted as an 8 bit COMMAND word followed by 16 bits of DATA. The general format of the 24 bit data stream is shown below. The full Instruction Set is tabulated in Section 1.12 INSTRUCTION SET.

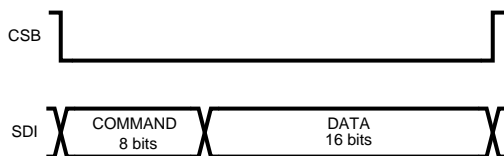

1.4.1 SPI Write

SPI write operation is the simplest transaction available to the user. There is no handshaking between master and the slave (DAC161S055), and the master is the source of all signals required for communication: SCLK, CSB, SDI. The format of the data transfer is described in the section 1.4. The user instruction set is shown in Section 1.12 INSTRUCTION SET.

1.4.2 SPI Read

The read operation requires all 4 wires of the SPI interface: SCLK, SCB, SDI, SDO. The simplest READ operation occurs automatically during any valid transaction on the SPI bus since SDO pin of DAC161S055 always shifts out the contents of the internal FIFO. Therefore the user can verify the data being shifted in to the FIFO by initiating another transaction and acquiring data at SDO. This allows for verification of the FIFO contents only.

The 3 internal registers (PREREG, DACREG, CONFIG) can be accessed by the user through the Register Read commands: RDDO, RDIN, RDCO respectively (see Section 1.12 INSTRUCTION SET). These operations require 2 SPI transaction to recover the register data. The first transaction shifts in the Register Read command; an 8 bit command byte followed by 16 bit “dummy” data. The Register Read command will cause the transfer of contents of the internal register into the FIFO. The second transaction will shift out the FIFO contents; an 8 bit command byte (which is a copy of previous transaction) followed by the register data. The Register Read operation is shown in the figure below.

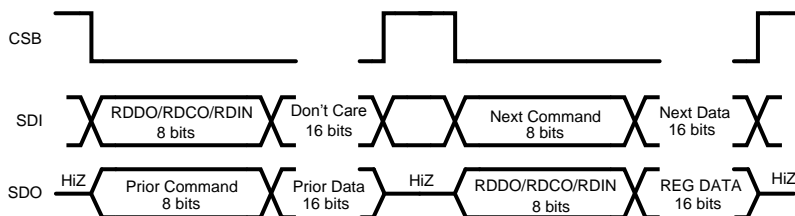

1.4.2 SPI Daisy Chain

It is possible to control multiple DACs or other SPI devices with a single master equipped with one SPI interface. This is accomplished by connecting the DACs in a Daisy Chain. The scheme is depicted in the figure below. An arbitrary length of the chain and an arbitrary number of control bits for other devices in the chain is possible since individual DAC devices do not count the data bits shifted in. Instead, they wait to decode the contents of their respective shift registers until CSB is raised high.

A typical bus cycle for this scheme is initiated by the falling CSB. After the 24 SCLK cycles new data starts to appear at the SDO pin of the first device in the chain, and starts shifting into the second device. After 72 SCLK cycles following the falling CSB edge, all three devices in this example will contain new data in their input shift registers. Raising CSB will begin the process of decoding data in each DAC. When in the Daisy Chain the full READ and WRITE capability of every device is maintained.

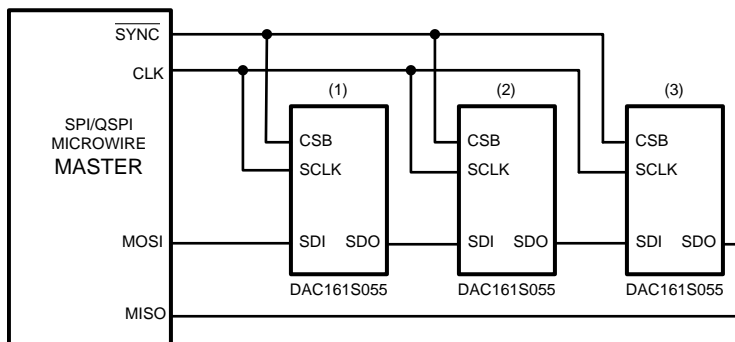

A sample of SPI data transfer appropriate for a 3 DAC Daisy Chain is shown in the figure below.

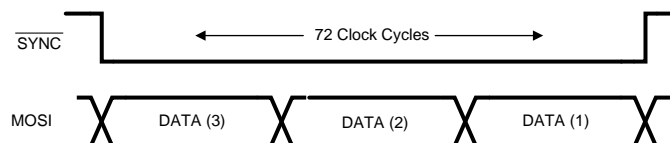

1.5 POWER-UP DEFAULT OUTPUT

It is possible to power up the DAC with the output either at GND or midscale. This functionality is achieved by connecting the MZB pin either to GND or to VA (note, the MZB pin is referenced to VA, not VDDIO). Usually this function is hardwired in the application, but can also be controlled by a GPIO pin of the μ C. To power up with output at zero, tie the MZB pin low. To power up with output at midscale, tie MZB high. The MZB pin is level sensitive.

1.6 CHANGING DAC OUTPUT

There are multiple different ways to affect the DAC output. The CONFIG register can be changed so that a write to the PREREG is seen instantly at the output. The LDAC function or LDACB pin updates the output instantly. Finally, the type of write command (WRUP, WRAL, WR) can affect if the output updates instantly or not.

1.6.1 Write-Through and Write-Block Modes

Using the SWB bit of the CONFIG register, the user can set the part in **WRITE-BLOCK** or **WRITE-THROUGH** mode.

If the DAC channel is configured in the **WRITE-BLOCK** mode (SWB=0, default), the DAC input DATA is held in the PREREG until the controller forces the transfer of DATA from PREREG to DACREG register. Only DATA in DACREG register is converted to the equivalent analog output. The transfer from PREREG into DACREG can be forced by both software and hardware LDAC commands. The Data Writing commands WRUP and WRAL update both PREREG and DACREG at the same time regardless of the channel mode. **WRITE-BLOCK** mode is used in multi device or multi channel applications. A user can preload all DAC channels with desired data, in multiple SPI transactions, and then issue a single software LDAC command (or toggle the LDACB pin) to simultaneously update all analog outputs.

If the DAC channel is configured in **WRITE-THROUGH** mode (SWB=1) the controller updates both PREREG and DACREG registers simultaneously. Therefore in WRITE-THROUGH mode the channel output is updated as soon as the SPI transfer is completed i.e. upon the rising edge of CSB.

1.6.2 LDAC Function

The LDACB (Load DAC) pin provides a easy way to synchronize several DACs and update the output without any SPI latency. If the LDACB is asserted low, the content of the PREREG register is instantaneously moved into the DACREG register. The LDACB pin is level sensitive. If the LDACB pin is held low continuously, the DAC output will update as soon as the CSB pin goes high.

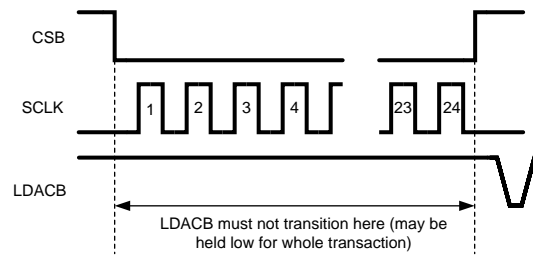

The DAC Configuration command LDAC (see Section [1.12 INSTRUCTION SET](#) below) will also update the DAC output as soon as it is received. The effect of hardware LDACB or software LDAC is the same i.e. data is transferred from the PREREG to DACREG and output of the DAC is updated.

1.6.3 Write Commands

There are three write commands available in the DAC command set. Issuing a WR command causes the DAC to update either the PREREG or the DACREG depending on the setting of the SWB bit (see Section [1.6.1 Write-Through and Write-Block Modes](#)). Issuing a WRUP command causes the specified channels output (for multiple channel parts) to update immediately, regardless of the SWB bit setting. Issuing a WRAL command causes all channels (for multiple channel parts) to update immediately with the same data, regardless of the SWB bit setting.

1.8 CLEAR FUNCTION

The CLR pin provides a easy way to reset the DAC161S055 output. If the CLR pin goes low, VOUT instantaneously slews to the value indicated by the MZB pin, either zero or midscale. The CLR pin is level sensitive.

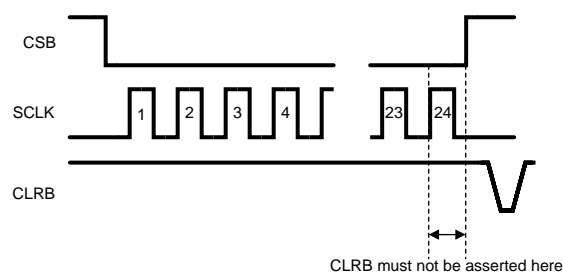

Clear function can also be accessed via the software instruction CLR, see Section [1.12 INSTRUCTION SET](#) below. The effect of hardware CLR or software CLR is the same.

1.9 POWER ON RESET

An on-chip power on reset circuit (POR) ensures that the DAC always powers on in the same state. The registers will be loaded with the defaults shown in Section [1.12 INSTRUCTION SET](#). The output state will be controlled by the state of the MZB pin.

1.10 POWER DOWN

Power down is achieved by writing the PD instruction and setting the appropriate bit to a logic '1'. In the PD command, it is possible to specify if the output is left in a high impedance (HIZ) state or if it is pulled to GND through a 10K resistor. During power down, the output amplifier is disabled and the resistor ladder is disconnected from Vref. The SPI interface remains active. To exit power down, write the PD command again, setting the appropriate bit to a logic '0'. Note that the SPI interface and the registers are all active during power down.

1.11 INTERNAL REGISTERS

There are 3 registers that are accessible to the user. The data registers (PREREG and DACREG) are both readable and writable from the command set. The CONFIG register is only readable from the command set. Bits in the CONFIG register are set by the commands detailed in Section [1.12 INSTRUCTION SET](#).

PREREG: DAC Preload Data Register(16Bits)									
	R/W	R/W	R/W	R/W	R/W	R/W	R/W	R/W	
MSB	PRD15	PRD14	PRD13	PRD12	PRD11	PRD10	PRD9	PRD8	
	Bit15	Bit14	Bit13	Bit12	Bit11	Bit10	Bit9	Bit8	
	R/w	R/W	R/W	R/W	R/W	R/W	R/W	R/W	
LSB	PRD7	PRD6	PRD5	PRD4	PRD3	PRD2	PRD1	PRD0	
	Bit7	Bit6	Bit5	Bit4	Bit3	Bit2	Bit1	Bit0	
Bit15–0:	16 bit data word to be converted. Bit 15 has a weight of $1/2 \cdot V_{ref}$. Bit 0 has a weight of $V_{ref}/2^{16}$.								

DACREG: DAC Output Data Register(16Bits)									
	R/W	R/W	R/W	R/W	R/W	R/W	R/W	R/W	
MSB	IND15	IND14	IND13	IND12	IND11	IND10	IND9	IND8	
	Bit15	Bit14	Bit13	Bit12	Bit11	Bit10	Bit9	Bit8	
	R/w	R/W	R/W	R/W	R/W	R/W	R/W	R/W	
LSB	IND7	IND6	IND5	IND4	IND3	IND2	IND1	IND0	
	Bit7	Bit6	Bit5	Bit4	Bit3	Bit2	Bit1	Bit0	
Bit15–0:	16 bit data word to be converter. Bit 15 has a weight of $1/2 \cdot V_{ref}$. Bit 0 has a weight of $V_{ref}/2^{16}$.								

CONFIG: DAC Configuration Reporting Register (8 Bits)									
	R	R	R	R	R	R	R	R	
MSB	—	—	—	—	—	SWB	SEL_10K	SEL_HIZ	
	Bit7	Bit6	Bit5	Bit4	Bit3	Bit2	Bit1	Bit0	
Bit7–3:	Reserved. Read value is undefined and should be discarded.								
Bit2:	SWB: Set Write Block bit								
	0: Channel is in WRITE THROUGH mode.								
	1: Channel is in WRITE BLOCK mode.								
Bit1:	0: Channel is either active or SEL_HIZ is set.								
	1: Channel is powered down and output is terminated by a 10K resistor to GND.								
Bit0:	0: Channel is either active or SEL_10K is set.								
	1: Channel is powered down and output is in high impedance state.								

1.12 INSTRUCTION SET

The instruction set for the DAC161S055 is common to the family of single and multi channel devices (DAC16xS055). The DAC161S055 has only a single channel — Channel 0.

NOTE: DATA WRITING and REGISTER READING instructions encode the channel address as a binary triplet (A2,A1,A0) as the last three LSBs of the command byte. DAC CONFIGURATION instructions encode the channel selection by a bit set in the data bytes. For example, when executing the LDAC instruction a payload of {0100 0001} in the least significant byte of the instruction indicates channels 6 and 0 are targeted.

MNEMONIC	Command Byte[7:0]									DATA[15:8]	DATA [7:0]	Description	DEFAULT
DAC Configuration													
NOP	0	0	0	0	0	0	0	0	0	xxxx xxxx	xxxx xxxx	No Operation	
CLR	0	0	0	0	0	0	0	0	1	xxxx xxxx	xxxx xxxx	Clear internal registers, return to Power-Up default state	
LDAC	0	0	0	1	1	0	0	0	0	xxxx xxxx	CHANNEL[7:0]	Software LOAD DAC. A '1' causes data stored in the specified channel's PREREG to be transferred to DACREG and the output updated.	
SWB	0	0	1	0	1	0	0	0	0	xxxx xxxx	CHANNEL[7:0]	Set WRITE BLOCK or WRITE THROUGH for the selected channels.	00FFh
												0: WRITE THROUGH 1: WRITE BLOCK	
PD	0	0	1	1	0	0	0	0	0	CHANNEL[7:0]	CHANNEL[7:0]	Sets SEL_10K or SEL_HIZ. Upper 8 bits PD Hi-Z; Lower 8-bits PD 10K; if both are 1's; PD -> 10K	0000h
												1: Upper 8 bits: SEL_HIZ	
												1: Lower 8 bits: SEL_10K	
												1: Both upper and lower: SEL_10K	
Data Writing													
WR	0	0	0	0	1	A2	A1	A0		DACDATA[15:8]	DACDATA[7:0]	Write to specified channel. WRITE BLOCK or WRITE THROUGH setting controls destination register (PREREG or DACREG).	
WRUP	0	0	0	1	0	A2	A1	A0		DACDATA[15:8]	DACDATA[7:0]	Update specified channel's DACREG and PREREG regardless of WRITE BLOCK or WRITE THROUGH setting.	
WRAL	0	0	1	0	0	0	0	0	0	DACDATA[15:8]	DACDATA[7:0]	Update all channel's DACREG and PREREG regardless of WRITE BLOCK or WRITE THROUGH setting.	
Register Reading													
<Reserved >	1	0	0	0	0	x	x	x				<Reserved>	
RDDO	1	0	0	0	1	A2	A1	A0		DACDATA[15:8]	DACDATA[7:0]	Read PREREG register.	
RDCO	1	0	0	1	0	A2	A1	A0		0000 0000	0000 0,swb,sel_10k,sel_hiz	Read CONFIG register.	0004h
RDIN	1	0	0	1	1	A2	A1	A0		DACDATA[15:8]	DACDATA[7:0]	Read DACREG register.	

2.0 Applications Information

2.1 SAMPLE INSTRUCTION SEQUENCE

The following table shows an example instruction sequence to illustrate the usage of different modes of operation of the DAC. This sequence is for a one channel DAC.

Step	Instruction	8-bit Command	16 bit Payload	Comments
1	CLR	0000 0001	0000 0000 0000 0000	Clear device - return to Power-Up Default State
2	WR	0000 1000	0100 0000 0000 0000	Write ¼ FS into channel 0. Since device by default is in WRITE-BLOCK mode the data will be written into PREREG, and DAC output will not update
3	LDAC	0001 1000	xxxx xxxx 0000 0001	Issue LDAC command to channel 0. Data is transferred from PREREG into DACREG and DAC output updates to ¼ FS
4	SWB	0010 1000	xxxx xxxx 1111 1110	Set channels 1 to 7 to WRITE-BLOCK mode, and channel 0 to WRITE-THROUGH mode
5	WR	0000 1000	1111 1111 1111 1111	DAC output updates immediately to FS since the channel is set to write through mode.
6	PD	0011 0000	0000 0001 0000 0000	Power down the device, and set the channel 0 DAC output to the HIZ state

2.2 USING REFERENCES AS POWER SUPPLIES

Although the DAC has a separate reference and analog power pin, it is still possible to use a reference to drive both. This arrangement will avoid a separate voltage regulator for V_A and will provide a more stable voltage source. The LM4140 has an initial accuracy of 0.1%, is capable of driving 8mA and comes in a 4.096V version. Bypassing both the input and the output will improve noise performance.

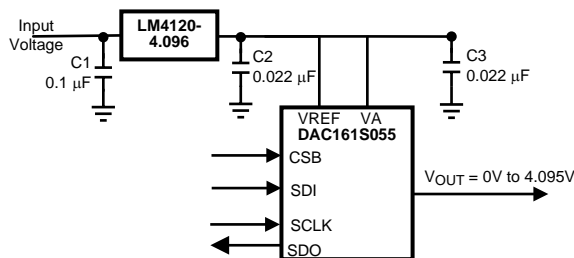

Figure 4. Using the LM4120 as a power supply

2.3 A LOW NOISE EXAMPLE

A LM4050 powered off of a battery is a good choice for very low noise prototype circuits. The minimum value for R must be chosen so that the LM4050 does not draw more than its 15mA rating. Note the largest current through the LM4050 will occur when the DAC is shutdown. The maximum resistor value must allow the LM4050 to draw more than its minimum current for regulation plus the maximum V_{REF} current.

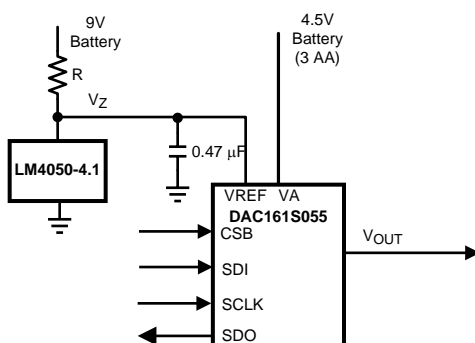

Figure 5. Using the LM4050 in a low noise circuit



2.4 LAYOUT, GROUNDING AND BYPASSING

For best accuracy and minimum noise, the printed circuit board containing the DAC should have separate analog and digital areas. These areas are defined by the locations of the analog and digital power planes. Both power planes should be in the same board layer. There should be a single ground plane. Frequently a single ground plane design will utilize a fencing technique to prevent the mixing of analog and digital ground currents. Separate ground planes should only be used if the fencing technique proves inadequate. The separate ground planes must be connected in a single place, preferably near the DAC. Special care is required to guarantee that digital signals with fast edge rates do not pass over split ground planes. The fast digital signals must always have a continuous return path below their traces.

When possible, the DAC power supply should be bypassed with a 10 μ F and a 0.1 μ F capacitor placed as close as possible to the device with the 0.1 μ F closest to the supply pin. The 10 μ F capacitor should be a tantalum type and the 0.1 μ F capacitor should be a low ESL, low ESR type. Sometime, the loading requirements of the regulator driving the DAC do not allow such capacitance to be placed on the regulator output. In those cases, bypass should be as large as allowed by the regulator using a low ESL, low ESR capacitance. In the LM4120 example above, the supply is bypassed with 0.022 μ F ceramic capacitors. The DAC should be fed with power that is only used for analog circuits.

Avoid crossing analog and digital signals and keep the clock and data lines on the component side of the board. The clock and data lines should have controlled impedances.

PACKAGING INFORMATION

Orderable Device	Status (1)	Package Type	Package Drawing	Pins	Package Qty	Eco Plan (2)	Lead/Ball Finish	MSL Peak Temp (3)	Op Temp (°C)	Top-Side Markings (4)	Samples
DAC161S055CISQ/NOPB	ACTIVE	WQFN	RGH	16	1000	Green (RoHS & no Sb/Br)	CU SN	Level-3-260C-168 HR	-40 to 105	161S055	
DAC161S055CISQE/NOPB	ACTIVE	WQFN	RGH	16	250	Green (RoHS & no Sb/Br)	CU SN	Level-3-260C-168 HR	-40 to 105	161S055	
DAC161S055CISQX/NOPB	ACTIVE	WQFN	RGH	16	4500	Green (RoHS & no Sb/Br)	CU SN	Level-3-260C-168 HR	-40 to 105	161S055	

(1) The marketing status values are defined as follows:

ACTIVE: Product device recommended for new designs.

LIFEBUY: TI has announced that the device will be discontinued, and a lifetime-buy period is in effect.

NRND: Not recommended for new designs. Device is in production to support existing customers, but TI does not recommend using this part in a new design.

PREVIEW: Device has been announced but is not in production. Samples may or may not be available.

OBSOLETE: TI has discontinued the production of the device.

(2) Eco Plan - The planned eco-friendly classification: Pb-Free (RoHS), Pb-Free (RoHS Exempt), or Green (RoHS & no Sb/Br) - please check <http://www.ti.com/productcontent> for the latest availability information and additional product content details.

TBD: The Pb-Free/Green conversion plan has not been defined.

Pb-Free (RoHS): TI's terms "Lead-Free" or "Pb-Free" mean semiconductor products that are compatible with the current RoHS requirements for all 6 substances, including the requirement that lead not exceed 0.1% by weight in homogeneous materials. Where designed to be soldered at high temperatures, TI Pb-Free products are suitable for use in specified lead-free processes.

Pb-Free (RoHS Exempt): This component has a RoHS exemption for either 1) lead-based flip-chip solder bumps used between the die and package, or 2) lead-based die adhesive used between the die and leadframe. The component is otherwise considered Pb-Free (RoHS compatible) as defined above.

Green (RoHS & no Sb/Br): TI defines "Green" to mean Pb-Free (RoHS compatible), and free of Bromine (Br) and Antimony (Sb) based flame retardants (Br or Sb do not exceed 0.1% by weight in homogeneous material)

(3) MSL, Peak Temp. -- The Moisture Sensitivity Level rating according to the JEDEC industry standard classifications, and peak solder temperature.

(4) Only one of markings shown within the brackets will appear on the physical device.

Important Information and Disclaimer: The information provided on this page represents TI's knowledge and belief as of the date that it is provided. TI bases its knowledge and belief on information provided by third parties, and makes no representation or warranty as to the accuracy of such information. Efforts are underway to better integrate information from third parties. TI has taken and continues to take reasonable steps to provide representative and accurate information but may not have conducted destructive testing or chemical analysis on incoming materials and chemicals. TI and TI suppliers consider certain information to be proprietary, and thus CAS numbers and other limited information may not be available for release.

In no event shall TI's liability arising out of such information exceed the total purchase price of the TI part(s) at issue in this document sold by TI to Customer on an annual basis.

TAPE AND REEL INFORMATION

QUADRANT ASSIGNMENTS FOR PIN 1 ORIENTATION IN TAPE

*All dimensions are nominal

Device	Package Type	Package Drawing	Pins	SPQ	Reel Diameter (mm)	Reel Width W1 (mm)	A0 (mm)	B0 (mm)	K0 (mm)	P1 (mm)	W (mm)	Pin1 Quadrant
DAC161S055CISQ/NOPB	WQFN	RGH	16	1000	178.0	12.4	4.3	4.3	1.3	8.0	12.0	Q1
DAC161S055CISQE/NOPB	WQFN	RGH	16	250	178.0	12.4	4.3	4.3	1.3	8.0	12.0	Q1
DAC161S055CISQX/NOPB	WQFN	RGH	16	4500	330.0	12.4	4.3	4.3	1.3	8.0	12.0	Q1

TAPE AND REEL BOX DIMENSIONS

*All dimensions are nominal

Device	Package Type	Package Drawing	Pins	SPQ	Length (mm)	Width (mm)	Height (mm)
DAC161S055CISQ/NOPB	WQFN	RGH	16	1000	203.0	190.0	41.0
DAC161S055CISQE/NOP B	WQFN	RGH	16	250	203.0	190.0	41.0
DAC161S055CISQX/NOP B	WQFN	RGH	16	4500	358.0	343.0	63.0

RGH0016A

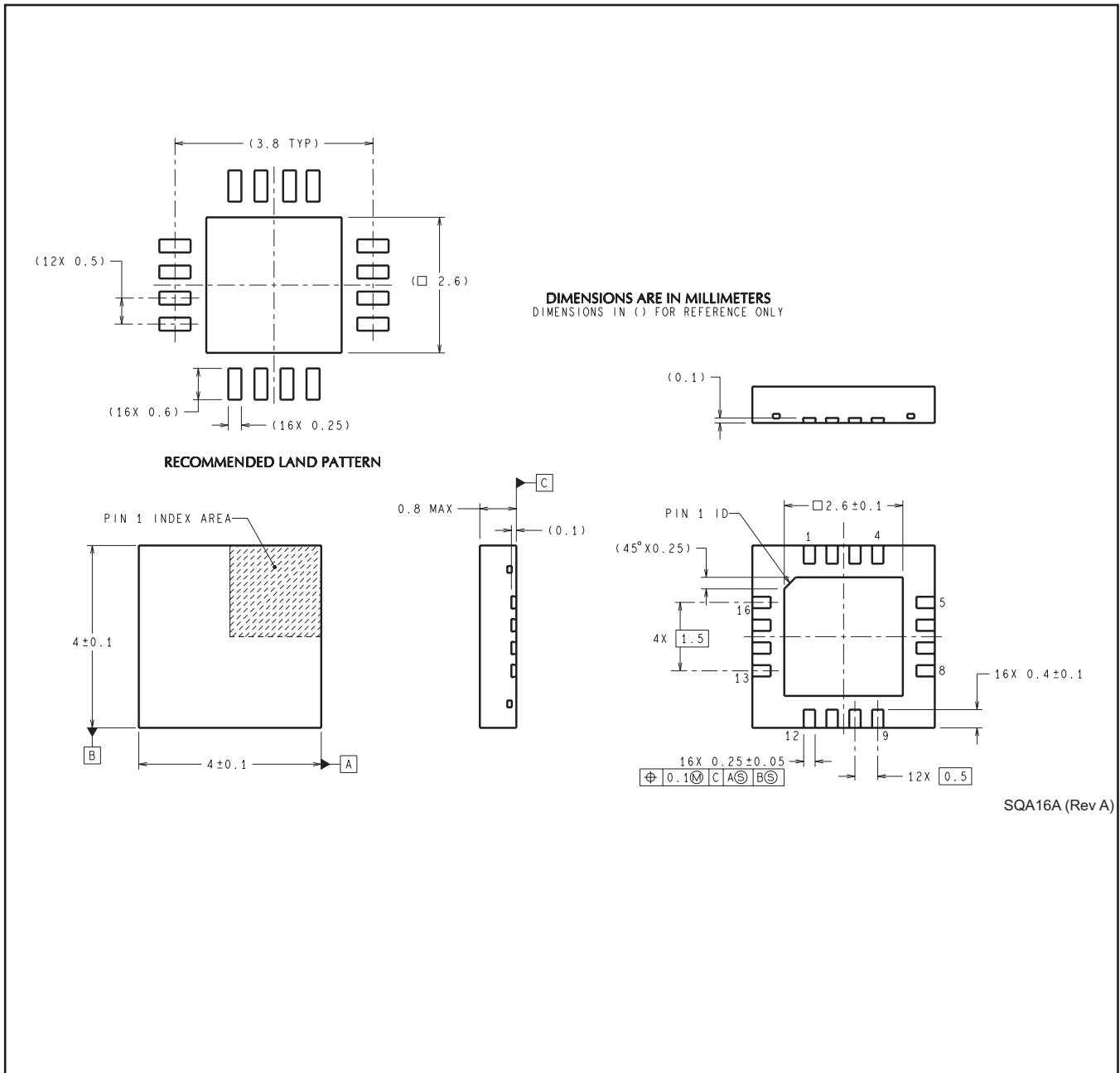

IMPORTANT NOTICE

Texas Instruments Incorporated and its subsidiaries (TI) reserve the right to make corrections, enhancements, improvements and other changes to its semiconductor products and services per JESD46, latest issue, and to discontinue any product or service per JESD48, latest issue. Buyers should obtain the latest relevant information before placing orders and should verify that such information is current and complete. All semiconductor products (also referred to herein as "components") are sold subject to TI's terms and conditions of sale supplied at the time of order acknowledgment.

TI warrants performance of its components to the specifications applicable at the time of sale, in accordance with the warranty in TI's terms and conditions of sale of semiconductor products. Testing and other quality control techniques are used to the extent TI deems necessary to support this warranty. Except where mandated by applicable law, testing of all parameters of each component is not necessarily performed.

TI assumes no liability for applications assistance or the design of Buyers' products. Buyers are responsible for their products and applications using TI components. To minimize the risks associated with Buyers' products and applications, Buyers should provide adequate design and operating safeguards.

TI does not warrant or represent that any license, either express or implied, is granted under any patent right, copyright, mask work right, or other intellectual property right relating to any combination, machine, or process in which TI components or services are used. Information published by TI regarding third-party products or services does not constitute a license to use such products or services or a warranty or endorsement thereof. Use of such information may require a license from a third party under the patents or other intellectual property of the third party, or a license from TI under the patents or other intellectual property of TI.

Reproduction of significant portions of TI information in TI data books or data sheets is permissible only if reproduction is without alteration and is accompanied by all associated warranties, conditions, limitations, and notices. TI is not responsible or liable for such altered documentation. Information of third parties may be subject to additional restrictions.

Resale of TI components or services with statements different from or beyond the parameters stated by TI for that component or service voids all express and any implied warranties for the associated TI component or service and is an unfair and deceptive business practice. TI is not responsible or liable for any such statements.

Buyer acknowledges and agrees that it is solely responsible for compliance with all legal, regulatory and safety-related requirements concerning its products, and any use of TI components in its applications, notwithstanding any applications-related information or support that may be provided by TI. Buyer represents and agrees that it has all the necessary expertise to create and implement safeguards which anticipate dangerous consequences of failures, monitor failures and their consequences, lessen the likelihood of failures that might cause harm and take appropriate remedial actions. Buyer will fully indemnify TI and its representatives against any damages arising out of the use of any TI components in safety-critical applications.

In some cases, TI components may be promoted specifically to facilitate safety-related applications. With such components, TI's goal is to help enable customers to design and create their own end-product solutions that meet applicable functional safety standards and requirements. Nonetheless, such components are subject to these terms.

No TI components are authorized for use in FDA Class III (or similar life-critical medical equipment) unless authorized officers of the parties have executed a special agreement specifically governing such use.

Only those TI components which TI has specifically designated as military grade or "enhanced plastic" are designed and intended for use in military/aerospace applications or environments. Buyer acknowledges and agrees that any military or aerospace use of TI components which have **not** been so designated is solely at the Buyer's risk, and that Buyer is solely responsible for compliance with all legal and regulatory requirements in connection with such use.

TI has specifically designated certain components as meeting ISO/TS16949 requirements, mainly for automotive use. In any case of use of non-designated products, TI will not be responsible for any failure to meet ISO/TS16949.

Products

Audio	www.ti.com/audio
Amplifiers	amplifier.ti.com
Data Converters	dataconverter.ti.com
DLP® Products	www.dlp.com
DSP	dsp.ti.com
Clocks and Timers	www.ti.com/clocks
Interface	interface.ti.com
Logic	logic.ti.com
Power Mgmt	power.ti.com
Microcontrollers	microcontroller.ti.com
RFID	www.ti-rfid.com
OMAP Applications Processors	www.ti.com/omap
Wireless Connectivity	www.ti.com/wirelessconnectivity

Applications

Automotive and Transportation	www.ti.com/automotive
Communications and Telecom	www.ti.com/communications
Computers and Peripherals	www.ti.com/computers
Consumer Electronics	www.ti.com/consumer-apps
Energy and Lighting	www.ti.com/energy
Industrial	www.ti.com/industrial
Medical	www.ti.com/medical
Security	www.ti.com/security
Space, Avionics and Defense	www.ti.com/space-avionics-defense
Video and Imaging	www.ti.com/video

TI E2E Community

e2e.ti.com

Mouser Electronics

Authorized Distributor

Click to View Pricing, Inventory, Delivery & Lifecycle Information:

[Texas Instruments:](#)

[DAC161S055CISQ/NOPB](#) [DAC161S055CISQE/NOPB](#) [DAC161S055CISQX/NOPB](#)