



**MCP42XX
PICtail™ Plus
Daughter Board
User's Guide**

Note the following details of the code protection feature on Microchip devices:

- Microchip products meet the specification contained in their particular Microchip Data Sheet.
- Microchip believes that its family of products is one of the most secure families of its kind on the market today, when used in the intended manner and under normal conditions.
- There are dishonest and possibly illegal methods used to breach the code protection feature. All of these methods, to our knowledge, require using the Microchip products in a manner outside the operating specifications contained in Microchip's Data Sheets. Most likely, the person doing so is engaged in theft of intellectual property.
- Microchip is willing to work with the customer who is concerned about the integrity of their code.
- Neither Microchip nor any other semiconductor manufacturer can guarantee the security of their code. Code protection does not mean that we are guaranteeing the product as "unbreakable."

Code protection is constantly evolving. We at Microchip are committed to continuously improving the code protection features of our products. Attempts to break Microchip's code protection feature may be a violation of the Digital Millennium Copyright Act. If such acts allow unauthorized access to your software or other copyrighted work, you may have a right to sue for relief under that Act.

Information contained in this publication regarding device applications and the like is provided only for your convenience and may be superseded by updates. It is your responsibility to ensure that your application meets with your specifications. MICROCHIP MAKES NO REPRESENTATIONS OR WARRANTIES OF ANY KIND WHETHER EXPRESS OR IMPLIED, WRITTEN OR ORAL, STATUTORY OR OTHERWISE, RELATED TO THE INFORMATION, INCLUDING BUT NOT LIMITED TO ITS CONDITION, QUALITY, PERFORMANCE, MERCHANTABILITY OR FITNESS FOR PURPOSE. Microchip disclaims all liability arising from this information and its use. Use of Microchip devices in life support and/or safety applications is entirely at the buyer's risk, and the buyer agrees to defend, indemnify and hold harmless Microchip from any and all damages, claims, suits, or expenses resulting from such use. No licenses are conveyed, implicitly or otherwise, under any Microchip intellectual property rights.

Trademarks

The Microchip name and logo, the Microchip logo, Accuron, dsPIC, KEELOQ, KEELOQ logo, MPLAB, PIC, PICmicro, PICSTART, rPIC and SmartShunt are registered trademarks of Microchip Technology Incorporated in the U.S.A. and other countries.

FilterLab, Linear Active Thermistor, MXDEV, MXLAB, SEEVAL, SmartSensor and The Embedded Control Solutions Company are registered trademarks of Microchip Technology Incorporated in the U.S.A.

Analog-for-the-Digital Age, Application Maestro, CodeGuard, dsPICDEM, dsPICDEM.net, dsPICworks, dsSPEAK, ECAN, ECONOMONITOR, FanSense, In-Circuit Serial Programming, ICSP, ICEPIC, Mindi, MiWi, MPASM, MPLAB Certified logo, MPLIB, MPLINK, mTouch, PICkit, PICDEM, PICDEM.net, PICTail, PIC³² logo, PowerCal, PowerInfo, PowerMate, PowerTool, REAL ICE, rLAB, Select Mode, Total Endurance, UNI/O, WiperLock and ZENA are trademarks of Microchip Technology Incorporated in the U.S.A. and other countries.

SQTP is a service mark of Microchip Technology Incorporated in the U.S.A.

All other trademarks mentioned herein are property of their respective companies.

© 2008, Microchip Technology Incorporated, Printed in the U.S.A., All Rights Reserved.

 Printed on recycled paper.

**QUALITY MANAGEMENT SYSTEM
CERTIFIED BY DNV
== ISO/TS 16949:2002 ==**

Microchip received ISO/TS-16949:2002 certification for its worldwide headquarters, design and wafer fabrication facilities in Chandler and Tempe, Arizona; Gresham, Oregon and design centers in California and India. The Company's quality system processes and procedures are for its PIC[®] MCUs and dsPIC[®] DSCs, KEELOQ[®] code hopping devices, Serial EEPROMs, microperipherals, nonvolatile memory and analog products. In addition, Microchip's quality system for the design and manufacture of development systems is ISO 9001:2000 certified.



MCP42XX PICTAIL™ PLUS DAUGHTER BOARD USER'S GUIDE

Table of Contents

Preface	1
Introduction.....	1
Document Layout	1
Conventions Used in this Guide	2
Recommended Reading.....	3
The Microchip Web Site	3
Customer Support	3
Document Revision History	3
Chapter 1. Product Overview	
1.1 Introduction	5
1.2 What is the MCP42XX PICtail Plus Daughter Board?	6
1.3 What the MCP42XX PICtail Plus Daughter Board Kit includes	7
Chapter 2. Installation and Operation	
2.1 Introduction	9
2.2 Features	9
2.3 Getting Started	10
2.4 Explorer 16 Daughter Demo Board Demos	14
Appendix A. Schematic and Layouts	
A.1 Introduction	29
A.2 Schematics and PCB Layout	29
A.3 Board - Schematic	30
A.4 Board – Top Silk-screen Layer	31
A.5 Board – Top Components + Silk-Screen	32
A.6 Board – Ground Layer	33
A.7 Board – Power Layer	34
A.8 Board – Bottom Layer	35
Appendix B. Bill Of Materials (BOM)	
Appendix C. Board Testing	
C.1 Introduction	39
C.2 What is Tested	40
C.3 What is NOT Tested	40
Worldwide Sales and Service	42

MCP42XX PICtail™ Plus Daughter Board User's Guide

NOTES:



MCP42XX PICTAIL™ PLUS DAUGHTER BOARD USER'S GUIDE

Preface

NOTICE TO CUSTOMERS

All documentation becomes dated, and this manual is no exception. Microchip tools and documentation are constantly evolving to meet customer needs, so some actual dialogs and/or tool descriptions may differ from those in this document. Please refer to our web site (www.microchip.com) to obtain the latest documentation available.

Documents are identified with a "DS" number. This number is located on the bottom of each page, in front of the page number. The numbering convention for the DS number is "DSXXXXA", where "XXXX" is the document number and "A" is the revision level of the document.

For the most up-to-date information on development tools, see the MPLAB® IDE on-line help. Select the Help menu, and then Topics to open a list of available on-line help files.

INTRODUCTION

This chapter contains general information that will be useful to know before using the MCP42XX PICtail Plus Daughter Board User's Guide. Items discussed in this chapter include:

- Document Layout
- Conventions Used in this Guide
- Recommended Reading
- The Microchip Web Site
- Customer Support
- Document Revision History

DOCUMENT LAYOUT

This document describes how to use the MCP42XX PICtail Plus Daughter Board User's Guide as a development tool to emulate and debug firmware on a target board. The manual layout is as follows:

- **Chapter 1. "Product Overview"** – Important information about the MCP42XX PICtail Plus Daughter Board User's Guide.
- **Chapter 2. "Installation and Operation"** – Includes instructions on how to get started with this user's guide and a description of the user's guide.
- **Appendix A. "Schematic and Layouts"** – Shows the schematic and layout diagrams for the MCP42XX PICtail Plus Daughter Board User's Guide.
- **Appendix B. "Bill Of Materials (BOM)"** – Lists the parts used to build the MCP42XX PICtail Plus Daughter Board User's Guide.
- **Appendix C. "Board Testing"** – Describes the testing method for the MCP42XX PICtail Plus Daughter Board User's Guide and what aspects of the board are and are not tested.

MCP42XX PICtail™ Plus Daughter Board User's Guide

CONVENTIONS USED IN THIS GUIDE

This manual uses the following documentation conventions:

DOCUMENTATION CONVENTIONS

Description	Represents	Examples
Arial font:		
Italic characters	Referenced books	<i>MPLAB® IDE User's Guide</i>
	Emphasized text	...is the <i>only</i> compiler...
Initial caps	A window	the Output window
	A dialog	the Settings dialog
	A menu selection	select Enable Programmer
Quotes	A field name in a window or dialog	"Save project before build"
Underlined, italic text with right angle bracket	A menu path	<u><i>File>Save</i></u>
Bold characters	A dialog button	Click OK
	A tab	Click the Power tab
N'Rnnnn	A number in verilog format, where N is the total number of digits, R is the radix and n is a digit.	4'b0010, 2'hF1
Text in angle brackets < >	A key on the keyboard	Press <Enter>, <F1>
Courier New font:		
Plain Courier New	Sample source code	#define START
	Filenames	autoexec.bat
	File paths	c:\mcc18\h
	Keywords	_asm, _endasm, static
	Command-line options	-Opa+, -Opa-
	Bit values	0, 1
	Constants	0xFF, 'A'
Italic Courier New	A variable argument	<i>file.o</i> , where <i>file</i> can be any valid filename
Square brackets []	Optional arguments	mcc18 [options] <i>file</i> [options]
Curly brackets and pipe character: { }	Choice of mutually exclusive arguments; an OR selection	errorlevel {0 1}
Ellipses...	Replaces repeated text	var_name [, var_name...]
	Represents code supplied by user	void main (void) { ... }

RECOMMENDED READING

This user's guide describes how to use MCP42XX PICtail Plus Daughter Board User's Guide. Other useful documents are listed below. The following Microchip documents are available and recommended as supplemental reference resources.

AN1080 Application Note, “Understanding Digital Potentiometer Resistor Variations”, DS01080

These data sheets provides detailed information regarding the MCP41XX/42XX product family:

MCP413x/415x/423x/425x Data Sheet, “7/8-Bit Single/Dual SPI Digital POT with Non-Volatile Memory”, DS22059

MCP414x/416x/424x/426x Data Sheet, “7/8-Bit Single/Dual SPI Digital POT with Volatile Memory”, DS22060

THE MICROCHIP WEB SITE

Microchip provides online support via our web site at www.microchip.com. This web site is used as a means to make files and information easily available to customers. Accessible by using your favorite Internet browser, the web site contains the following information:

- **Product Support** – Data sheets and errata, application notes and sample programs, design resources, user's guides and hardware support documents, latest software releases and archived software
- **General Technical Support** – Frequently Asked Questions (FAQs), technical support requests, online discussion groups, Microchip consultant program member listing
- **Business of Microchip** – Product selector and ordering guides, latest Microchip press releases, listing of seminars and events, listings of Microchip sales offices, distributors and factory representatives

CUSTOMER SUPPORT

Users of Microchip products can receive assistance through several channels:

- Distributor or Representative
- Local Sales Office
- Field Application Engineer (FAE)
- Technical Support

Customers should contact their distributor, representative or field application engineer (FAE) for support. Local sales offices are also available to help customers. A listing of sales offices and locations is included in the back of this document.

Technical support is available through the web site at: <http://support.microchip.com>

DOCUMENT REVISION HISTORY

Revision A (September 2008)

- Initial Release of this Document.

MCP42XX PICtail™ Plus Daughter Board User's Guide

NOTES:



MCP42XX PICTAIL™ PLUS DAUGHTER BOARD USER'S GUIDE

Chapter 1. Product Overview

1.1 INTRODUCTION

The MCP42XX PICtail Plus Daughter Board demonstrates the features and abilities of Microchip's MCP41XX and MCP42XX Digital Potentiometers. This board is designed to exclusively use the MCP42XX devices.

The MCP41XX and MCP42XX are Digital Potentiometers with an SPI interface. These devices have either 7-bits or 8-bits of resolution, single or dual offering, and are available as either volatile or non-volatile memory options.

This board is designed to easily operate with any of the following:

- PIC24 Explorer 16 Demo Board (DM240001)
- PICkit™ Serial Analyzer (DV164122)
- Other PICDEM Demo Board that includes a PICtail Plus female connector

The use of the PIC24 Explorer 16 Demo Board (DM240001) will require a tool to program the supplied firmware into the PIC24FJ128GA010 device. The use of any other PICDEM Demo Board will require the user to modify the supplied "C" source program appropriately.

The use of the PICkit Serial Analyzer will require the PC GUI interface program to control the command and data sent to the MCP42XX devices serial port. The PICkit Serial Analyzer GUI may be used, or the provided dedicated GUI may be used. The source code for this dedicated GUI is available, but not supported (as is).

This chapter covers the following topics:

- What is the MCP42XX PICtail Plus Daughter Board?
- What the MCP42XX PICtail Plus Daughter Board Kit includes

MCP42XX PICtail™ Plus Daughter Board User's Guide

1.2 WHAT IS THE MCP42XX PICTAIL PLUS DAUGHTER BOARD?

The MCP42XX PICtail Plus Daughter Board is used to demonstrate the use of Digital Potentiometers. This board is designed to be used in conjunction with either the PIC24 Explorer 16 Demo Board or the PICkit™ Serial Analyzer. Figure 1-1 shows the boards component placement and the purpose of the jumpers.

The board has an MCP4261-103 (10 kΩ) device for evaluation. This device is in the TSSOP package (U2). This is a dual 8-bit Non-Volatile Potentiometer device. The MCP4261 uses an SPI interface and can be controlled via the PICkit Serial Analyzer interface (J1) or via the PICtail Plus interface (J3).

When using the PICtail Plus interface, the \overline{CS} voltages can be taken to a V_{IHH} level for high voltage commands. This is done by controlling the selection of the analog switch device (U1).

Jumpers allow the Terminal A and Terminal B voltages to be tied to AVDD and VSS, or come from an external source.

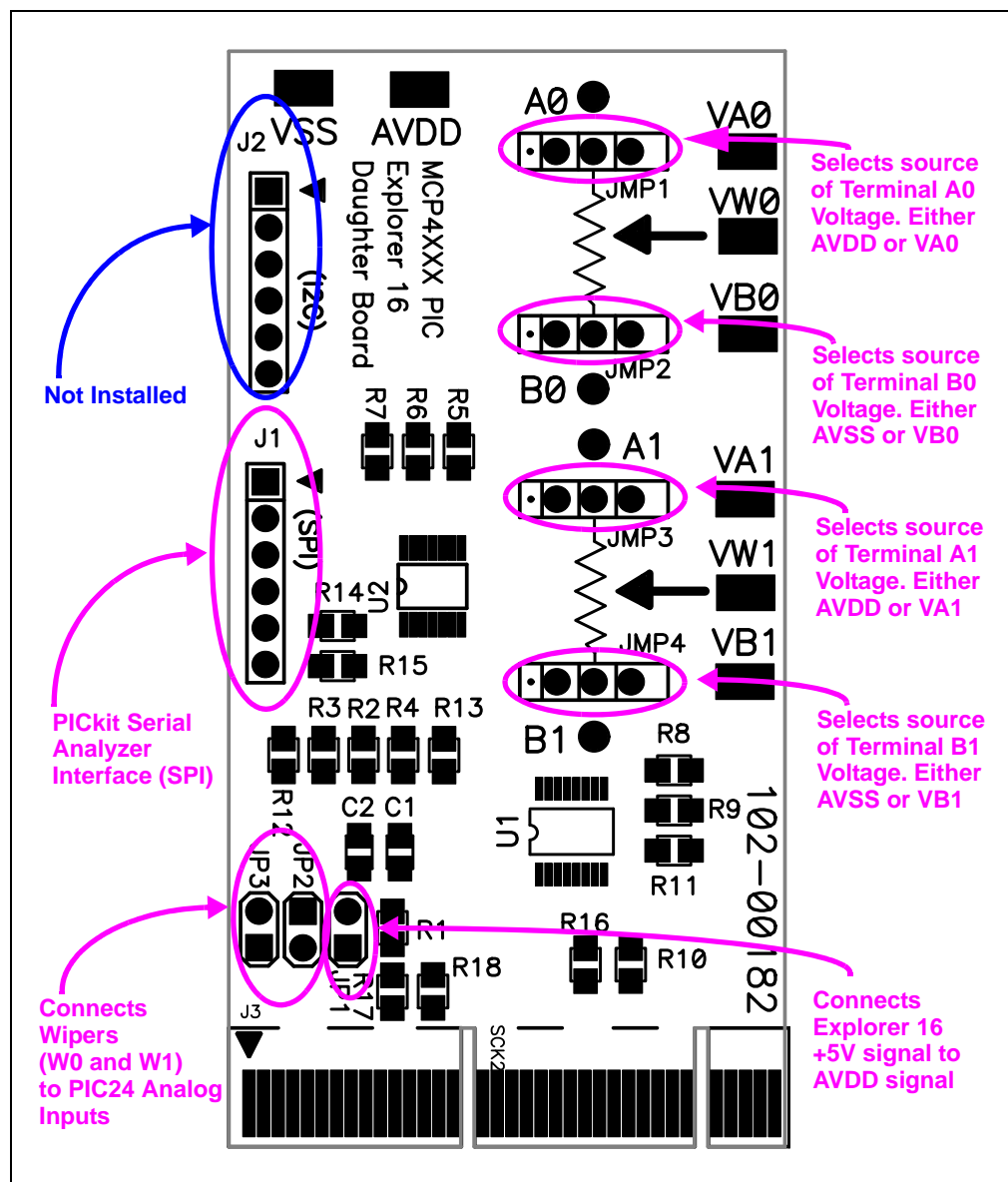

FIGURE 1-1: MCP42XX Explorer 16 Daughter Board Demo Board Connectors.

Some of the features of the board include:

- PICkit Serial Analyzer Interface (J1)
- PICtail Plus Interface (J3)
- MAX4582L High Voltage analog switch to allow \overline{CS} voltage to be selected as one of four voltages (V_{SS} , 3.3V, 5.0V, or 9.0V) - High Voltage command support
- Jumpers (JP2:JP3) to connect Wiper pins (W0 and W1) to PICDEM Analog Channels
- Jumper (JP1) to allow AVDD to be driven by external power supply while connected to PICDEM board or PICkit Serial Analyzer
- Jumpers to allow Terminal A pins to be connected to AV_{DD} or V_{Ax} pad
- Jumpers to allow Terminal B pins to be connected to V_{SS} or V_{Bx} pad
- Connection point for easy connection to Resistor Network Terminal pins

1.3 WHAT THE MCP42XX PICTAIL PLUS DAUGHTER BOARD KIT INCLUDES

This MCP42XX PICtail Plus Daughter Board Kit includes:

- One MCP42XX PICtail Plus Daughter Board, 102-00182
- Analog and Interface Products Demonstration Boards CD-ROM (DS21912)
 - MCP42XX PICtail™ Plus Daughter Board User's Guide, (DS51759)
 - PICkit Serial Analyzer PC GUI (executable and source code) - supplied "As Is"

MCP42XX PICtail™ Plus Daughter Board User's Guide

NOTES:



MCP42XX PICTAIL™ PLUS DAUGHTER BOARD USER'S GUIDE

Chapter 2. Installation and Operation

2.1 INTRODUCTION

The MCP42XX PICtail Plus Daughter Board is used to demonstrate the operation of Digital Potentiometer. The operation of the MCP41XX devices is similar to the MCP42XX devices. Therefore, this demo board can be used as a development platform for either device family.

This board is designed to be used in conjunction with either the PIC24 Explorer 16 Demo Board or the PICkit™ Serial Analyzer.

2.2 FEATURES

This board supports the following features

- Each digital potentiometers Terminal A pin can be individually connected to either AV_{DD} or the corresponding V_{Ax} pad
- Each digital potentiometers Terminal B pin can be individually connected to either AV_{SS} or the corresponding V_{Bx} pad
- Can control the voltage on the MCP4261's CS pin to either V_{SS} , 3.3V, 5.0V, or 9.0V via control signals from the PICtail Plus interface (J3)
- Can Control the MCP4261 via the PICkit™ Serial Analyzer interface (J1)
- PIC24 can monitor the voltage levels of the MCP4261's W0 and W1 pins
- Supplied with a "C" program that demonstrates normal and high voltage commands
- Demonstrates a split rail application, with digital logic at 3.3V and analog operation at 5.0V

MCP42XX PICtail™ Plus Daughter Board User's Guide

2.3 GETTING STARTED

Figure 2-1 shows a simplified circuit for the MCP42XX PICtail Plus Daughter Board. The layout of the board is shown in Figure 2-3. This board can be operated with either a PICDEM board with a PICtail Plus header or the PICkit Serial Analyzer. The MCP42XX PICtail Plus Daughter Board kit comes with firmware for the Explorer 16 Starter Kit (DV164033). The layout of this board is shown in Figure 2-5.

The MCP42XX PICtail Plus Daughter Board supports the following Microchip Digital Potentiometer devices; which allows demonstration of all MCP42XX devices

- MCP42X1

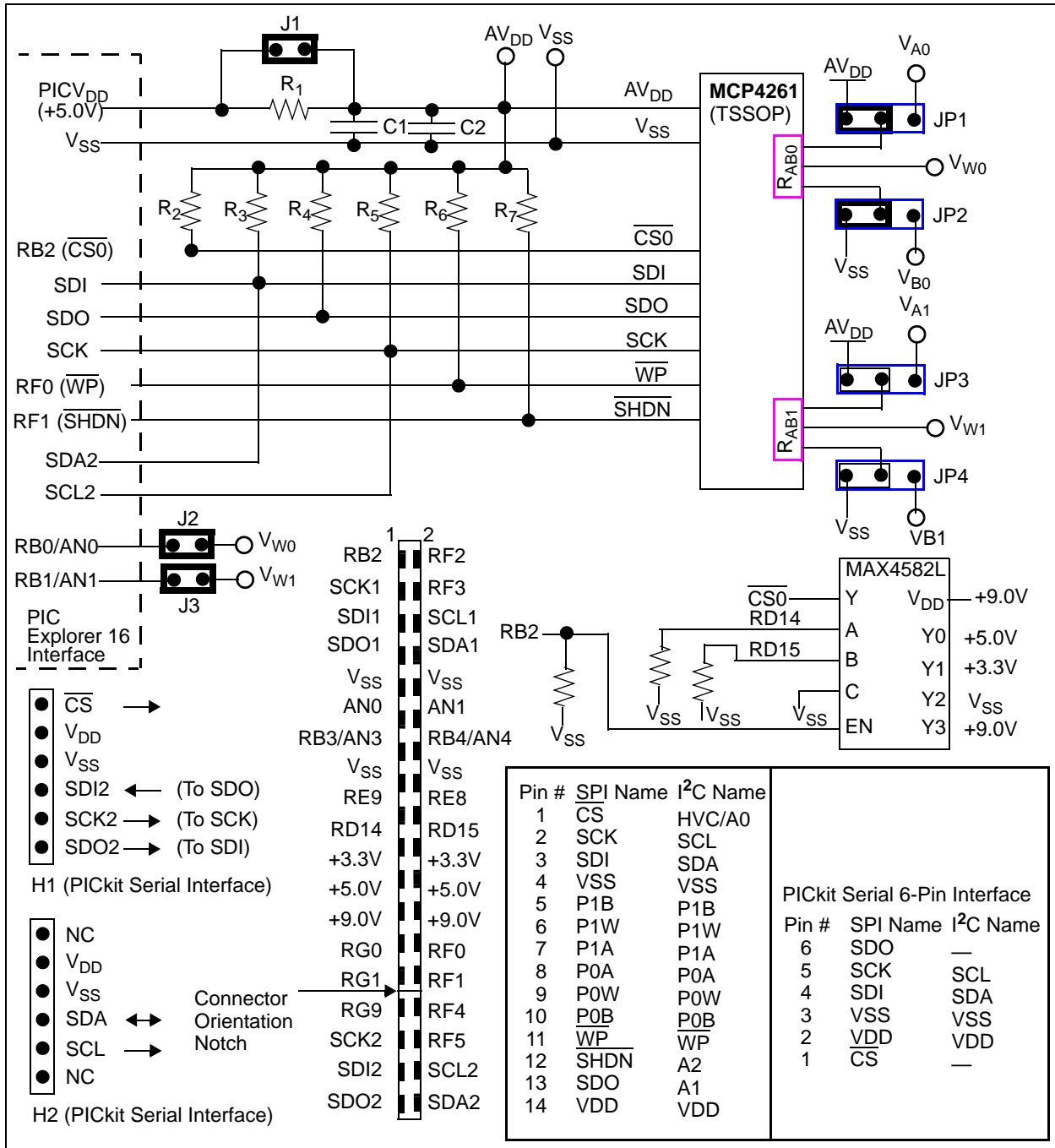

FIGURE 2-1: MCP41XX Simplified Circuit.

2.3.1 The Hardware

Figure 2-2 shows the component placement of the MCP42XX PICtail Plus Daughter Board as well as the operation of the board jumpers.

The VAx and VBx pads allow an external voltage source to be applied to the device's desired Terminal A or Terminal B pin. The VWx pad is directly connected to the corresponding Terminal W pin, which makes it easy to measure the resulting voltage. The AVDD pad allows an external power supply to power the board, which should improve performance compared to powering the board via the PICtail Plus header or the PICkit Serial Analyzer.

The Printed Circuit Board (PCB) has been designed for the support of the SPI and I²C device families (MCP42XX and MCP46XX), so not all components are installed for the SPI version of the demo board.

2.3.1.1 JUMPER DESCRIPTIONS

Figure 2-2 shows the function of the demo board jumpers. Some of the jumpers configure the voltage source of the Terminal A and Terminal B pins while others determine the connection of the W pins. Lastly there is a jumper to ensure that drive conflicts do not occur if an external power supply is being used for the AVDD voltage.

The default jumper configuration for the shipped demo board is shown in Figure 2-3.

MCP42XX PICtail™ Plus Daughter Board User's Guide

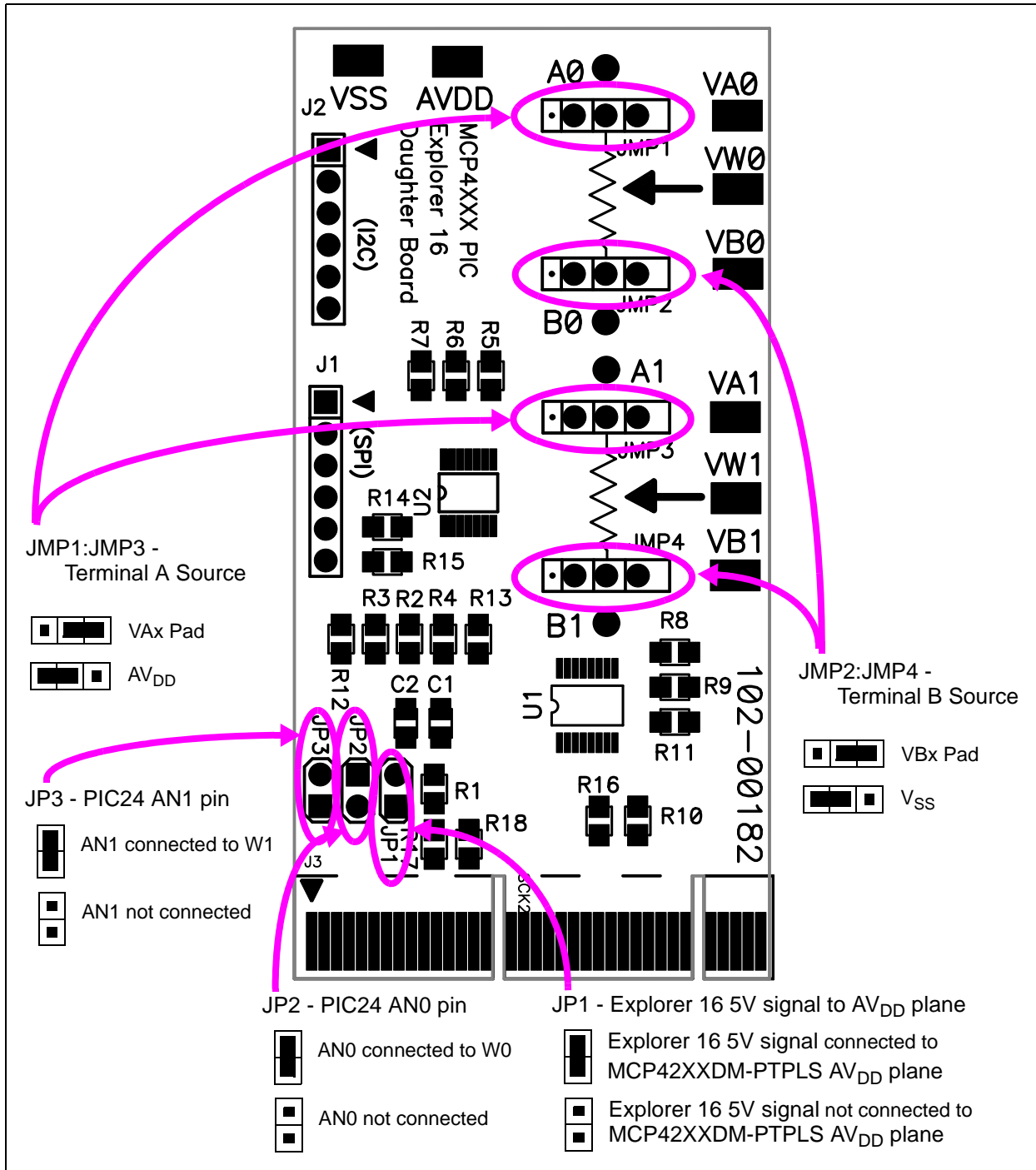

FIGURE 2-2: MCP42XXDM-PTPLS Jumper Configuration and Oscilloscope Test Points.

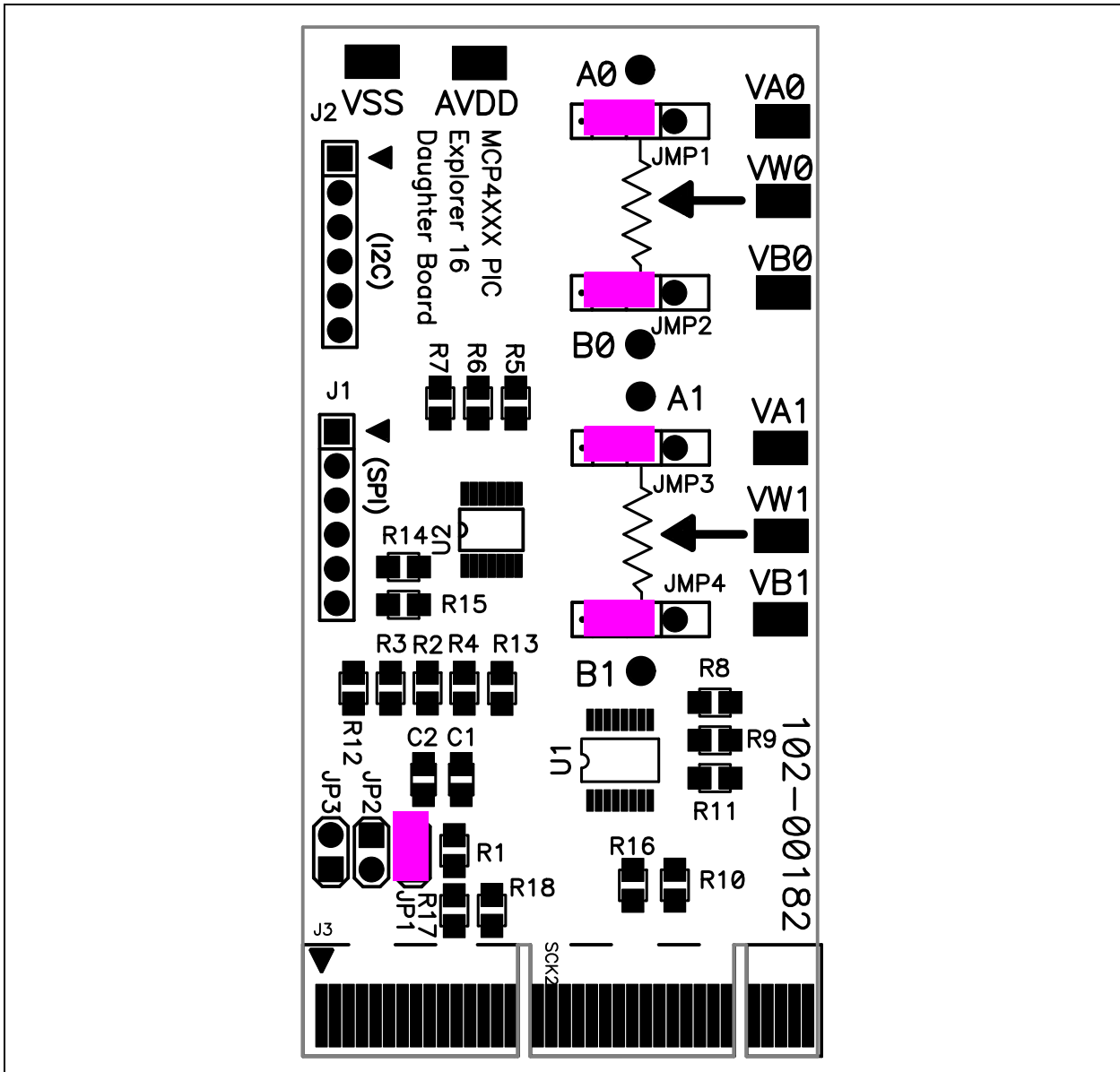

FIGURE 2-3: MCP42XX PICtail Plus Daughter Board Layout with Default Jumper Settings

Note: This is the Jumper configuration that the board should be shipped with.

MCP42XX PICtail™ Plus Daughter Board User's Guide

2.4 EXPLORER 16 DAUGHTER DEMO BOARD DEMOS

This section describes how to demonstrate the MCP42XX PICtail Plus Daughter Board. The demos will either use an Explorer 16 Developers Board or a PICkit Serial Analyzer.

The demo using the Explorer 16 Developers Board is discussed in **Section 2.4.1 “Demos with the Explorer 16 Starter Kit”**. While the demo using the PICkit Serial Analyzer is discussed in **Section 2.4.2 “Demo with the PICkit Serial Analyzer”**.

Note: Both demos require that the MCP42XXDM-PTPLS board jumper settings are as shown in Figure 2-4.

2.4.1 Demos with the Explorer 16 Starter Kit

Note: For information on how to use the MPLAB-IDE, ICD-2, or any other aspect of the PIC Development tool platform, please refer to the appropriate documentation.

This Demo will use the Explorer 16 Starter Kit. This board needs to be programmed with the supplied firmware. This firmware can be found on the included CD-ROM or can be downloaded from the Microchip web site. It is good practice to check the Microchip web site for updates to the demo firmware.

The supplied firmware program has two modes of operation. In the first mode, the program generates a saw wave on the VW1 pin (see Figure 2-6). The second mode is to display the operation of High Voltage commands to Wiper 1 (see Figure 2-7). This is where the \overline{CS} signal is driven to 9V.

The program selected is determined after a reset (including the Power-on reset) by the state of the S3 switch. The programs are:

- Wiper 1 Saw Wave (Switch S3 not depressed)
- Increment / Decrement with High Voltage Write to Non-Volatile Wiper 1 Register (Switch S3 depressed)

Table 2-1 shows the required hardware to operate the demo.

TABLE 2-1: DEMO HARDWARE REQUIREMENTS

Item #	Description	Comment
1	Explorer 16 Developers Board and power supply (DV164033)	Note 1
2	MCP42XXDM-PTPLS	
3	4 Channel oscilloscope	Note 2

Note 1: A development tool to program the Explorer 16 Developers Board is required. This development tool could be Microchip's MPLAB ICD-2.

2: An oscilloscope with fewer channels can be used, but this will require that the probes be moved between signals to verify the output states. A 2 channel is the minimum requirement, but is not recommended.

Installation and Operation

2.4.1.1 THE MCP42XXDM-PTPS JUMPER CONFIGURATION

Before inserting the board into the Explorer 16 Developers Board, the jumper configuration must be verified. Figure 2-4 shows the configurations of the jumpers.

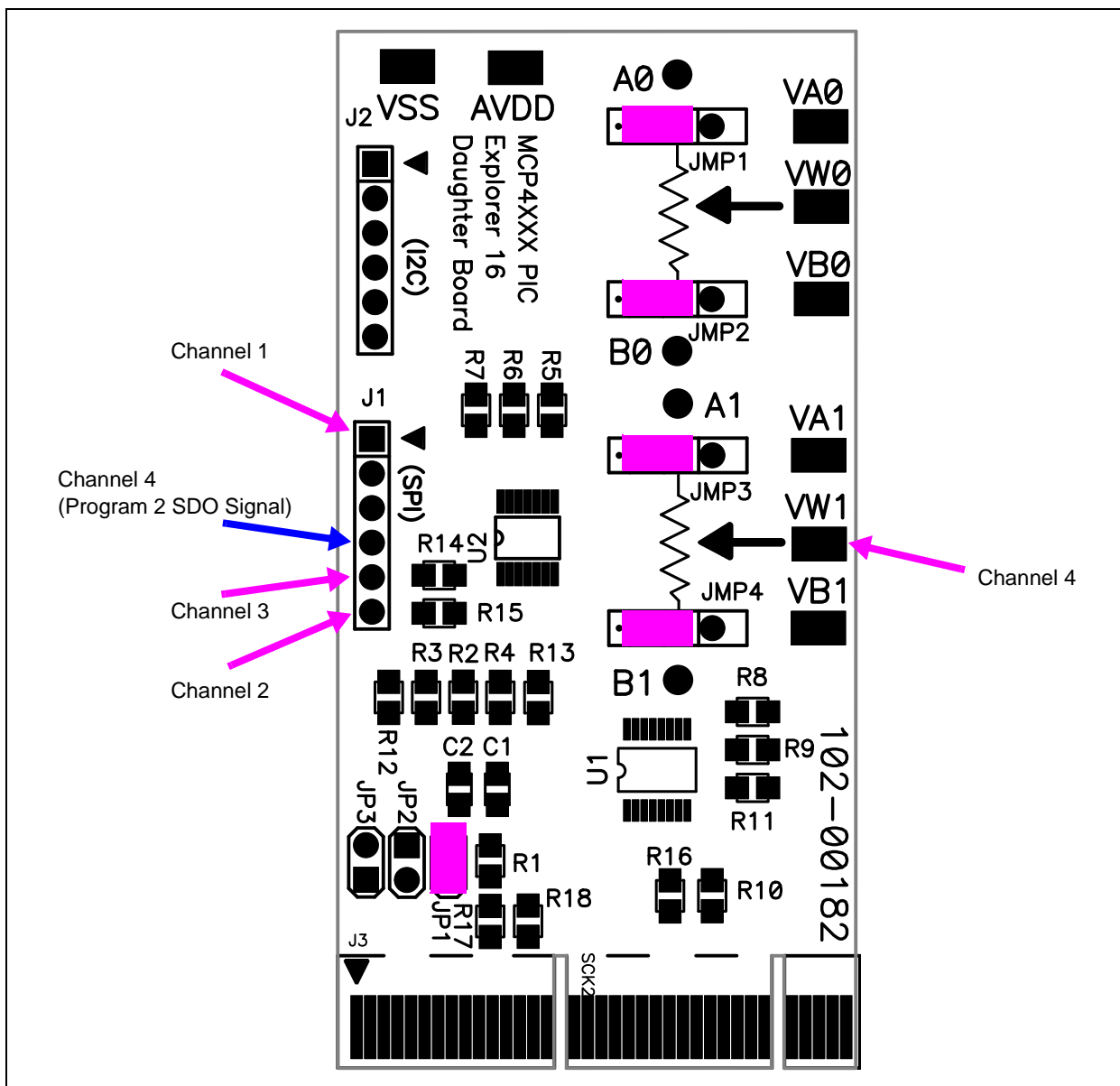

FIGURE 2-4: MCP4XXDM-PTPLS Jumper Configuration and Oscilloscope Test Points.

Note: This is the Jumper configuration that the board should be shipped with.

MCP42XX PICtail™ Plus Daughter Board User's Guide

2.4.1.2 MCP42XX PICTAIL PLUS DAUGHTER BOARD (MCP42XXDM-PTPLS) INTO THE EXPLORER 16 STARTER KIT (DV164033)

Figure 2-5 shows the component placement on the Explorer 16 Demo Board including the PICtail Plus header that the MCP42XX PICtail Plus Daughter Board is inserted into. The boards Reset switch and other switches are pointed out.

Ensure that the MCP42XXDM-PTPLS is installed in the correct orientation into the Explorer 16 Developers Board. Figure 2-5 shows the location where the daughter board is inserted into the Explorer 16 Developers Board.

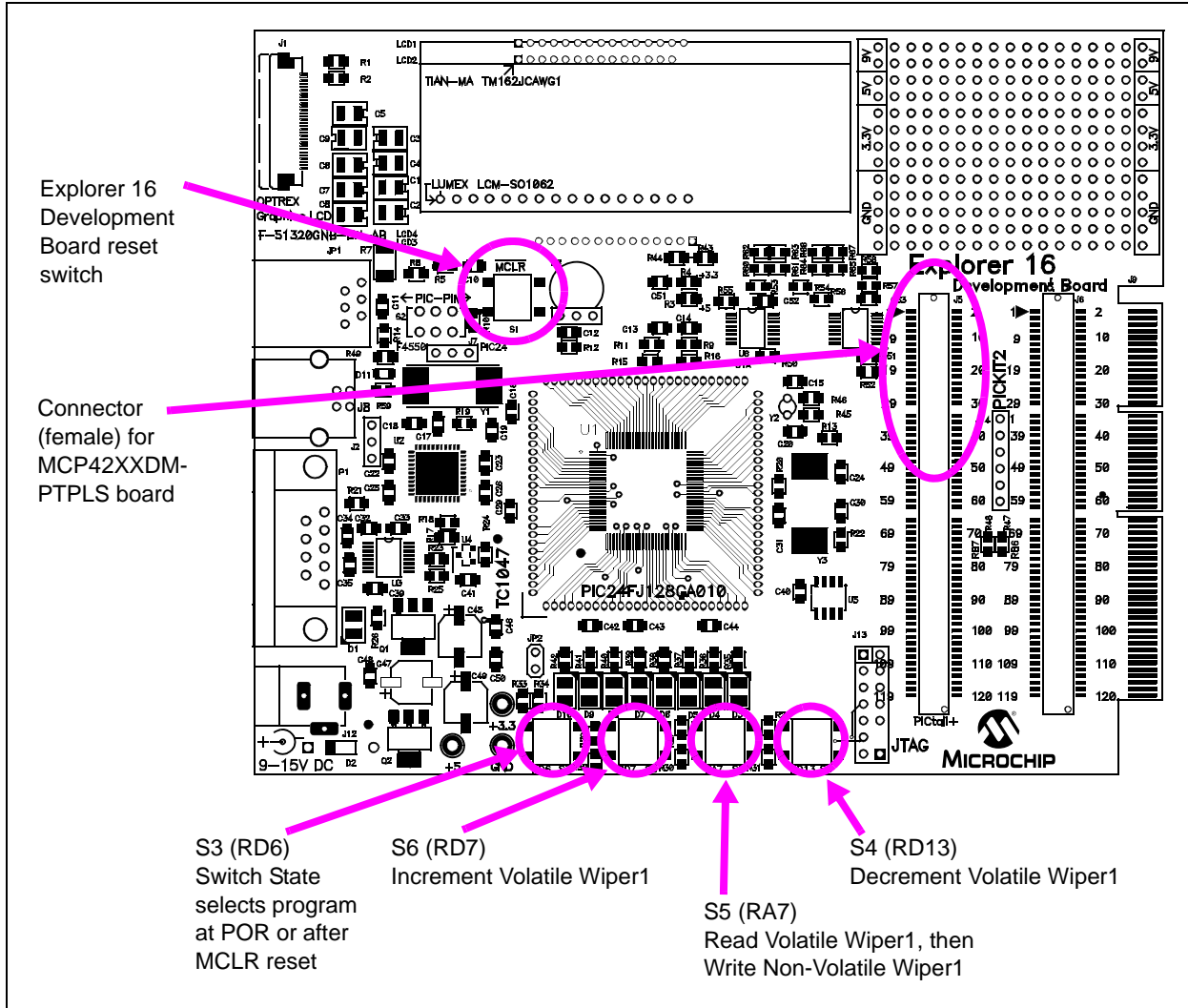

FIGURE 2-5: Explorer 16 Development Board (DV164033).

2.4.1.3 DEMO STEPS

The PIC24 Board firmware contains two programs. The program selected is determined after a reset (including the Power-on reset) by the state of the S3 switch. The programs are:

1. Wiper 1 Saw Wave (Switch S3 not depressed).
2. Increment / Decrement with High Voltage Write to Non-Volatile Wiper 1 Register (Switch S3 depressed).

Table 2-2 shows the sequence of steps to demo the MCP42XXDM-PTPLS board with the Explorer 16 Developer's Board.

Figure 2-6 shows the expected output waveform for Program #1 (Wiper 1 Saw Wave) as well as the voltage levels and ranges of the four signals. Figure 2-7 shows an example waveforms for the High Voltage Write Command for the SDI, SDO, SCK, and \overline{CS} signals.

TABLE 2-2: DEMO STEPS USING THE PICDEM HPC EXPLORER DEMO BOARD

Step	Action	Result
1a	Turn on oscilloscope and configure as follows: <ul style="list-style-type: none"> • Channel 1, 2, 3, and 4 @ 5V/Division • Channel 1 to 4 have same ground reference point 	—
1b	Configure oscilloscope as follows: <ul style="list-style-type: none"> • Time-base = 100 ms/Division (see Figure 2-6 for scope details) 	—
2	Configure the MCP42XXDM-PTPLS to the jumper settings shown in Figure 2-4.	—
3	Insert the MCP42XXDM-PTPLS board into the Explorer 16 Developers Board J5 header (see Figure 2-5). Ensure proper orientation of Daughter Board to J5 Header.	—
4	Connect the oscilloscope probes as follows: <ul style="list-style-type: none"> • Channel 1 to the \overline{CS} Pin of Header J1 • Channel 2 to the SDI Pin of Header J1 • Channel 3 to the SCK Pin of Header J1 • Channel 4 to the VW1 Pad 	—
5	Power up the programmed Explorer 16 Developer Board and depress and release the MCLR push button	Program 1 is now selected. Output waveform should look similar to Figure 2-6. Ensure to verify voltage levels/ranges of the four signals. (Note 1)
6	Depress the Explorer 16 Developer Board's S3 push button	—
7	Depress and release the Explorer 16 Developer Board's MCLR push button	—
8	Release the Explorer 16 Developer Board's S3 push button	Program 2 is now selected.
9	Configure oscilloscope as follows: <ul style="list-style-type: none"> • Time-base = 50 μs/Division (see Figure 2-7 for scope details) 	—

Note 1: The SDI and SCK signals go from V_{SS} to approximately 3.3V due to the PIC24 operating at 3.3V. The VW1 signals go from V_{SS} to approximately 5V.

MCP42XX PICtail™ Plus Daughter Board User's Guide

TABLE 2-2: DEMO STEPS USING THE PICDEM HPC EXPLORER DEMO BOARD (CONTINUED)

Step	Action	Result
10	Depress the Explorer 16 Developer Board's S6 push button	While S6 is depressed, the voltage on Wiper 1 (VW1) increases
11	Depress the Explorer 16 Developer Board's S4 push button	While S4 is depressed, the voltage on Wiper 1 (VW1) decreases
12	Use the S4 and S6 push buttons to configure the volatile wiper 1 register to either near V_{DD} or near VSS. Take note of Wiper Voltage value.	—
13	Move Channel 4 scope probe (VW1) to SDO signal on J1 (see Figure 2-4)	—
14	Configure Scope to Capture on Channel 1 (CS pin) on the rising edge at about 7V.	—
15	Depress the Explorer 16 Developer Board's S5 push button	While S5 is depressed, the volatile Wiper 1 register is read, this value is written to the Non-Volatile Wiper 1 register, and then approximately a 10ms delay occurs while the NV write cycle occurs. Capture will look similar to Figure 2-7 (Note 1)
16	Unplug Power from the Explorer 16 Developer Board	—
17	Depress the Explorer 16 Developer Board's S3 push button	—
18	Power up the programmed Explorer 16 Developer Board and depress and release the MCLR push button	—
19	Release the Explorer 16 Developer Board's S3 push button	The voltage on the Wiper 1 pad (VW1) should be the same voltage level as when completed with Step 12.
20	Unplug Power from the Explorer 16 Developer Board and remove the MCP42XXDM-PTPLS board	—

Note 1: The SDI and SCK signals go from V_{SS} to approximately 3.3V due to the PIC24 operating at 3.3V. The VW1 signals go from V_{SS} to approximately 5V.

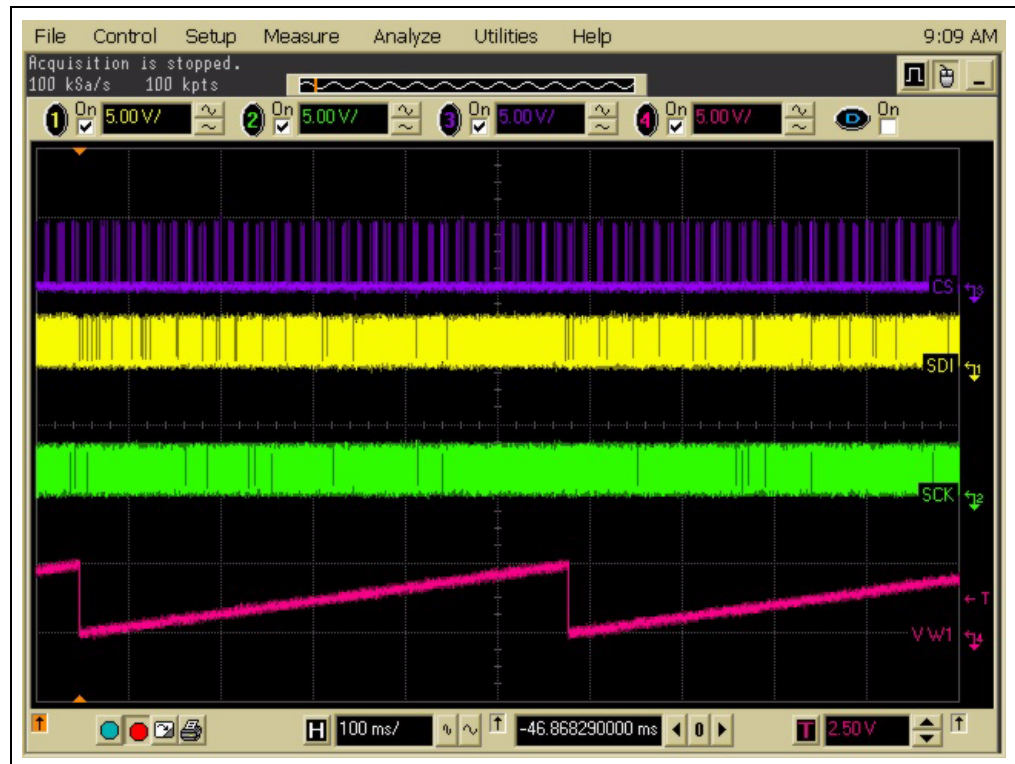

FIGURE 2-6: Screen Capture of Program 1 Output Waveforms.

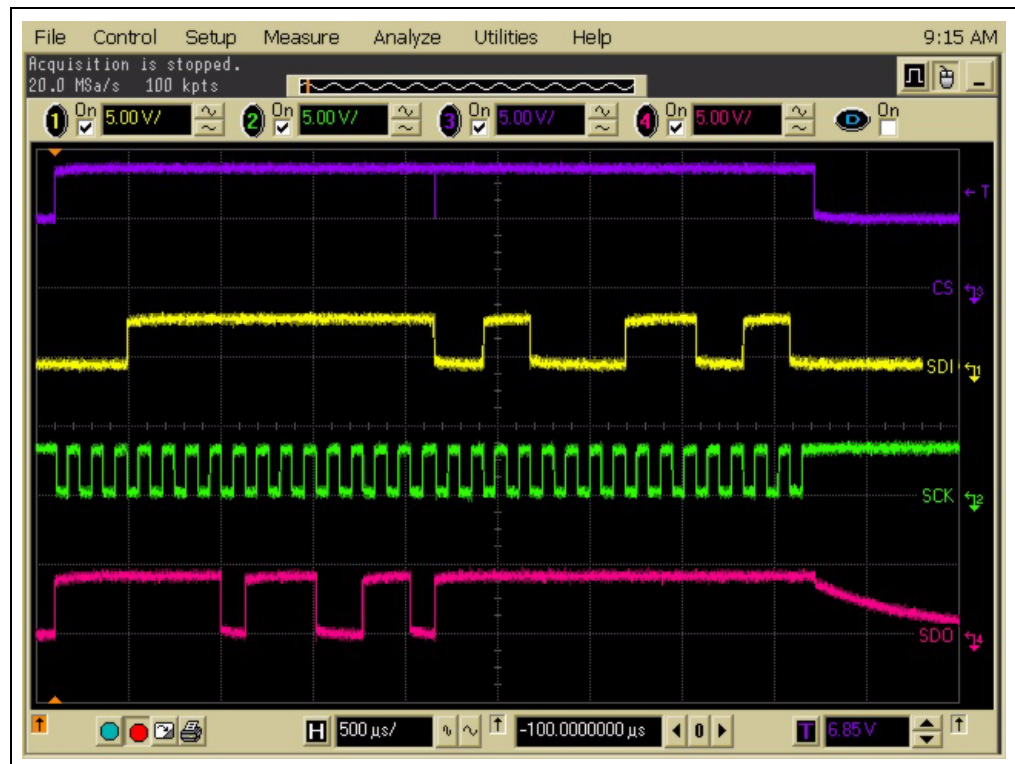

FIGURE 2-7: Screen Capture of Program 2 Non-Volatile Write Waveform.

MCP42XX PICtail™ Plus Daughter Board User's Guide

2.4.2 Demo with the PICkit Serial Analyzer

Note: For information on how to use the PICkit Serial Analyzer, or any other aspect of the PIC® Development tool platform, please refer to the appropriate documentation.

This demo requires that you have previously installed the PICkit Serial Analyzer (DV164122) on your computer. Ensure that the device has properly been installed before using the Supplied GUI for the MCP41XX/42XX devices.

Note 1: The GUI is supplied “As Is”, and the source code is supplied to allow developers a starting point for any GUI development.

2: The GUI will be updated to include the selection of I²C devices (MCP45XX/46XX).

The GUI requires two files, these are:

- DigipotControl.exe
- PICkitS.dll

The “PICkitS.dll” file must be in the same directory as the application executable file.

Table 2-3 shows the required hardware to operate the demo.

TABLE 2-3: DEMO HARDWARE REQUIREMENTS

Item #	Description	Comment
1	PC with USB port running Windows XP	
2	PICkit Serial Analyzer Adapter (DV164122)	
3	MCP42XXDM-PTPLS	
4	Oscilloscope	Note 1

Note 1: A Digital Multi-Meter (DMM) may be used to measure the W pins voltage.

2.4.2.1 THE GUI SCREENS AND GUI CONFIGURATION

Figure 2-8 shows the GUI when the application is first started.

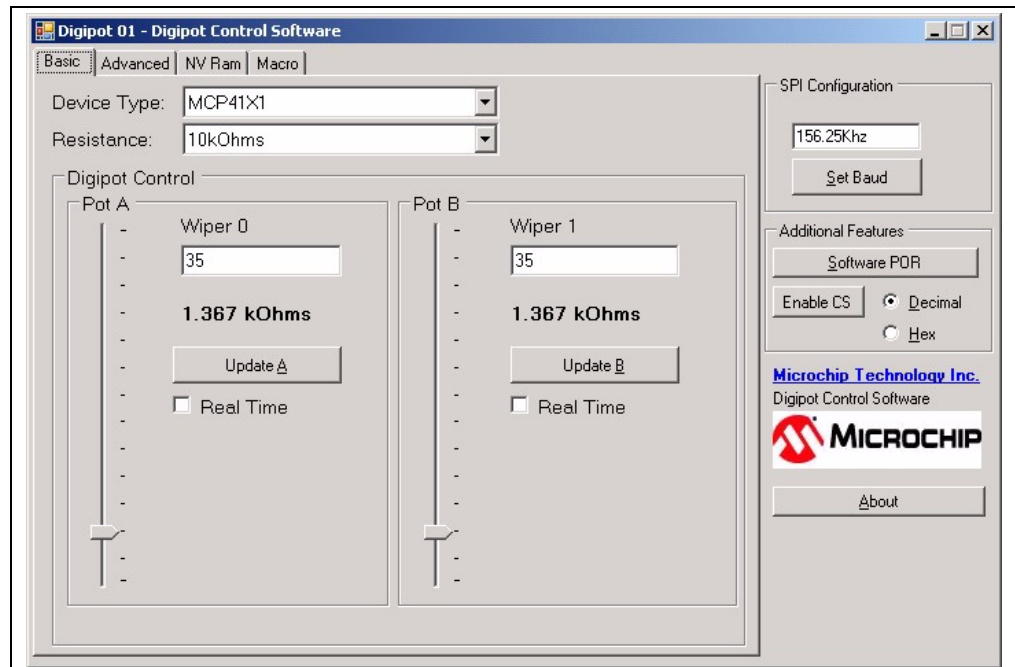

FIGURE 2-8: 1st Screen of GUI.

Figure 2-9 shows the GUI box where the SPI Baud Rate is specified. Clicking on the “Set Baud” button results in an actual Baud Rate of 9.62 kHz, as shown in Figure 2-10. This reflects the actual Baud Rate based on the PICKit Serial Analyzer’s clock frequency.

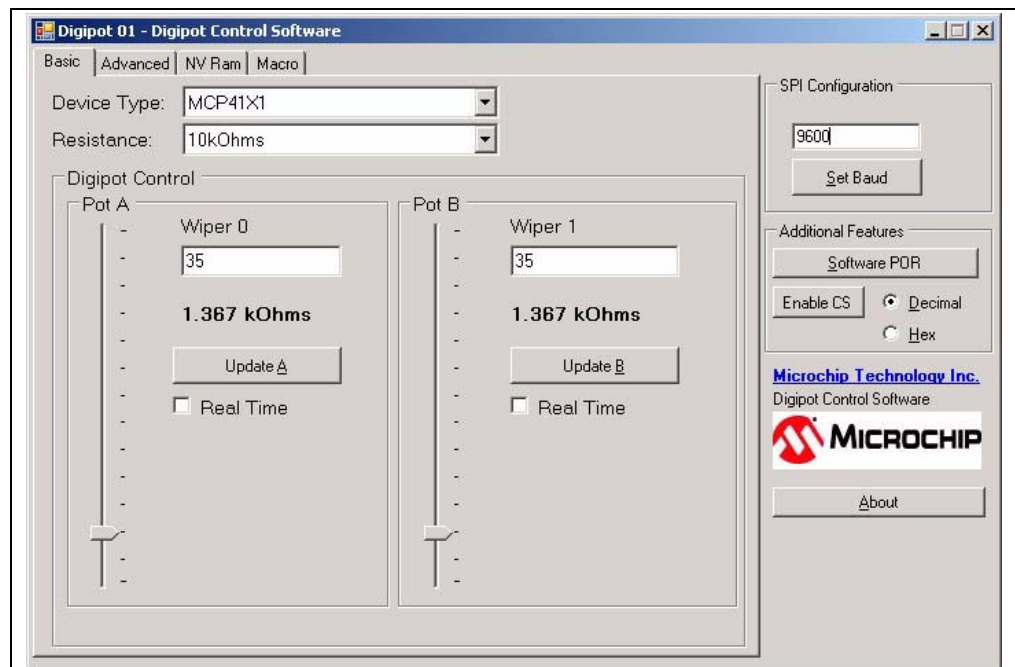

FIGURE 2-9: Configuring the Baud Rate - Desired Baud Rate.

MCP42XX PICtail™ Plus Daughter Board User's Guide

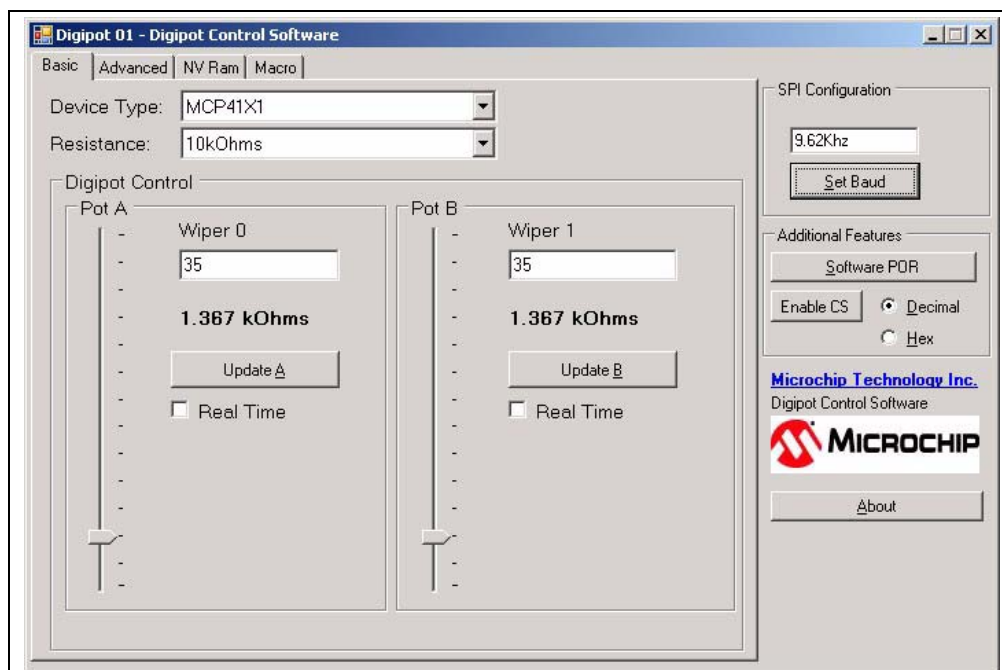

FIGURE 2-10: Configuring the Baud Rate - Actual Baud Rate.

To display the data values in hexadecimal, click on the Hex radial button. To Chip Select the MCP42XX device, click on the “Disable CS” button. The GUI window will now look like Figure 2-11. To have access to more control of the MCP42XX memory, click on the Advanced tab, and the GUI will display Figure 2-12.

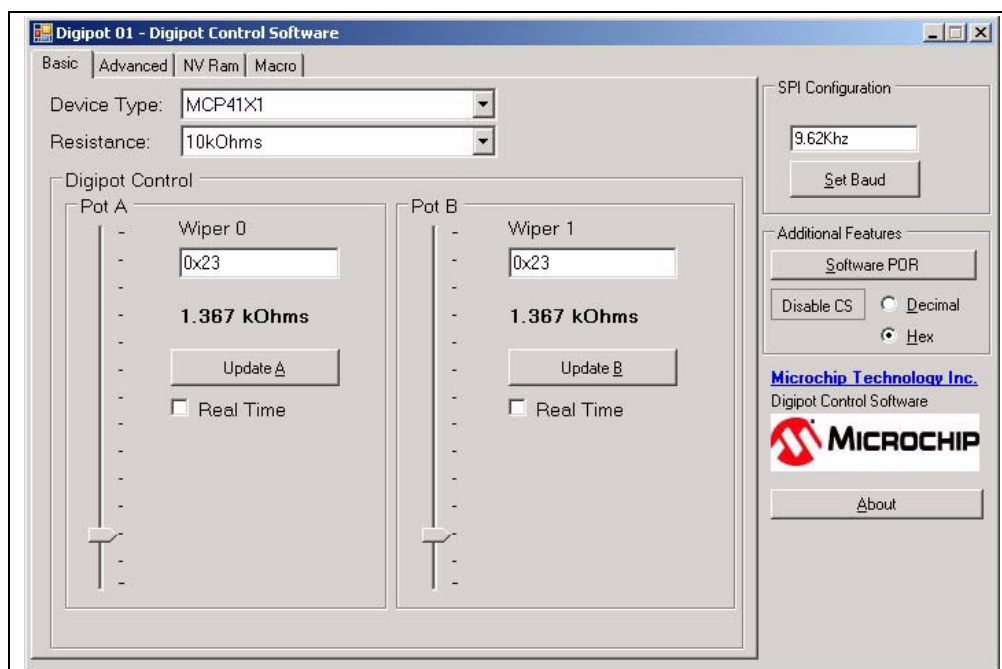

FIGURE 2-11: Enabling The MCP42XX Chip Select.

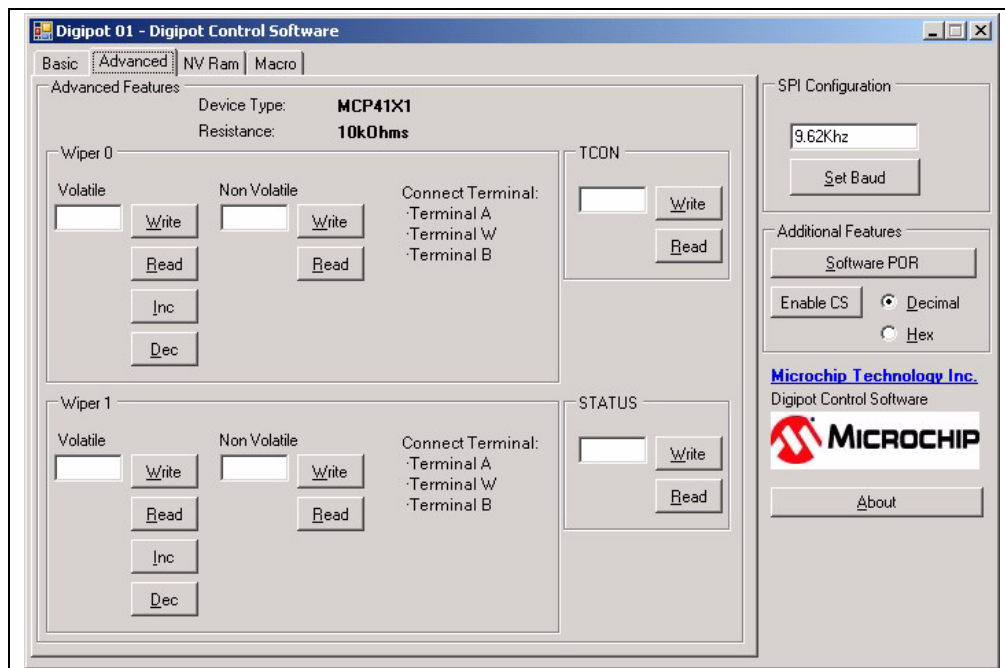

FIGURE 2-12: Advance Screen.

Clicking on the Read Button should display the register values shown in Figure 2-13. The volatile wiper value should match the Non-volatile wiper value.

Note: The Volatile/Non-Volatile wiper values may not be the device's expected Mid-scale value due to board production testing.

To write to a desired register, in the desired data entry box and click on the Write button. Figure 2-14 shows an example of writing to the Volatile Wiper 0 register.

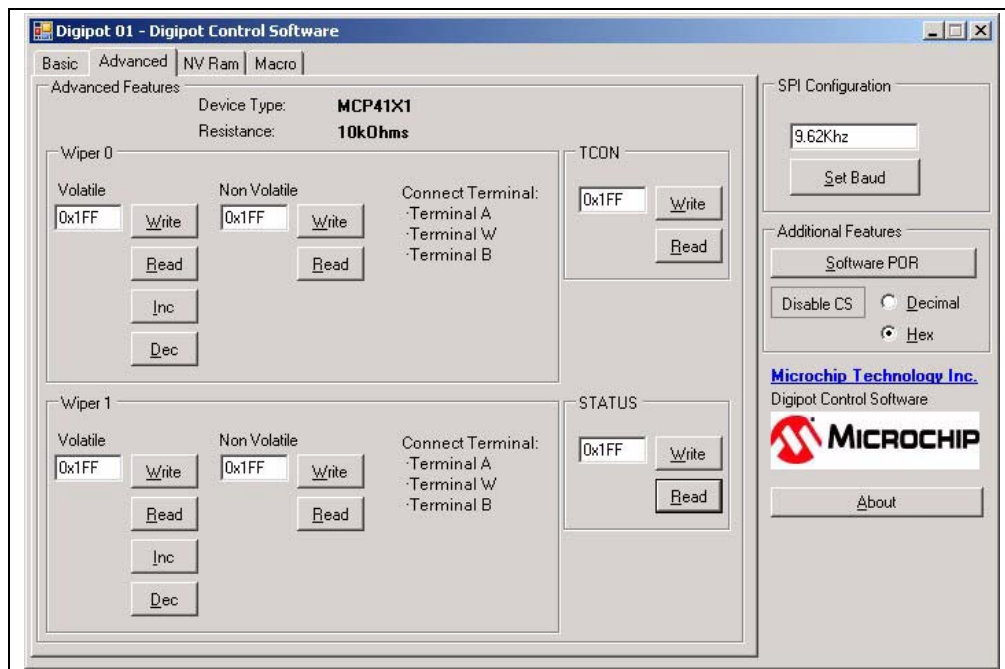

FIGURE 2-13: Advance Screen - Read Register.

MCP42XX PICtail™ Plus Daughter Board User's Guide

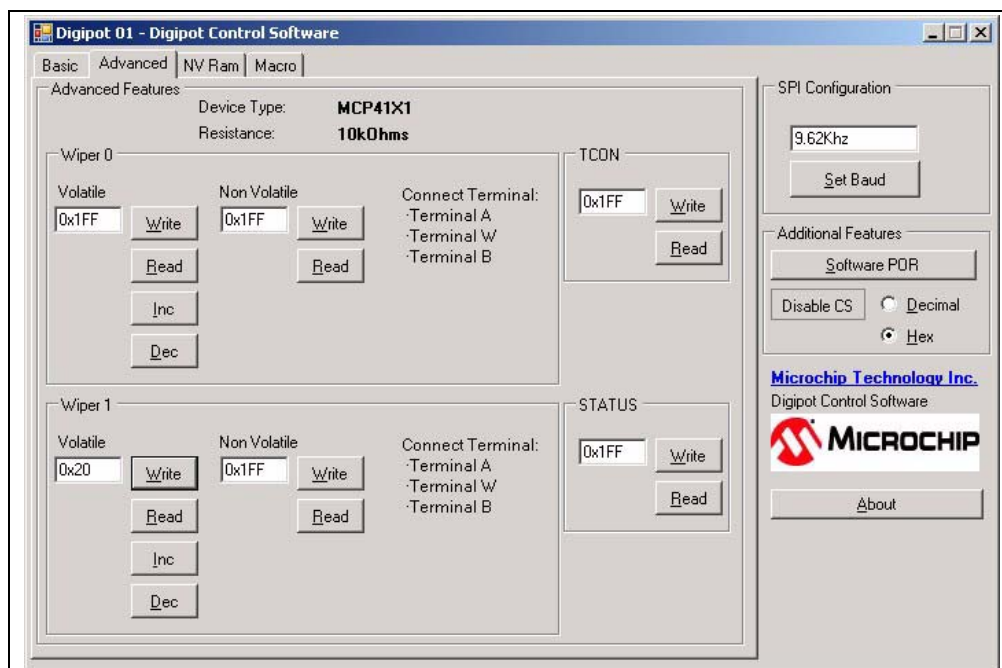

FIGURE 2-14: Advance Screen - Write Register.

Installation and Operation

Figure 2-15 shows the connections for the Demo using the PICkit Serial Analyzer.

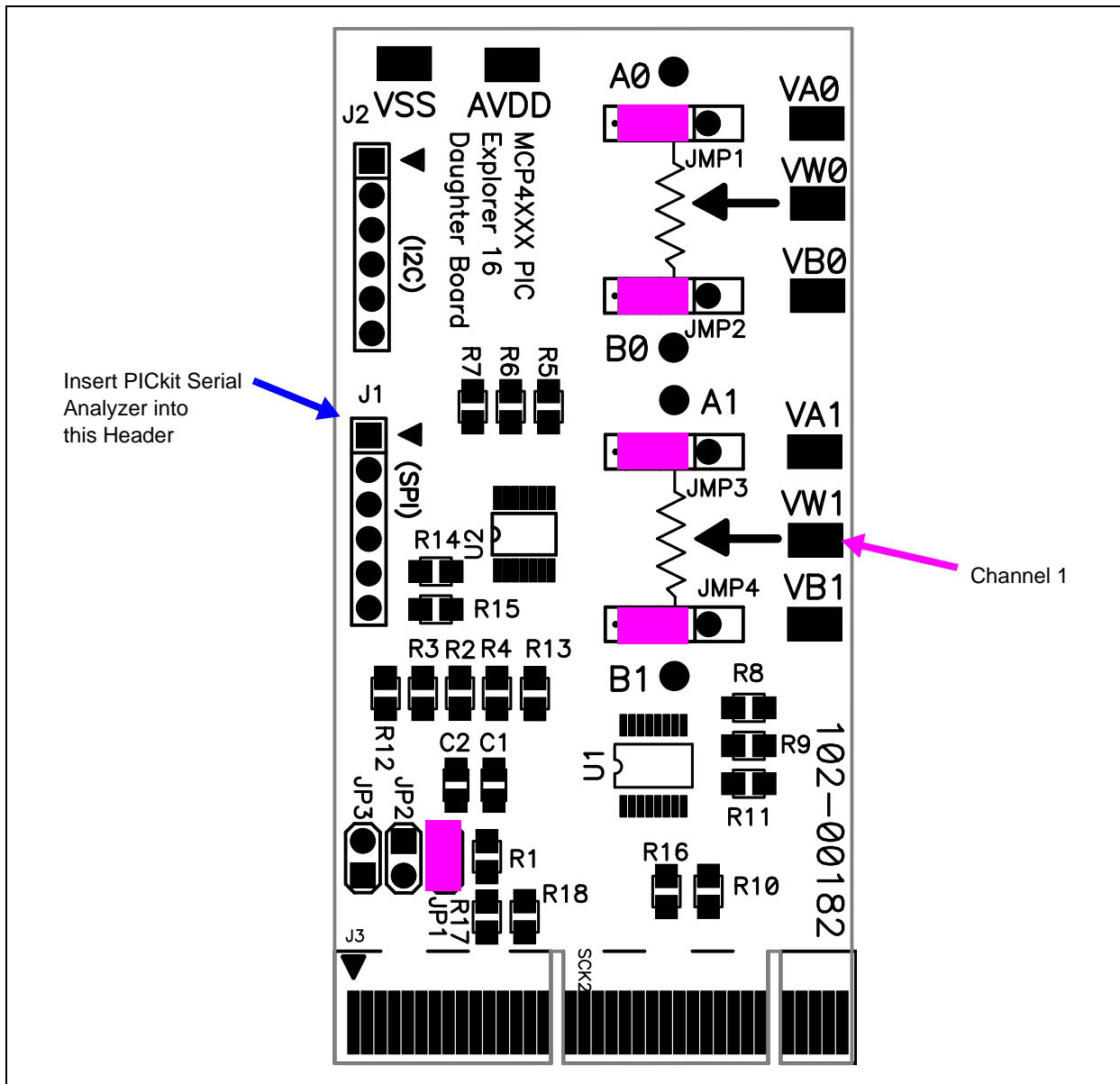

FIGURE 2-15: PICkit Serial Analyzer Demo Jumper Configuration and Oscilloscope Test Points.

MCP42XX PICtail™ Plus Daughter Board User's Guide

2.4.2.2 DEMO STEPS

The use of the PICkit Serial Analyzer means that wiper pin's voltage is under direct control from the PC's GUI interface and more user experimentation is possible.

TABLE 2-4: DEMO STEPS USING THE PICDEM HPC EXPLORER DEMO BOARD

Step	Action	Result
1a	Turn on oscilloscope and configure as follows: <ul style="list-style-type: none">• Channel 1 @ 1V/Division (Note 1)	—
1b	Configure oscilloscope as follows: <ul style="list-style-type: none">• Time-base = 100 μs/Division (Note 1)	—
2	Configure the MCP42XXDM-PTPLS to the jumper settings shown in Figure 2-15.	—
3	Insert the PICkit Serial Analyzer into the MCP42XXDM-PTPLS board's J1 header. Ensure proper orientation of the PICkit Serial Analyzer to the J1 Header.	—
4	Connect the oscilloscope probes as follows: <ul style="list-style-type: none">• Channel 1 to the VW1 Pad	—
5	Plug the PICkit Serial into the PC's USB port	—
6	Plug the PICkit Serial into the MCP42XXDM-PTPLS board's J1 connector	The MCP42XXDM-PTPLS board is now powered
7	Start the GUI application	See Figure 2-8 and
8	Select a Baud rate of 9600	See Figure 2-9 and Figure 2-10
9	Under Additional Features, select the "Hex" radial button and then Click on the "Enable CS" button. This drives the CS signal low. This Enables the MCP42XX to receive serial commands.	See Figure 2-11. The button's text changes to "Disable CS"
10	Click on the "Advanced" tab	The Advanced screen appears, see Figure 2-12
11	Click on all 6 "Read" buttons	See Figure 2-13
12	In the Volatile Wiper 1 register text box, type a value that is significantly different than the current value. Such as, if the value was 1FFh, type 20h.	See Figure 2-14
13	Click on the associated "Write" button	The VW1 voltage (on the oscilloscope) changes.
14	Type other values and then click on the "Write" button to see how the VW1 voltage changes	Look on the oscilloscope to monitor the Wiper 1 voltage after each click of the "Write" button.
15	In the Wiper 1 text box, type 080h (mid-scale)	The VW1 pin should go to $AV_{DD} / 2$

Note 1: A Digital Multi-Meter (DMM) configured to measure voltage may be used instead of an oscilloscope.

TABLE 2-4: DEMO STEPS USING THE PICDEM HPC EXPLORER DEMO BOARD (CONTINUED)

Step	Action	Result												
16	Now write values to the TCON register (bit 7 to bit 4) and monitor the effects on the VW1 pin.	<p>The different Potentiometer terminals (A1, W1, and B1), will be either connected or disconnected depending on the value.</p> <table> <tr> <td>TCON =</td> <td>Result</td> </tr> <tr> <td>'x 1110 xxxx'b</td> <td>B1 open, W1 pulled high</td> </tr> <tr> <td>'x 1011 xxxx'b</td> <td>A1 open, W1 pulled low</td> </tr> <tr> <td>'x 1101 xxxx'b</td> <td>W1 floating</td> </tr> <tr> <td>'x 0111 xxxx'b</td> <td>A1 open, W1 connected to B1 (Zero-Scale)</td> </tr> <tr> <td>'x 1111 xxxx'b</td> <td>All terminals con- nected to their respective pin</td> </tr> </table>	TCON =	Result	'x 1110 xxxx'b	B1 open, W1 pulled high	'x 1011 xxxx'b	A1 open, W1 pulled low	'x 1101 xxxx'b	W1 floating	'x 0111 xxxx'b	A1 open, W1 connected to B1 (Zero-Scale)	'x 1111 xxxx'b	All terminals con- nected to their respective pin
TCON =	Result													
'x 1110 xxxx'b	B1 open, W1 pulled high													
'x 1011 xxxx'b	A1 open, W1 pulled low													
'x 1101 xxxx'b	W1 floating													
'x 0111 xxxx'b	A1 open, W1 connected to B1 (Zero-Scale)													
'x 1111 xxxx'b	All terminals con- nected to their respective pin													
17	Write assorted values to the devices memory locations and then read the values to see what is present. If the write is to Non-Volatile memory, power down (unplug) the MCP42XX PICtail Plus Daughter Board and then power up to evaluate if the non-volatile memory value is retained.													

Note 1: A Digital Multi-Meter (DMM) configured to measure voltage may be used instead of an oscilloscope.

MCP42XX PICtail™ Plus Daughter Board User's Guide

NOTES:

Appendix A. Schematic and Layouts

A.1 INTRODUCTION

This appendix contains the schematics and layouts for the MCP42XX PICtail Plus Daughter Board. Diagrams included in this appendix:

- Board - Schematic
- Board - Top Silk-screen Layer
- Board - Top Component Plus Silk-screen
- Board - Ground Layer
- Board - Power Layer
- Board - Bottom Layer

A.2 SCHEMATICS AND PCB LAYOUT

Figure A.3 shows the schematic of the MCP42XX PICtail Plus Daughter Board.

Figure A.4 shows the layout for the top layer of the MCP42XX PICtail Plus Daughter Board. The layer order is shown in Figure A-1.

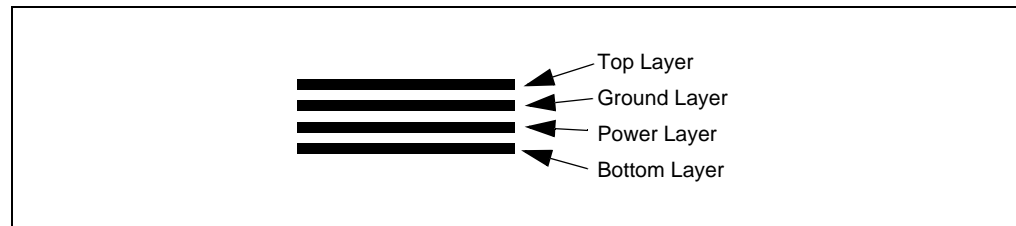
FIGURE A-1: LAYER ORDER

MCP42XX PICtail™ Plus Daughter Board User's Guide

A.3 BOARD - SCHEMATIC

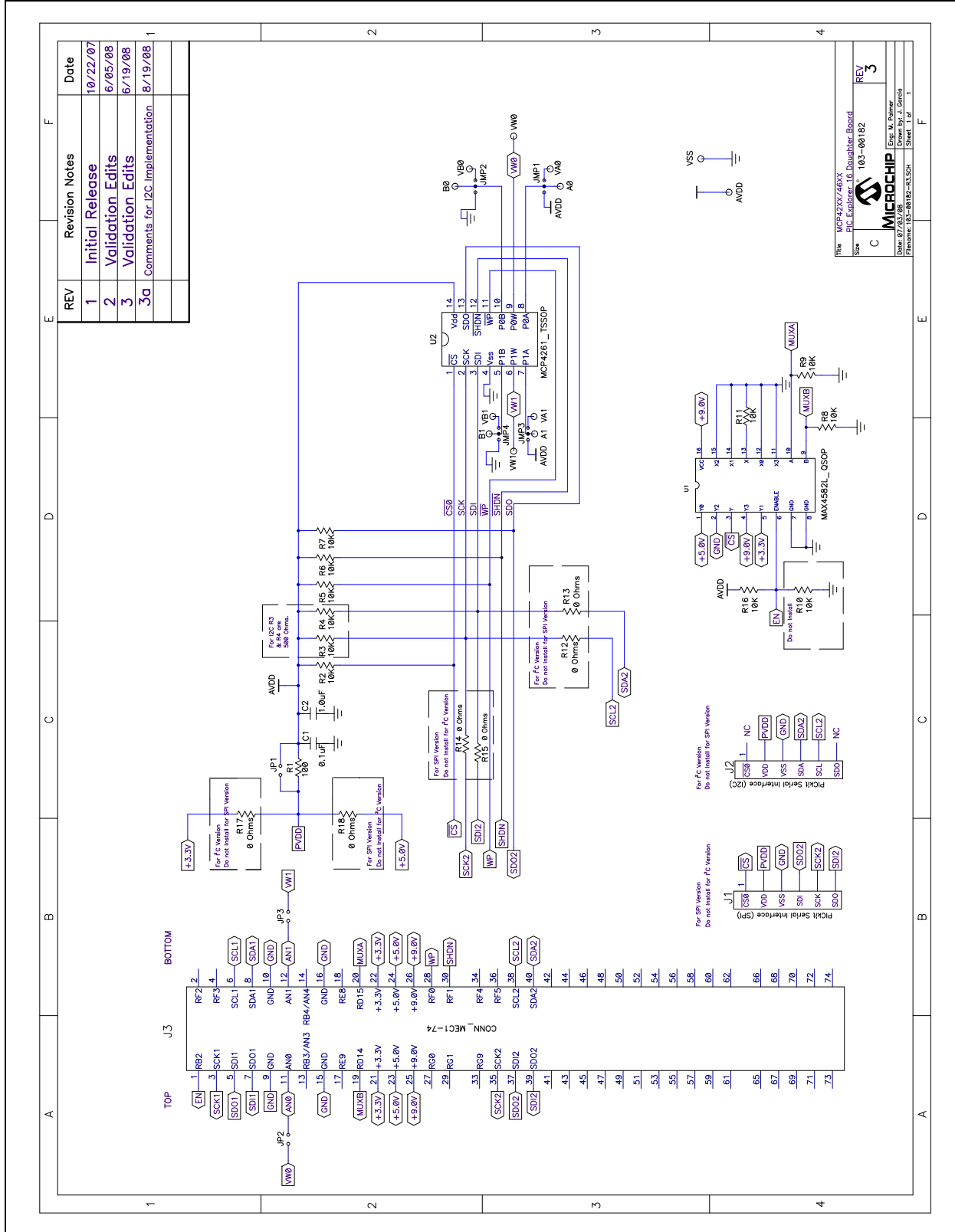

A.4 BOARD – TOP SILK-SCREEN LAYER

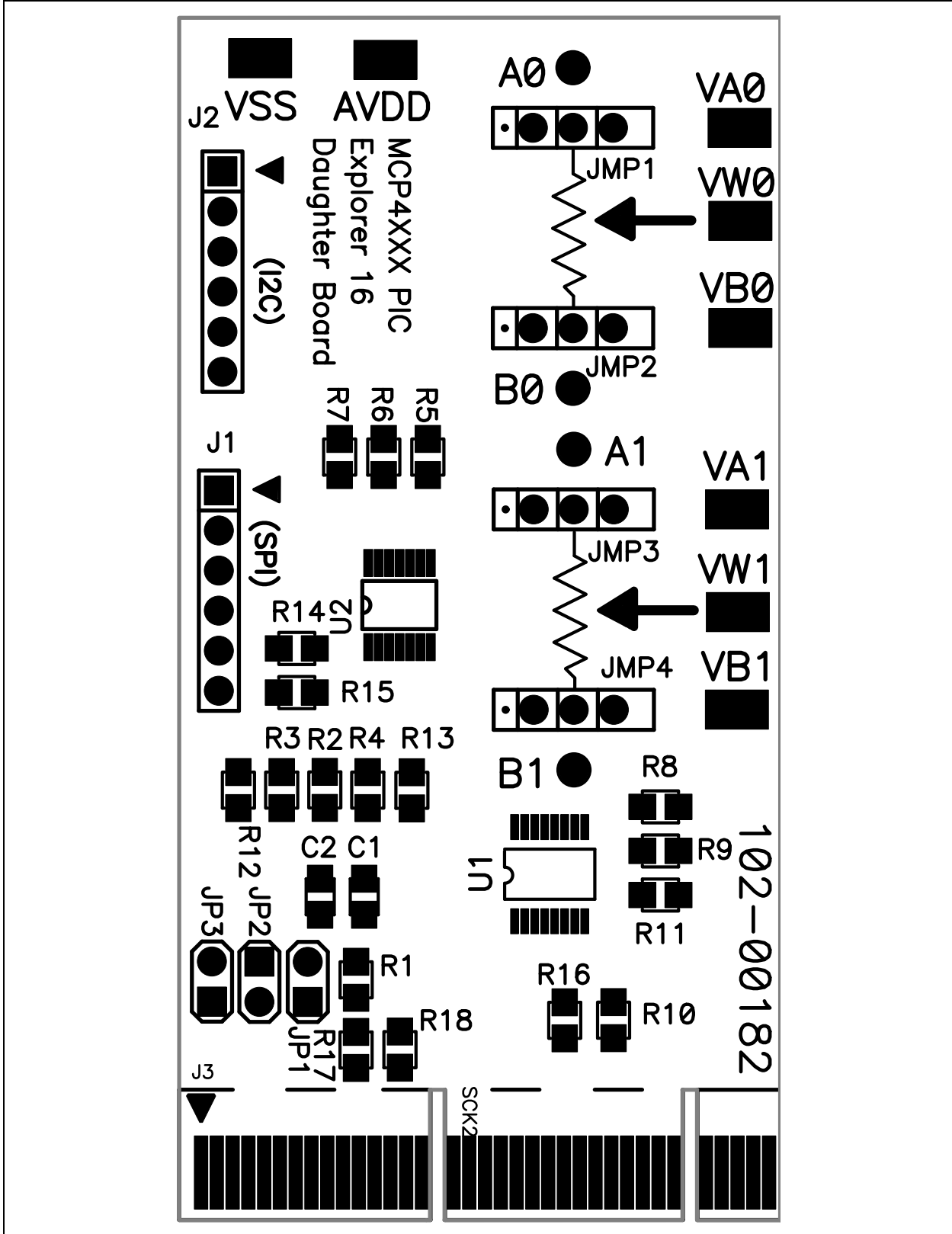

A.6 BOARD – GROUND LAYER

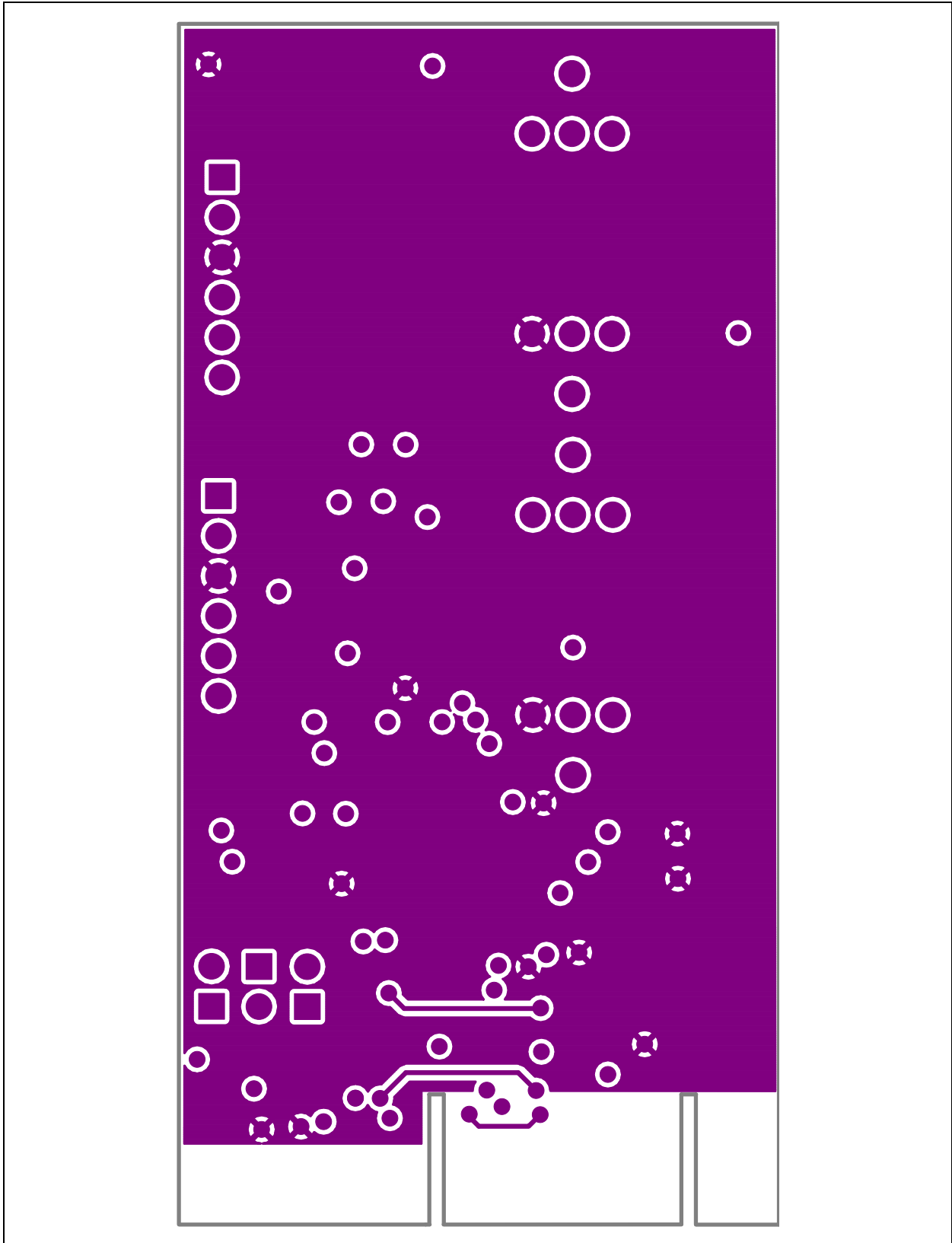

MCP42XX PICtail™ Plus Daughter Board User's Guide

A.7 BOARD – POWER LAYER

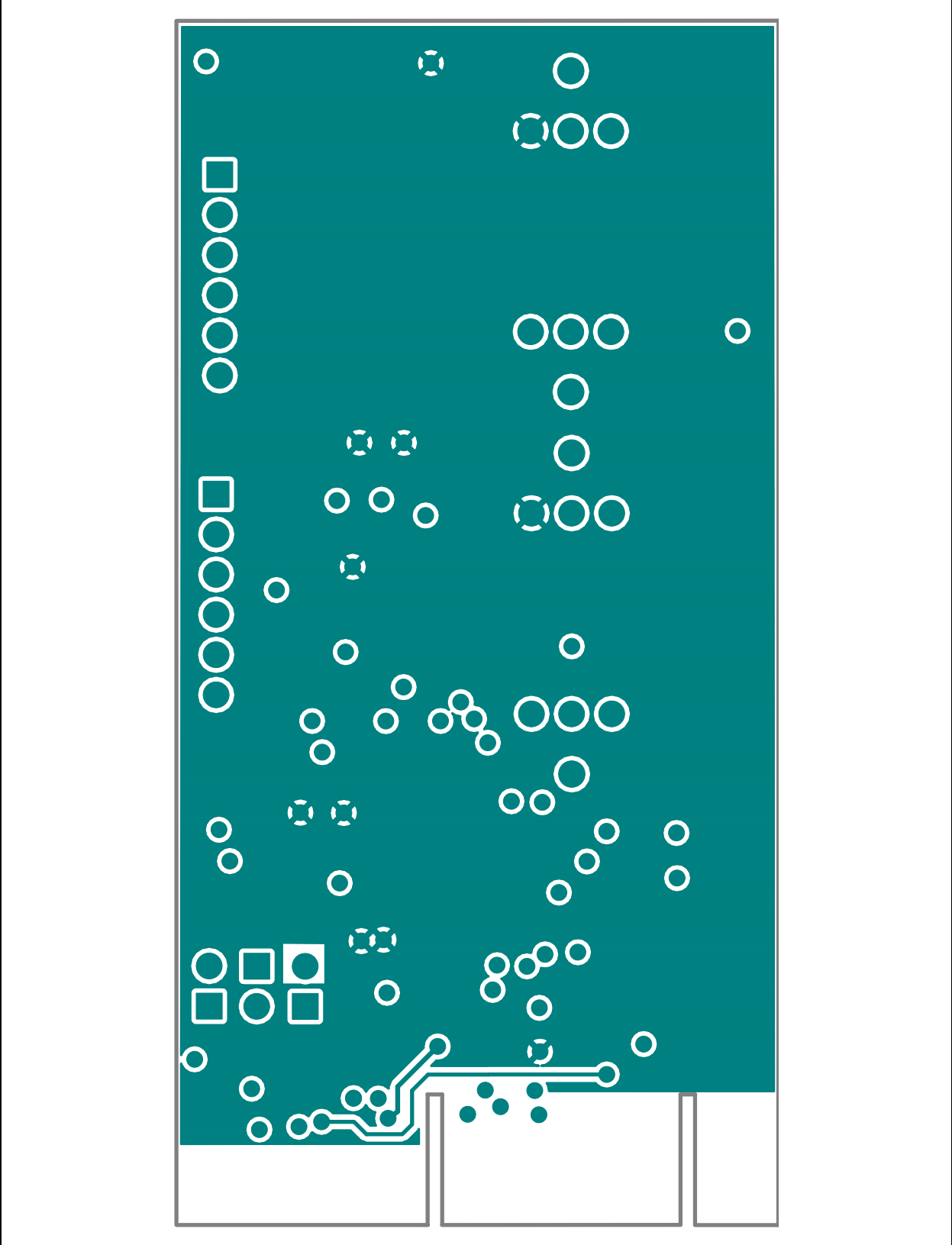

A.8 BOARD – BOTTOM LAYER

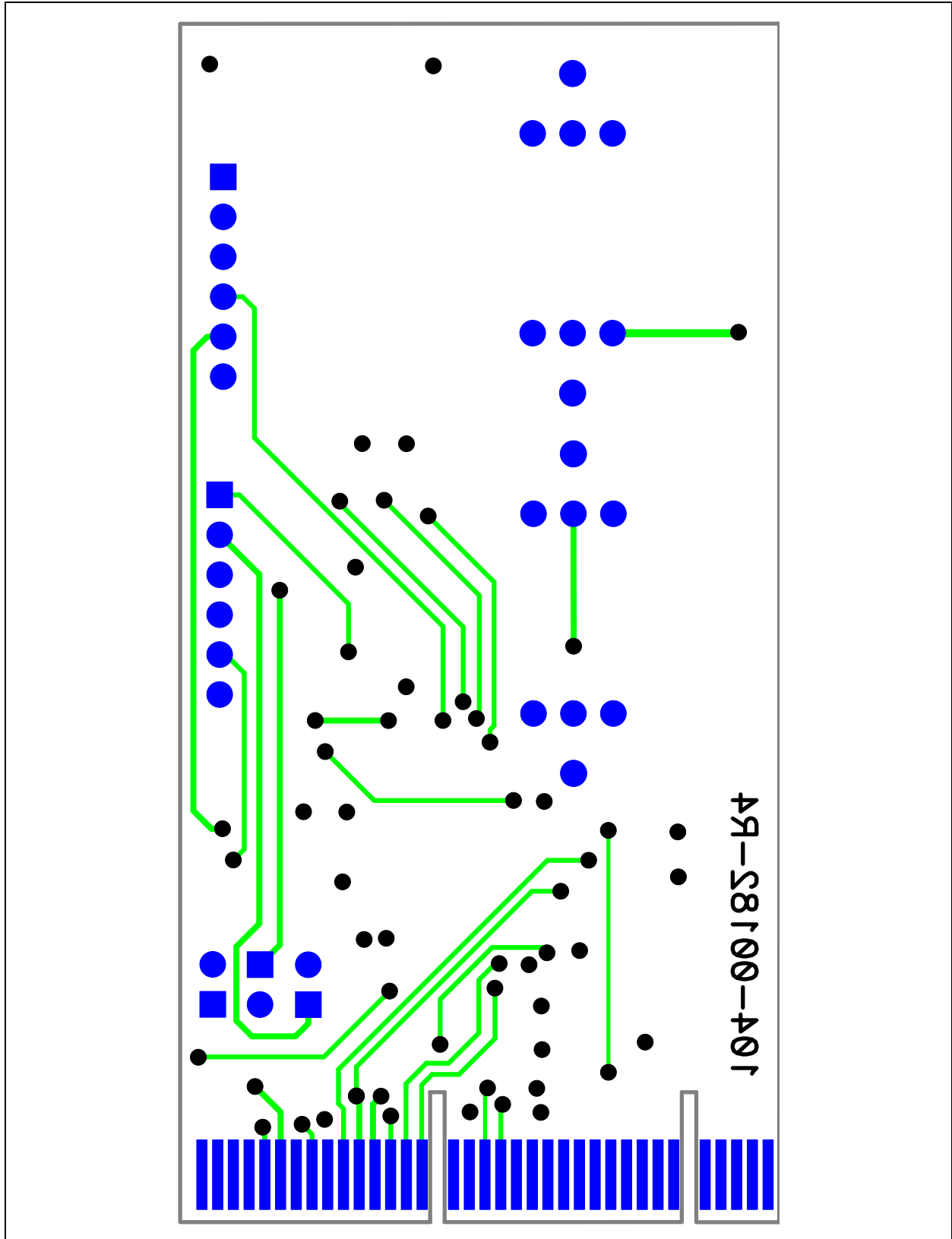

MCP42XX PICtail™ Plus Daughter Board User's Guide

NOTES:



MCP42XX PICTAIL™ PLUS DAUGHTER BOARD USER'S GUIDE

Appendix B. Bill Of Materials (BOM)

TABLE B-1: BILL OF MATERIALS (BOM)

Qty	Reference	Description	Manufacturer	Part Number
1	C1	CAP .1UF 25V CERAMIC X7R 0805	Panasonic® - ECG	ECJ-2VB1E104K
1	C2	CAP 1.0UF 16V CERAMIC X7R 0805	Kemet® Electronics	C0805C105K4RACTU
1	J1	CONN HEADER 6POS .100 VERT TIN	Molex/Waldom® Electronics Corp	22-28-4060
3	JP1, JP2, JP3	CONN HEADER 2POS .100 VERT TIN	Molex/Waldom Electronics	22-03-2021
4	JMP1, JMP2, JMP3, JMP4	CONN HEADER 3POS .100" STR TIN	Molex/Waldom Electronics Corp	90120-0123
1	PCB	RoHS Compliant Bare PCB, MCP4XXX PICTail Plus Daughter Board	Microchip Technology Inc.	104-00182
1	R1	RES 100 OHM 1/8W 1% 0805 SMD	Panasonic - ECG	ERJ-6ENF1000V
10	R2, R3, R4, R5, R6, R7, R8, R9, R11, R16	RES 10.0K OHM 1/8W 1% 0805 SMD	Panasonic - ECG	ERJ-6ENF1002V
3	R14, R15, R18	RES 0.0 OHM 1/8W 5% 0805 SMD	Rohm	MCR10EZPJ000
1	U1	C,ANALOG MUX,DUAL,4-CHAN- NEL,CMOS,SSOP,16PIN,PLASTIC 16-QSOP	Maxim	MAX4582LEEE
1	U2	MCP414X/416X/424, 7/8-Bit Single/Dual SPI Digital POT with Non-Volatile Mem- ory	Microchip Technology Inc.	MCP4261T-103E/ST
12	VA0, VW0, VB0, VA1, VW1, VB1, VSS, AVDD	PC TEST POINT COMPACT SMT	Keystone Electronics®	5016

Note 1: The components listed in this Bill of Materials are representative of the PCB assembly. The released BOM used in manufacturing uses all RoHS-compliant components.

TABLE B-2: BILL OF MATERIALS — COMPONENTS NOT INSTALLED

Qty	Reference	Description	Manufacturer	Part Number
0	J2	DO NOT POPULATE CONN HEADER 6POS .100 VERT TIN	—	—
0	R10, R12, R13, R17	DO NOT POPULATE	—	—

Note 1: The components listed in this Bill of Materials are representative of the PCB assembly. The released BOM used in manufacturing uses all RoHS-compliant components.

MCP42XX PICtail™ Plus Daughter Board User's Guide

NOTES:

Appendix C. Board Testing

C.1 INTRODUCTION

The MCP42XX PICtail Plus Daughter Board can be used in multiple configurations. Only a subset of these configurations are tested. The tests were performed with the configuration shown in Figure C-1. The tested nodes are Channel 1 through Channel 4. Other configurations, Pad connections, and circuit performance are not tested.

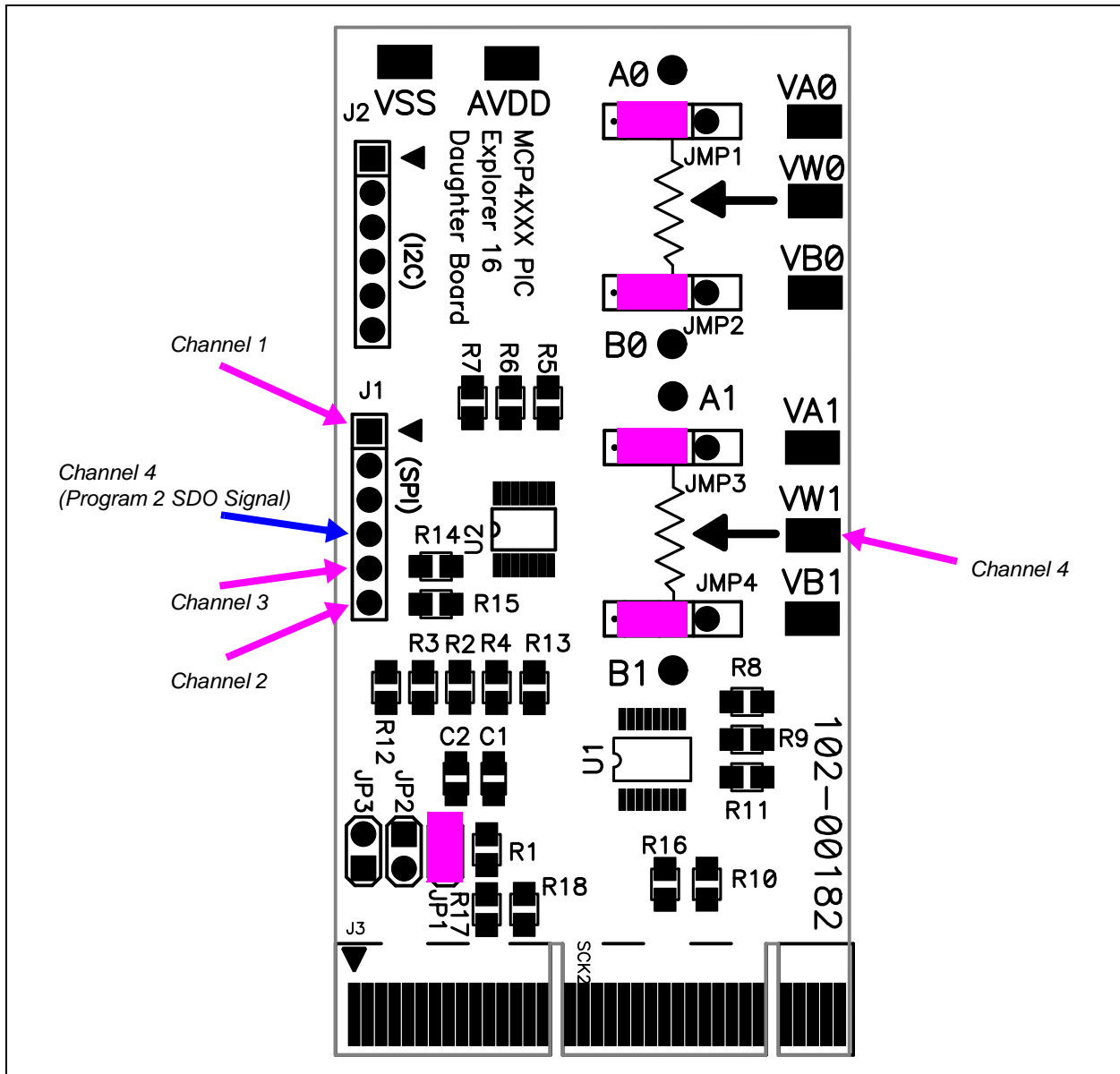

FIGURE C-1: Tested Jumper Configuration and Test Points.

MCP42XX PICtail™ Plus Daughter Board User's Guide

C.2 WHAT IS TESTED

The following portions of the board are tested:

- MCP4261 (U2)
 - U2 MCP4261 Pot 1 is tested in Potentiometer configuration.
- JMP3 (P1 – P2) - AVDD to P1A
- JMP4 (P1 – P2) - AVSS to P1B
- MAX4582 (U1)
 - Y0 (5.0V), Y3 (9.0V), and Y2 (VSS) switching.
- Pads: VW1

C.3 WHAT IS NOT TESTED

The following portions of the board are NOT tested:

- JMP1
- JMP2
- JMP3 (P2 – P3) - VA1 to P1A
- JMP4 (P2 – P3) - VB1 to P1B
- Jumpers: JP1, JP2, and JP3
- MAX4582 (U1)
 - Y1 (3.3V) switching.
- J1: PICkit Serial Analyzer Interface (SPI)
- J2: PICkit Serial Analyzer Interface (I²C)
- Pads: VA0, VB0, VW0, VA1, VB1, AVDD, and VSS
- Test Points: A0, B0, A1, and B1
- Connections to unpopulated components

NOTES:



WORLDWIDE SALES AND SERVICE

AMERICAS

Corporate Office

2355 West Chandler Blvd.
Chandler, AZ 85224-6199
Tel: 480-792-7200
Fax: 480-792-7277
Technical Support:
<http://support.microchip.com>
Web Address:
www.microchip.com

Atlanta

Duluth, GA
Tel: 678-957-9614
Fax: 678-957-1455

Boston

Westborough, MA
Tel: 774-760-0087
Fax: 774-760-0088

Chicago

Itasca, IL
Tel: 630-285-0071
Fax: 630-285-0075

Dallas

Addison, TX
Tel: 972-818-7423
Fax: 972-818-2924

Detroit

Farmington Hills, MI
Tel: 248-538-2250
Fax: 248-538-2260

Kokomo

Kokomo, IN
Tel: 765-864-8360
Fax: 765-864-8387

Los Angeles

Mission Viejo, CA
Tel: 949-462-9523
Fax: 949-462-9608

Santa Clara

Santa Clara, CA
Tel: 408-961-6444
Fax: 408-961-6445

Toronto

Mississauga, Ontario,
Canada
Tel: 905-673-0699
Fax: 905-673-6509

ASIA/PACIFIC

Asia Pacific Office

Suites 3707-14, 37th Floor
Tower 6, The Gateway
Harbour City, Kowloon
Hong Kong
Tel: 852-2401-1200
Fax: 852-2401-3431

Australia - Sydney

Tel: 61-2-9868-6733
Fax: 61-2-9868-6755

China - Beijing

Tel: 86-10-8528-2100
Fax: 86-10-8528-2104

China - Chengdu

Tel: 86-28-8665-5511
Fax: 86-28-8665-7889

China - Hong Kong SAR

Tel: 852-2401-1200
Fax: 852-2401-3431

China - Nanjing

Tel: 86-25-8473-2460
Fax: 86-25-8473-2470

China - Qingdao

Tel: 86-532-8502-7355
Fax: 86-532-8502-7205

China - Shanghai

Tel: 86-21-5407-5533
Fax: 86-21-5407-5066

China - Shenyang

Tel: 86-24-2334-2829
Fax: 86-24-2334-2393

China - Shenzhen

Tel: 86-755-8203-2660
Fax: 86-755-8203-1760

China - Wuhan

Tel: 86-27-5980-5300
Fax: 86-27-5980-5118

China - Xiamen

Tel: 86-592-2388138
Fax: 86-592-2388130

China - Xian

Tel: 86-29-8833-7252
Fax: 86-29-8833-7256

China - Zhuhai

Tel: 86-756-3210040
Fax: 86-756-3210049

ASIA/PACIFIC

India - Bangalore

Tel: 91-80-4182-8400
Fax: 91-80-4182-8422

India - New Delhi

Tel: 91-11-4160-8631
Fax: 91-11-4160-8632

India - Pune

Tel: 91-20-2566-1512
Fax: 91-20-2566-1513

Japan - Yokohama

Tel: 81-45-471- 6166
Fax: 81-45-471-6122

Korea - Daegu

Tel: 82-53-744-4301
Fax: 82-53-744-4302

Korea - Seoul

Tel: 82-2-554-7200
Fax: 82-2-558-5932 or
82-2-558-5934

Malaysia - Kuala Lumpur

Tel: 60-3-6201-9857
Fax: 60-3-6201-9859

Malaysia - Penang

Tel: 60-4-227-8870
Fax: 60-4-227-4068

Philippines - Manila

Tel: 63-2-634-9065
Fax: 63-2-634-9069

Singapore

Tel: 65-6334-8870
Fax: 65-6334-8850

Taiwan - Hsin Chu

Tel: 886-3-572-9526
Fax: 886-3-572-6459

Taiwan - Kaohsiung

Tel: 886-7-536-4818
Fax: 886-7-536-4803

Taiwan - Taipei

Tel: 886-2-2500-6610
Fax: 886-2-2508-0102

Thailand - Bangkok

Tel: 66-2-694-1351
Fax: 66-2-694-1350

EUROPE

Austria - Wels

Tel: 43-7242-2244-39
Fax: 43-7242-2244-393

Denmark - Copenhagen

Tel: 45-4450-2828
Fax: 45-4485-2829

France - Paris

Tel: 33-1-69-53-63-20
Fax: 33-1-69-30-90-79

Germany - Munich

Tel: 49-89-627-144-0
Fax: 49-89-627-144-44

Italy - Milan

Tel: 39-0331-742611
Fax: 39-0331-466781

Netherlands - Drunen

Tel: 31-416-690399
Fax: 31-416-690340

Spain - Madrid

Tel: 34-91-708-08-90
Fax: 34-91-708-08-91

UK - Wokingham

Tel: 44-118-921-5869
Fax: 44-118-921-5820

Mouser Electronics

Authorized Distributor

Click to View Pricing, Inventory, Delivery & Lifecycle Information:

[Microchip:](#)

[MCP42XXDM-PTPLS](#)