

# Single Phase Rectifier Bridge

Standard and Avalanche Types

$$I_{dAV} = 18 \text{ A}$$

$$V_{RRM} = 800-1600 \text{ V}$$

$V_{RSM}$ V	$V_{BRmin}$ ① V	$V_{RRM}$ V	Standard Types	Avalanche Types
900		800	VBO 13-08NO2	
1300	1230	1200	VBO 13-12NO2	VBO 13-12AO2
1500	1430	1400	VBO 13-14NO2	VBO 13-14AO2
1700	1630	1600	VBO 13-16NO2	VBO 13-16AO2

① For Avalanche Types only

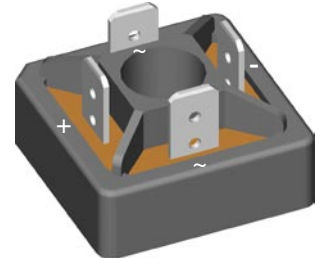
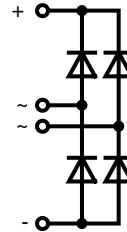

Symbol	Conditions	Maximum Ratings	
$I_{dAV}$ ②	$T_C = 85^\circ\text{C}$ , module	18	A
$I_{dAVM}$	module	30	A
$P_{RSM}$	$T_{VJ} = T_{VJM}$	2.5	kW
$I_{FSM}$	$T_{VJ} = 45^\circ\text{C}$ ; $V_R = 0$	$t = 10 \text{ ms}$ (50 Hz)	220 A
		$t = 8.3 \text{ ms}$ (60 Hz)	230 A
	$T_{VJ} = T_{VJM}$ ; $V_R = 0$	$t = 10 \text{ ms}$ (50 Hz)	180 A
		$t = 8.3 \text{ ms}$ (60 Hz)	190 A
$I^2t$	$T_{VJ} = 45^\circ\text{C}$ ; $V_R = 0$	$t = 10 \text{ ms}$ (50 Hz)	240 A <sup>2</sup> s
		$t = 8.3 \text{ ms}$ (60 Hz)	220 A <sup>2</sup> s
	$T_{VJ} = T_{VJM}$ ; $V_R = 0$	$t = 10 \text{ ms}$ (50 Hz)	160 A <sup>2</sup> s
		$t = 8.3 \text{ ms}$ (60 Hz)	150 A <sup>2</sup> s
$T_{VJ}$		-40...+150	°C
$T_{VJM}$		150	°C
$T_{stg}$		-40...+125	°C
$V_{ISOL}$	50/60 Hz, RMS $t = 1 \text{ min}$ $I_{ISOL} \leq 1 \text{ mA}$ $t = 1 \text{ s}$	3000	V~
		3600	V~
$M_d$	Mounting torque (M5) (10-32 UNF)	1.5-2	Nm
		13-18	lb.in.
<b>Weight</b>	Typ.	15	g

## Features

- Avalanche rated parts available
- Package with DCB ceramic base plate
- Isolation voltage 3600 V~
- Planar passivated chips
- Low forward voltage drop
- ¼" fast-on terminals
- UL registered E 72873

## Applications

- Supplies for DC power equipment
- Input rectifiers for PWM inverter
- Battery DC power supplies
- Field supply for DC motors

## Advantages

- Easy to mount with one screw
- Space and weight savings
- Improved temperature & power cycling

## Dimensions in mm (1 mm = 0.0394")

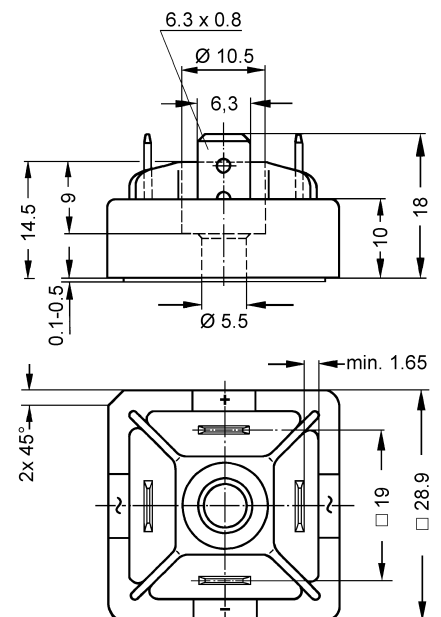

Symbol	Conditions	Characteristic Values	
$I_R$	$V_R = V_{RRM}$ $T_{VJ} = 25^\circ\text{C}$ $T_{VJ} = T_{VJM}$	0.3	mA
		5.0	mA
$V_F$	$I_F = 55 \text{ A}$ $T_{VJ} = 25^\circ\text{C}$	1.8	V
$V_{TO}$	For power-loss calculations only	0.85	V
$r_t$		17	mΩ
$R_{thJC}$	per diode; 120° el.	5.60	K/W
	per module	1.40	K/W
$R_{thCH}$	per diode; 120° el.	6.00	K/W
	per module	1.50	K/W
$d_s$	Creeping distance on surface	13	mm
$d_A$	Creepage distance in air ③	9.5	mm
$a$	Max. allowable acceleration	50	m/s <sup>2</sup>

Data according to IEC 60747 and refer to a single diode unless otherwise stated.

② for resistive load at bridge output

③ with isolated fast-on tabs.

IXYS reserves the right to change limits, test conditions and dimensions.

© IXYS All rights reserved

20070807

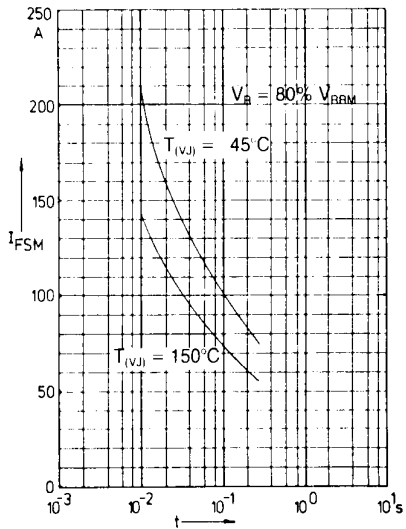

Fig. 1 Surge overload current per diode  
 $I_{FSM}$ : Crest value,  $t$ : duration

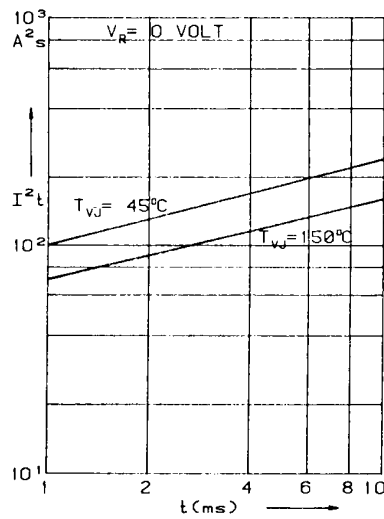

Fig. 2  $I^2t$  versus time (1-10 ms) per diode

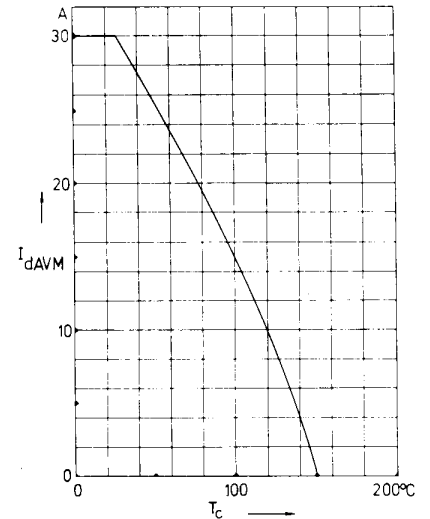

Fig. 3 Max. forward current at case temperature

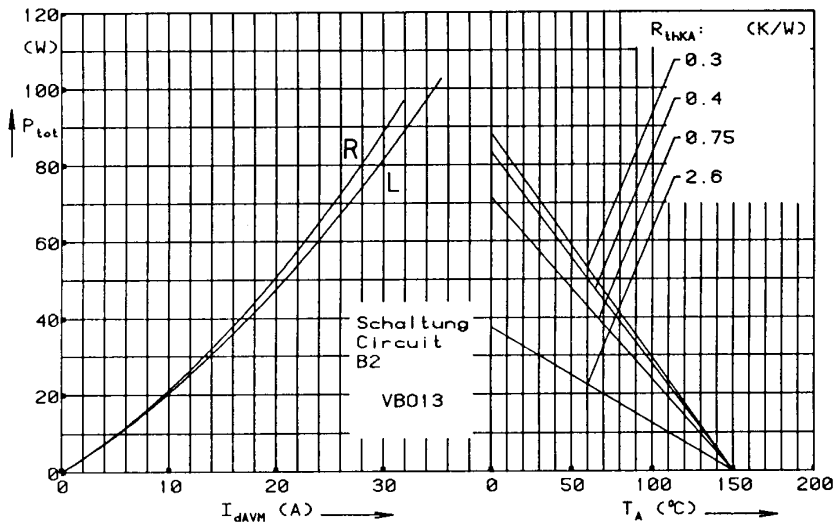

Fig. 4 Power dissipation versus direct output current and ambient temperature

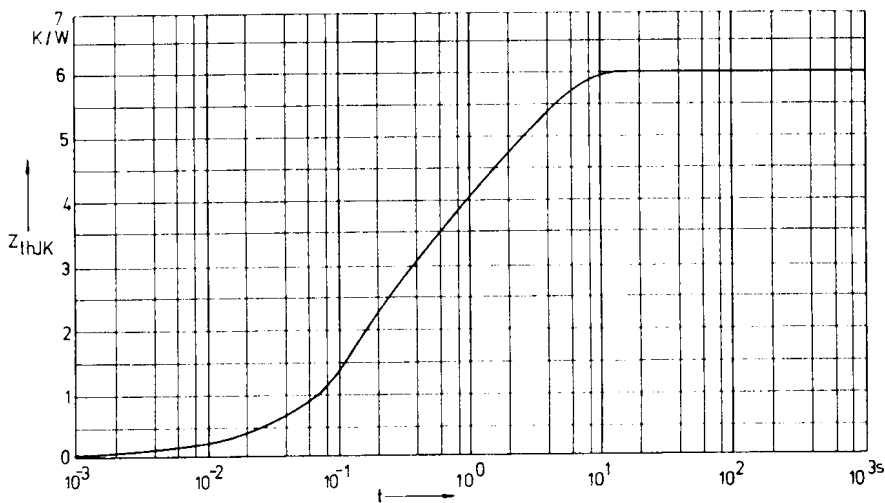

Fig. 5 Transient thermal impedance junction to heatsink per diode

Constants for  $Z_{\theta JK}$  calculation:

i	$R_{\theta i}$ (K/W)	$t_i$ (s)
1	0.059	0.00217
2	2.714	0.159
3	3.227	2.34

# Mouser Electronics

Authorized Distributor

Click to View Pricing, Inventory, Delivery & Lifecycle Information:

[IXYS:](#)

[VBO13-16AO2](#)