

FCI P/N	DIMENSION "L"	CABLE ASSY NAME	C-NUMBER
10111727-101LF	1000 mm + 10/-0 mm	CQSFP010	C112134.A1A
10111727-102LF	5000 mm + 50/-0 mm	CQSFP050	C112125.A1A
10111727-103LF	250 mm + 10/-0 mm	CQSFP25C	C112609.A1A
10111727-104LF	550 mm + 10/-0 mm	CQSFP55C	C112580.A1A

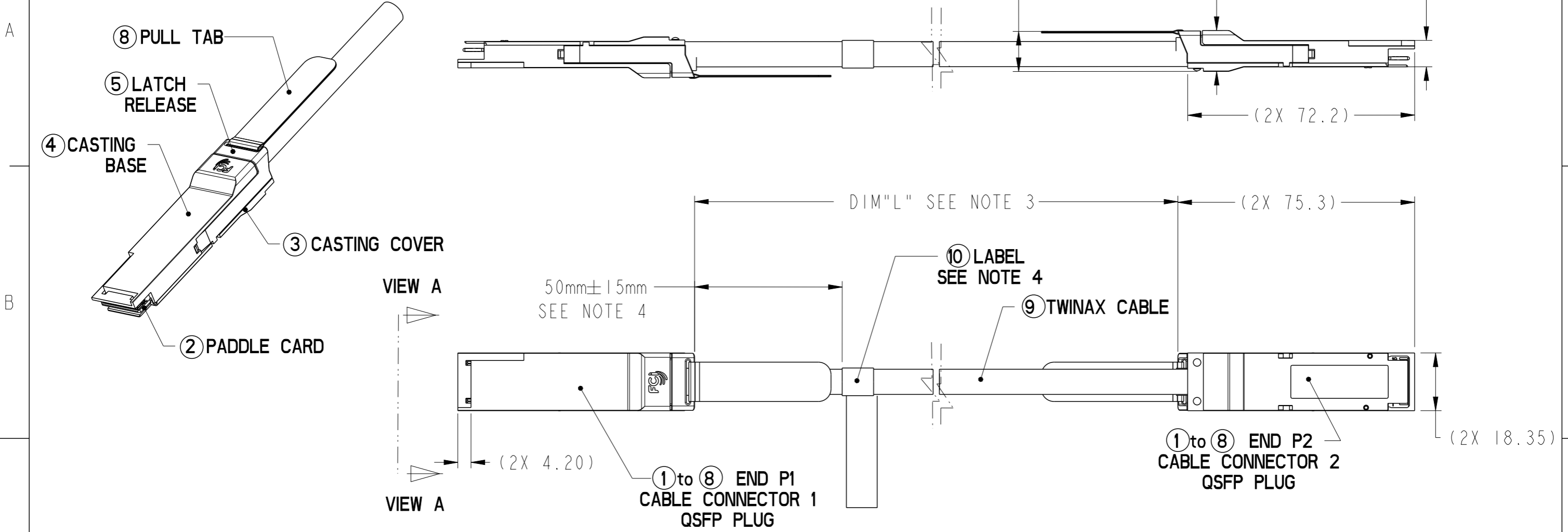

Copyright FCI.

dr	Deborah Ingram	2010/01/20	projection	mm	size	A3	scale	3:10
eng	Michael Zhou	2014/08/06			ecn no		ELX-N-18489-1	
chr	-	-			rel level		Released	
appr	Delhy Liu	2014/08/07	product family		QSFP PLUG			
			FINAL ASSEMBLY CUSTOM QSFP (PASSIVE) ASSEMBLY			dwg no 10111727		rev D
www.fci.com			cat. no.		-		Product - Customer Drw	
			sheet 1 of 3					

WIRING LIST (SEE NOTE 5)				
END P1		END P2		
POSITION	SYMBOL	POSITION	SYMBOL	
1	GND	20	GND	
2	PCIe_TX2-	21	PCIe_RX2-	
3	PCIe_TX2+	22	PCIe_RX2+	
4	GND	23	GND	
5	PCIe_TX4-	24	PCIe_RX4-	
6	PCIe_TX4+	25	PCIe_RX4+	
7	GND	26	GND	
8	RESERVED 5-	27	RESERVED 7-	
9	RESERVED 5+	28	RESERVED 7+	
10	GND	29	GND	
11	RESERVED 6-	30	RESERVED 8-	
12	RESERVED 6+	31	RESERVED 8+	
13	GND	32	GND	
14	PCIe_RX3+	33	PCIe_TX3+	
15	PCIe_RX3-	34	PCIe_TX3-	
16	GND	35	GND	
17	PCIe_RX1+	36	PCIe_TX1+	
18	PCIe_RX1-	37	PCIe_TX1-	
19	GND	38	GND	
20	GND	1	GND	
21	PCIe_RX2-	2	PCIe_TX2-	
22	PCIe_RX2+	3	PCIe_TX2+	
23	GND	4	GND	
24	PCIe_RX4-	5	PCIe_TX4-	
25	PCIe_RX4+	6	PCIe_TX4+	
26	GND	7	GND	
27	RESERVED 7-	8	RESERVED 5-	
28	RESERVED 7+	9	RESERVED 5+	
29	GND	10	GND	
30	RESERVED 8-	11	RESERVED 6-	
31	RESERVED 8+	12	RESERVED 6+	
32	GND	13	GND	
33	PCIe_TX3+	14	PCIe_RX3+	
34	PCIe_TX3-	15	PCIe_RX3-	
35	GND	16	GND	
36	PCIe_TX1+	17	PCIe_RX1+	
37	PCIe_TX1-	18	PCIe_RX1-	
38	GND	19	GND	

360° GROUNDING TO BACKSHELL SHIELD-----> 360° GROUNDING TO BACKSHELL SHIELD

FCI P/N 	DIMENSION "L"	CABLE ASSY NAME	C-NUMBER
10111727-101LF	1000 mm + 10/-0 mm	CQSFP010	C112134.AIA
10111727-102LF	5000 mm + 50/-0 mm	CQSFP050	C112125.AIA
10111727-103LF	250 mm + 10/-0 mm	CQSFP25C	C112609.AIA
10111727-104LF	550 mm + 10/-0 mm	CQSFP55C	C112580.AIA

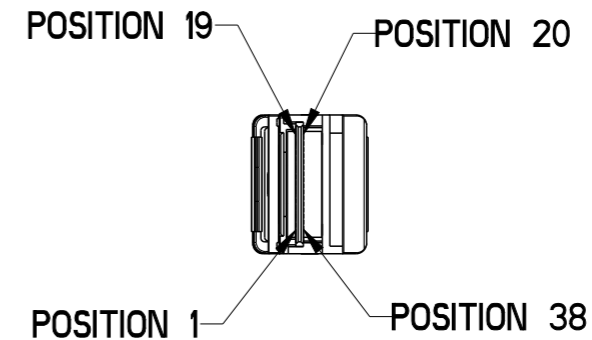

VIEW A
SCALE 2:1

*ALL GROUNDS ARE BUSSED TO GROUND PLANE OF PCB

dr	Deborah Ingram	2010/01/20	projection	mm	size	A3	scale	3:10
eng	Michael Zhou	2014/08/06			ecn no	ELX-N-18489-1		
chr	-	-	product family	QSFP PLUG	rel level	Released		
appr	Delhy Liu	2014/08/07						
		title		FINAL ASSEMBLY	dwg no	10111727	rev	D
www.fci.com		cat. no.	-	Product - Customer Drw	sheet 2 of 3			



Copyright FCI.

FCI P/N 	DIMENSION "L"	CABLE ASSY NAME	C-NUMBER
10111727-101LF	1000 mm + 10/-0 mm	CQSFP010	C112134.A1A
10111727-102LF	5000 mm + 50/-0 mm	CQSFP050	C112125.A1A
10111727-103LF	250 mm + 10/-0 mm	CQSFP25C	C112609.A1A
10111727-104LF	550 mm + 10/-0 mm	CQSFP55C	C112580.A1A

NOTES:

- MATERIAL:
 CASTINGS: ZINC ALLOY (ZAMAK) WITH Ni PLATING OVER Cu
 PULL TAB: THERMO PLASTIC POLYMER
 LATCH RELEASE: ZINC DIECAST (ZAMAK) WITH Ni PLATING OVER Cu
 DRIVE SCREWS: STAINLESS STEEL
 STRAIN RELIEF COLLAR: BRASS C26800
 SPRING: STAINLESS STEEL
 LOCTITE
 PADDLE CARD: FR4, PAD PLATING: Au OVER Ni
 CABLE IS TO BE UL RECGONIZED

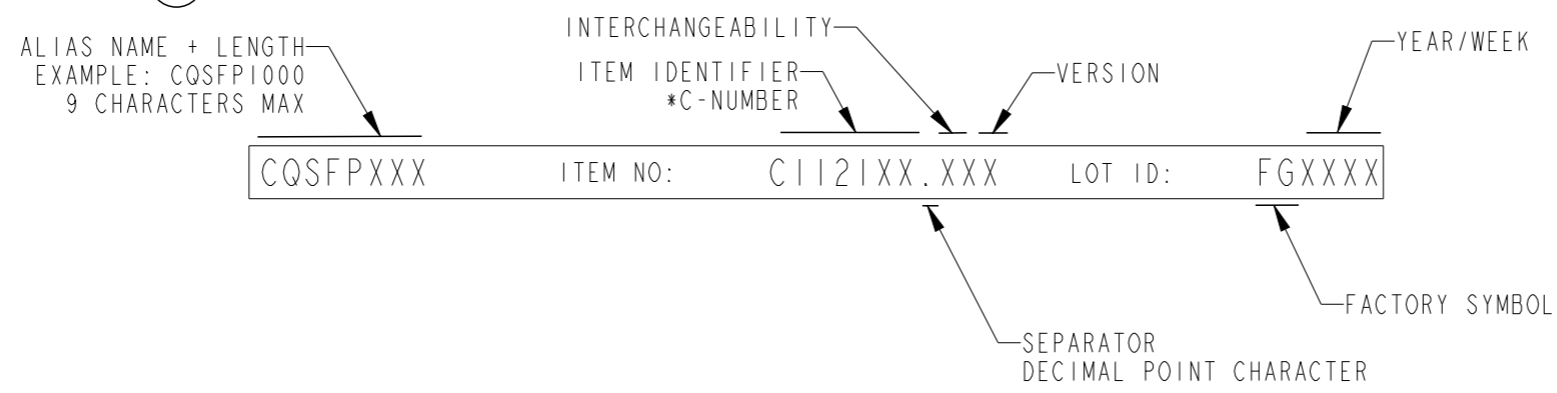

- THIS PRODUCT MEETS THE RESTRICTION OF HAZARDOUS SUBSTANCES IN ELECTRICAL AND ELECTRONIC EQUIPMENT (RoHS) DIRECTIVE (2002/95/EC)

- THIS DIMENSION IS A FINISHED PRODUCT LENGTH.
- UNLESS OTHERWISE SPECIFIED LABEL POSITION IS TO BE 50mm FROM BACKSIDE OF CONNECTOR.

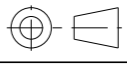
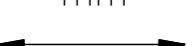

FONT SHALL BE CLEARLY VISIBLE AND BLACK IN COLOR.

- ALL CABLE ASSEMBLIES SHALL BE 100% TESTED FOR CONTINUITY AS DEFINED IN WIRING LIST.
- ALL CABLE ASSEMBLIES ARE TO BE 100% HI-POT TESTED.
- PACKAGING OF LEAD FREE PRODUCTS MEETS LABELING AND PACKAGING PER SPECIFICATION GS-14-920. PACKAGE CABLE ASSEMBLIES PER GS-14-1272. DUST COVERS ARE TO BE ASSEMBLED PRIOR TO PACKAING.
- A "  " SYMBOL WILL BE NEXT TO ANY DIMENSION, VIEW, OR NOTE WHICH HAS BEEN MODIFIED WITH THE CURRENT DRAWING REVISION. THE CURRENT REVISION WILL BE SHOWN IN THE SYMBOL.
- MIN. BEND RADIUS: REPEATED (20 BENDINGS) 7X ϕ , SINGLE 5X ϕ .
- THIS CABLE ASSEMBLY IS TO BE COMPLIANT WITH SFF-8436 MECHANICAL INTERFACE REQUIREMENTS (PIN OUT NOT PER SFF-8436).

dr	Deborah Ingram	2010/01/20	projection 	mm 	size	A3	scale	3:10	
eng	Michael Zhou	2014/08/06			ecn no	ELX-N-18489-1			
chr	-	-			rel level	Released			
appr	Delhy Liu	2014/08/07	product family	QSFP PLUG					
		FINAL ASSEMBLY CUSTOM QSFP (PASSIVE) ASSEMBLY			dwg no 10111727	rev D			
www.fci.com		cat. no.	-		Product - Customer Drw			sheet 3 of 3	

Copyright FCI.

Mouser Electronics

Authorized Distributor

Click to View Pricing, Inventory, Delivery & Lifecycle Information:

FCI:

[10111727-101LF](#)