

**UNCONTROLLED DOCUMENT**

NOTES:  
HOLE SIZE .156  
PANEL THICKNESS .062

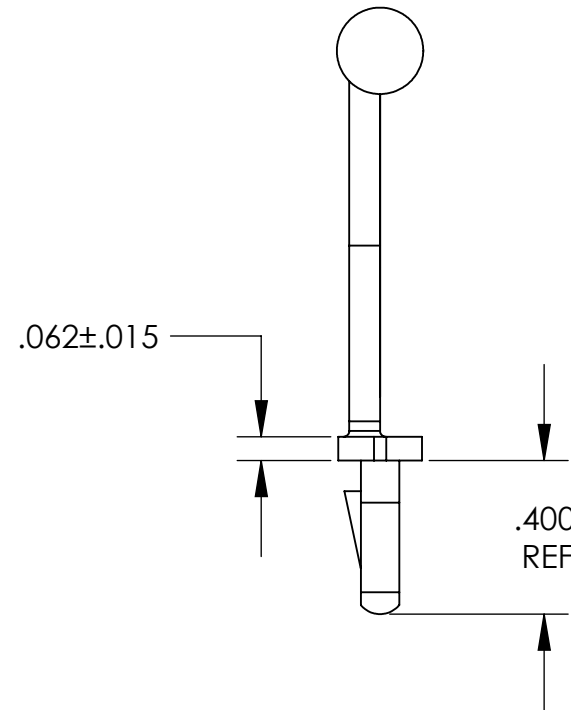
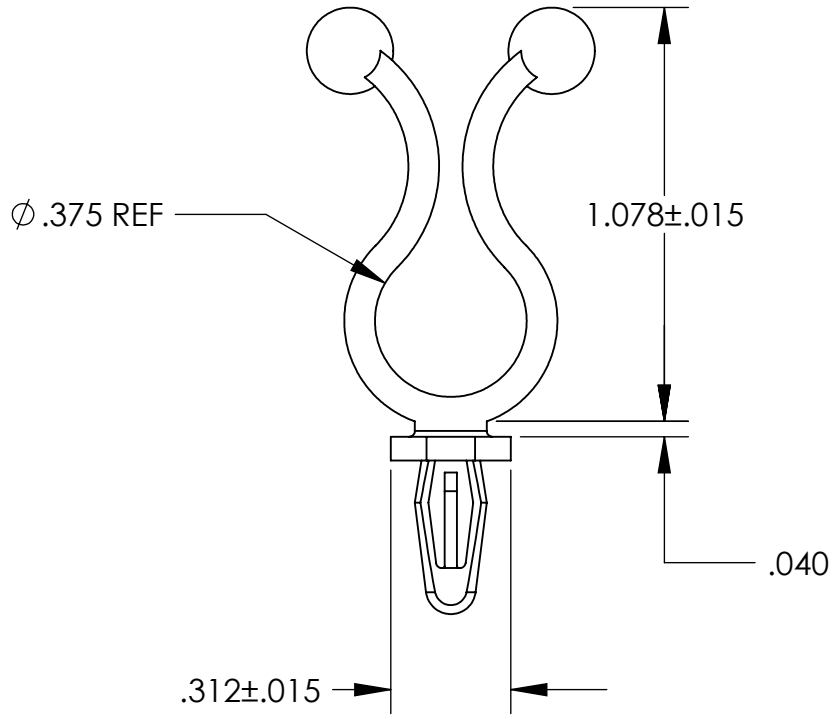

**TOLERANCES UNLESS NOTED**

- $\pm .005$  ON DIMENSIONS THRU  $.625$
- $\pm .008$  ON DIMENSIONS  $.626$  THRU  $1.000$
- $\pm .010$  ON DIMENSIONS  $1.001$  THRU  $1.500$
- $\pm .015$  ON DIMENSIONS LARGER THAN  $1.500$
- $\pm .015$  ON FRACTIONAL DIMENSIONS

**WE RESERVE THE RIGHT  
TO DISCONTINUE ITEMS,  
CHANGE SPECIFICATIONS  
OR DESIGN AT ANY TIME  
WITHOUT NOTICE AND  
WITHOUT INCURRING  
ANY OBLIGATIONS**

PROPERTY OF  
**MICRO PLASTICS INC.**

CATALOG DRAWING  
"EZ" TL SUPPORT 156 DIA HOLE  
MICRO P/N 23EZO375C0040  
DWG. # 23EZO375C0040  
FILE SERVER\ENG\WEB

MATERIAL: NYLON 6/6

DATE

SCALE  
2:1

**SD**

# Mouser Electronics

Authorized Distributor

Click to View Pricing, Inventory, Delivery & Lifecycle Information:

[Essentra:](#)

[23EZS0375C0040](#)