

UNCONTROLLED DOCUMENT

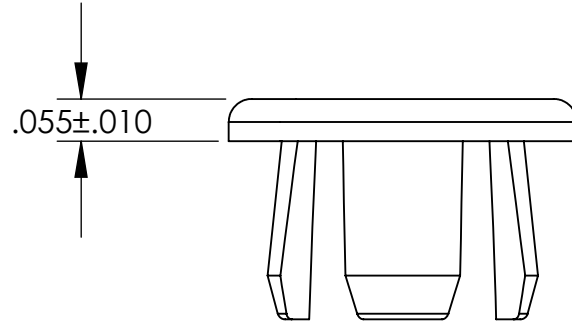

NOTES:
HOLE SIZE .312
PANEL THICKNESS .031/.140
HEAD STYLE BINDER
FINISH SMOOTH

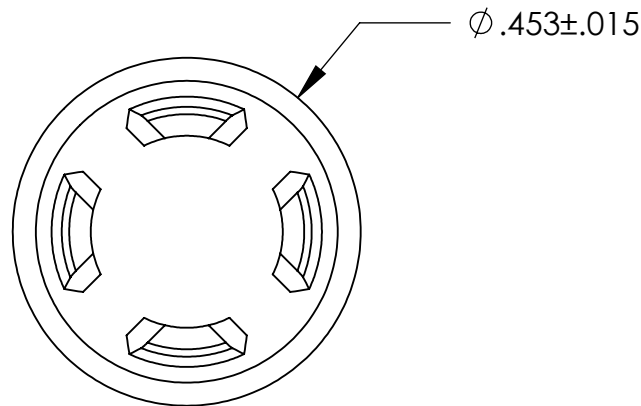

TOLERANCES UNLESS NOTED

- ±.005 ON DIMENSIONS THRU .625
- ±.008 ON DIMENSIONS .626 THRU 1.000
- ±.010 ON DIMENSIONS 1.001 THRU 1.500
- ±.015 ON DIMENSIONS LARGER THAN 1.500
- ±.015 ON FRACTIONAL DIMENSIONS

WE RESERVE THE RIGHT
TO DISCONTINUE ITEMS,
CHANGE SPECIFICATIONS
OR DESIGN AT ANY TIME
WITHOUT NOTICE AND
WITHOUT INCURRING
ANY OBLIGATIONS

PROPERTY OF		
MICRO PLASTICS INC.		
CATALOG DRAWING HOLE PLUG MICRO P/N 62PP031BG14 DWG. # 62PP031BG14 FILE SERVER\ENG\WEB		
MATERIAL:		6/6 NYLON
DATE	SCALE	DSB
	4:1	

Mouser Electronics

Authorized Distributor

Click to View Pricing, Inventory, Delivery & Lifecycle Information:

[Essentra:](#)

[62PP031BG14](#)