

Fuer diese Unterlage behalten wir uns alle Rechte vor, auch fuer den Fall der Patenterteilung oder Gebrauchsmustereintragung. Sie darf ohne unsere vorherige schriftliche Zustimmung weder vervielfaeltigt noch sonstwie benutzt, noch Dritten zuganglich gemacht werden.

Nur rot gestempelte oder auf Laufrarte gedruckte Dokumente unterliegen dem Nachrungsdienst und sind zur Fertigung freigegeben. Only red stamped or on jobcard printed documents are managed. These documents are approved for production.

All Rights reserved, including possible patents or trademarks. Documents shall not be provided to a third party or duplicated in any form without prior written permission.

CAD: Creo Parametric

1 2 3 4 5 6 7 8

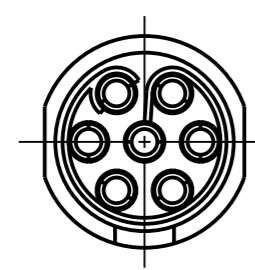

Nur Einsatz dargestellt!
view only insert!

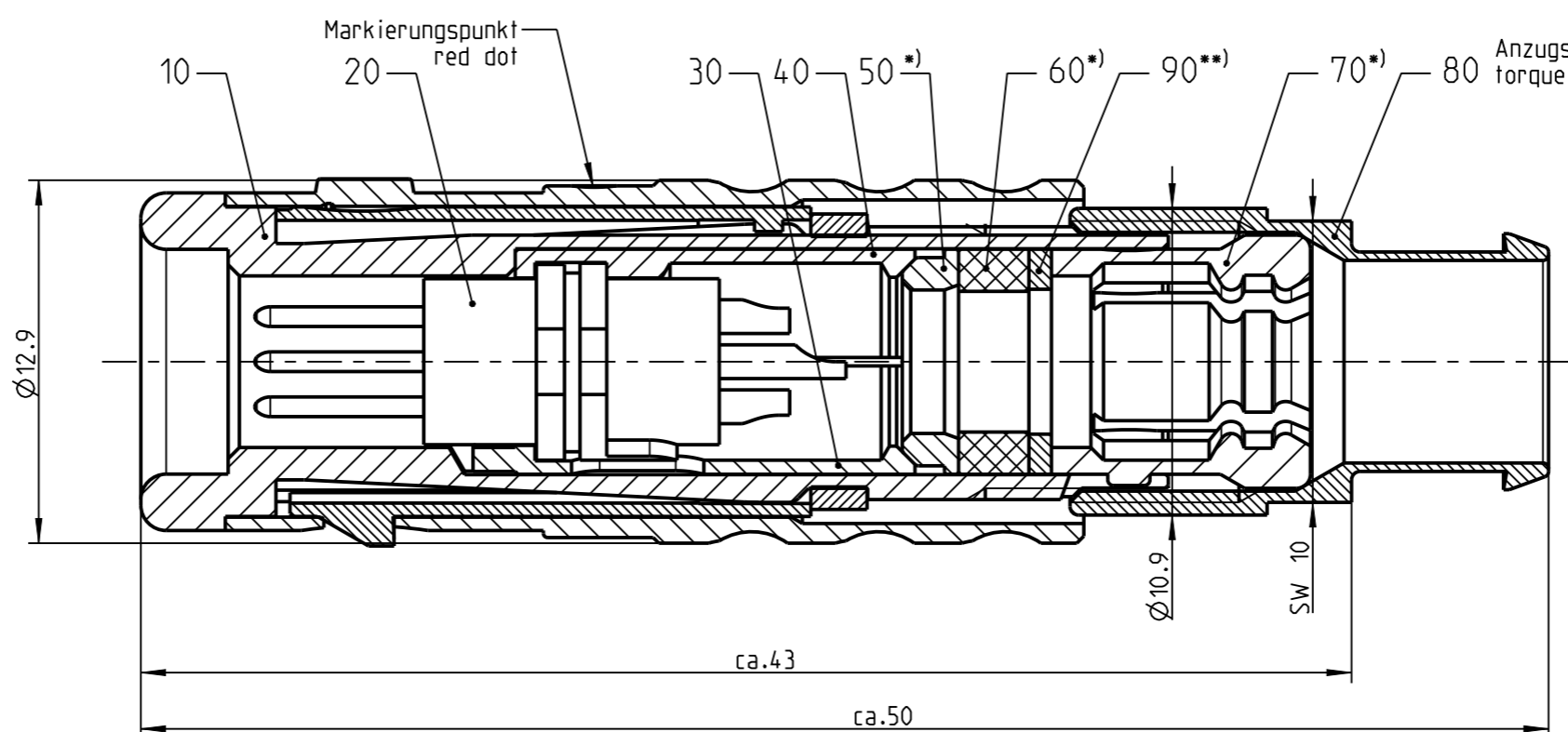

Anzugsdrehmoment: 1.0Nm
torque value

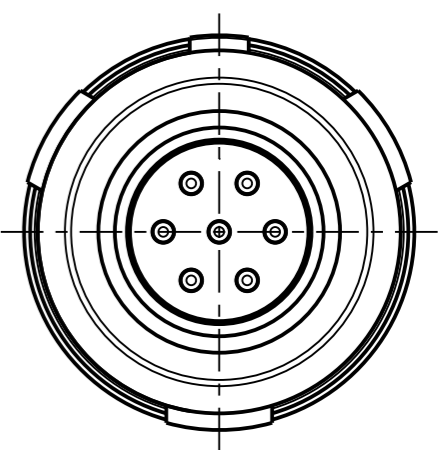

S21K0C - ---

(A) weitere Kodierungen in Richtung "A":
further codings in direction "A":
nur Gehaeuse dargestellt! / view only housing!
2:1

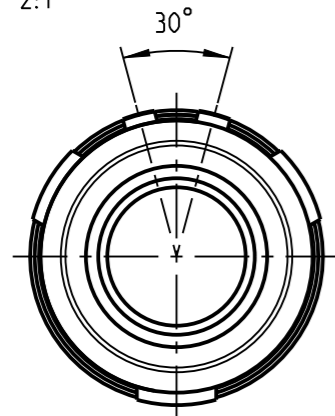

S21KAC - ---

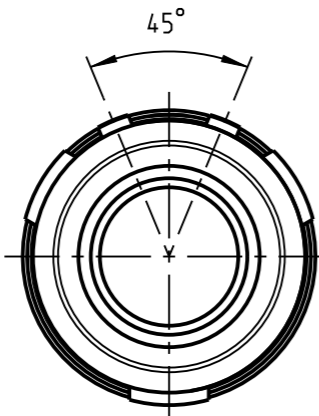

S21KCC - ---

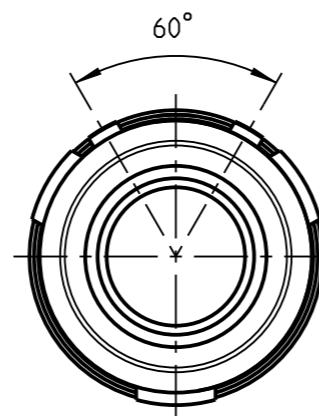

S21KFC - ---

empfohlene Abisolierlaenge
/recommended cable preparation

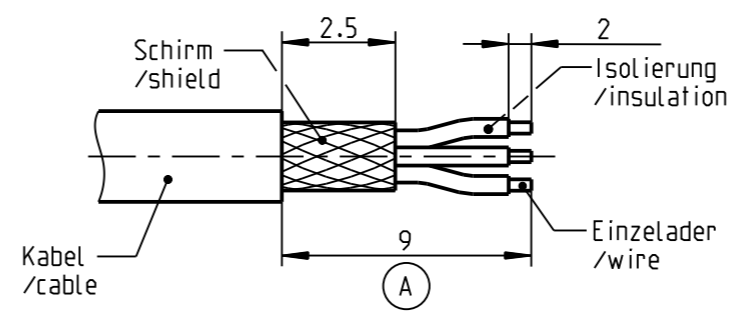

*) Darstellung nur Beispiel
figure on only for example

***) Scheibe nur bei Kabel-Ø ≤ 4.5mm
washer only at cable-Ø ≤ 4.5mm

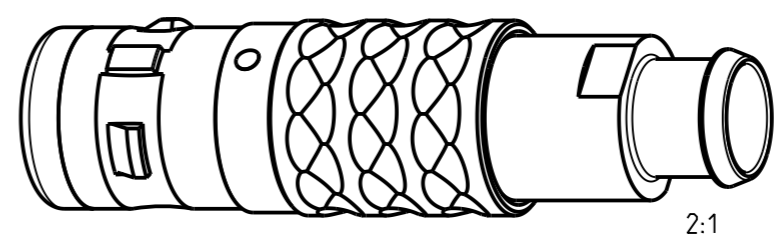

2:1

Technische Daten/Technical Data:

Werkstoffe/Materials: Gehaeuse/Housing:	Cu-Legierung /cu-alloy	KontaktØ/ContactØ:	Ø0.7 mm
Kontakte/Contacts:	Cu-Legierung /cu-alloy	Anschluß/Termination:	0.38mm ²
Isolierkoerper/Insulation Body:	PEEK	Loet/solder	AWG 22
Oberflaechen/Surfaces: Gehaeuse/Housing:	matt verchromt matt chrome-plated	Pruefspannung/Test Voltage:	(A) 1.0 kV AC (SAE AS 13441)
Kontakte/Contacts:	gal. Au	Strombelastung/Current Load:	(A) 7.5 A
Schutzart/Protection class: im gesteckten Zustand /plugged condition	IP 68	Einzelkontakte/single contacts:	

Knickschutzzuelle muss separat bestellt werden!
cable bend relief have to be ordered separately!
Bei den hier dargestellten ODU-Steckverbindern handelt es sich nach DIN EN 61984:2009 um Steckverbinder ohne Schaltleistung (COC) !
/the pictured ODU-connectors are in relation to DIN EN 61984:2009 connectors without switching capacity (COC) !

S21K_C-P07MFG0-700S	> 6.5 - 7.0 mm
S21K_C-P07MFG0-650S	> 6.0 - 6.5 mm
S21K_C-P07MFG0-600S	> 5.5 - 6.0 mm
S21K_C-P07MFG0-550S	> 5.0 - 5.5 mm
S21K_C-P07MFG0-500S	> 4.5 - 5.0 mm
S21K_C-P07MFG0-450S	> 4.0 - 4.5 mm
S21K_C-P07MFG0-400S	> 3.5 - 4.0 mm
S21K_C-P07MFG0-350S	> 3.0 - 3.5 mm
S21K_C-P07MFG0-300S	> 2.5 - 3.0 mm
S21K_C-P07MFG0-250S	> 2.0 - 2.5 mm
S21K_C-P07MFG0-200S	> 1.5 - 2.0 mm
S21K_C-P07MFG0-150S	> 1.0 - 1.5 mm
Oxaion-ID	KabelØ cableØ

		Benennung/description: Stecker cpl.	Werkstoff: material: see BOM
Allgmeintoleranz/general tol.: DIN ISO 2768-mH Tolerierung / Tolerancing: DIN ISO 8015		CAD-Nr.: design-ID: 00031949	Maßstab: scale: 4:1
Status/state: Approved	Version: revision: A	Teile-ID: part-ID:	Format: size: A3
Erstellt/prepared 10.10.2007 alengmueller	Geaendert/revised 10.05.2019 tschroedl	Oxaion-Nr.: S21K_C-P07MFG0-__OS	Einheit: dim.: mm
Freigabe/released 14.05.2019 rtrager	ODU-MUEHL DORF Datum/date	Ursprung/origin.: S21K0C-P07MFG0-...S	Bl.: sheet: 1

Mouser Electronics

Authorized Distributor

Click to View Pricing, Inventory, Delivery & Lifecycle Information:

[ODU USA:](#)

[S21KAC-P07MFG0-500S](#)