

Fuer diese Unterlage behalten wir uns alle Rechte vor, auch fuer den Fall der Patenterteilung oder Gebrauchsmustereintragung. Sie darf ohne unsere vorherige schriftliche Zustimmung weder vervielfaeltigt noch sonstwie benutzt, noch Dritten zuganglich gemacht werden.

Nur rol gestempelte oder auf Laufrarte gedruckte Dokumente unterliegen dem Nachungsdienst und sind zur Fertigung freigegeben. Only red stamped or on jobcard printed documents are managed. These documents are approved for production.

All Rights reserved, including possible patents or trademarks. Documents shall not be provided to a third party or duplicated in any form without prior written permission.

CAD: Creo Parametric

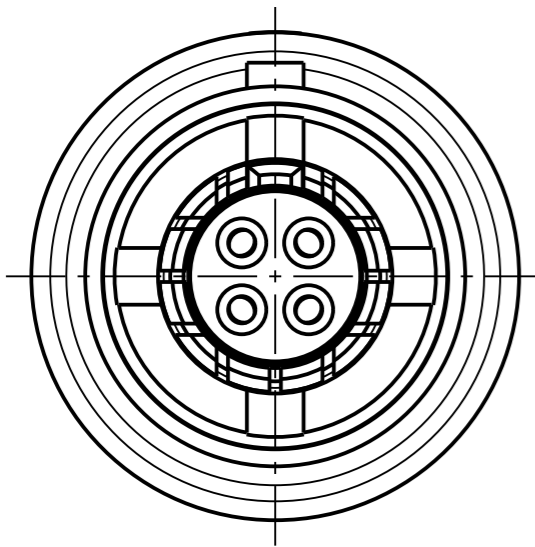

K10K0C - ----

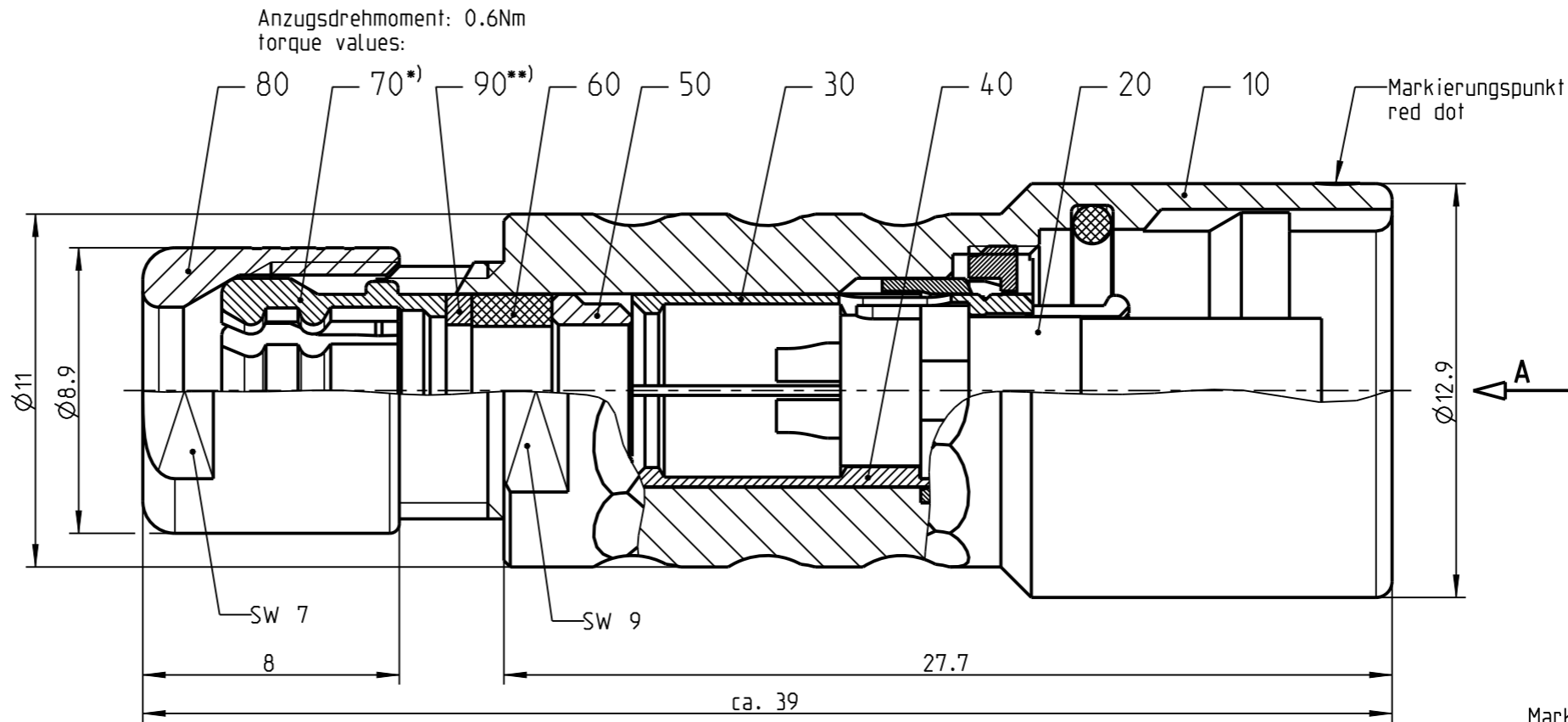

Weitere Kodierungen in Ansicht A:  
further codings in direction "A":  
3:1

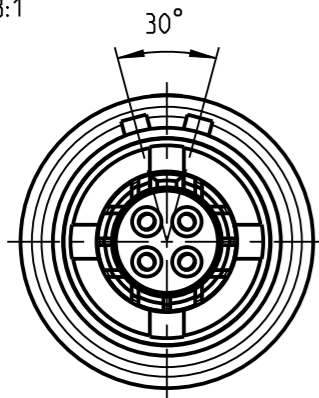

K10KAC - ----

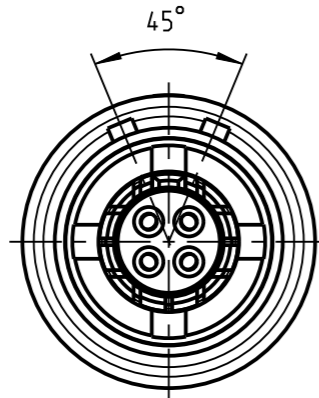

K10KCC - ----

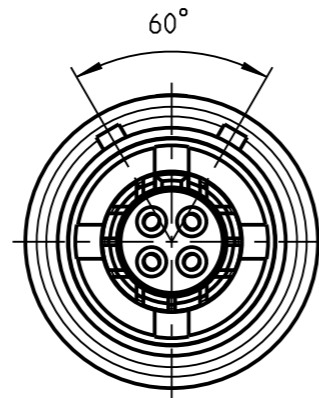

K10KFC - ----

empfohlene Abisolierlaenge  
/recommended cable preparation

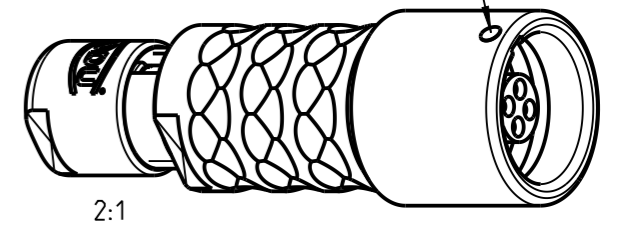
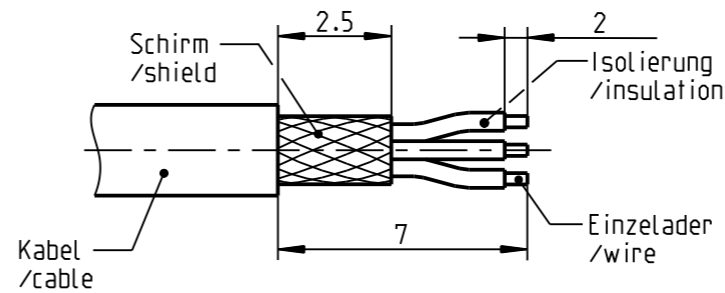

\*) Darstellung nur Beispiel  
figure on only for example

\*\*) Scheibe nur bei Kabel-Ø ≤ 3.5mm  
washer only at cable-Ø ≤ 3.5mm

Technische Daten/Technical Data:

Werkstoffe/Materials: Gehaeuse/Housing:	Cu-Legierung /cu-alloy
Kontakte/Contacts:	Cu-Legierung /cu-alloy
Isolierkoerper/Insulation Body:	PEEK
Oberflaechen/Surfaces: Gehaeuse/Housing:	matt verchromt matt chrome-plated
Kontakte/Contacts:	gal. Au
Schutzart/Protection class: im gesteckten Zustand /plugged condition	IP 68

KontaktØ/ContactØ:	Ø0.7 mm
Anschluß/Termination:	0.38mm <sup>2</sup> AWG 22
Loet/solder	
Pruefspannung/Test Voltage:	0.9 kV AC (SAE AS 13441)
Strombelastung/Current Load: Einzelkontakte/single contacts:	7.5 A

Bei den hier dargestellten ODU-Steckverbindern handelt es sich nach DIN EN 61984:2009 um Steckverbinder ohne Schaltleistung (COC) !  
/the pictured ODU-connectors are in relation to DIN EN 61984:2009 connectors without switching capacity (COC) !

K10K_C-P04LFG0-5000	> 4.5 - 5.0 mm
K10K_C-P04LFG0-4500	> 4.0 - 4.5 mm
K10K_C-P04LFG0-4000	> 3.5 - 4.0 mm
K10K_C-P04LFG0-3500	> 3.0 - 3.5 mm
K10K_C-P04LFG0-3000	> 2.5 - 3.0 mm
K10K_C-P04LFG0-2500	> 2.0 - 2.5 mm
K10K_C-P04LFG0-2000	> 1.5 - 2.0 mm
Oxaion-ID	KabelØ cableØ

		Benennung/description: Kabelteil cpl.	Werkstoff: material: see BOM
Allgmeintoleranz/general tol.: DIN ISO 2768-mH Tolerierung / Tolerancing: DIN ISO 8015		CAD-Nr.: design-ID: <b>00158386</b>	Maßstab: scale: <b>5:1</b>
Status/state: <b>Approved</b>	Version: revision: -	Teile-ID: part-ID:	Format: size: <b>A3</b>
Erstellt/prepared 06.03.2019 tschroedl	Freigebe/released 07.03.2019 rtrager	Oxaion-Nr.: <b>K10K_C-P04LFG0-__00</b>	Einheit: dim.: mm
ODU-MUEHL DORF	Datum/date	Ursprung/origin.:	Bl.: sheet: 1

# Mouser Electronics

Authorized Distributor

Click to View Pricing, Inventory, Delivery & Lifecycle Information:

[ODU USA:](#)

[K10KAC-P04LFG0-4000](#)