

Cree® PLCC6 3 in 1 SMD LED SLV6D-FKB



PRODUCT DESCRIPTION

These SMD LEDs are packaged in an industry standard PLCC6 package.

These high performance tricolor SMT LEDs are designed to work in a wide range of applications. A wide viewing angle and high brightness make these LEDs suitable for various full color applications.

The encapsulation resin contains UV inhibitors to minimize the effects of long-term exposure to direct sunlight, resulting in stable light output over the life of the LED.

FEATURES

- Size (mm): 5.5 x 5.5
- Dominant Wavelength:
Red (619 - 624nm)
Green (520 - 540nm)
Blue (460 - 480nm)
- Luminous Intensity (mcd)
Red (560 - 1120)
Green (900 - 1800)
Blue (180 - 450)
- Moisture Sensitivity Level: 5a
- Lead-Free
- RoHS Compliant
- Matte Surface

APPLICATIONS

- Decorative lighting
- Amusement

*: This part is tested under the condition of assembling it on a PCB with isolating the electrical path by silicone. The leads area of the LED is not IPx8 rated and it's required to insulate for moisture by customer in outdoor application.

ABSOLUTE MAXIMUM RATINGS ($T_A = 25^\circ\text{C}$)

Items	Symbol	Absolute Maximum Rating			Unit
		R	G	B	
Forward Current ^{Note 1}	I_F	50	35	35	mA
Peak Forward Current ^{Note 2}	I_{FP}	200	100	100	mA
Reverse Voltage	V_R	5	5	5	V
Power Dissipation	P_D	125	126	133	mW
Operation Temperature	T_{opr}	-40 ~ +100			$^\circ\text{C}$
Storage Temperature	T_{stg}	-40 ~ +100			$^\circ\text{C}$
Junction Temperature	T_J	110	110	110	$^\circ\text{C}$
Junction/ambient 1 chip on	R_{THJA}	450	400	450	$^\circ\text{C/W}$
Junction/ambient 3 chips on	R_{THJA}	650	580	680	$^\circ\text{C/W}$
Junction/solder point 1 chip on	R_{THJS}	230	230	200	$^\circ\text{C/W}$
Junction/solder point 3 chips on	R_{THJS}	230	230	200	$^\circ\text{C/W}$
Electrostatic Discharge Classification(MIL-STD-883E)	ESD	1000 V			

Note: 1.Single-color light.
2.Pulse width ≤ 0.1 msec, duty $\leq 1/10$.

TYPICAL ELECTRICAL & OPTICAL CHARACTERISTICS ($T_A = 25^\circ\text{C}$)

Characteristics	Condition	Symbol	Values			Unit
			R	G	B	
Dominant Wavelength	$I_F = 15$ mA(R) $I_F = 10$ mA(G) $I_F = 10$ mA(B)	λ_{DOM}	619~624	520~540	460~480	nm
Spectral bandwidth at 50% I_{REL} max	$I_F = 15$ mA(R) $I_F = 10$ mA(G) $I_F = 10$ mA(B)	$\Delta \lambda$	24	38	28	nm
Forward Voltage	$I_F = 15$ mA(R) $I_F = 10$ mA(G) $I_F = 10$ mA(B)	$V_{F(avg)}$	2.0	2.8	3.0	V
		$V_{F(max)}$	2.5	3.6	3.8	V
Luminous Intensity	$I_F = 15$ mA(R) $I_F = 10$ mA(G) $I_F = 10$ mA(B)	$I_{V(min)}$	560	900	180	mcd
		$I_{V(avg)}$	780	1200	280	mcd
Reverse Current (max)	$V_R = 5$ V	I_R	10	10	10	μA

Note: Continuous reverse voltage can cause LED damage.

INTENSITY BIN LIMIT (RED $I_f = 15$ mA, GREEN $I_f = 10$ mA, BLUE $I_f = 10$ mA)

Red

Bin Code	Min.(mcd)	Max.(mcd)
K	560	710
np	635	805
M	710	900
qr	805	1010
N	900	1120

Green

Bin Code	Min.(mcd)	Max.(mcd)
N	900	1120
st	1010	1260
P	1120	1400
vw	1260	1600
Q	1400	1800

Blue

Bin Code	Min.(mcd)	Max.(mcd)
E	180	224
bc	202	252
F	224	280
de	252	318
G	280	355
fg	318	403
H	355	450

Tolerance of measurement of luminous intensity is $\pm 10\%$.

COLOR BIN LIMIT (RED $I_f = 15$ mA, GREEN $I_f = 10$ mA, BLUE $I_f = 10$ mA)

Red

Bin Code	Min.(nm)	Max.(nm)
RB	619	624

Green

Bin Code	Min.(nm)	Max.(nm)
G7	520	525
G23	522.5	527.5
G8	525	530
G45	527.5	532.5
G9	530	535
G67	532.5	537.5
Ga	535	540

Blue

Bin Code	Min.(nm)	Max.(nm)
B3	460	465
B23	462.5	467.5
B4	465	470
B45	467.5	472.5
B5	470	475
B67	472.5	477.5
B6	475	480

Tolerance of measurement of dominant wavelength is ± 1 nm.

ORDER CODE TABLE*

Kit Number	Color	Luminous Intensity (mcd)		Dominant Wavelength (nm)				Pack- age
		Min.	Max.	Color Bin	Min. (nm)	Color Bin	Max. (nm)	
SLV6D-FKB-CKNNQEHHB7a363	Red	560	1120	RB	619	RB	624	Reel
	Green	900	1800	G7	520	Ga	540	Reel
	Blue	180	450	B3	460	B6	480	Reel
SLV6D-FKB-CK1N1E1BB7D3D3	Red	Any 1 Intensity bin from K(560) - N(1120)		RB	619	RB	624	Reel
	Green	Any 1 Intensity bin from N(900) - Q(1800)		Any 1 hue bin from G7(520) - Ga(540)				Reel
	Blue	Any 1 Intensity bin from E(180) - H(450)		Any 1 hue bin from B3(460) - B6(480)				Reel
SLV6D-FKB-CM1P1F1BB7D3D3	Red	Any 1 Intensity bin from M(710) - N(1120)		RB	619	RB	624	Reel
	Green	Any 1 Intensity bin from P(1120) - Q(1800)		Any 1 hue bin from G7(520) - Ga(540)				Reel
	Blue	Any 1 Intensity bin from F(224) - H(450)		Any 1 hue bin from B3(460) - B6(480)				Reel

Notes:

1. The above kit numbers represent the order codes which include multiple intensity-bin and color-bin codes. Only one intensity-bin code and one color-bin code will be shipped on each reel. Single intensity-bin code and single color-bin code will be orderable in certain quantities.
2. For example, any 1 intensity-bin from K - N means only 1 intensity-bin (K or np or M or qr or N) will be shipped by Cree.
3. For example, any 1 color-bin from G7 - Ga means only 1 color-bin (G7 or G23 or G8 or G45 or G9 or G67 or Ga) will be shipped by Cree.
4. Please refer to the "Cree LED Lamp Reliability Test Standards" document ^{#1} for reliability test conditions.
5. Please refer to the "Cree LED Lamp Soldering & Handling" document ^{#2} for information about how to use this LED product safely.

#1: Refer to http://www.cree.com/led-components/media/documents/LED_Lamp_Reliability_Test_Standard.pdf

#2: Refer to <http://www.cree.com/led-components/media/documents/sh-HB.pdf>

GRAPHS

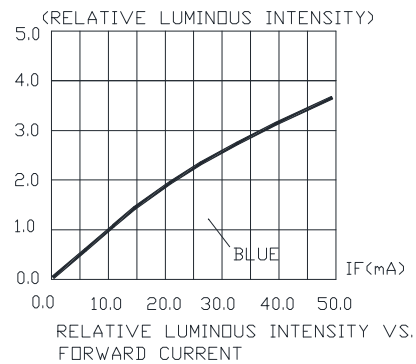
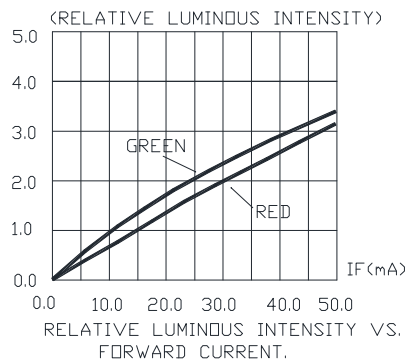
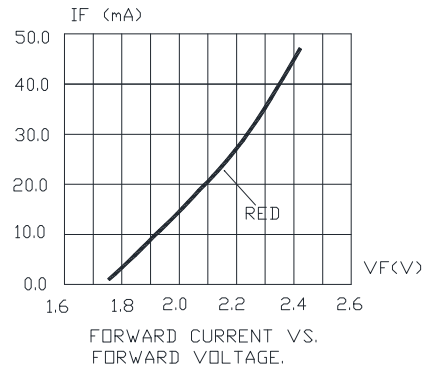
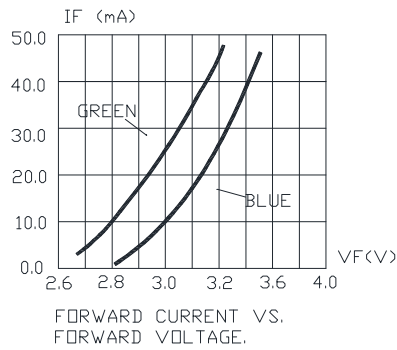
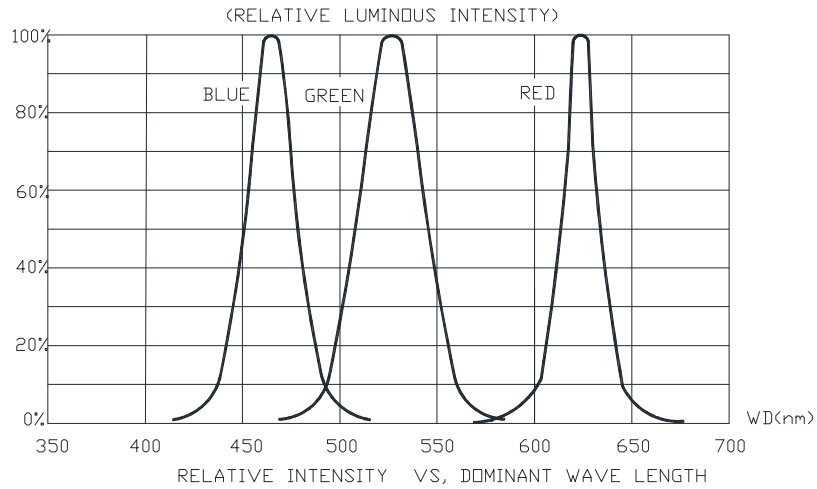

The above data are collected from statistical figures that do not necessarily correspond to the actual parameters of each single LED. Hence, these data will be changed without further notice.

GRAPHS

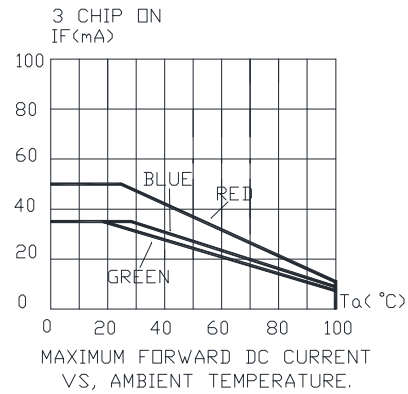
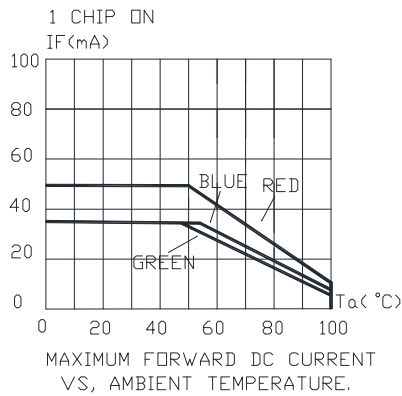
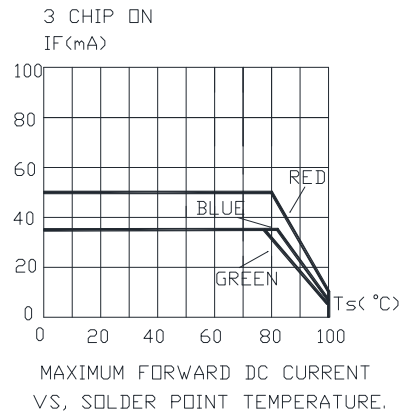
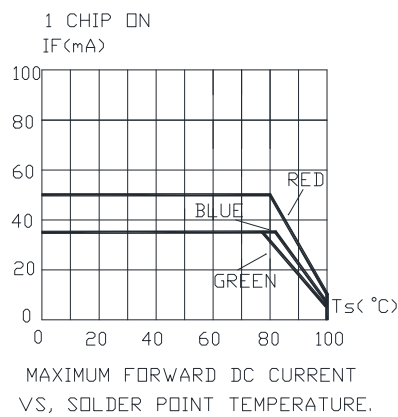
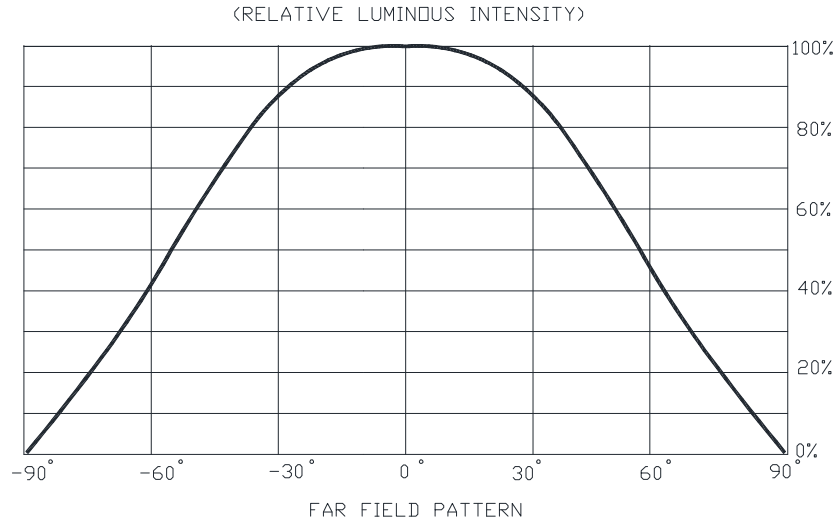

The above data are collected from statistical figures that do not necessarily correspond to the actual parameters of each single LED. Hence, these data will be changed without further notice.

MECHANICAL DIMENSIONS

All dimensions are in mm.

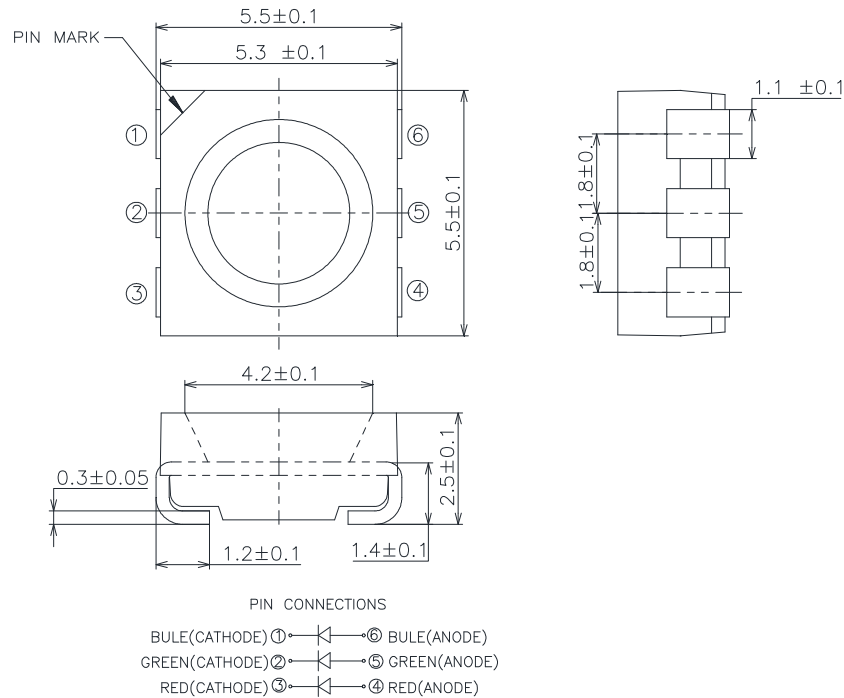

NOTES

RoHS Compliance

The levels of RoHS-restricted materials in this product are below the maximum concentration values (also referred to as the threshold limits) permitted for such substances, or are used in an exempted application in accordance with EU Directive 2011/65/EC (RoHS2), as implemented by EU member states on January 2, 2013 and amended on March 31, 2015 by EU Directive 2015/863/EU.

RoHS Declarations for this product can be obtained from your Cree representative or from the Product Ecology section of the Cree website.

Vision Advisory Claim

Users should be cautioned not to stare at the light of this LED product. The bright light can damage the eye.

KIT NUMBER SYSTEM

Cree LED lamps are tested and sorted into performance bins. A bin is specified by ranges of color, forward voltage, and brightness. Sorted LEDs are packaged for shipping in various convenient options. Please refer to the "Cree LED Lamp Packaging Standard" document for more information about shipping and packaging options.

Cree LEDs are sold by order codes in combinations of bins called kits. Order codes are configured in the following manner:



RELIABILITY

Tests and Results

Test	Applicable Standards	Test Condition	Note	Number of Damaged
Temperature Cycle	JEITA ED-4701 100 105	-40°C~25°C~100°C~25°C 30 mins, 5 mins, 30 mins, 5 mins	100 cycles	0/45
Thermal Shock	MIL-STD-202G	-40°C~100°C 30 mins, 30 mins	100 cycles	0/45
Moisture Resistance	JEITA ED-4701 200 203	25°C~65°C~ 90%RH 24hrs/1cycle	10 cycles	0/45
High Temperature Storage	JEITA ED-4701 200 201	T _A =100°C	500 hrs	0/45
Temperature Humidity Storage	JEITA ED-4701 100 103	T _A =60°C RH=90%	500 hrs	0/45
Low Temperature Storage	JEITA ED-4701 200 202	T _A =-40°C	500 hrs	0/45
High Temperature Life Test	-	T _A =85°C I _F =15 mA	1000 hrs	0/45
Life Test	-	T _A =25°C IF: R=30mA G=35mA B=20mA	1000 hrs	0/45
High Humidity Heat Life Test	-	60°C RH=90% I _F =15 mA	500 hrs	0/45
Low Temperature Life Test	-	T _A =-40°C IF: R=30mA G=35mA B=20mA	500 hrs	0/45
Resistance to Soldering Heat(Reflow Soldering)	JEITA ED-4701 300 301	T _{sol} =250°C,10sec (Pre treatment 30°C,70%,168hrs)	2 times	0/45
Vibration-variable Frequency	MIL-STE-883 Method 2007	20G min, 20 to 2000Hz, 4cycles, 4mins, Each x,y,z	/	0/45
Electrostatic Discharge Test	AEC(Q101-001)	Human body model 1000 V (Forward and reverse current conduct electricity each 1time)	/	0/45

Failure Criteria

Item	Symbol	Test Condition	Criteria for Judgment	
			Min.	Max.
Forward Voltage	V _F	I _F = 20 mA	-	Initial Data x 1.1
Reverse Current	I _R	V _R = 5 V	-	10 μA
Luminous Flux/Intensity	Φ _V	I _F = 20 mA	Initial Data x 0.7	-
Resistance to Soldering Heat	-	I _F = 20 mA	No dead lamps and visual damage	
Vibration-variable Frequency	-	I _F = 20 mA	No dead lamps and visual damage	

REFLOW SOLDERING

- The SLV6D-FKB is rated as a MSL 5a product.
- The recommended floor life out of bag is 24hrs.
- The temperature profile is as below:

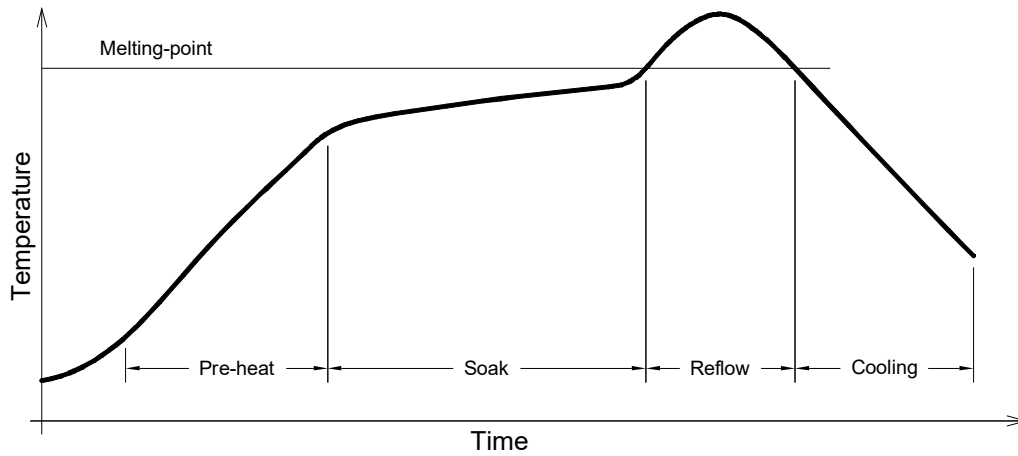

Use only with SLV6D-FKB

Solder
Average ramp-up rate = 4°C/s max
Preheat temperature = 150°C ~200°C
Preheat time = 120s max
Ramp-down rate = 6°C/s max
Peak temperature = 250°C max
Time within 5°C of actual Peak Temperature = 10s max
Duration above 217°C is 60s max

Soldering pad:

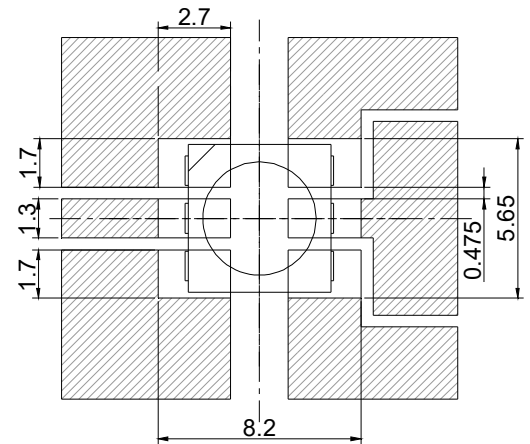

Refer to "<http://www.cree.com/led-components/media/documents/sh-HB.pdf>" for soldering & handling details.

NOTES

- The packaging sizes of these SMD products are very small and the resin is still soft after solidification. Users are required to handle with care. Never touch the resin surface of SMD products.
- To avoid damaging the product's surface and interior device, it is recommended to choose a special nozzle to pick up the SMD products during the process of SMT production. If handling is necessary, take special care when picking up these products. The following method is necessary:

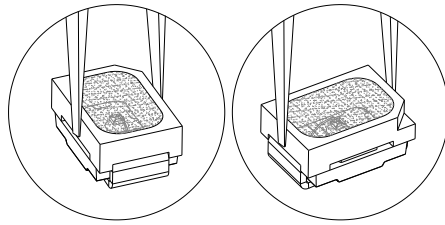

PACKAGING

- The boxes are not water resistant and they must be kept away from water and moisture.
- The LEDs are packed in cardboard boxes after packaging in normal or anti-electrostatic bags.
- Cardboard boxes will be used to protect the LEDs from mechanical shocks during transportation.
- The reel pack is applied in SMD LED.
- Max 3000 pcs per reel.

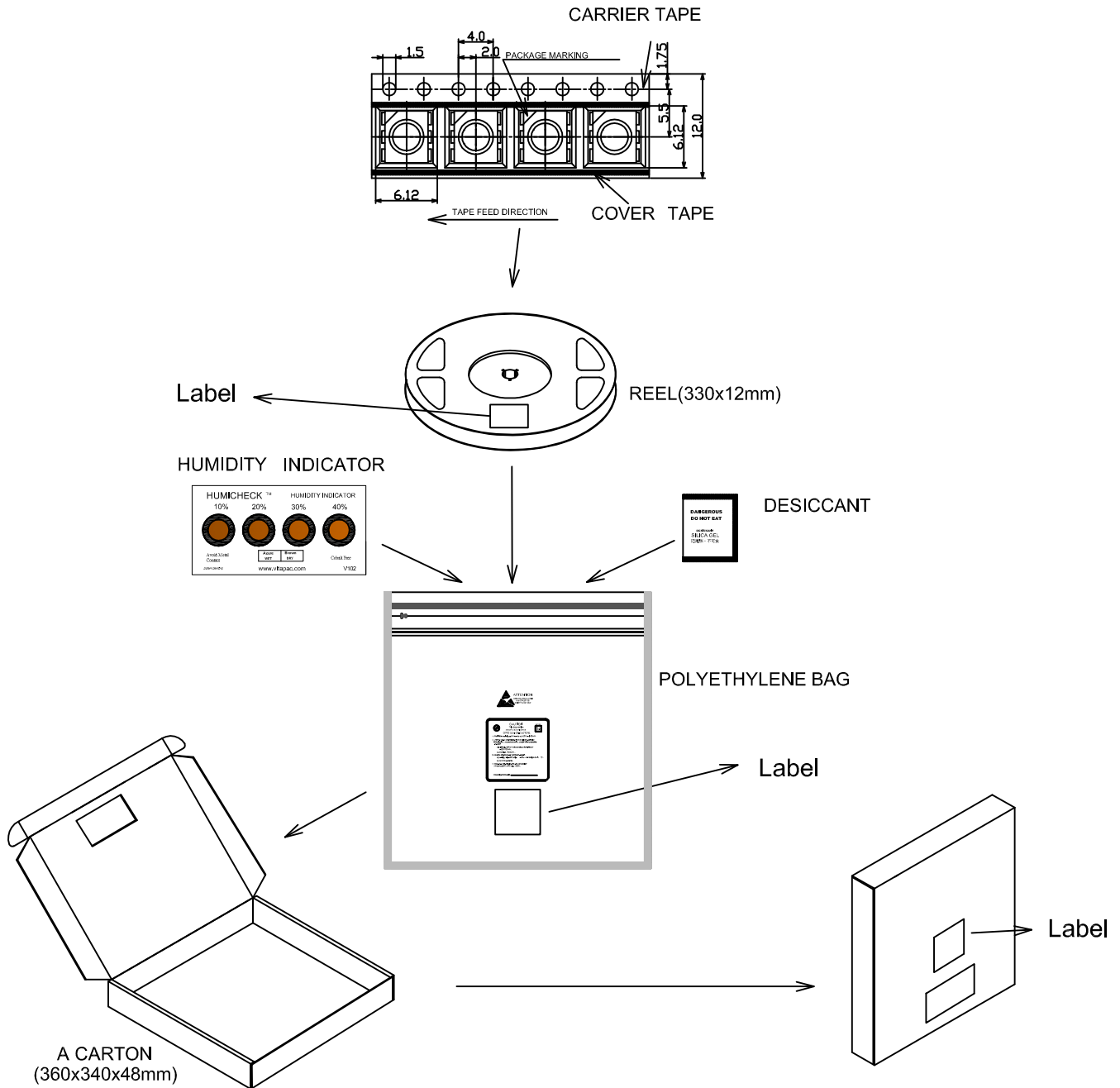

Mouser Electronics

Authorized Distributor

Click to View Pricing, Inventory, Delivery & Lifecycle Information:

[Cree, Inc.:](#)

[SLV6D-FKB-CK1N1E1BB7D3D3](#) [SLV6D-FKB-CKNNQEHHB7a363](#) [SLV6D-FKB-CM1P1F1BB7D3D3](#)