

**Contact assignment:**

- 1) black
- 2) blue
- PE) green-yellow
- 4) brown
- 5) white

**Technical specification:**

Rated voltage: 300 V  
IEC 60664-1

Overvoltage category: 2  
IEC 60664-1

Overvoltage: 2,7 kV  
IEC 60664-1

Current rating: 0,75mm<sup>2</sup> 1,5mm<sup>2</sup>  
IEC 60512-3 at 40°C 8 A 10 A

Insulation resistance: >=100 MΩ  
IEC 60512

Pollution degree: 3/2  
IEC 60664-1

Degree of protection: IP 68, in mated condition  
IEC 60529

Temperature range: -30°C ... +80°C  
IEC 60664-1

Mating cycles: >=100  
IEC 60512-9a

Termination: crimped

**Materials:**

Contact: CuZn

Contact plating: Nickel, gold plated

Contact carrier: TPU, UL 94

Coupling nut/screw: CuZn, nickel plated

Moulding body: TPU, UL 94, grey

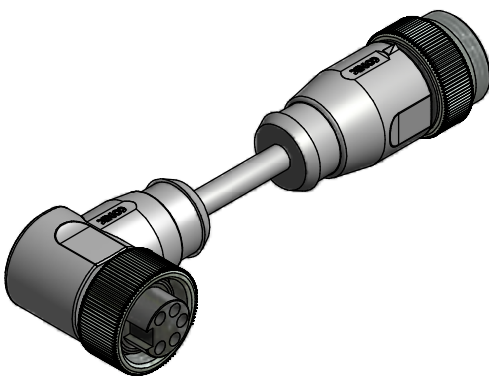

Part no:	Description:	Length L:	Cable:
41-01233	SAL - 7/8 - RKW4PE - RS4PE - 0,6 / A3	0,6m	PVC, UL 2464, grey, 5x0,75mm <sup>2</sup> Cable: 781-A37500
41-01234	SAL - 7/8 - RKW4PE - RS4PE - 1 / A3	1m	
41-01235	SAL - 7/8 - RKW4PE - RS4PE - 1,5 / A3	1,5m	
41-01236	SAL - 7/8 - RKW4PE - RS4PE - 2 / A3	2m	
41-xxxxx	SAL - 7/8 - RKW4PE - RS4PE - ... / A3	x	
41-01281	SAL - 7/8 - RKW4PE - RS4PE - 0,6 / A3 / 150	0,6m	PVC, UL 2464, grey, 5x1,50mm <sup>2</sup> Cable: 781-A38500
41-01282	SAL - 7/8 - RKW4PE - RS4PE - 1 / A3 / 150	1m	
41-01283	SAL - 7/8 - RKW4PE - RS4PE - 1,5 / A3 / 150	1,5m	
41-01284	SAL - 7/8 - RKW4PE - RS4PE - 2 / A3 / 150	2m	
41-xxxxx	SAL - 7/8 - RKW4PE - RS4PE - ... / A3 / 150	x	

D see data sheet cable

DO NOT ALTER CAD DRAWING BY HAND	Directive 2002/95/EC RoHS compliant	Index: b 13.10.10 KH Ä3736 technical specification changed, part no. cable in table added, neutral line added	dim. in mm	title: <b>Connecting cable 7/8", female connector angled - male connector axial</b>						
		tolerance of cable: L ≤ 4m: L + 40mm L > 4m: L + 1%			<table border="1"> <tr> <td>date</td> <td>name</td> </tr> <tr> <td>12.02.08</td> <td>Franz</td> </tr> <tr> <td>12.02.08</td> <td>Mankopf</td> </tr> </table>	date	name	12.02.08	Franz	12.02.08
		date	name							
		12.02.08	Franz							
12.02.08	Mankopf									
THIS DRAWING MAY NOT BE COPIED OR REPRODUCED IN ANY WAY, AND MAY NOT BE PASSED ON TO A THIRD PARTY WITHOUT WRITTEN PERMISSION. OWNERSHIP AND COPYRIGHT OF CONEC GmbH		dwg no:	41K1A365							
		part no:	see table							

# Mouser Electronics

Authorized Distributor

Click to View Pricing, Inventory, Delivery & Lifecycle Information:

[CONEC:](#)

[41-01284](#)