

CDBT-54/S/C/A-HF

Reverse Voltage: 30 Volts
Forward Current: 200 mA
RoHS Device
Halogen free

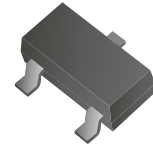

Features

- Design for mounting on small surface.
- High speed switching application, circuit protection.
- Low forward voltage drop.

Mechanical data

- Case: SOT-23, molded plastic.
- Terminals: Solderable per MIL-STD-750, method 2026.
- Weight: 0.0078 grams(approx.).

Circuit diagram

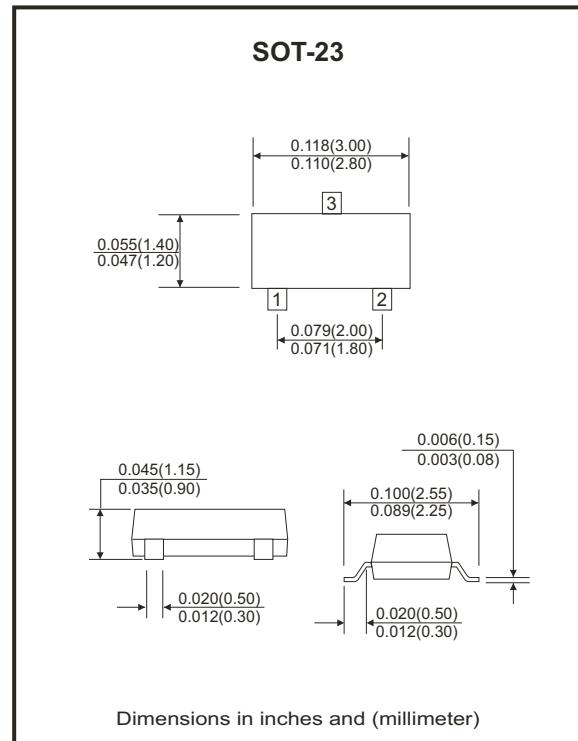
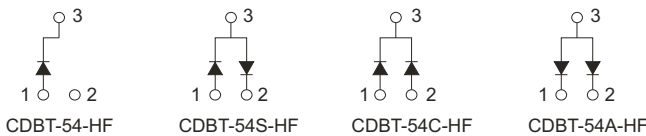

Maximum Ratings (at Ta=25°C unless otherwise noted)

Parameter	Symbol	Conditions	Value	Unit
Peak repetitive peak reverse voltage	V_{RRM}		30	V
Working peak reverse voltage	V_{RWM}			
DC blocking voltage	V_R			
Forward continuous current	I_F		200	mA
Non-repetitive peak forward surge current	I_{FSM}	t=8.3ms	600	mA
Power dissipation	P_D		200	mW
Thermal resistance	$R_{\theta JA}$	Junction to ambient	500	°C/W
Junction temperature range	T_J		125	°C
Storage temperature range	T_{STG}		-55 to +150	°C

Electrical Characteristics (at $T_a=25^\circ\text{C}$ unless otherwise noted)

Parameter	Symbol	Conditions	Min.	Typ.	Max.	Unit
Reverse voltage	$V_{(BR)}$	$I_R = 100\mu\text{A}$	30			V
Forward voltage	V_F	@ $I_F = 0.1\text{mA}$ @ $I_F = 1\text{mA}$ @ $I_F = 10\text{mA}$ @ $I_F = 30\text{mA}$ @ $I_F = 100\text{mA}$			0.24 0.32 0.40 0.50 1.00	V
Reverse current	I_R	@ $V_R = 25\text{V}$			2	μA
Diode capacitance	C_J	$V_R = 1\text{V}, f = 1.0\text{MHz}$			10	pF
Reverse recovery time	T_{rr}	$I_F = I_R = 10\text{mA},$ $I_{RR} = 0.1I_R, R_L = 100\Omega$			5	nS

RATING AND CHARACTERISTIC CURVES (CDBT-54/S/C/A-HF)

Fig.1 - Forward Characteristics

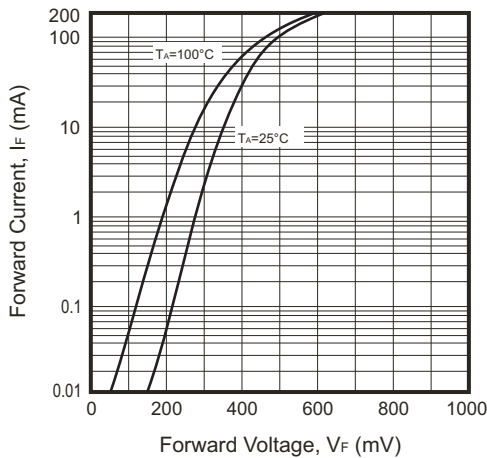

Fig.2 - Reverse Characteristics

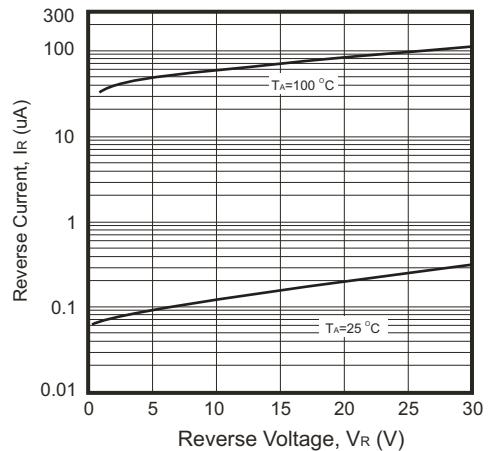

Fig.3 - Capacitance Characteristics

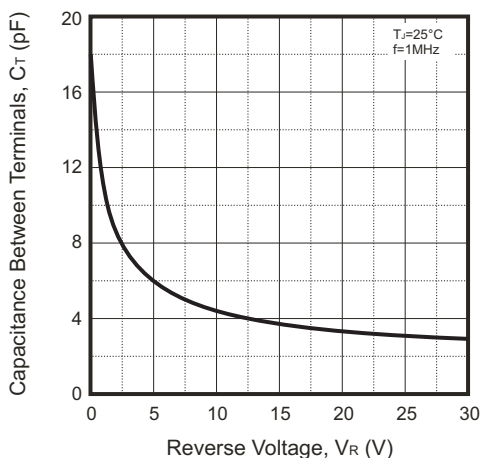
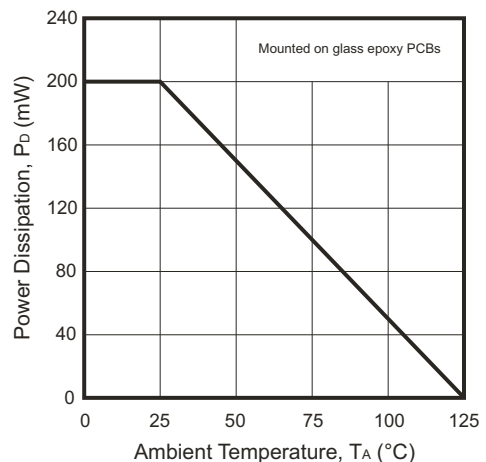
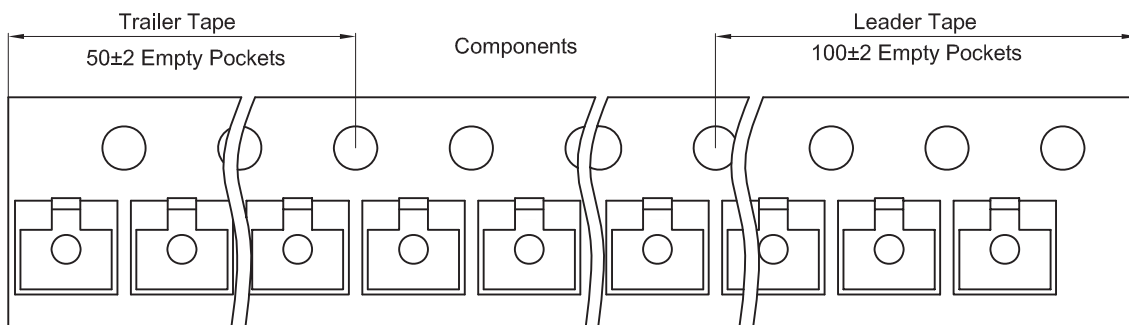
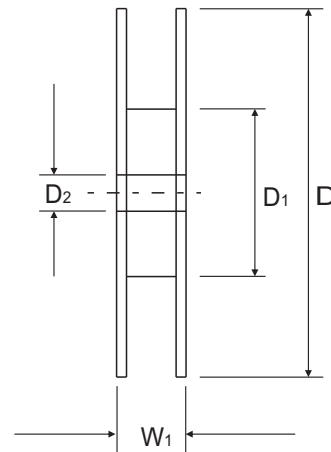
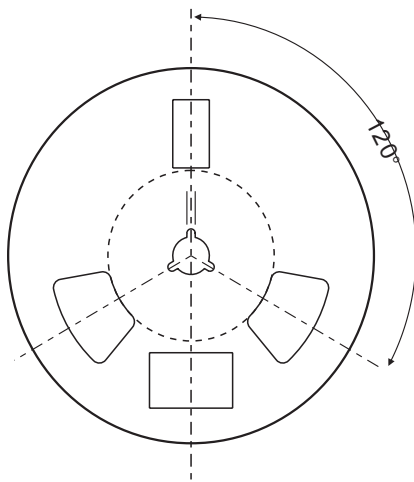
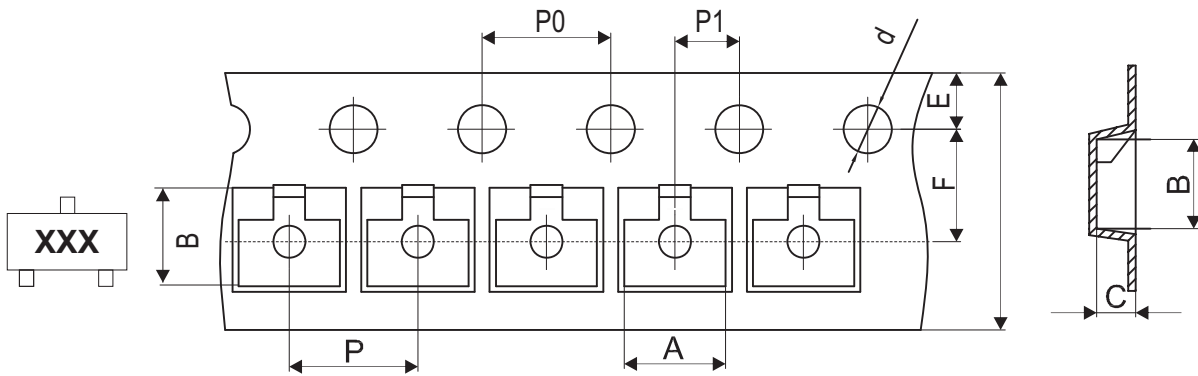

Fig.4 - Power Derating Curve



Reel Taping Specification



SOT-23	SYMBOL	A	B	C	d	D	D1	D2
	(mm)	3.15 ± 0.10	2.77 ± 0.10	1.22 ± 0.10	1.50 ± 0.10	178.00 ± 2.00	54.40 ± 1.00	13.00 ± 1.00
	(inch)	0.124 ± 0.004	0.109 ± 0.004	0.048 ± 0.004	0.059 ± 0.004	7.008 ± 0.079	2.142 ± 0.039	0.512 ± 0.039

SOT-23	SYMBOL	E	F	P	P0	P1	W	W1
	(mm)	1.75 ± 0.10	3.50 ± 0.10	4.00 ± 0.10	4.00 ± 0.10	2.00 ± 0.10	8.00 + 0.30 / - 0.10	12.30 ± 1.00
	(inch)	0.069 ± 0.004	0.138 ± 0.004	0.157 ± 0.004	0.157 ± 0.004	0.079 ± 0.004	0.315 + 0.012 / - 0.004	0.484 ± 0.039

Marking Code

Part Number	Marking Code	
CDBT-54-HF	KL1	JV3 Σ
CDBT-54A-HF	KL2	B6 Σ
CDBT-54C-HF	KL3	5C Σ
CDBT-54S-HF	KL4	LD3 Σ

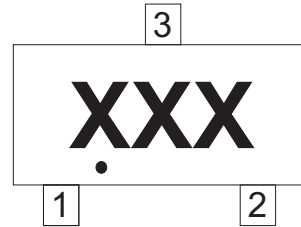

XXX = Product type marking code
Solid dot = Halogen free parts

Month Code:

Month	Odd Year (per A.D.)	Even Year (per A.D.)
Jan	1	E
Feb	2	F
Wer	3	H
Apr	4	J
May	5	K
Jun	6	L

Month	Odd Year (per A.D.)	Even Year (per A.D.)
Jul	7	N
Aug	8	P
Sep	9	U
Oct	T	X
Nov	V	Y
Dec	C	Z

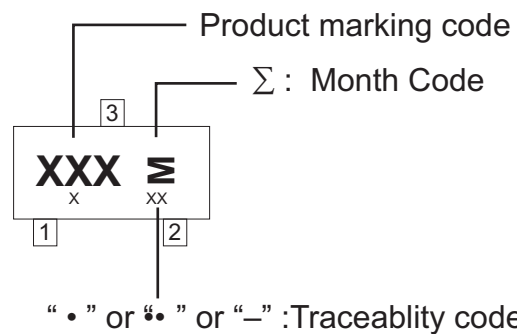

Suggested PAD Layout

SIZE	SOT-23	
	(mm)	(inch)
A	0.80	0.031
B	0.60	0.024
C	1.90	0.075
D	2.02	0.080
E	2.82	0.111

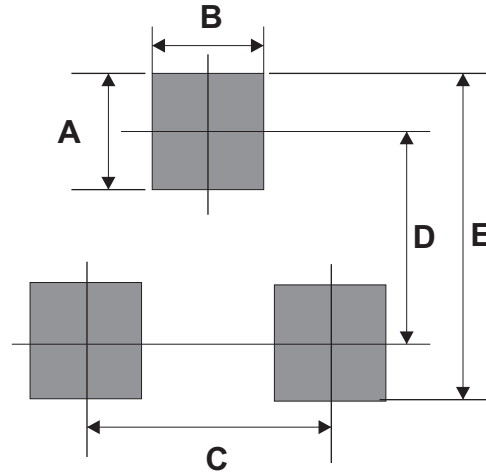

Standard Packaging

Case Type	Qty Per Reel	Reel Size
	(Pcs)	(inch)
SOT-23	3,000	7

Mouser Electronics

Authorized Distributor

Click to View Pricing, Inventory, Delivery & Lifecycle Information:

[Comchip Technology:](#)

[CDBT-54-HF](#)