

## GRF1202

### LOG AVERAGE POWER DETECTOR

#### 0.4 to 8 GHz

#### FEATURES

- Detector Slope: 0.027 volts per dB (-60 to +5 dBm)
- Linear Logarithmic Power Detector
- RoHS Compliant

#### APPLICATIONS

- High-volume, cost-sensitive logarithmic power detector applications

#### ORDERING INFORMATION

[Buy it Now](#)

#### DESCRIPTION

The GRF1202 is a logarithmic, average power detector IC designed for cost-sensitive applications in the 0.4 to 8 GHz frequency range.

The device can be operated from a supply voltage range of 3.3 to 6.0 volts and housed in a 1.5 x 1.5 x 0.5 mm 6-pin plastic DFN package.

Please consult with the GRF applications engineering team for additional performance data.

Additional tunes can be found on the GRF1202 “Custom Tunes” product page: [GRF1202 Custom Tunes](#)

#### BLOCK DIAGRAM

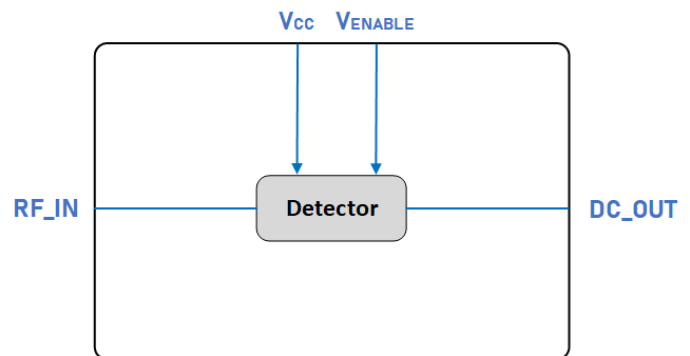

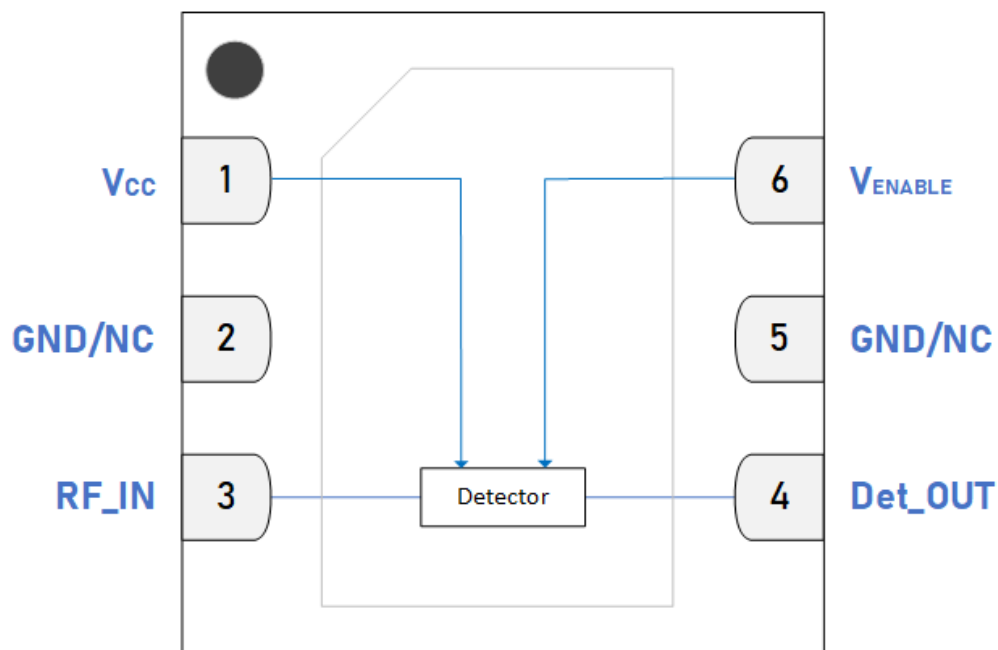

**Pin Out (Top View)**



## Pin Assignments

Pin	Name	Description	Note
1	V <sub>CC</sub>	Supply Voltage	Connects to V <sub>CC</sub> through an external resistor.
2	GND/NC	Ground or No Connect	No internal connection to die.
3	RF_IN	Detector RF Input	An external DC blocking capacitor must be used.
4	Det_OUT	Detector DC Output	DC coupled to measure detected output power.
5	GND/NC	Ground or No Connect	No internal connection to die.
6	V <sub>ENABLE</sub>	Enable Voltage Input	Can be connected to V <sub>CC</sub> through an external resistor.
PKG BASE	GND	Ground	Provides DC and RF ground for detector, as well as thermal heat sink. Recommend multiple 8 mil vias beneath the package for optimal RF and thermal performance. Refer to evaluation board top layer graphic on schematic page.

## Absolute Ratings

Parameter	Symbol	Min.	Max.	Unit
Supply Voltage	V	0	6	V
RF Input Power: Load VSWR < 2:1, Modulation: CW	P <sub>IN MAX</sub>		20	dBm
Operating Temperature (Package Base)	T <sub>PKG BASE</sub>	-40	105	°C
Maximum Channel Temperature (MTTF > 10 <sup>6</sup> Hours)	T <sub>MAX</sub>		170	°C

## Electrostatic Discharge

Human Body Model	HBM	1000		V
------------------	-----	------	--	---

## Storage

Storage Temperature	T <sub>STG</sub>	-65	150	°C
Moisture Sensitivity Level	MSL		1	--



**Caution! ESD Sensitive Device.**

**Exceeding Absolute Maximum Rating conditions may cause permanent damage.**

Note: For additional information, please refer to [Manufacturing Note MN-001 - Packaging and Manufacturing Information](#).



All Guerrilla RF products are provided in RoHS compliant lead (Pb)-free packaging. For additional information, please refer to the [Certificate of RoHS Compliance](#).



## Recommended Operating Conditions

Parameter	Symbol	Specification			Unit	Condition
		Min.	Typ.	Max.		
Supply Voltage	$V_{CC}$	3.3	5	6	V	
Operating Temperature Range	$T_{PKG\ BASE}$	-40		105	°C	
RF Frequency Range	$F_{RF}$	0.4	2	8	GHz	See notes 1 & 2.
RF1 Port Impedance	$Z_{RFIN}$		50		$\Omega$	Single-ended.

**Note 1:** Operation outside of this range is supported by using different custom tunes. Examples of other optimized tunes can be found here: [GRF1202 Custom Tunes](#)

**Note 2:** Contact the Guerrilla RF Applications team for guidance on optimizing the tuning of the device for alternative bands.



## Nominal Operating Parameters - General

The following conditions apply unless noted otherwise; Typical Application Schematic,  $V_{CC} = 5\text{ V}$ ,  $I_{CC} = 18\text{ mA}$ ,  $50\ \Omega$  system impedance,  $F_{TEST} = 2.0\text{ GHz}$ ,  $T_{PKG\ BASE} = 25\text{ }^\circ\text{C}$ . Evaluation board losses are included within the specifications.

Parameter	Symbol	Specification			Unit	Condition
		Min.	Typ.	Max.		
Test Frequency (50 $\Omega$ source)	$F_{TEST}$		2		GHz	$V_{CC} = 5\text{ V}$ .
DC_Out (no RF applied)	DC_Out		1.7		V	
DC_Out (-60 dBm RF Input Power)	DC_Out		1.7		V	
DC_Out (-40 dBm RF Input Power)	DC_Out		2.1		V	
DC_Out (-20 dBm RF Input Power)	DC_Out		2.7		V	
DC_Out (0 dBm RF Input Power)	DC_Out		3.3		V	
DC_Out (5 dBm RF Input Power)	DC_Out		3.5		V	
Detector Output Rise Time	$T_{RISE}$		450		ns	
Detector Output Fall Time	$T_{FALL}$		440		ns	
Supply Current	$I_{CC}$		18		mA	$V_{CC} = 5\text{ V}$ .
Maximum Die Temperature Package Heat Sink Temperature = 85 $^\circ\text{C}$ (Infrared Scan).	$T_{MAX}$		92		$^\circ\text{C}$	$V_{CC} = 5\text{ V}$ .

## Nominal Operating Parameters - General

The following conditions apply unless noted otherwise; Typical Application Schematic,  $V_{CC} = 3.4\text{ V}$ ,  $I_{CC} = 18\text{ mA}$ ,  $50\ \Omega$  system impedance,  $F_{TEST} = 2.0\text{ GHz}$ ,  $T_{PKG\ BASE} = 25\text{ }^\circ\text{C}$ . Evaluation board losses are included within the specifications.

Parameter	Symbol	Specification			Unit	Condition
		Min.	Typ.	Max.		
Test Frequency (50 $\Omega$ source)	$F_{TEST}$		2		GHz	$V_{CC} = 3.4\text{ V}$ .
DC_Out (no RF applied)	DC_Out		0.4		V	
DC_Out (-60 dBm RF Input Power)	DC_Out		0.5		V	
DC_Out (-40 dBm RF Input Power)	DC_Out		0.8		V	
DC_Out (-20 dBm RF Input Power)	DC_Out		1.4		V	
DC_Out (0 dBm RF Input Power)	DC_Out		2.0		V	
DC_Out (5 dBm RF Input Power)	DC_Out		2.1		V	
Detector Output Rise Time	$T_{RISE}$		460		ns	
Detector Output Fall Time	$T_{FALL}$		450		ns	
Supply Current	$I_{CC}$		18		mA	$V_{CC} = 3.4\text{ V}$ .
Maximum Die Temperature Package Heat Sink Temperature = 85 $^\circ\text{C}$ (Infrared Scan).	$T_{MAX}$		TBD		$^\circ\text{C}$	$V_{CC} = 3.4\text{ V}$ .

### Thermal Data

Thermal Resistance (Infrared Scan)	$\Theta_{JC}$		61		$^\circ\text{C}/\text{W}$	On Standard Evaluation Board (see note 2).
------------------------------------	---------------	--	----	--	---------------------------	--

**Note 2:** MTTF >  $10^6$  hours for  $T_j \leq 170\text{ }^\circ\text{C}$

### GRF1202 Typical Operating Curves: Pin = -60 to +5 dBm

GRF1202 Vout vs Pin at Frequency = 700 MHz

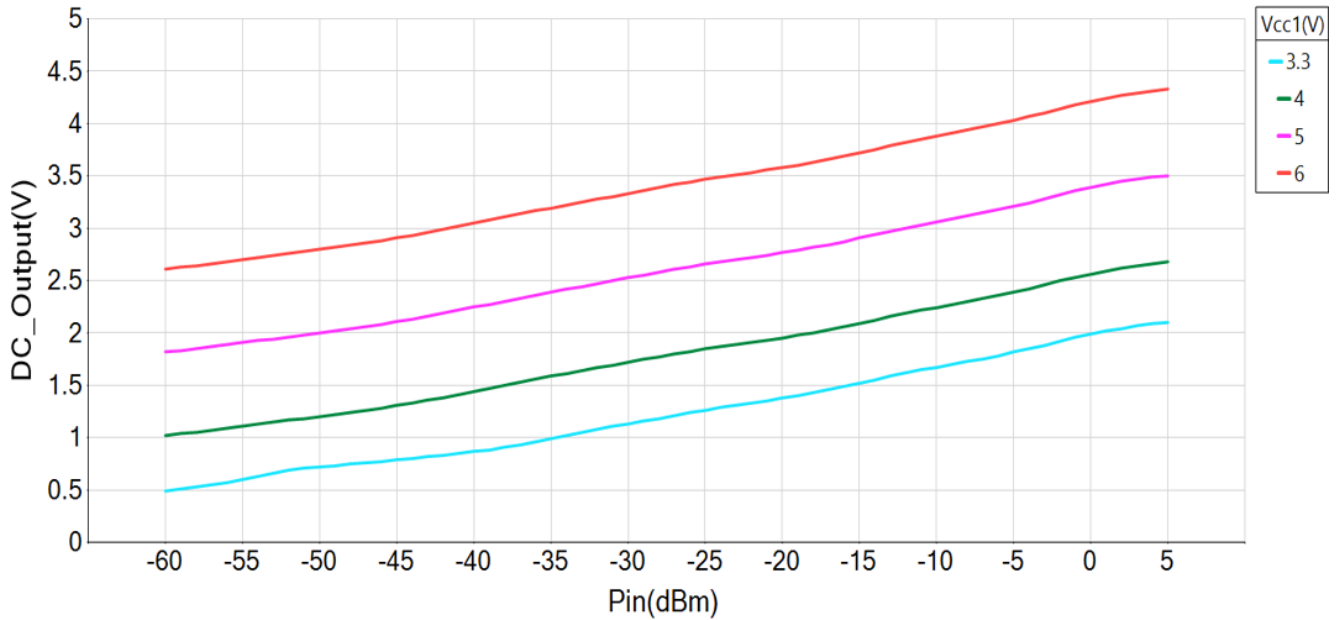

GRF1202 Vout vs Pin at Frequency = 1400 MHz

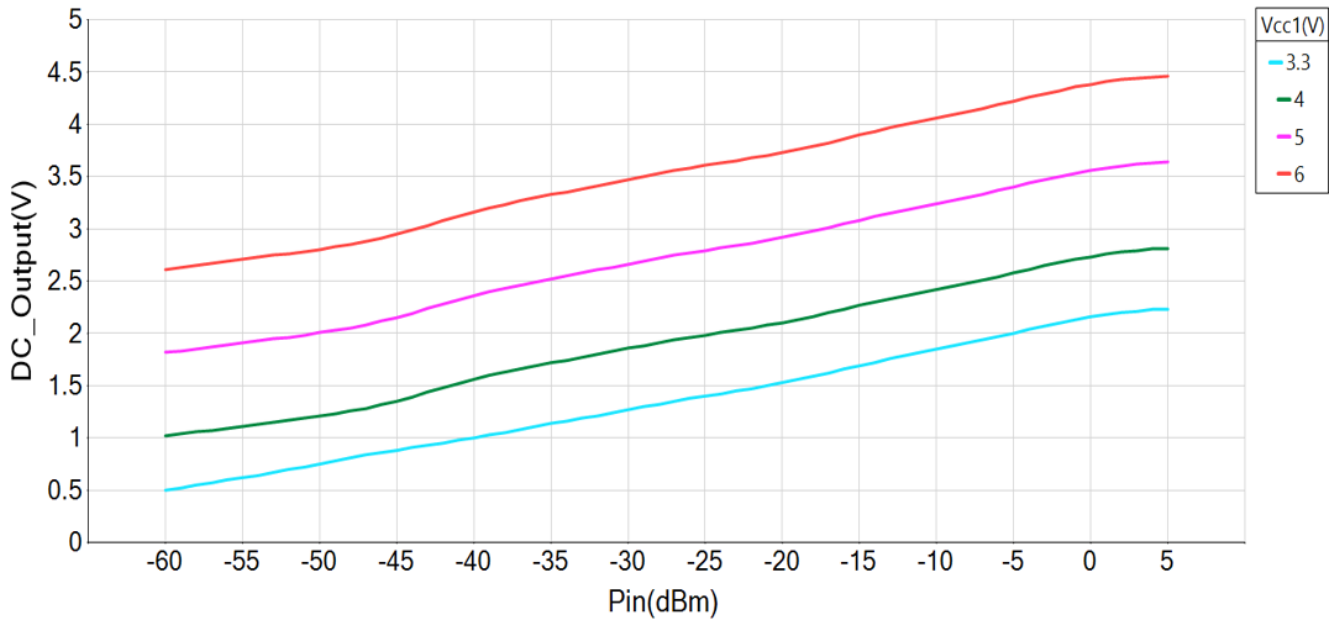



### GRF1202 Typical Operating Curves: Pin = -60 to +5 dBm

GRF1202 Vout vs Pin at Frequency = 2000 MHz

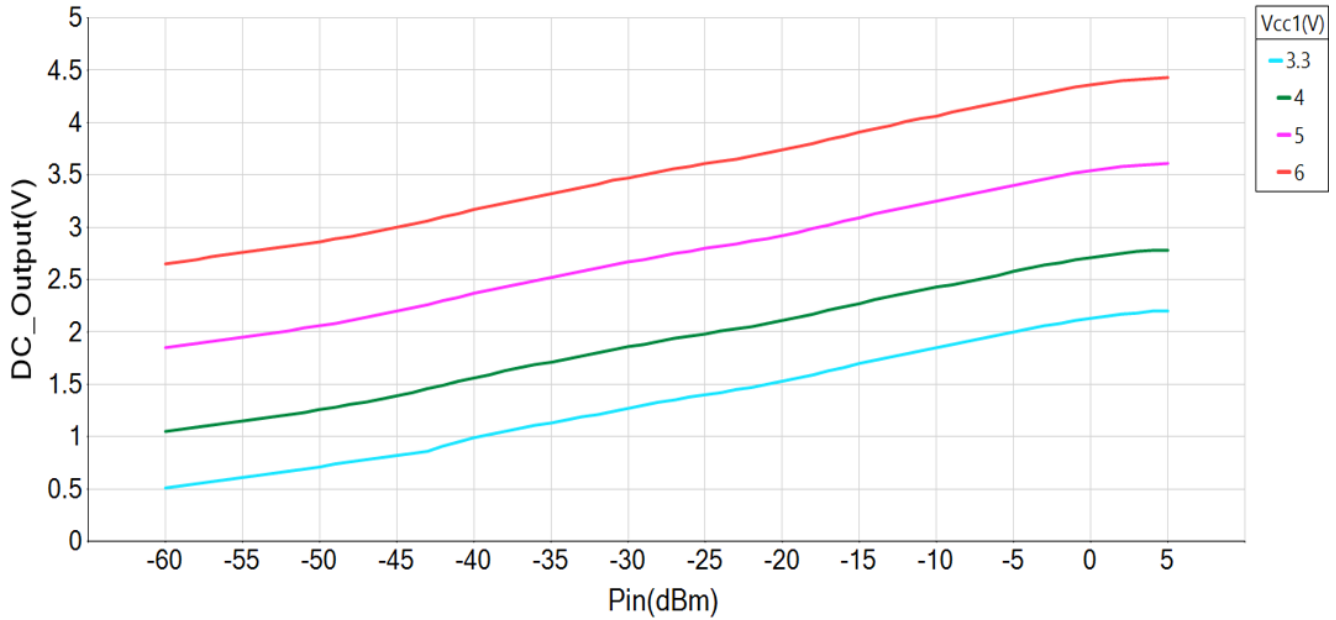

GRF1202 Vout vs Pin at Frequency = 3000 MHz

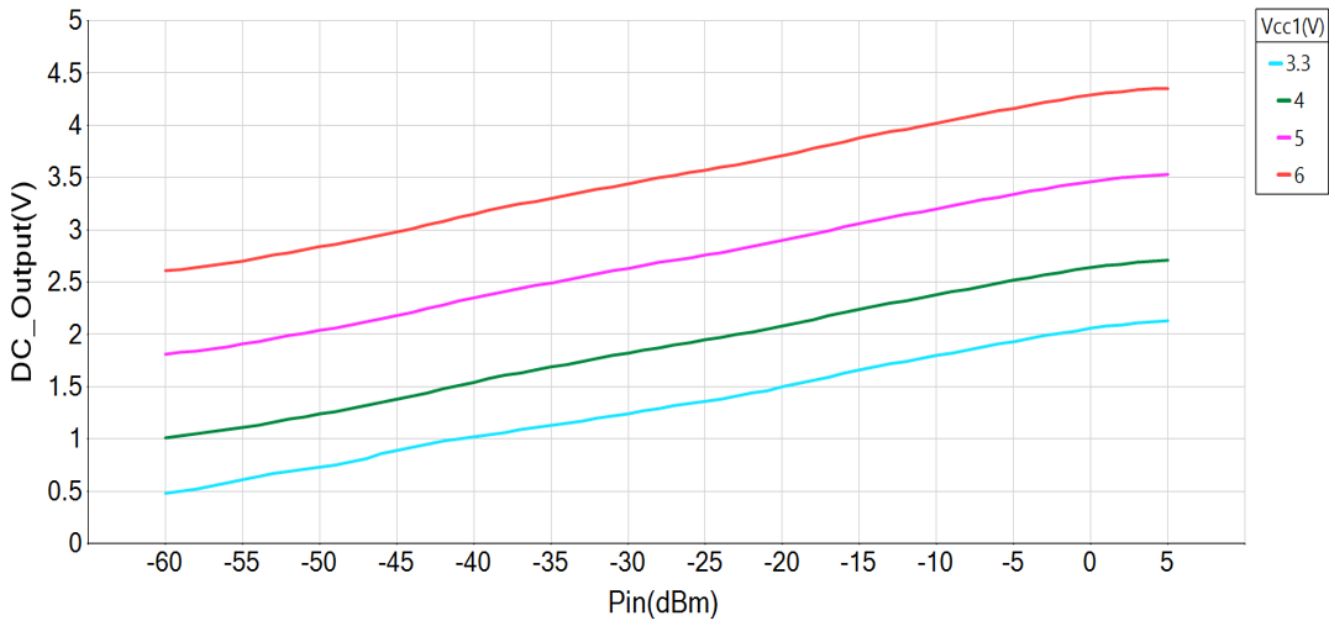

### GRF1202 Typical Operating Curves: Pin = -60 to +5 dBm

GRF1202 Vout vs Pin at Frequency = 4000 MHz

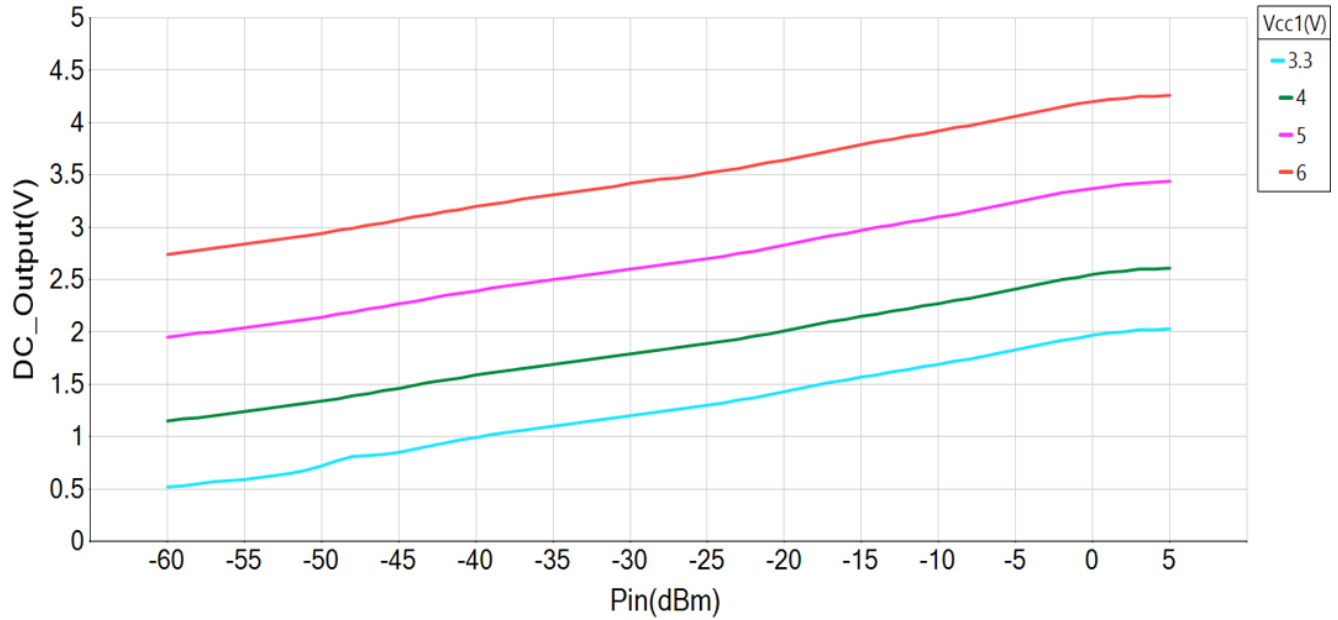

GRF1202 Vout vs Pin at Frequency = 4500 MHz

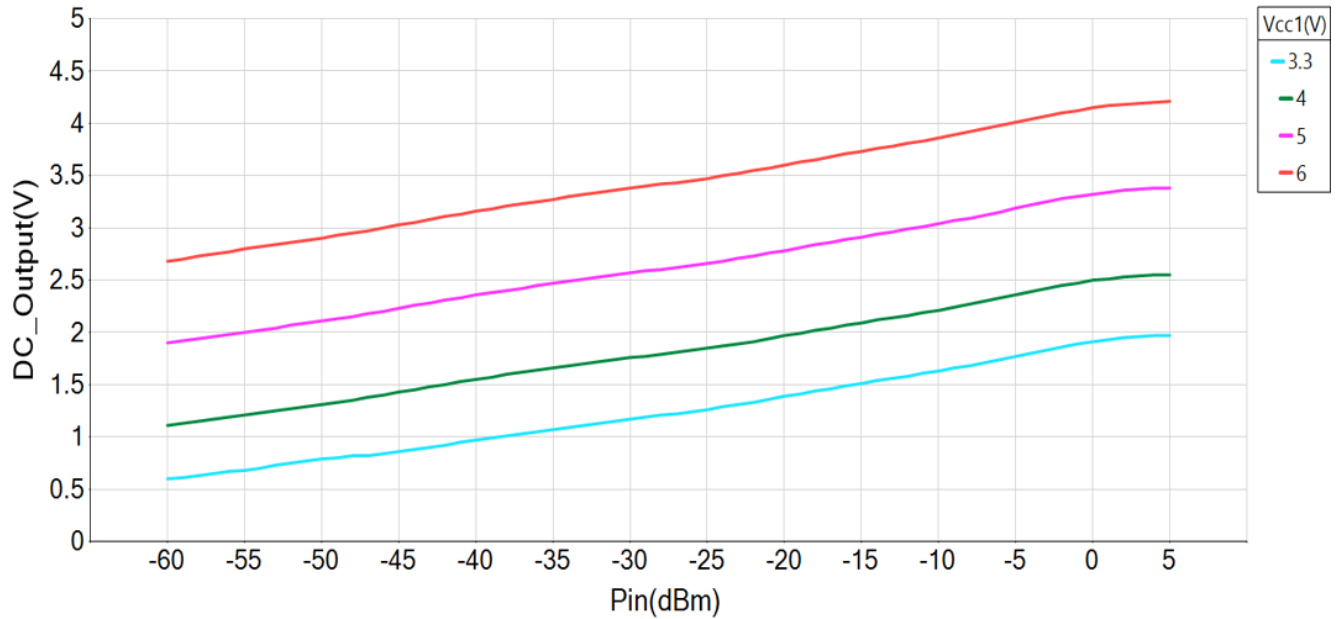

### GRF1202 Typical Operating Curves: Pin = -60 to +5 dBm

GRF1202 Vout vs Pin at Frequency = 5000 MHz

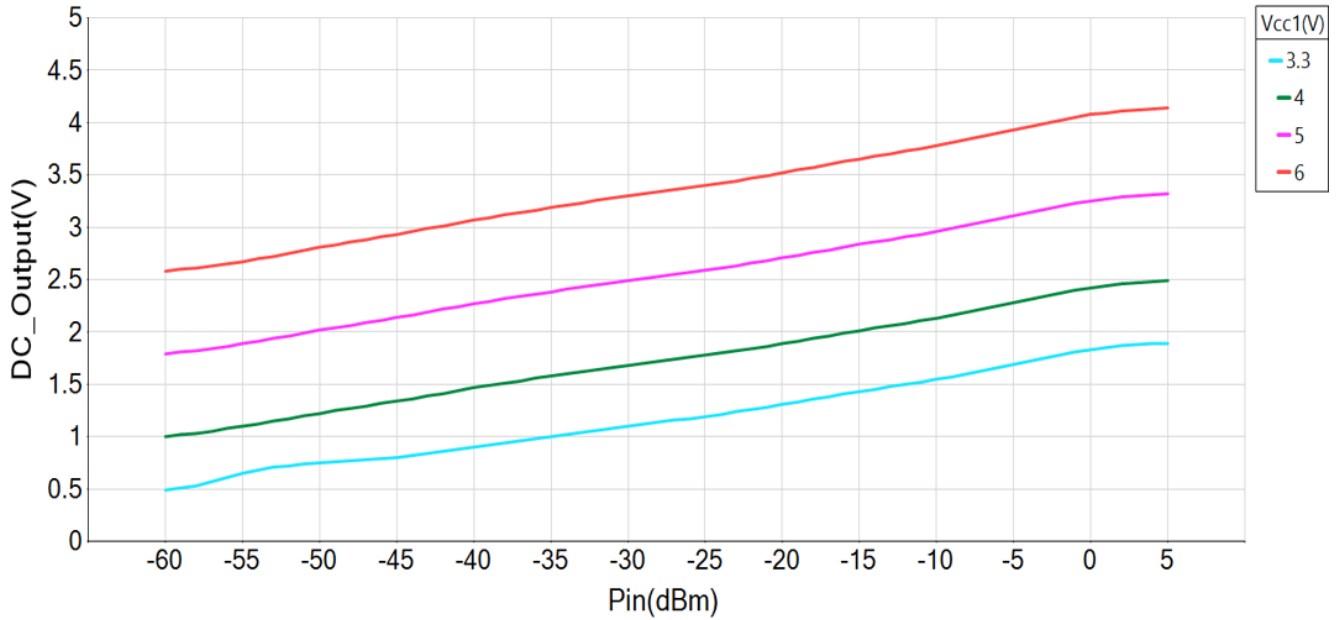

GRF1202 Vout vs Pin at Frequency = 5500 MHz

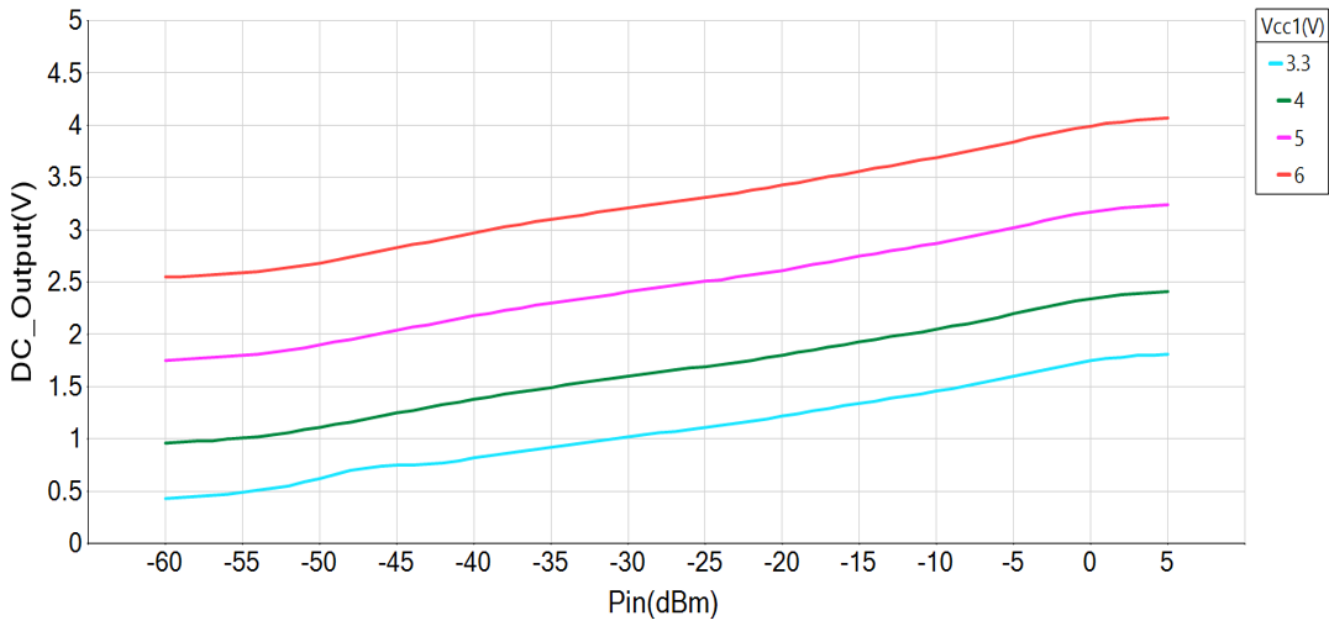

### GRF1202 Typical Operating Curves: Pin = -60 to +5 dBm

GRF1202 Vout vs Pin at Frequency = 6000 MHz

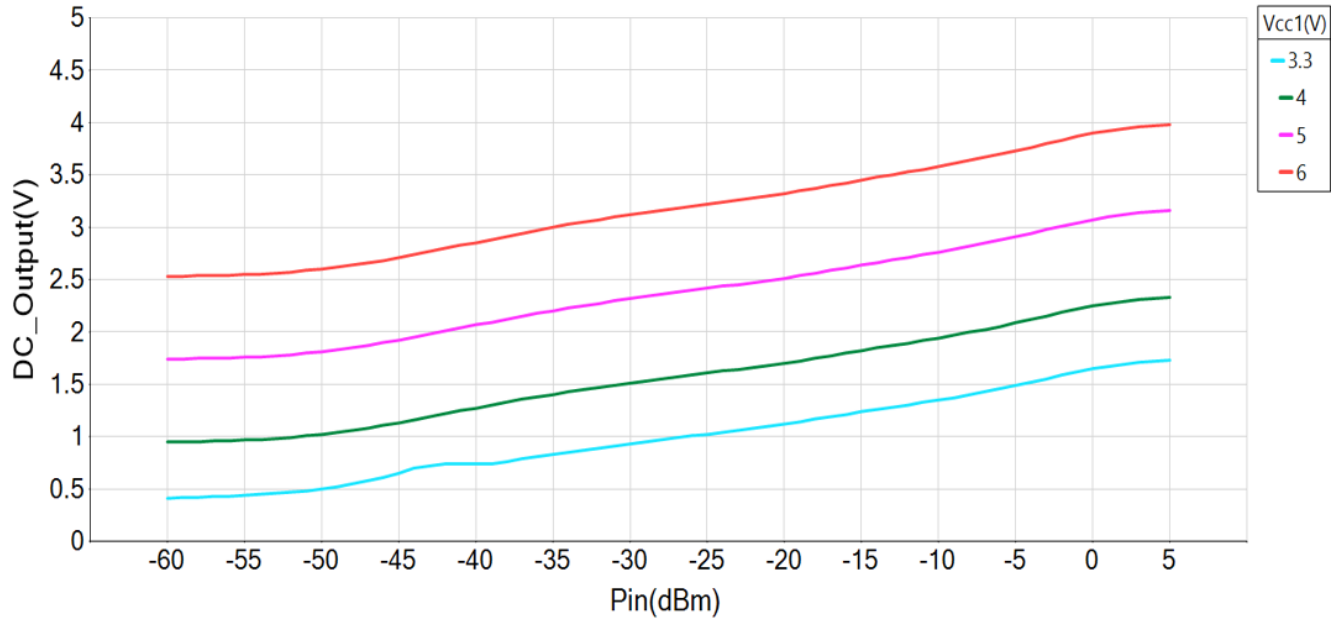

### GRF1202 Typical Operating Curves: Pin = -60 to +5 dBm

GRF1202 Vout vs Pin at Modulation = CW

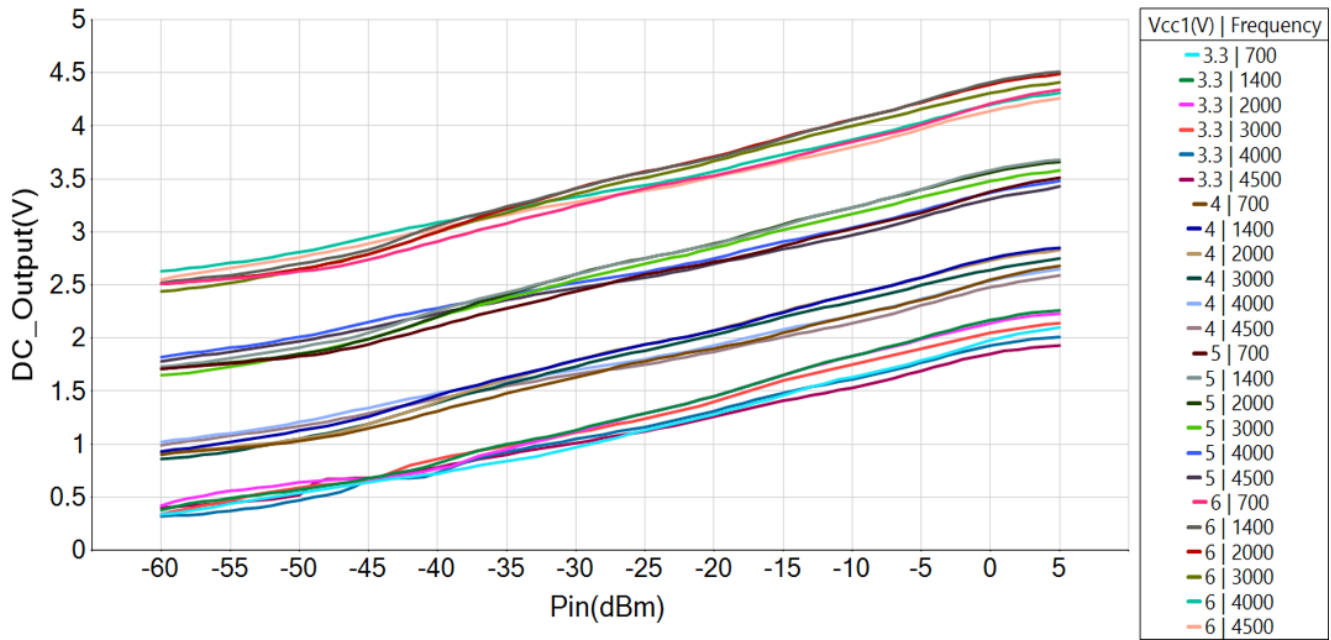

GRF1202 Vout vs Pin at Modulation = LTE\_10MHz\_50RB

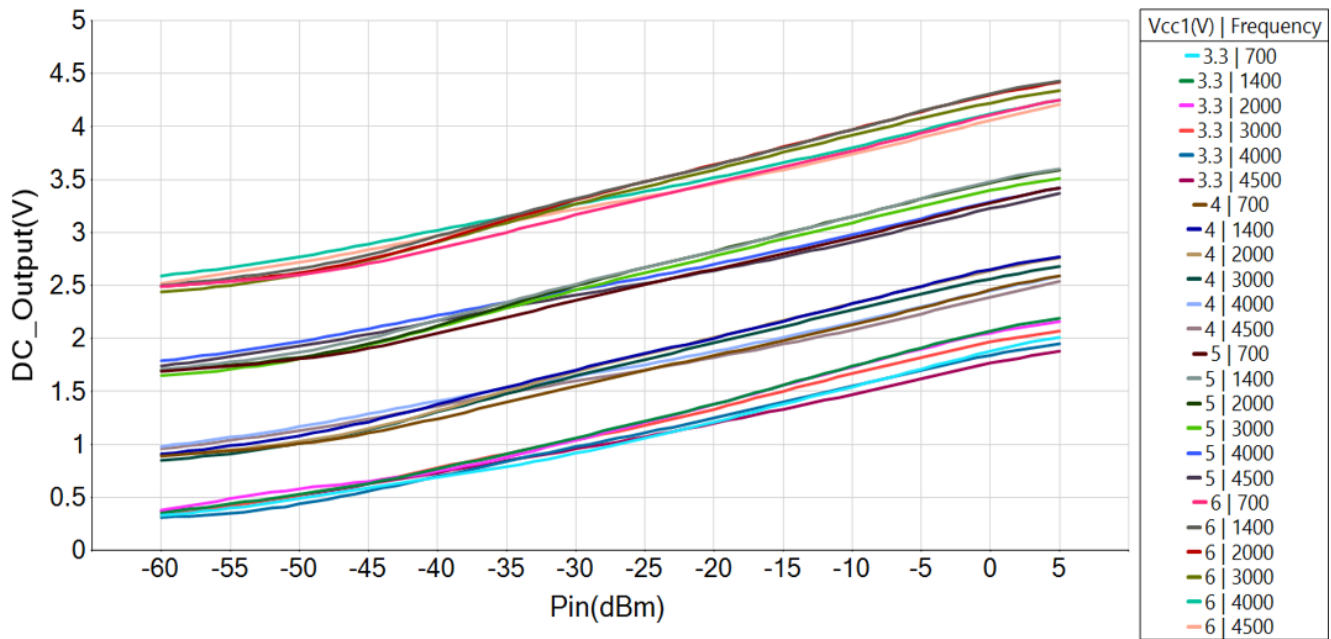

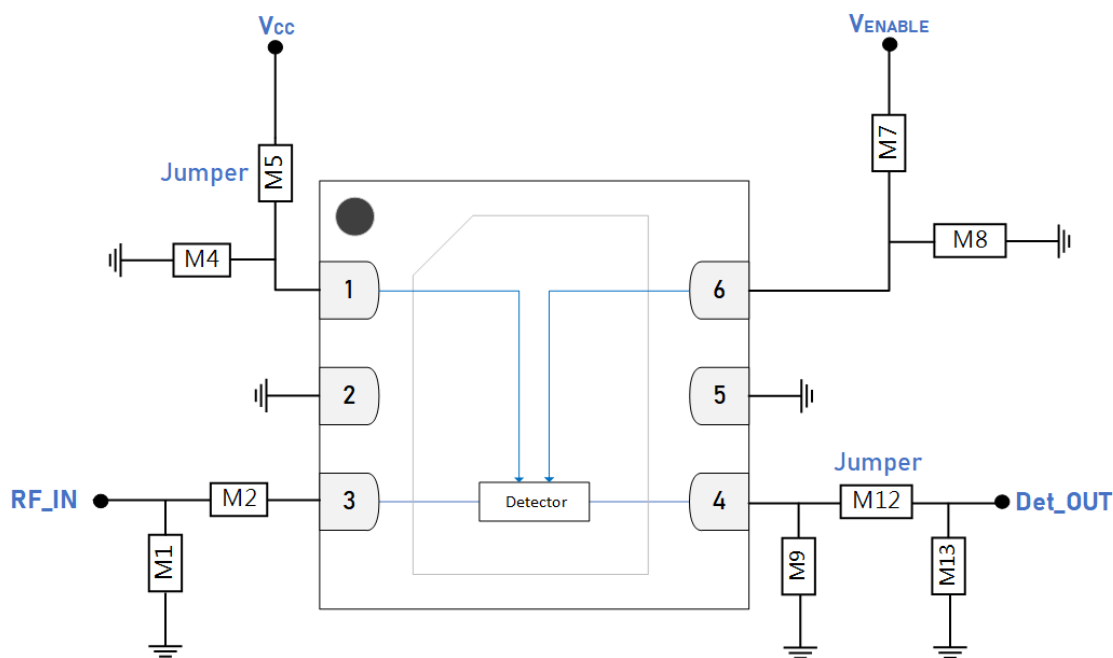

GRF1202 Evaluation Board Schematic

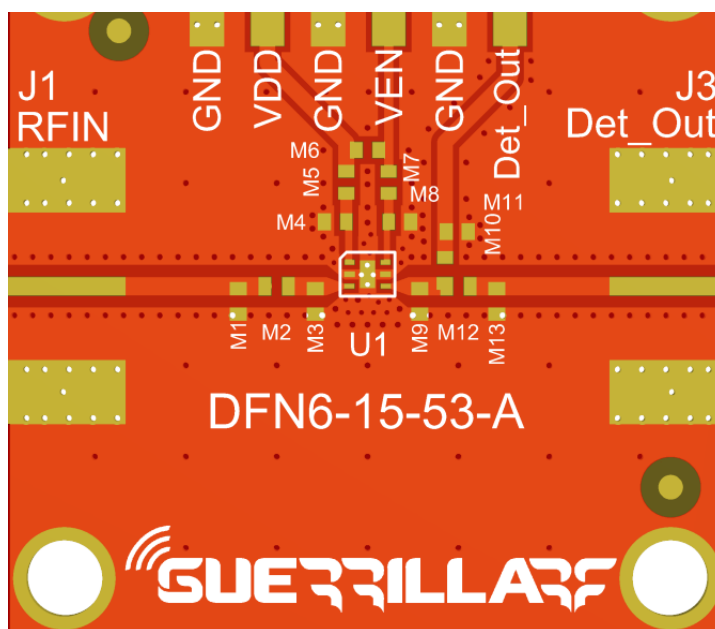

GRF1202 Evaluation Board Assembly Diagram



**GRF1202 Evaluation Board Assembly Diagram Reference: 5 V, 25 mA**

Component	Type	Manufacturer	Family	Value	Package Size	Substitution
M1	Resistor	Various	5%	50 Ω	0402	ok
M2	Capacitor	Murata	GRM	100 pF	0402	ok
M3, M6, M10	DNP	--	--	--	--	--
M4	Capacitor	Murata	GRM	0.1 μF	0402	ok
M5	Resistor (jumper)	Various	5%	0 Ω	0402	ok
M8	Capacitor	Murata	GRM	10 pF	0402	ok
M7	Resistor	Various	5%	806 Ω	0402	ok
M9	Capacitor	Murata	GRM	100 pF	0402	ok
M12	Resistor (jumper)	Various	5%	0 Ω	0402	ok
M13	Resistor	Various	5%	10 kΩ	0402	ok
Evaluation Board	DFN6-15-53-A					

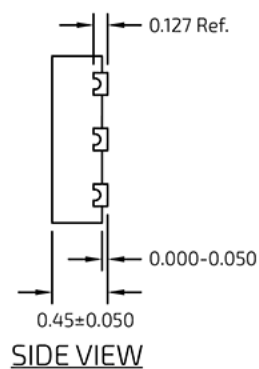
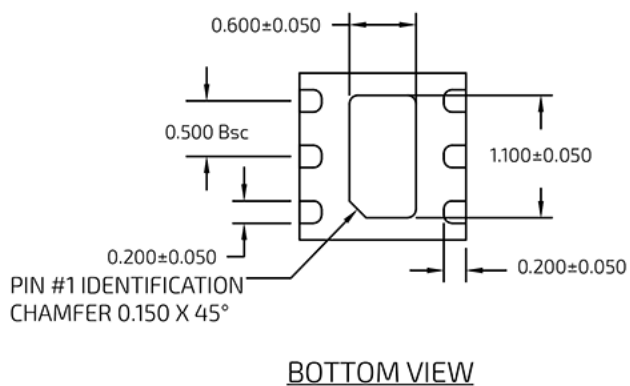
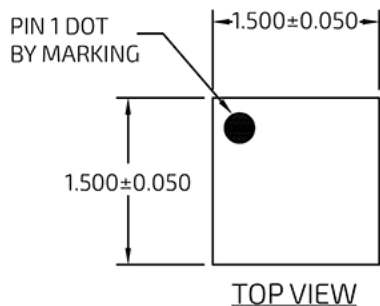

### DFN 6 1.5x1.5mm Package Dimensions



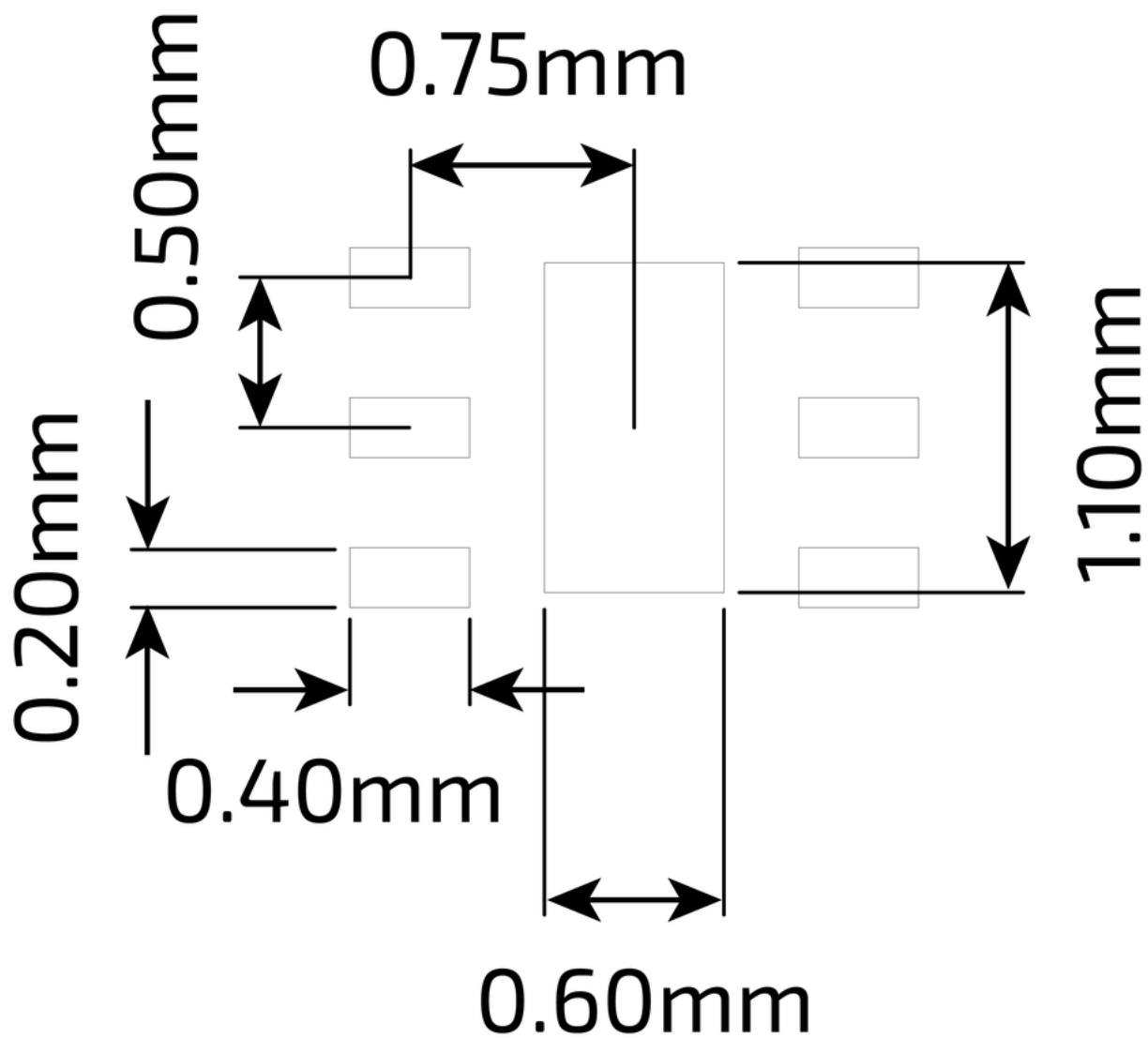

DFN 6 1.5x1.5mm Suggested PCB Footprint (Top View)

**Package Marking Diagram**



Line 1: "Y" = YEAR (single digit). "WW" = WORK WEEK the Device was assembled.  
 Line 2: "XXXX" = Device Part Number.

**Tape and Reel Information**

Guerrilla RF's tape and reel specification complies with Electronics Industries Association (EIA) standards for "Embossed Carrier Tape of Surface Mount Components for Automatic Handling" (reference EIA-481). Devices are loaded with pins down into the carrier pocket with protective cover tape and reeled onto a plastic reel. Each reel is packaged in a cardboard box. There are product labels on the reel, the protective ESD bag, and the outside surface of the box. For the latest reel specifications and package information (including units/reel), please visit [Package Manufacturing Information](#) | [Guerrilla RF](#) (guerrilla-rf.com).

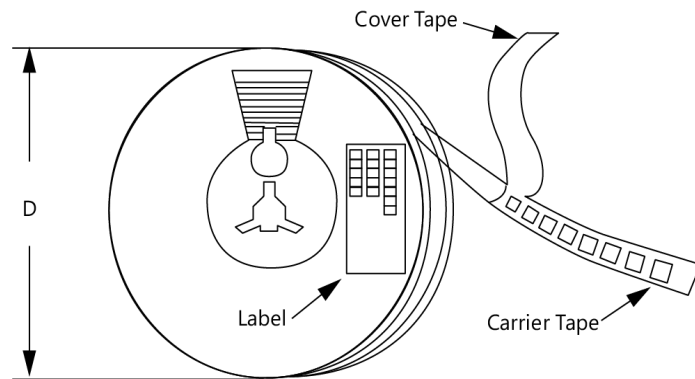

Tape and Reel Packaging with Reel Diameter Noted (D)

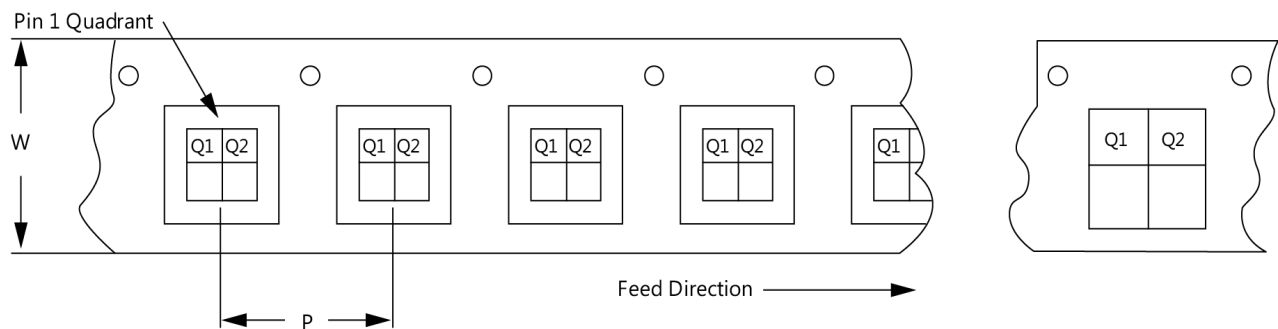

Carrier Tape Width (W), Pitch (P), Feed Direction and Pin 1 Quadrant Information



**Revision History**

<b>Revision Date</b>	<b>Description of Change</b>
July 31, 2023	Advance Data Sheet.
August 30, 2023	Preliminary Data Sheet.
October 23, 2023	Updated EVB schematic & BOM (removed M7, changed M8 to 10 pF, changed M9 to 806 Ω). Added "RoHS Compliant" to Features list on page-1.
December 9, 2023	Changed lower end of Frequency Range from 100 MHz to 400 MHz.
December 18, 2023	Changed upper end of Frequency Range from +4 GHz to 6 GHz and added 0.7 to 6 GHz Plots.
September 18, 2024	Release Ø Data Sheet. Updated specifications, test schematic and BOM. Added new evaluation board.
October 4, 2024	Raised upper frequency range from 6 GHz to 8 GHz.



Data Sheet Classifications

Data Sheet Status	Notes
Advance	S-parameter and NF data based on EM simulations for the fully packaged device using foundry-supplied transistor S-parameters. Linearity estimates based on device size, bias condition and experience with related devices.
Preliminary	All data based on evaluation board measurements taken within the Guerrilla RF Applications Lab. Any MIN/MAX limits represented within the data sheet are based solely on <i>estimated</i> part-to-part variations and process spreads. All parametric values are subject to change pending the collection of additional data.
Release Ø	All data based on measurements taken with <i>production-released</i> material. TYP values are based on a combination of ATE and bench-level measurements, with MIN/MAX limits defined using <i>modelled estimates</i> that account for part-to-part variations and expected process spreads. Although unlikely, future refinements to the TYP/MIN/MAX values may be in order as multiple lots are processed through the factory.
Release A-Z	All data based on measurements taken with production-released material <i>derived from multiple lots which have been fabricated over an extended period of time</i> . MIN/MAX limits may be refined over previous releases as more statistically significant data is collected to account for process spreads.

Information in this data sheet is specific to the Guerrilla RF, Inc. ("Guerrilla RF") product identified.

This data sheet, including the information contained in it, is provided by Guerrilla RF as a service to its customers and may be used for informational purposes only by the customer. Guerrilla RF assumes no responsibility for errors or omissions on this data sheet or the information contained herein. Information provided is believed to be accurate and reliable, however, no responsibility is assumed by Guerrilla RF for its use, nor for any infringement of patents, or other rights of third parties, resulting from its use. Guerrilla RF assumes no liability for any data sheet, data sheet information, materials, products, product information, or other information provided hereunder, including the sale, distribution, reproduction or use of Guerrilla RF products, information or materials.

No license, whether express, implied, by estoppel, by implication or otherwise granted by this data sheet for any intellectual property of Guerrilla RF, or any third party, including without limitation, patents, patent rights, copyrights, trademarks, and trade secrets. All rights are reserved by Guerrilla RF.

All information herein, products, product information, data sheets, and data sheet information are subject to change and availability without notice. Guerrilla RF reserves the right to change component circuitry, recommended application circuitry and specifications at any time without prior notice. Guerrilla RF may further change its data sheet, product information, documentation, products, services, specifications or product descriptions at any time, without notice. Guerrilla RF makes no commitment to update any materials or information and shall have no responsibility whatsoever for conflicts, incompatibilities, or other difficulties arising from any future changes.

GUERRILLA RF INFORMATION, PRODUCTS, PRODUCT INFORMATION, DATA SHEETS AND DATA SHEET INFORMATION ARE PROVIDED "AS IS" AND WITHOUT WARRANTY OF ANY KIND, WHETHER EXPRESS, IMPLIED, STATUTORY, OR OTHERWISE, INCLUDING FITNESS FOR A PARTICULAR PURPOSE OR USE, MERCHANTABILITY, PERFORMANCE, QUALITY OR NON-INFRINGEMENT OF ANY INTELLECTUAL PROPERTY RIGHT; ALL SUCH WARRANTIES ARE HEREBY EXPRESSLY DISCLAIMED. GUERRILLA RF DOES NOT WARRANT THE ACCURACY OR COMPLETENESS OF THE INFORMATION, TEXT, GRAPHICS OR OTHER ITEMS CONTAINED WITHIN THESE MATERIALS. GUERRILLA RF SHALL NOT BE LIABLE FOR ANY DAMAGES, INCLUDING BUT NOT LIMITED TO ANY SPECIAL, INDIRECT, INCIDENTAL, STATUTORY, OR CONSEQUENTIAL DAMAGES, INCLUDING WITHOUT LIMITATION, LOST REVENUES OR LOST PROFITS THAT MAY RESULT FROM THE USE OF THE MATERIALS OR INFORMATION, WHETHER OR NOT THE RECIPIENT OF MATERIALS HAS BEEN ADVISED OF THE POSSIBILITY OF SUCH DAMAGE.

Customers are solely responsible for their use of Guerrilla RF products in the Customer's products and applications or in ways which deviate from Guerrilla RF's published specifications, either intentionally or as a result of design defects, errors, or operation of products outside of published parameters or design specifications. Customers should include design and operating safeguards to minimize these and other risks. Guerrilla RF assumes no liability or responsibility for applications assistance, customer product design, or damage to any equipment resulting from the use of Guerrilla RF products outside of stated published specifications or parameters.

# Mouser Electronics

Authorized Distributor

Click to View Pricing, Inventory, Delivery & Lifecycle Information:

[Guerrilla RF:](#)

[GRF1202-EVB](#)