

480LEDs/M COB single color led strip



◆ Product Description

- High density, the light is even and soft
- High efficiency, remarkable energy saving effect
- The maximum luminous angle is 180°
- Chip longitudinal distribution, high reliability;
- Product have good color rendering consistency CRI better than 80 (90 optional)
- SDCM is less than 5 steps
- Standard 5M/roll, length can be customized



◆ Product Datasheet

Product Number	S008480ZB1LZ
Operating Voltage	DC12V
Power/m	9W
SMD Type	COB
LED Qty/m	480
Cutting Length	25mm
Color	Green
Luminance/m	W:842lm
SDCM	<5
Ra	80
Beam Angle	180°
Size (mm)	5000x8mm
IP Rate	IP20/IP65
Operation Temperature	- 25 ~ 60°C

Remarks:

- 1.The above parameters were tested according to integrating sphere TM-30-15.
- 2.The output data is based on IP20 and one merter.
- 3.The data such as power etc, ±15% tolerance is normal.
- 4.IP protection process causes changes in size, CCT and luminous flux.

Outline Dimension (unit mm)

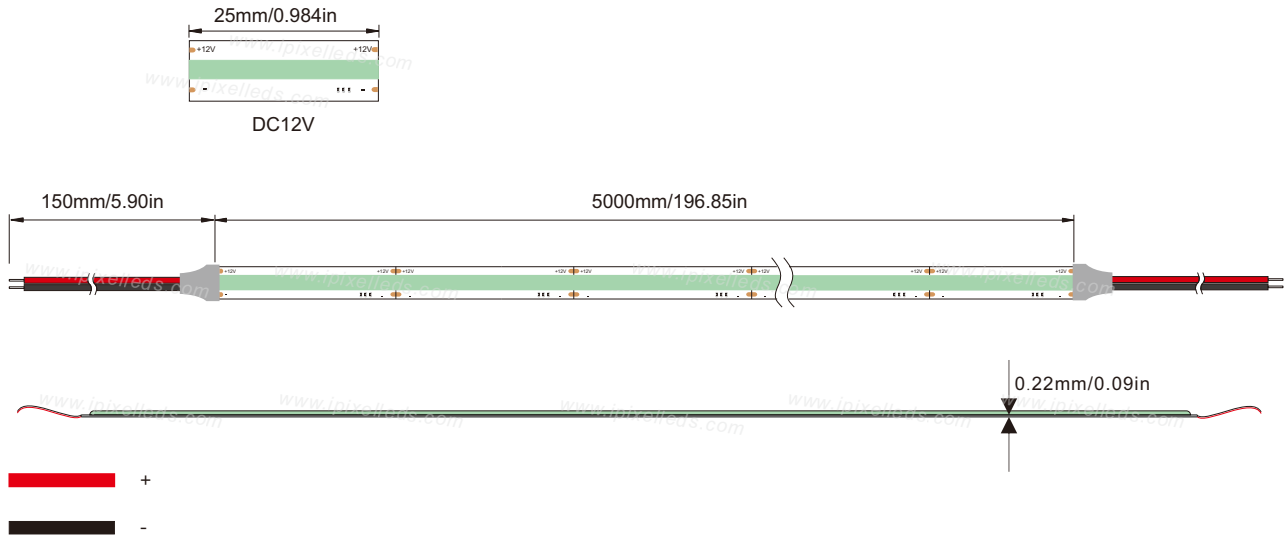

Wiring diagram

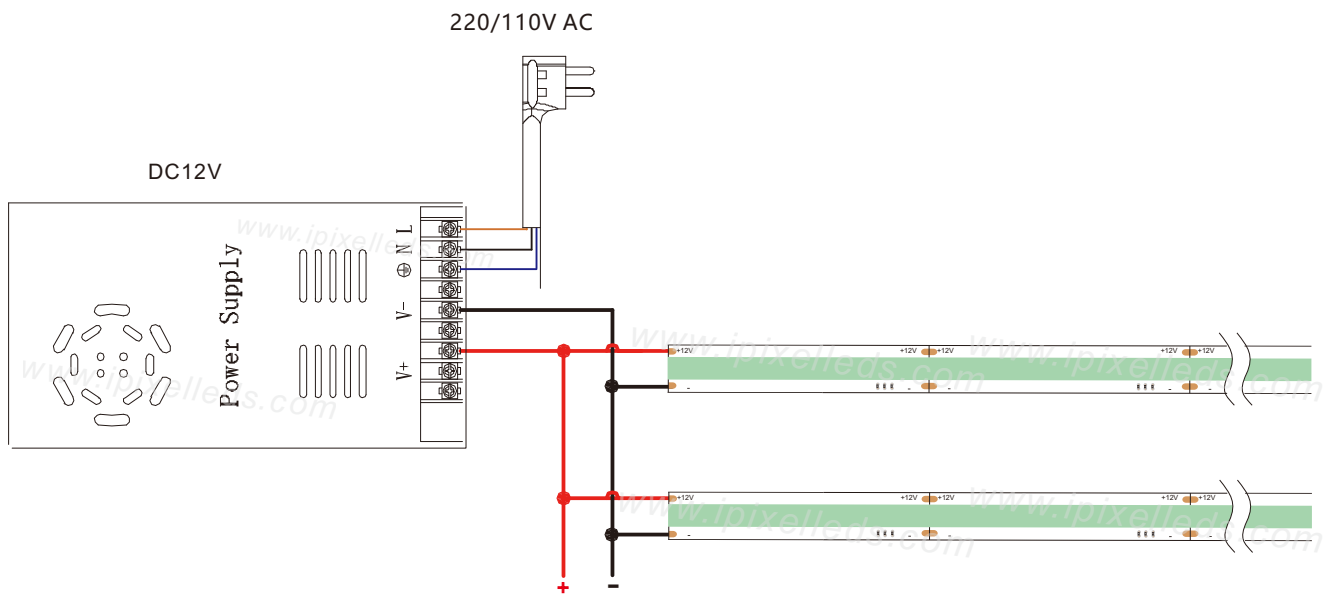

IP Rate



◆ Related products



Power supply



Alum profile



RF dimmer

◆ Schematic diagram of maximum bending prevention

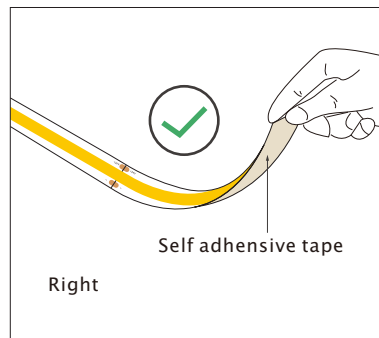
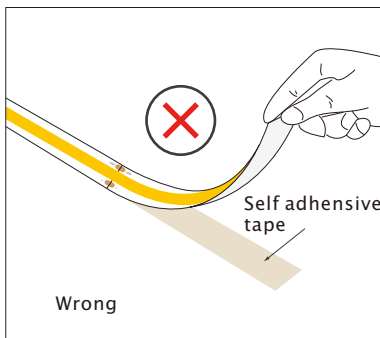

If the led strip needs to be torn up, please make sure that the self adhesive tape is torn with the led strip, otherwise the led strip will be damaged

When install the led strip, please note the installation technique. The led strip can be bent, but not distorted, as shown below.

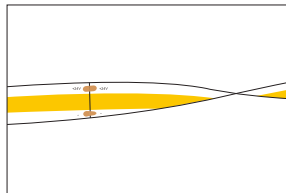
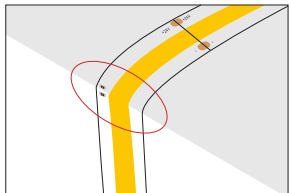
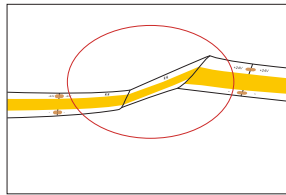
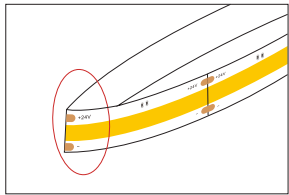

Distortion(Wrong)

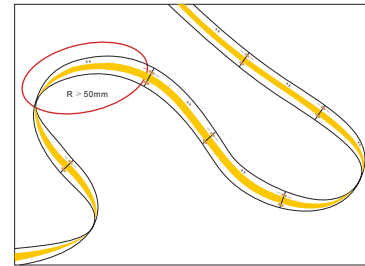

Bend(Right)

➤ This LED strip is low voltage version, you must use powersupply transformer. Please don't connect the led strip directly to AC110V or AC220V, otherwise it will burn out the LED strips.

➤ Clean up the installation surface, it will ensure the reliability of the adhesive, The electrical connection process must be operated by a professional person.

◆ Product packaging



Reel



Antistatic bag

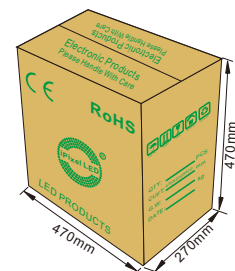

Note: The parameters are subject to change without notice!

A1.24-04-20

Mouser Electronics

Authorized Distributor

Click to View Pricing, Inventory, Delivery & Lifecycle Information:

[Adafruit:](#)

[5920](#)