

NANOCOMP Polymer Nanocomposite Force Sensing Material



Description

Medical Grade Polymer with Carbon-Based Nanoparticles. Homogeneously electrically conductive. When this polymer is compressed, the material's electrical conductivity changes. Using this material in combination with one of our SEN0001 to SEN0030 contact electrode boards (sold separately), the resistance of the material (which decreases as the material is compressed) can be measured using many different circuits, such as a voltage divider, buffered voltage divider, or a current to voltage converter.

Specifications

Shapes available:	Square, Round
Sizes available:	10x10mm, 15x15mm, 20x20mm
Thickness:	0.4mm
Maximum Force Capacity:	Up to 10kN/cm ² before sustaining physical damage, varies based on material size, shape and electrode structure.
Cutting:	Can be cut using plotters, scissors, knife, or cutting dies. Do not cut using laser or waterjet.
Chemical Stability:	Chemically stable.
Durability:	>500,000 loading cycles.
Operating Temperature Range:	-40°C to +200°C
Maximum Temperature Range:	-40°C to +250°C, for short duration during installation.

Recommended Circuit Wiring

In combination with a compatible SEN0001 to SEN0030 electrode board. Voltage divider: Electrode with force sensing material on it wired as the top resistor connected to Vcc (for example 3.3V or 5V), and the bottom resistor is a pull-down resistor of 10k ohms to 100k ohms. When the material is uncompressed, its resistance is in the megaohms range. When compressed, its resistance decreases exponentially to the kilohms range. The circuit node voltage between the resistors can be measured by any microcontroller, using a digital input for simple press detection, or with an analog input using an internal ADC to measure analog voltage and calculate resistance, and with calibration applied force.

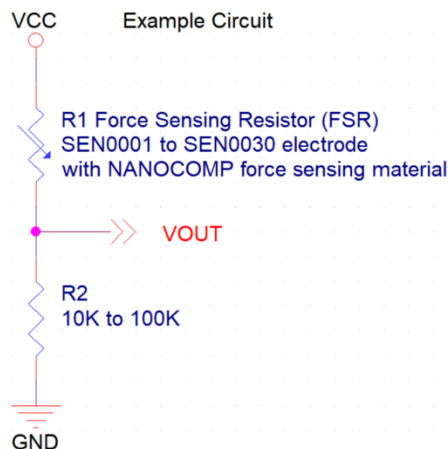

Force Sensing Resistor (FSR) resistance can be calculated as follows:

$$R1 = R2 (VCC / VOUT - 1)$$

Care and Cleaning

NANOCOMP force sensing material is flexible and washable.

NANOCOMP Polymer Nanocomposite Force Sensing Material Orderable Part Numbers

Part Number	Shape	Dimensions	Compatible SEN Electrode Board Part Numbers
NANOCOMP-SQR-10X10	Square	10x10x0.4mm	SEN0001, SEN0004, SEN0007, SEN0010, SEN0025
NANOCOMP-SQR-15X15	Square	15x15x0.4mm	SEN0002, SEN0005, SEN0008, SEN0011, SEN0026
NANOCOMP-SQR-20X20	Square	20x20x0.4mm	SEN0003, SEN0006, SEN0009, SEN0012, SEN0027
NANOCOMP-CRC-10X10	Round	10x10x0.4mm	SEN0013, SEN0016, SEN0019, SEN0022, SEN0028
NANOCOMP-CRC-15X15	Round	15x15x0.4mm	SEN0014, SEN0017, SEN0020, SEN0023, SEN0029
NANOCOMP-CRC-20X20	Round	20x20x0.4mm	SEN0015, SEN0018, SEN0021, SEN0024, SEN0030

SEN Force Sensing Resistor Electrode Orderable Part Numbers

Part Number	Electrode Trace/Space	Pad Shape	Pad Size	Solder Pad Direction	Compatible NANOCOMP Part Number
SEN0001	0.254mm, Tight	Square	10x10mm	Across (Compact)	NANOCOMP-SQR-10X10
SEN0002	0.254mm, Tight	Square	15x15mm	Across (Compact)	NANOCOMP-SQR-15X15
SEN0003	0.254mm, Tight	Square	20x20mm	Across (Compact)	NANOCOMP-SQR-20X20
SEN0004	0.254mm, Tight	Square	10x10mm	Long	NANOCOMP-SQR-10X10
SEN0005	0.254mm, Tight	Square	15x15mm	Long	NANOCOMP-SQR-15X15
SEN0006	0.254mm, Tight	Square	20x20mm	Long	NANOCOMP-SQR-20X20
SEN0007	0.508mm, Wide	Square	10x10mm	Across (Compact)	NANOCOMP-SQR-10X10
SEN0008	0.508mm, Wide	Square	15x15mm	Across (Compact)	NANOCOMP-SQR-15X15
SEN0009	0.508mm, Wide	Square	20x20mm	Across (Compact)	NANOCOMP-SQR-20X20
SEN0010	0.508mm, Wide	Square	10x10mm	Long	NANOCOMP-SQR-10X10
SEN0011	0.508mm, Wide	Square	15x15mm	Long	NANOCOMP-SQR-15X15
SEN0012	0.508mm, Wide	Square	20x20mm	Long	NANOCOMP-SQR-20X20
SEN0013	0.254mm, Tight	Round	10x10mm	Across (Compact)	NANOCOMP-CRC-10X10
SEN0014	0.254mm, Tight	Round	15x15mm	Across (Compact)	NANOCOMP-CRC-15X15
SEN0015	0.254mm, Tight	Round	20x20mm	Across (Compact)	NANOCOMP-CRC-20X20
SEN0016	0.254mm, Tight	Round	10x10mm	Long	NANOCOMP-CRC-10X10
SEN0017	0.254mm, Tight	Round	15x15mm	Long	NANOCOMP-CRC-15X15
SEN0018	0.254mm, Tight	Round	20x20mm	Long	NANOCOMP-CRC-20X20
SEN0019	0.508mm, Wide	Round	10x10mm	Across (Compact)	NANOCOMP-CRC-10X10
SEN0020	0.508mm, Wide	Round	15x15mm	Across (Compact)	NANOCOMP-CRC-15X15
SEN0021	0.508mm, Wide	Round	20x20mm	Across (Compact)	NANOCOMP-CRC-20X20
SEN0022	0.508mm, Wide	Round	10x10mm	Long	NANOCOMP-CRC-10X10
SEN0023	0.508mm, Wide	Round	15x15mm	Long	NANOCOMP-CRC-15X15
SEN0024	0.508mm, Wide	Round	20x20mm	Long	NANOCOMP-CRC-20X20
SEN0025	Full Pad, fold over flex PCB	Square	10x10mm	Long	NANOCOMP-SQR-10X10
SEN0026	Full Pad, fold over flex PCB	Square	15x15mm	Long	NANOCOMP-SQR-15X15
SEN0027	Full Pad, fold over flex PCB	Square	20x20mm	Long	NANOCOMP-SQR-20X20
SEN0028	Full Pad, fold over flex PCB	Round	10x10mm	Long	NANOCOMP-CRC-10X10
SEN0029	Full Pad, fold over flex PCB	Round	15x15mm	Long	NANOCOMP-CRC-15X15
SEN0030	Full Pad, fold over flex PCB	Round	20x20mm	Long	NANOCOMP-CRC-20X20

Photos / What's Included

Each NANOCOMP part number includes 1x NANOCOMP force sensitive polymer sheet.

Some photos show the force sensitive material with a SEN electrode flex PCB for illustrative purposes only, not included, sold separately.

NANOCOMP Polymer Nanocomposite Force Sensing Product Photos

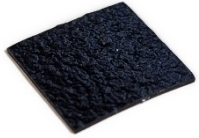

NANOCOMP-SQR-10X10 top

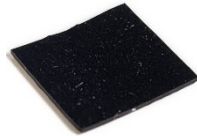

NANOCOMP-SQR-10X10 bottom

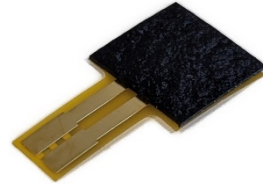

SEN0010 with NANOCOMP-SQR-10X10 material



NANOCOMP-SQR-15X15 top



NANOCOMP-SQR-15X15 bottom

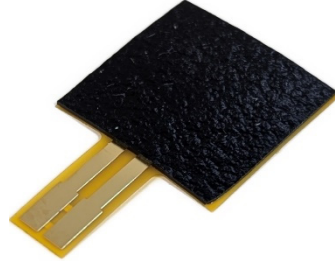

SEN0011 with NANOCOMP-SQR-15X15 material

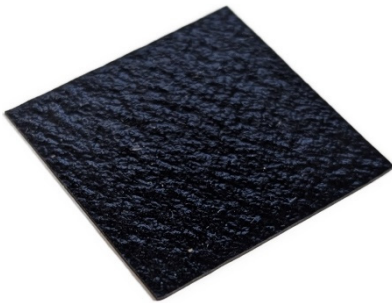

NANOCOMP-SQR-20X20 top

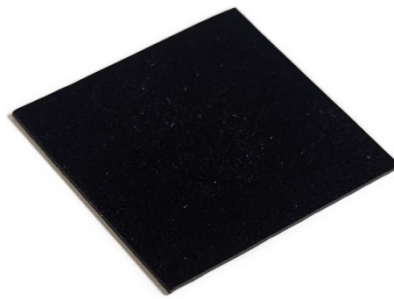

NANOCOMP-SQR-20X20 bottom

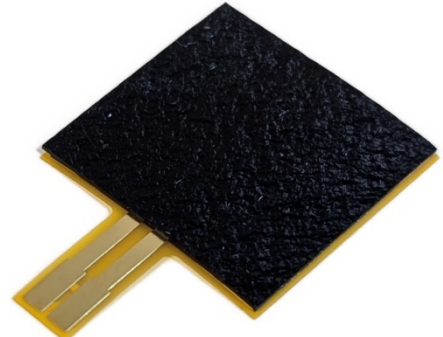

SEN0012 with NANOCOMP-SQR-20X20 material



NANOCOMP-CRC-10X10 top



NANOCOMP-CRC-10X10 bottom



SEN0022 with NANOCOMP-CRC-10X10 material



NANOCOMP-CRC-15X15 top



NANOCOMP-CRC-15X15 bottom



SEN0023 with NANOCOMP-CRC-15X15 material



NANOCOMP-CRC-20X20 top

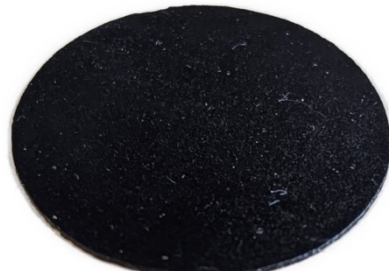

NANOCOMP-CRC-20X20 bottom



SEN0024 with NANOCOMP-CRC-20X20 material

SEN0001 to SEN0030 Force Sensing Resistor Electrode Series: SEN0001-SEN0006 Photos



SEN0001 top



SEN0001 bottom

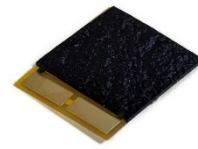

SEN0001 with NANOCOMP-SQR-10X10 material

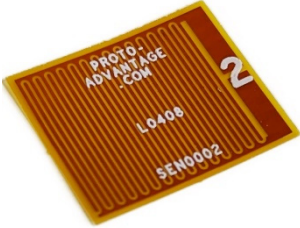

SEN0002 top



SEN0002 bottom

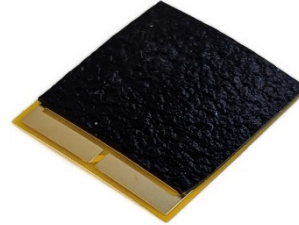

SEN0002 with NANOCOMP-SQR-15X15 material

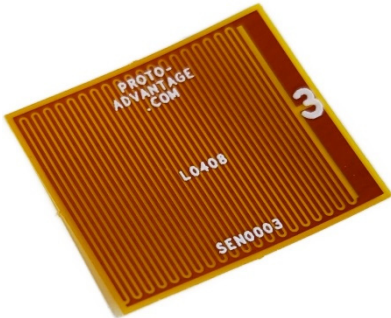

SEN0003 top

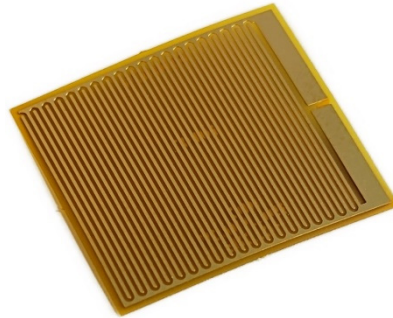

SEN0003 bottom

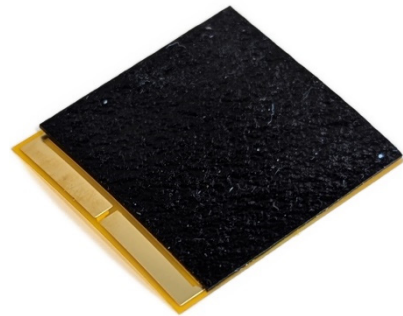

SEN0003 with NANOCOMP-SQR-20X20 material



SEN0004 top

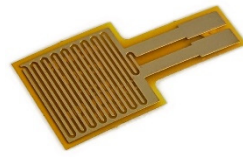

SEN0004 bottom

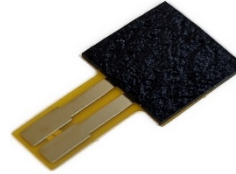

SEN0004 with NANOCOMP-SQR-10X10 material

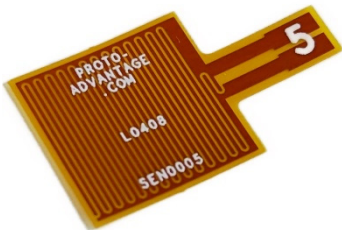

SEN0005 top

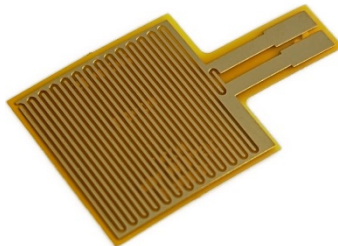

SEN0005 bottom

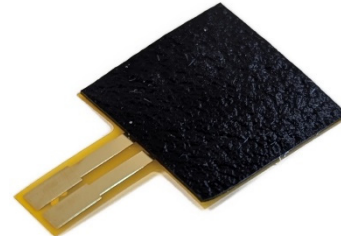

SEN0005 with NANOCOMP-SQR-15X15 material

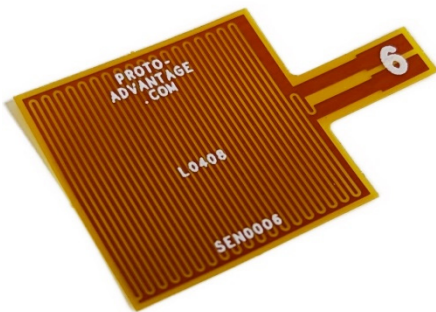

SEN0006 top

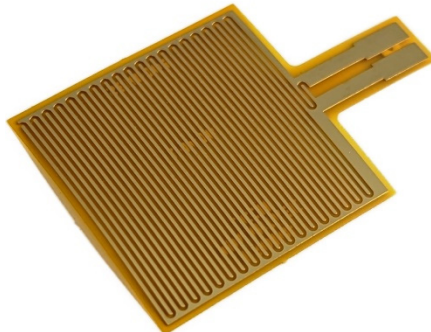

SEN0006 bottom

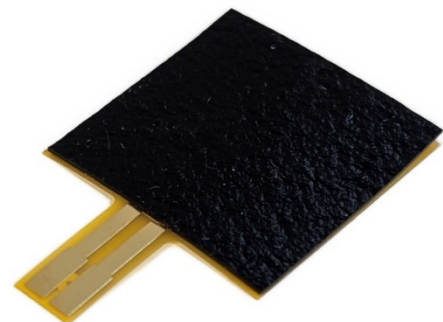

SEN0006 with NANOCOMP-SQR-20X20 material

SEN0001 to SEN0030 Force Sensing Resistor Electrode Series: SEN0007-SEN0012 Photos



SEN0007 top



SEN0007 bottom

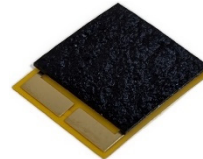

SEN0007 with NANOCOMP-SQR-10X10 material

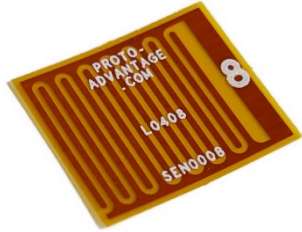

SEN0008 top

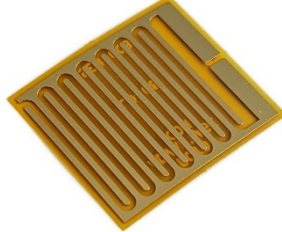

SEN0008 bottom

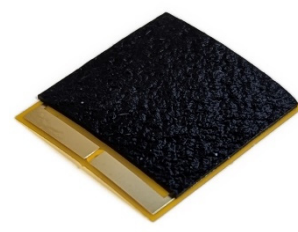

SEN0008 with NANOCOMP-SQR-15X15 material

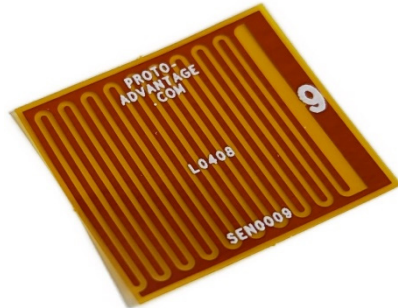

SEN0009 top

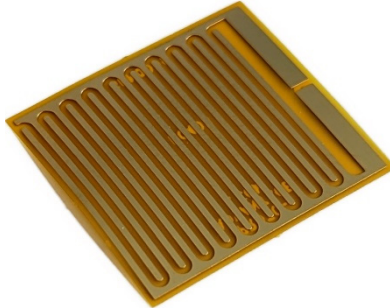

SEN0009 bottom

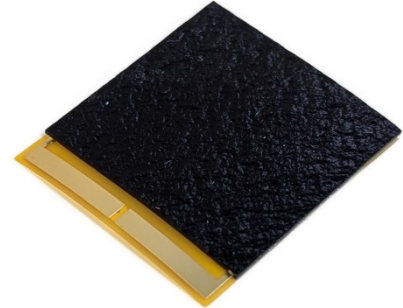

SEN0009 with NANOCOMP-SQR-20X20 material

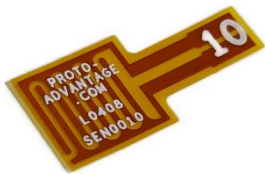

SEN0010 top



SEN0010 bottom

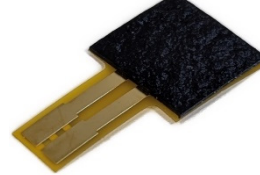

SEN0010 with NANOCOMP-SQR-10X10 material

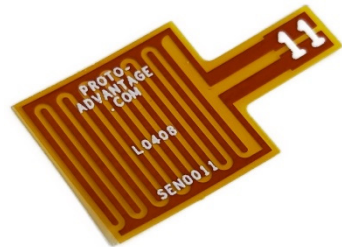

SEN0011 top

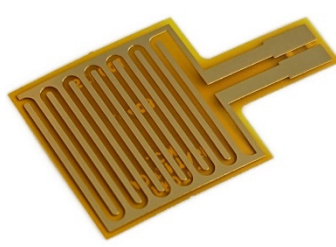

SEN0011 bottom

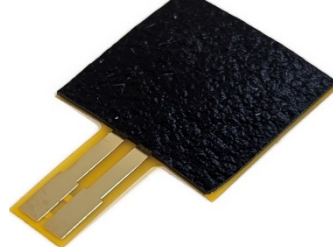

SEN0011 with NANOCOMP-SQR-15X15 material

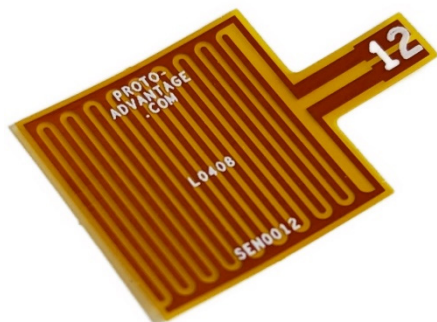

SEN0012 top

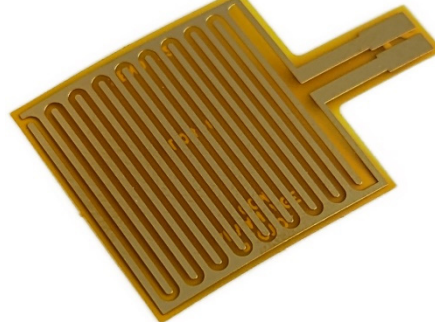

SEN0012 bottom

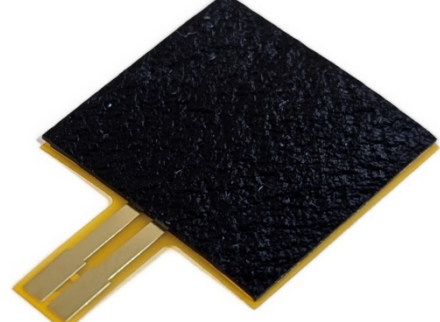

SEN0012 with NANOCOMP-SQR-20X20 material

SEN0001 to SEN0030 Force Sensing Resistor Electrode Series: SEN0013-SEN0018 Photos



SEN0013 top



SEN0013 bottom

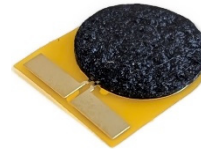

SEN0013 with NANOCOMP-CRC-10X10 material



SEN0014 top



SEN0014 bottom

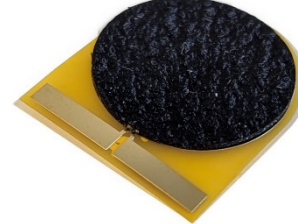

SEN0014 with NANOCOMP-CRC-15X15 material



SEN0015 top



SEN0015 bottom

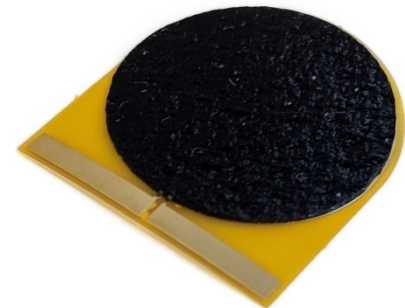

SEN0015 with NANOCOMP-CRC-20X20 material



SEN0016 top



SEN0016 bottom



SEN0016 with NANOCOMP-CRC-10X10 material



SEN0017 top



SEN0017 bottom



SEN0017 with NANOCOMP-CRC-15X15 material

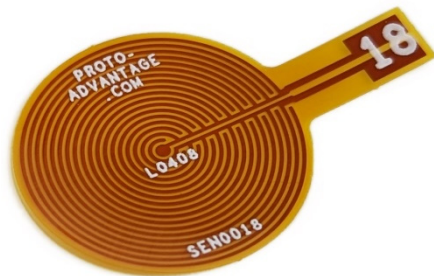

SEN0018 top



SEN0018 bottom



SEN0018 with NANOCOMP-CRC-20X20 material

SEN0001 to SEN0030 Force Sensing Resistor Electrode Series: SEN0019-SEN0024 Photos



SEN0019 top



SEN0019 bottom

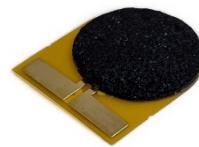

SEN0019 with NANOCOMP-CRC-10X10 material



SEN0020 top



SEN0020 bottom

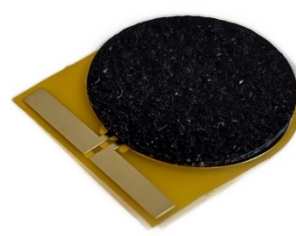

SEN0020 with NANOCOMP-CRC-15X15 material



SEN0021 top



SEN0021 bottom



SEN0021 with NANOCOMP-CRC-20X20 material



SEN0022 top



SEN0022 bottom



SEN0022 with NANOCOMP-CRC-10X10 material



SEN0023 top



SEN0023 bottom



SEN0023 with NANOCOMP-CRC-15X15 material



SEN0024 top



SEN0024 bottom



SEN0024 with NANOCOMP-CRC-20X20 material

SEN0001 to SEN0030 Force Sensing Resistor Electrode Series: SEN0025-SEN0030 Photos



SEN0025 top

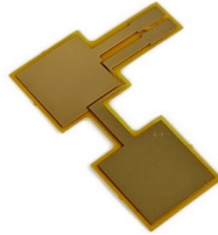

SEN0025 bottom

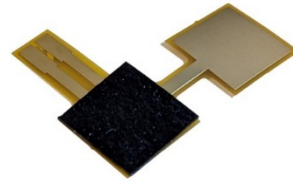

SEN0025 with NANOCOMP-SQR-10X10 material

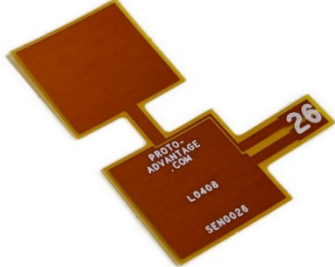

SEN0026 top

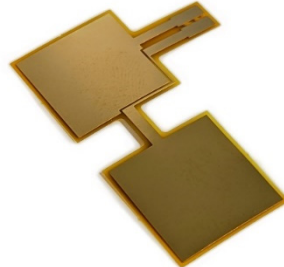

SEN0026 bottom

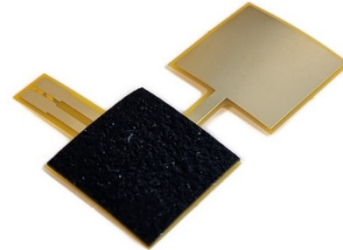

SEN0026 with NANOCOMP-SQR-15X15 material

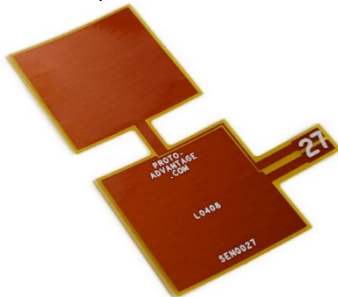

SEN0027 top



SEN0027 bottom

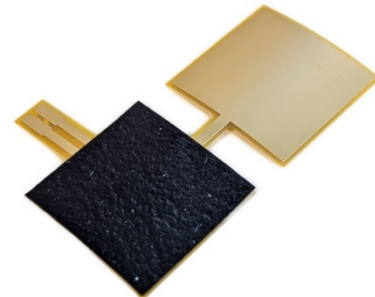

SEN0027 with NANOCOMP-SQR-20X20 material



SEN0028 top



SEN0028 bottom



SEN0028 with NANOCOMP-CRC-10X10 material

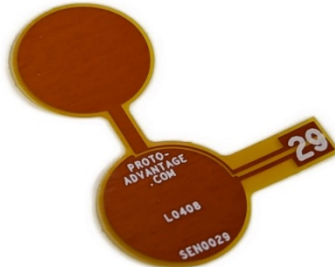

SEN0029 top



SEN0029 bottom



SEN0029 with NANOCOMP-CRC-15X15 material

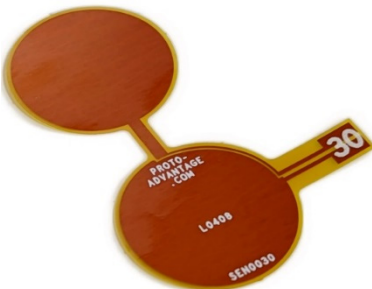

SEN0030 top



SEN0030 bottom



SEN0030 with NANOCOMP-CRC-20X20 material

Mouser Electronics

Authorized Distributor

Click to View Pricing, Inventory, Delivery & Lifecycle Information:

[Chip Quik:](#)

[NANOCOMP-SQR-15X15](#)