

J Series® 3030 Photophyll™ Select LEDs

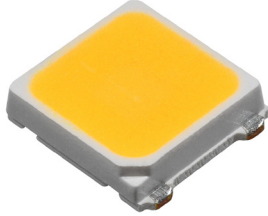

PRODUCT DESCRIPTION

Photophyll™ Select LEDs feature an advanced horticulture spectrum with blue and green output tuned for horticulture applications. Photophyll Select LEDs are designed to replace the white LEDs that are common in two-channel white + red horticulture luminaires. By maximizing green content and minimizing red content versus standard lighting LEDs, this LED color enables significant enhancements to luminaire cost and performance.

Photophyll Select LEDs are the industry's first LEDs to be entirely binned in horticulture metrics, enabling more straightforward spectrum design without confusing translations or conversions. The spectral output of these LEDs is binned into two metrics, both of which are based on the amount of PPF in standard blue (400-500 nm), green (500-600 nm) and red (600-700 nm) bands. The two spectral metrics are the percentage of red PPF content (Red PPF%) and the ratio of green to blue PPF content (Green/Blue Ratio or GBR).

J Series® JB3030C 3-V E Class Photophyll Select LEDs combine this new color with the industry's highest efficacy 3030 platform to achieve breakthrough system-level performance.

FEATURES

- Industry-compatible size : 3.0 x 3.0 x 0.75 mm
- 3-V configuration
- RoHS and REACH compliant
- UL® recognized component (E495478)



J Series® Products are sold exclusively by Cree Venture LED Company Limited ("Cree Venture"), regardless of geography. Any orders for J Series Products that are submitted to Cree LED or any of its other subsidiaries will be directed to Cree Venture for acknowledgment and order fulfillment.

Cree LED / 4001 E. Hwy. 54, Suite 2000 / Durham, NC 27709 USA / +1.919.313.5330 / www.cree-led.com

TABLE OF CONTENTS

Order Code & Bin Code Formats	3
Characteristics	4
Operating Limits.....	4
Order Codes.....	5
Relative PPF vs. Current	6
Electrical Characteristics.....	6
Relative PPF vs. Junction Temperature.....	7
Relative Spectral Power Distribution	7
Typical Spatial Distribution.....	8
Performance Groups - Forward Voltage.....	9
Reflow Soldering Characteristics.....	10
Notes	11
Mechanical Dimensions	13
Tape & Reel.....	15
Packaging.....	16

ORDER CODE & BIN CODE FORMATS

Order codes and bin codes for J Series 3030 Photophyll Select LEDs are configured in the following manner:

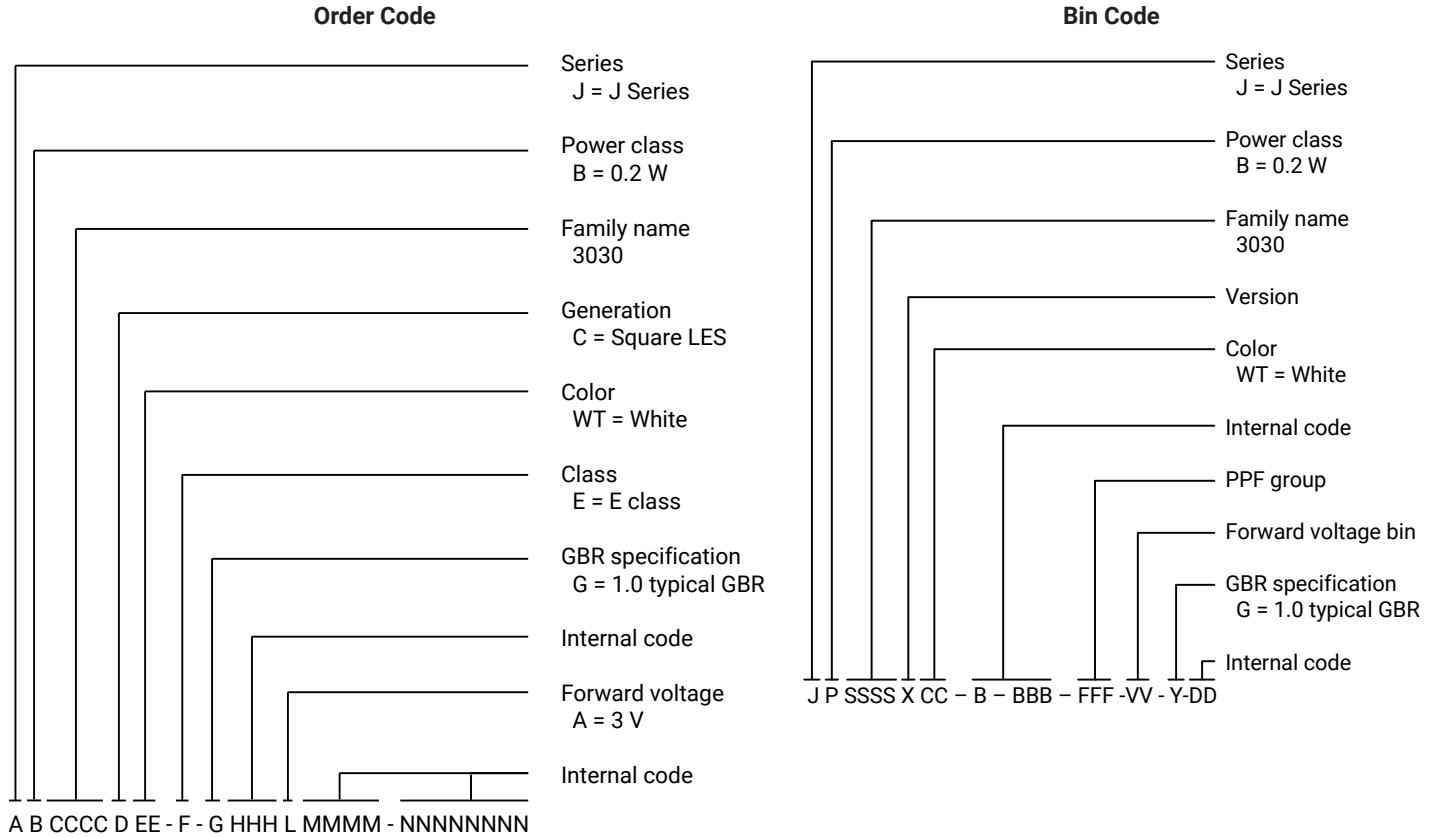

CHARACTERISTICS

Characteristics	Unit	Minimum	Typical	Maximum
Thermal resistance, junction to solder point	°C/W		4	
Viewing angle (FWHM)	degrees		116	
Temperature coefficient of voltage	mV/°C		-1.2	
ESD withstand voltage (HBM per MIL-STD-883L)			Class 3B	
DC forward current	mA			240
Reverse voltage	V			5
Forward voltage (@ 55 mA, 25 °C)	V		2.66	2.8
LED junction temperature	°C			125
Operating temperature	°C	-40		105

Notes

- ◇ Thermal resistance measurement was performed per the JEDEC JESD51-14 standard. See the [Thermal Resistance Measurement application note](#) for more details.
- Continuous reverse voltage can cause LED damage.

OPERATING LIMITS

The maximum forward current is determined by the thermal resistance between the LED junction and ambient.

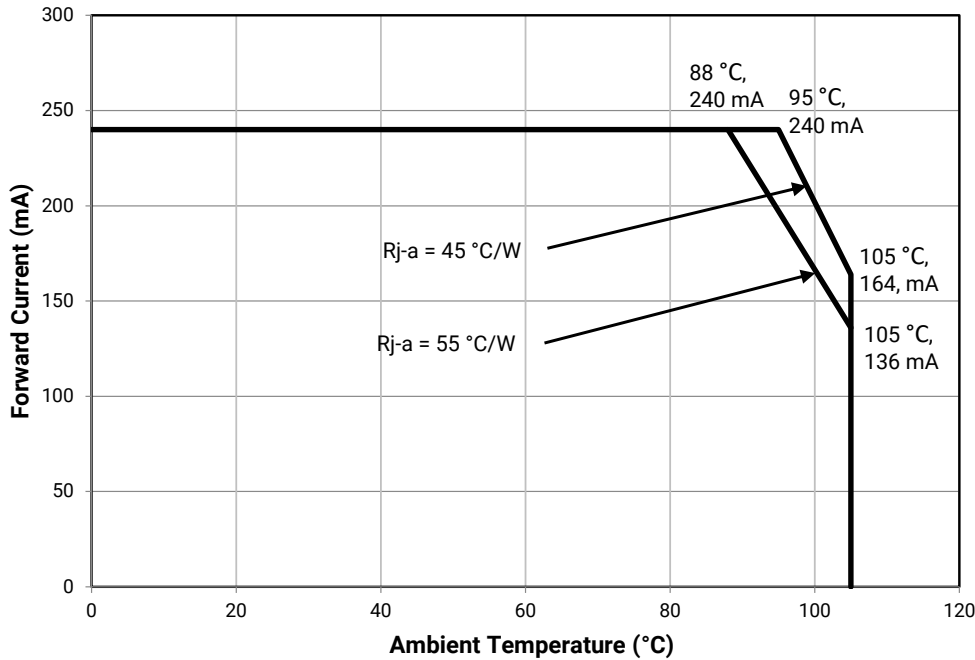

ORDER CODES ($I_f = 55 \text{ mA}$, $T_j = 25 \text{ °C}$)

The following table provides order codes for J Series JB3030C 3-V E Class Photophyll Select LEDs. For a complete description of the order code nomenclature, please see the Order Code and Bin Code Formats section (page 3).

Color	Red PPF %	Green/Blue Ratio (GBR)	GBR Code	PPF ($\mu\text{mol/s}$)		Calculated PPE ($\mu\text{mol/J}$)		Order Code
				Minimum	Typical	Minimum	Typical	
Photophyll Select	10%	1.0	G	0.41	0.44	2.80	3.00	JB3030CWT-E-G001A0000-NZ000001

Notes:

- Red PPF % is calculated as the ratio of Red photon flux (600-700 nm) to total PPF (400-700 nm). Tolerance for Red PPF % is $\pm 2.5\%$.
- GBR: Green/Blue Ratio is calculated as the ratio of Green photon flux (500-600 nm) to Blue photon flux (400-500 nm). Tolerance for GBR is ± 0.5 .
- PPF is a photon flux measurement in the 400-700 nm range
- PPE values are calculated and for reference only.
- Cree Venture maintains a tolerance of $\pm 7\%$ on PPF measurements. See the Measurements section (page 11).

RELATIVE PPF VS. CURRENT

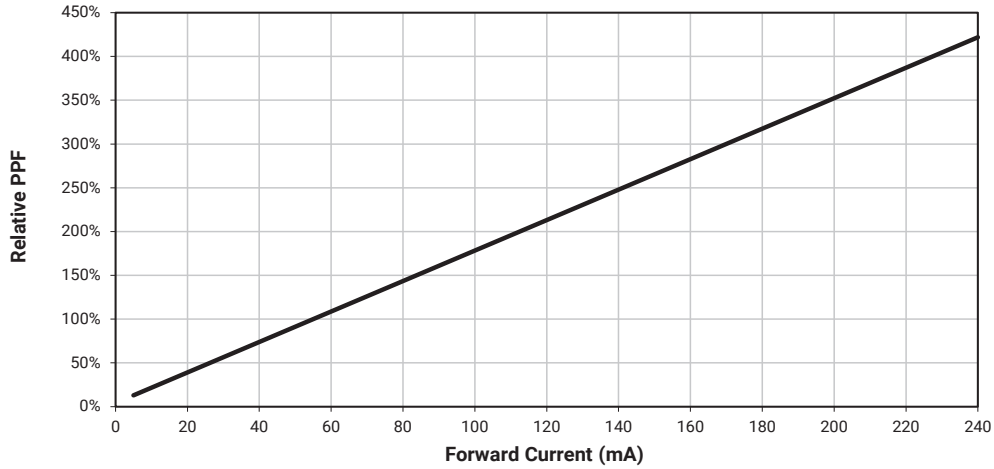

ELECTRICAL CHARACTERISTICS

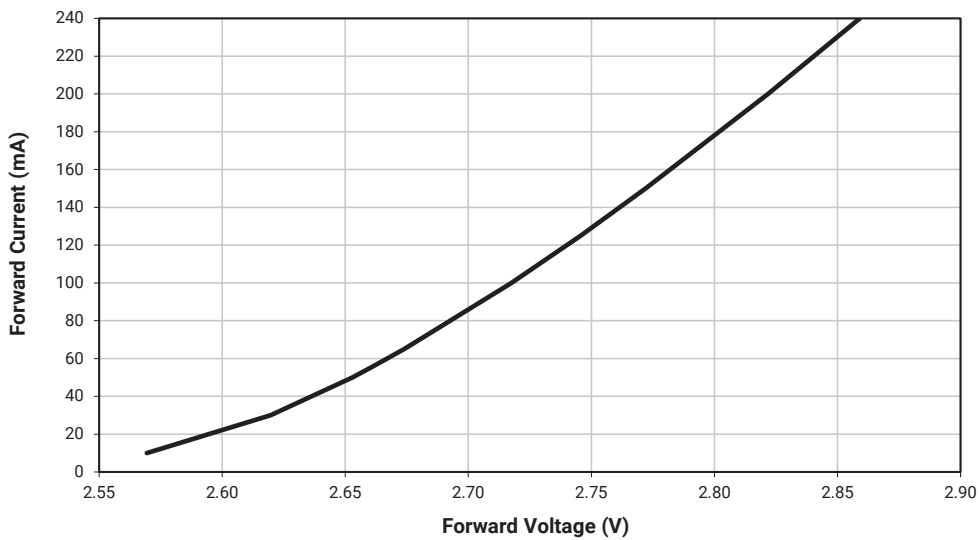

RELATIVE PPF VS. JUNCTION TEMPERATURE

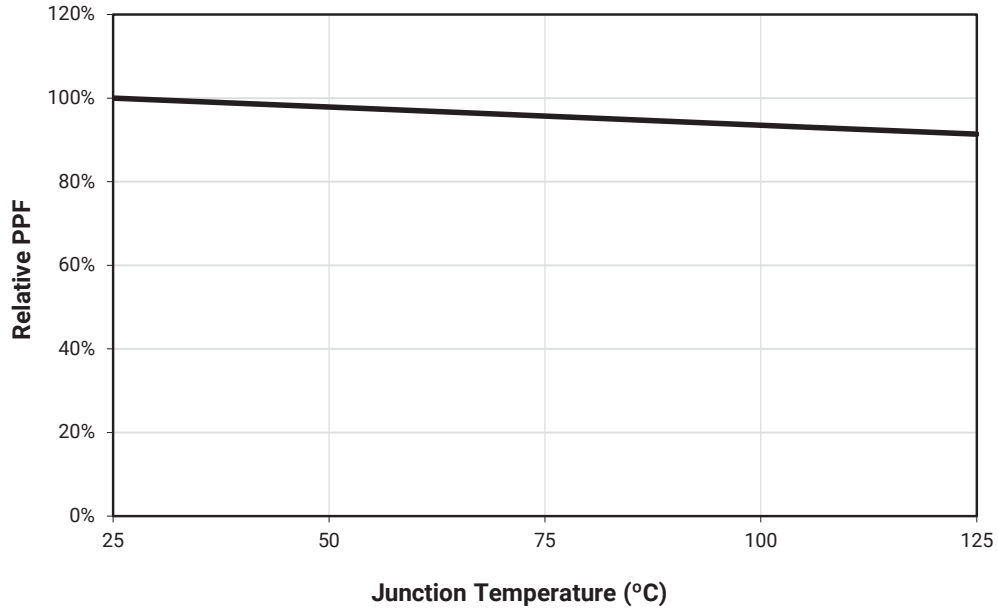

RELATIVE SPECTRAL POWER DISTRIBUTION

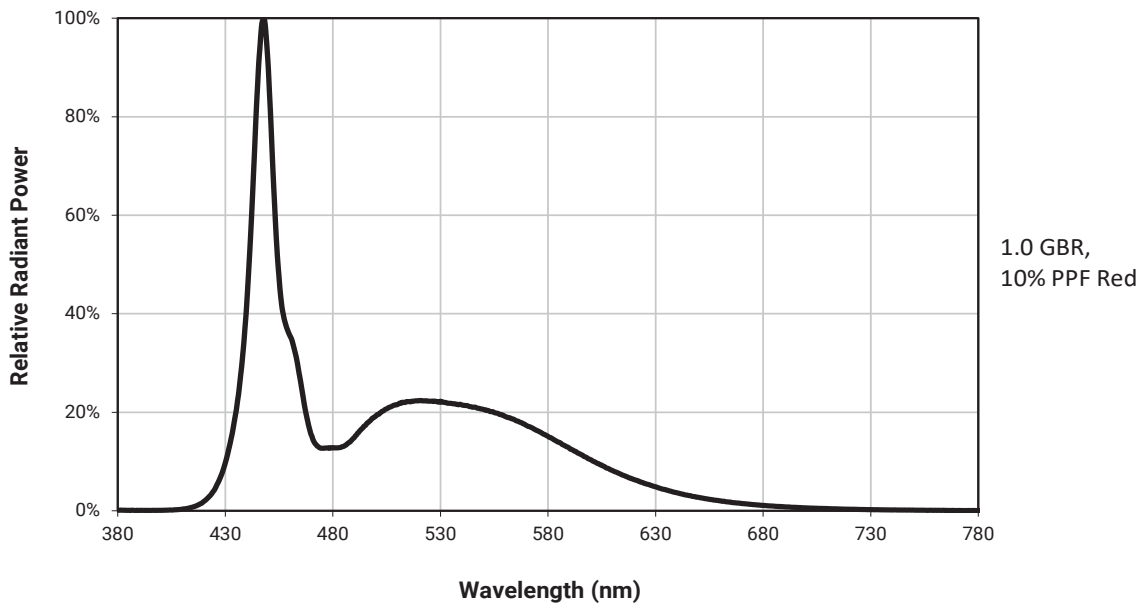

TYPICAL SPATIAL DISTRIBUTION

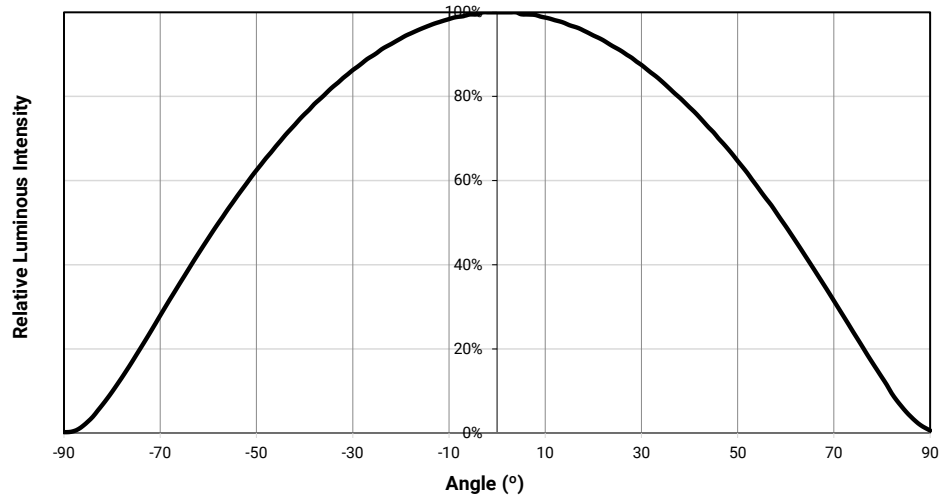

PERFORMANCE GROUPS - FORWARD VOLTAGE ($T_j = 25\text{ °C}$)

J Series 3030 Photophyll Select LEDs are tested for forward voltage and placed into one of the following voltage bins.

The following voltage bins are indicated in the Forward Voltage Bin field in the bin code for JB3030C 3-V E Class Photophyll Select LEDs.

Voltage Bin	Minimum Forward Voltage (V)	Minimum Forward Voltage (V)
AC	2.6	2.7
AD	2.7	2.8

REFLOW SOLDERING CHARACTERISTICS

In testing, Cree Venture has found J Series JB3030C 3-V E Class Photophyll Select LEDs to be compatible with JEDEC J-STD-020C, using the parameters listed below. As a general guideline, Cree Venture recommends that users follow the recommended soldering profile provided by the manufacturer of the solder paste used, and therefore it is the lamp or luminaire manufacturer’s responsibility to determine applicable soldering requirements.

Note that this general guideline may not apply to all PCB designs and configurations of reflow soldering equipment.

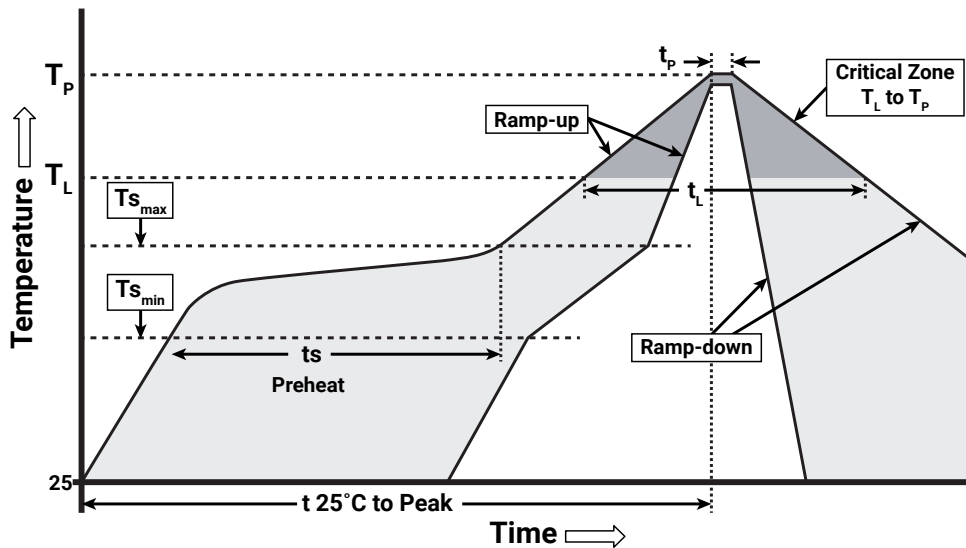

IPC/JEDEC J-STD-020C

Profile Feature	Lead-Free Solder
Average Ramp-Up Rate ($T_{s_{max}}$ to T_P)	1.2 °C/second
Preheat: Temperature Min ($T_{s_{min}}$)	120 °C
Preheat: Temperature Max ($T_{s_{max}}$)	170 °C
Preheat: Time ($t_{s_{min}}$ to $t_{s_{max}}$)	65-150 seconds
Time Maintained Above: Temperature (T_L)	217 °C
Time Maintained Above: Time (t_L)	45-90 seconds
Peak/Classification Temperature (T_P)	235 - 245 °C
Time Within 5 °C of Actual Peak Temperature (t_p)	20-40 seconds
Ramp-Down Rate	1 - 6 °C/second
Time 25 °C to Peak Temperature	4 minutes max.

Note: All temperatures refer to the topside of the package, measured on the package body surface.

NOTES

Measurements

The PPF, GBR and Red PPF % measurements in this document are binning specifications only and solely represent product measurements as of the date of shipment. These measurements will change over time based on a number of factors that are not within Cree Venture's control and are not intended or provided as operational specifications for the products. Calculated values are provided for informational purposes only and are not intended or provided as specifications.

Pre-Release Qualification Testing

Please read the [J Series Reliability Overview](#) for the details of the pre-release qualification testing for J Series LEDs.

Photon Flux Maintenance

Cree Venture uses standardized IES LM-80-08 and TM-21-11 methods for collecting long-term data and extrapolating LED photon flux maintenance. For information on the specific LM-80 data sets available for this LED, refer to the public [J Series LM-80 results document](#).

Please read the [Thermal Management application note](#) for details on how thermal design, ambient temperature, and drive current affect the LED junction temperature.

Moisture Sensitivity

Cree Venture recommends keeping J Series 3030 Photophyll Select LEDs in the provided, resealable moisture-barrier packaging (MBP) until immediately prior to soldering. Unopened MBP that contains J Series 3030 Photophyll Select LEDs does not need special storage for moisture sensitivity.

Once the MBP is opened, J Series 3030 Photophyll Select LEDs should be handled and stored as MSL 3 per JEDEC J-STD-033, meaning they have limited exposure time before damage to the LED may occur during the soldering operation. The table on the right specifies the maximum exposure time in days depending on temperature and humidity conditions. LEDs with exposure time longer than the specified maximums must be baked according to the baking conditions listed below.

Moisture Sensitivity Level	Temp.	Maximum Percent Relative Humidity				
		50%	60%	70%	80%	90%
Level 3	35 °C	8	5	1	0.5	0.5
Level 3	30 °C	11	7	1	1	1
Level 3	25 °C	14	10	2	1	1
Level 3	20 °C	20	13	2	1	1

Baking Conditions

It is not necessary to bake all J Series 3030 Photophyll Select LEDs. Only the LEDs that meet all of the following criteria must be baked:

1. LEDs that have been removed from the original MBP.
2. LEDs that have been exposed to a humid environment longer than listed in the Moisture Sensitivity section above.
3. LEDs that have not been soldered.

LEDs should be baked at 60 °C for 24 hours. LEDs may be baked in the original reels. Remove LEDs from the MBP before baking. Do not bake parts at temperatures higher than 60 °C. This baking operation resets the exposure time as defined in the Moisture Sensitivity section above.

NOTES - CONTINUED

RoHS Compliance

The levels of RoHS restricted materials in this product are below the maximum concentration values (also referred to as the threshold limits) permitted for such substances, or are used in an exempted application, in accordance with EU Directive 2011/65/EC (RoHS2), as implemented January 2, 2013. RoHS Declarations for this product can be obtained from your Cree Venture representative or from the [Product Ecology](#) section of the Cree LED website.

REACH Compliance

REACH substances of very high concern (SVHCs) information is available for this product. Since the European Chemical Agency (ECHA) has published notice of their intent to frequently revise the SVHC listing for the foreseeable future, please contact a Cree representative to insure you get the most up-to-date REACH SVHC Declaration. REACH banned substance information (REACH Article 67) is also available upon request.

UL® Recognized Component

This product meets the requirements to be considered a UL Recognized Component with Level 4 enclosure consideration. The LED package or a portion thereof has been investigated as a fire and electrical enclosure per ANSI/UL 8750.

Vision Advisory

WARNING: Do not look at an exposed lamp in operation. Eye injury can result. For more information about LEDs and eye safety, please refer to the [J Series LED Eye Safety application note](#).

MECHANICAL DIMENSIONS

Vias, if present, are not shown on these drawings.

All measurements are ± 0.1 mm unless otherwise indicated.

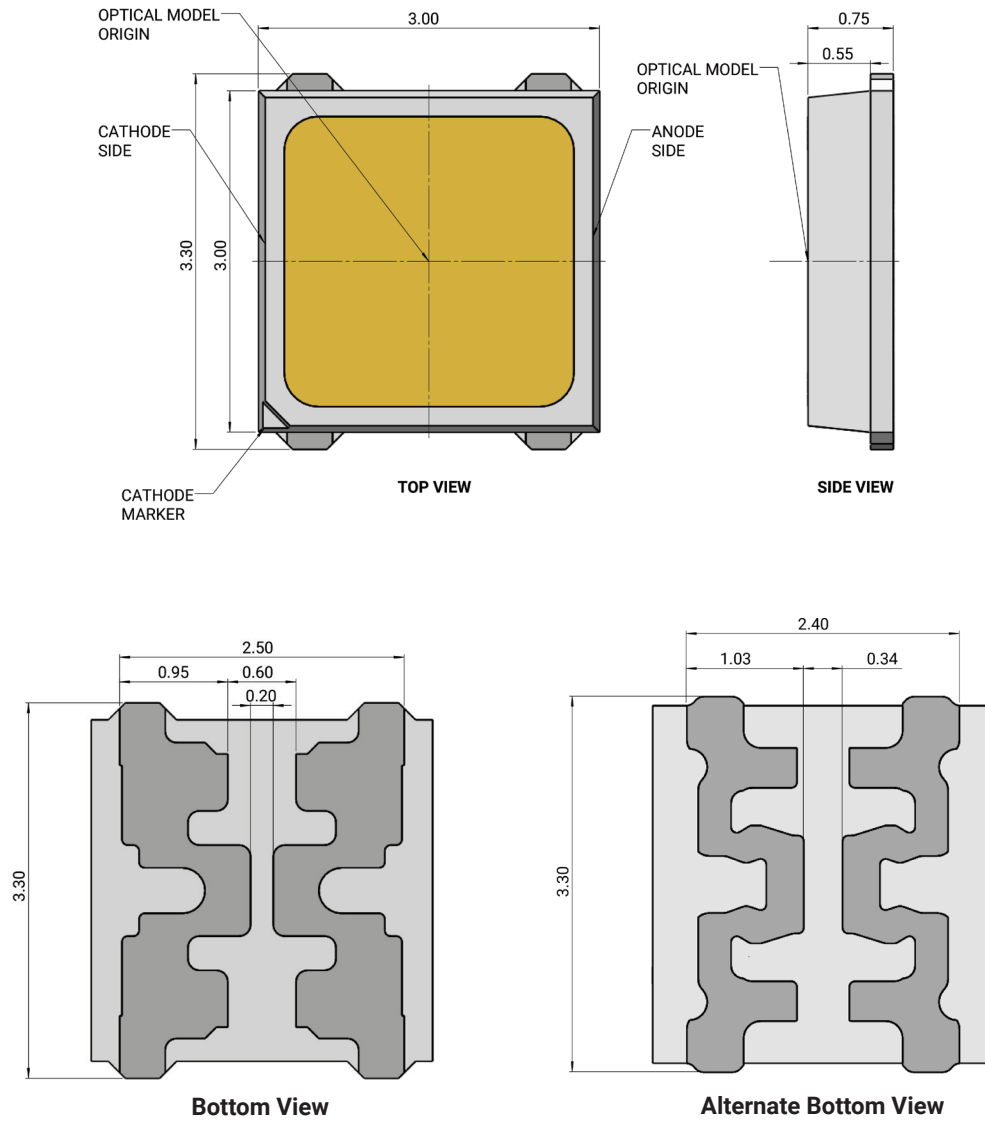

MECHANICAL DIMENSIONS - CONTINUED

Vias, if present, are not shown on these drawings.

All measurements are ± 0.1 mm unless otherwise indicated.

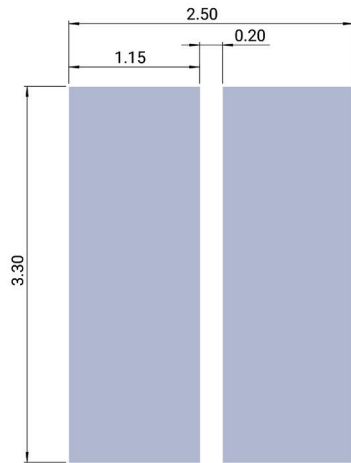

Recommended PCB Footprint

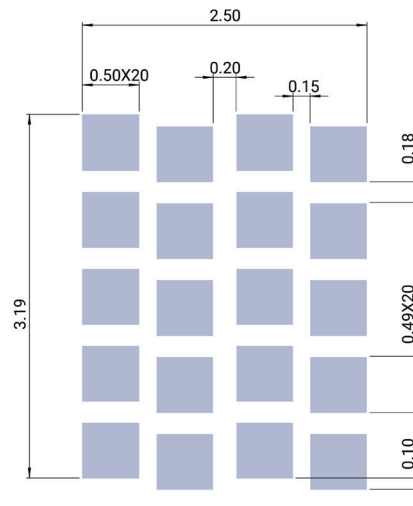

**Recommended Stencil Pattern
(Shaded Area Is Open)**

TAPE & REEL

All Cree Venture carrier tapes conform to EIA-481D, Automated Component Handling Systems Standard.

All dimensions in mm.

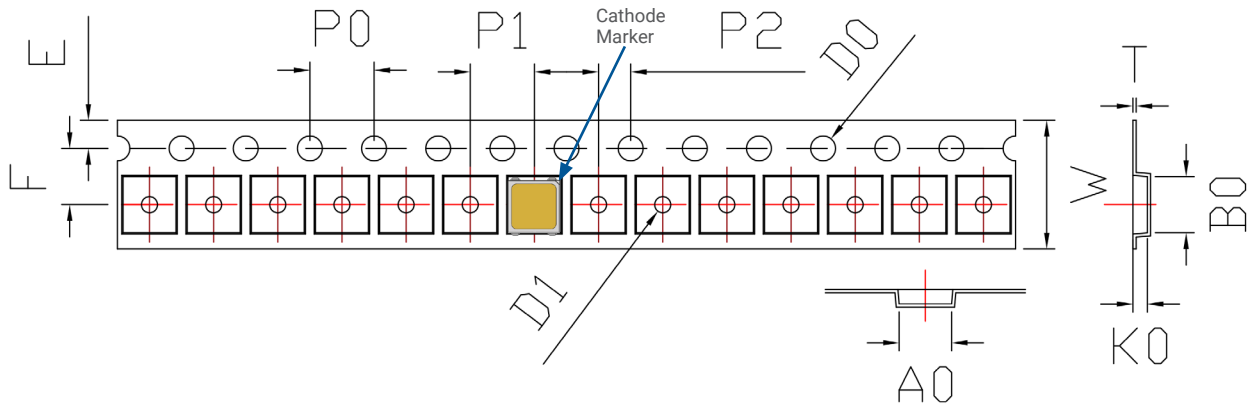

Item	A0	B0	K0	P0	P1	P2	T	E	F	D0	D1	W
Dim.	3.30±0.10	3.60±0.10	1.00±0.10	4.00±0.10	4.0±0.10	2.0±0.10	0.25±0.05	1.75±0.10	5.5±0.05	1.50+0.1 -0	1.50±0.10	12.0±0.2

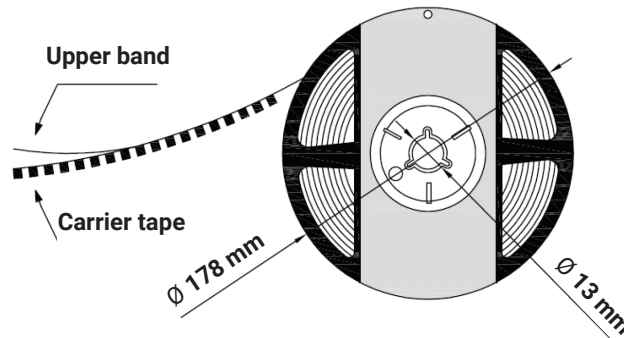
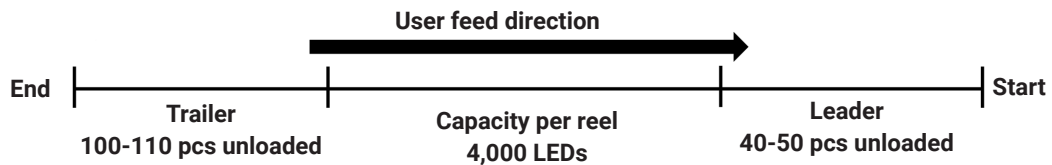

PACKAGING

Unpackaged Reel

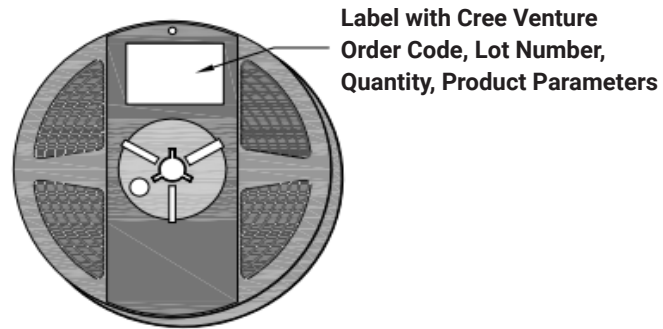

Packaged Reel

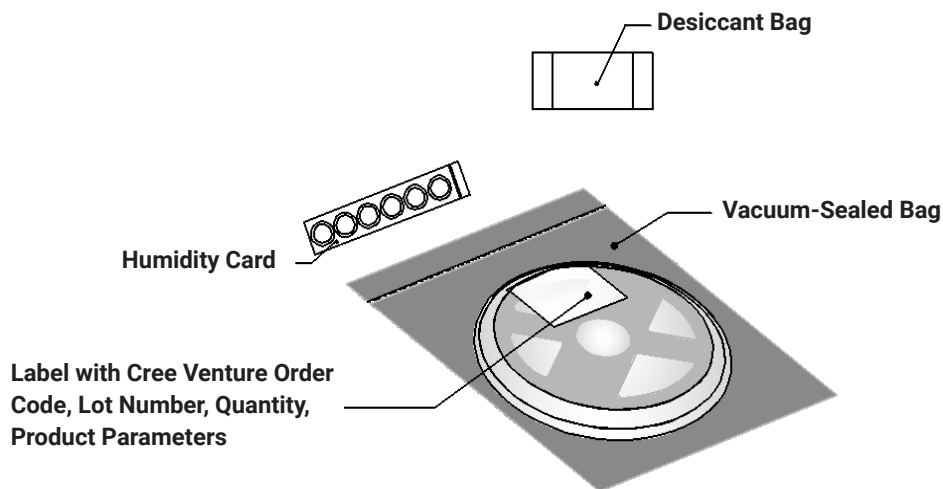

PACKAGING - CONTINUED

J Series 3030 Photophyll Select LEDs are packaged in boxes for shipment. Box sizes and the number of reels per box are as follows.

Box	Box Dimensions	Maximum Number of Reels per Box
1	250 x 210 x 30 mm	2
2	250 x 210 x 50 mm	4
3	530 x 230 x 275 mm	44
4	530 x 443 x 275 mm	88

Each box has at least one label (shown as a white square in the diagrams below) showing the order code, lot number, quantity, and product parameters.

Box 1

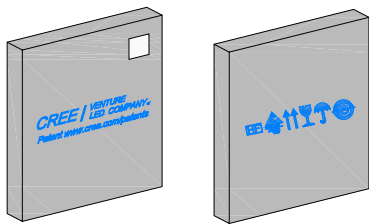

Box 2

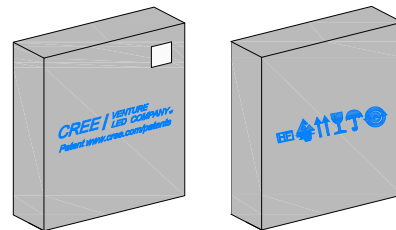

Box 3

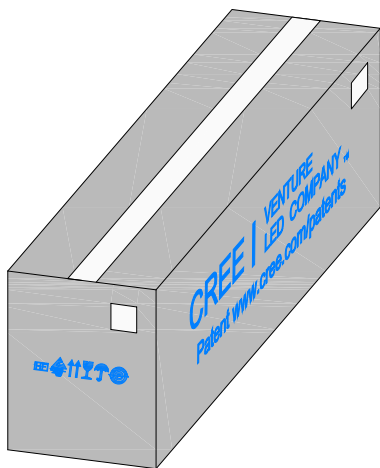

Box 4

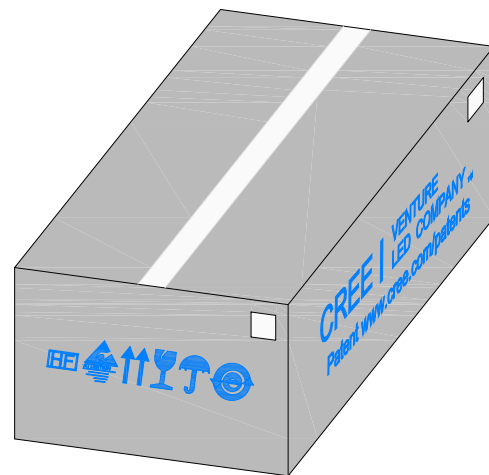

Mouser Electronics

Authorized Distributor

Click to View Pricing, Inventory, Delivery & Lifecycle Information:

[Cree LED:](#)

[JB3030CWT-E-G001A0000-N0000001](#)