

**100-V-Übertrager** für Lautsprecher in ELA-Anlagen.  
**100 V transformer** for loudspeakers in PA systems.

**TR 10.16**  
Art. No. 1803

Technische Daten / Specifications:

Primär / Primary:	10 W -	1 kOhm
	5 W -	2 kOhm
	2,5 W -	4 kOhm
	1,25 W -	8 kOhm
	0,625 W -	16 kOhm

Sekundär / Secondary: 4; 8; 16 Ohm

Frequenzbereich/

Frequency Range: 50–19000 Hz (–3 dB)

Gewicht netto / Net weight: 0,285 kg

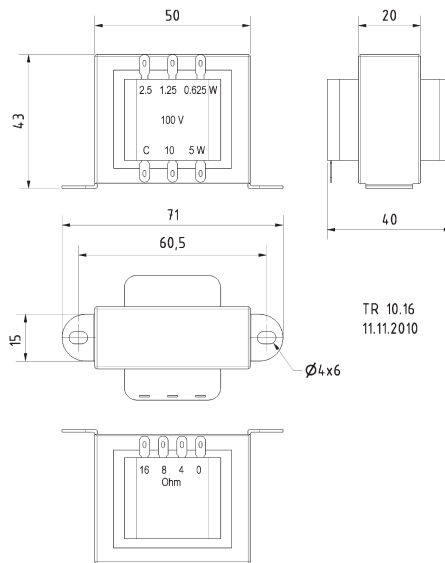

TR 10.16  
11.11.2010

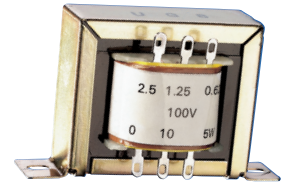

**100-V-Übertrager** für Lautsprecher in ELA-Anlagen.  
**100 V transformer** for loudspeakers in PA systems.

**TR 84**  
Art. No. 1801

Technische Daten / Specifications:

Primär/Primary:	10 W -	1,0 kOhm
	6 W -	1,7 kOhm
	3 W -	3,3 kOhm

Sekundär / Secondary: 4; 8 Ohm

Frequenzbereich/

Frequency Range: 20–20000 Hz (–3 dB)

Gewicht netto / Net weight: 0,32 kg

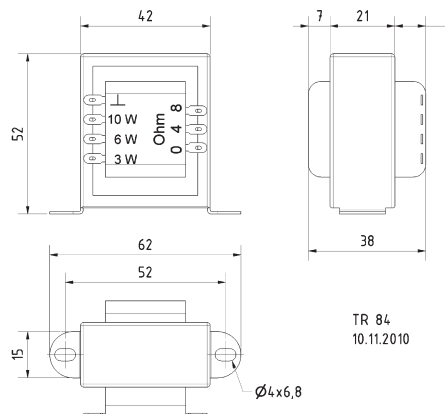

TR 84  
10.11.2010

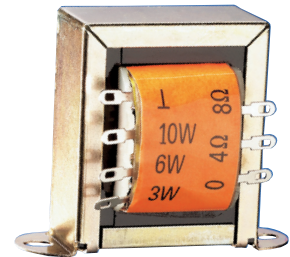

**100-V-Übertrager** für Lautsprecher in ELA-Anlagen.  
**100 V transformer** for loudspeakers in PA systems.

**TR 6.8**  
Art. No. 1806

Technische Daten / Specifications:

Primär / Primary:	6 W -	1,7 kOhm
	3 W -	3,3 kOhm
	1,5 W -	6,7 kOhm

Sekundär / Secondary: 4; 8 Ohm

Frequenzbereich/

Frequency Range: 30–22000 Hz (–3 dB)

Kabellänge/

Length of cable 0,15 m

Gewicht netto / Net weight: 0,2 kg

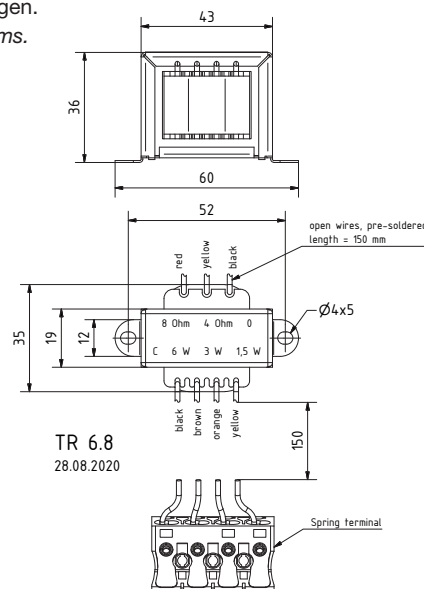

TR 6.8  
28.08.2020

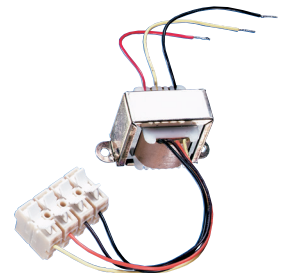

# Mouser Electronics

Authorized Distributor

Click to View Pricing, Inventory, Delivery & Lifecycle Information:

[Visaton:](#)

[1803](#)