

ISL81801EVAL1Z

Evaluation Board

The ISL81801EVAL1Z evaluation board (shown in [Figure 5](#)) features the [ISL81801](#), a 80V high voltage synchronous buck-boost controller that provides external soft-start, independent enable functions, and integrates UV/OV/OC/OT protection. A programmable switching frequency ranging from 100kHz to 600kHz helps to optimize the inductor size while the strong gate driver delivers up to 20A for the buck-boost output.

Key Features

- Wide input range: 9V to 80V
- Bi-directional operation
- High light-load efficiency in pulse skipping DEM operation
- Programmable soft-start
- Optional DEM/PWM operation
- Optional CC/HICCUP OCP protection
- Supports pre-bias output with soft-start
- PGOOD indicator
- OVP, OTP, and UVP protection
- Back biased from output to improve efficiency

Specifications

The ISL81801EVAL1Z evaluation board is designed for high current applications. The current rating of the ISL81801EVAL1Z is limited by the FETs and inductor selected. The ISL81801EVAL1Z electrical ratings are shown in [Table 1](#).

Table 1. Electrical Rating

Parameter	Rating
Input Voltage	9V to 80V
Switching Frequency	200kHz
Output Voltage	12V
Output Current	10A
OCP Set Point	Minimum 11A at ambient room temperature

Ordering Information

Part Number	Description
ISL81801EVAL1Z	High Voltage BUCK-BOOST Controller Evaluation Board

Related Literature

For a full list of related documents, visit our website:

- [ISL81801](#) device page

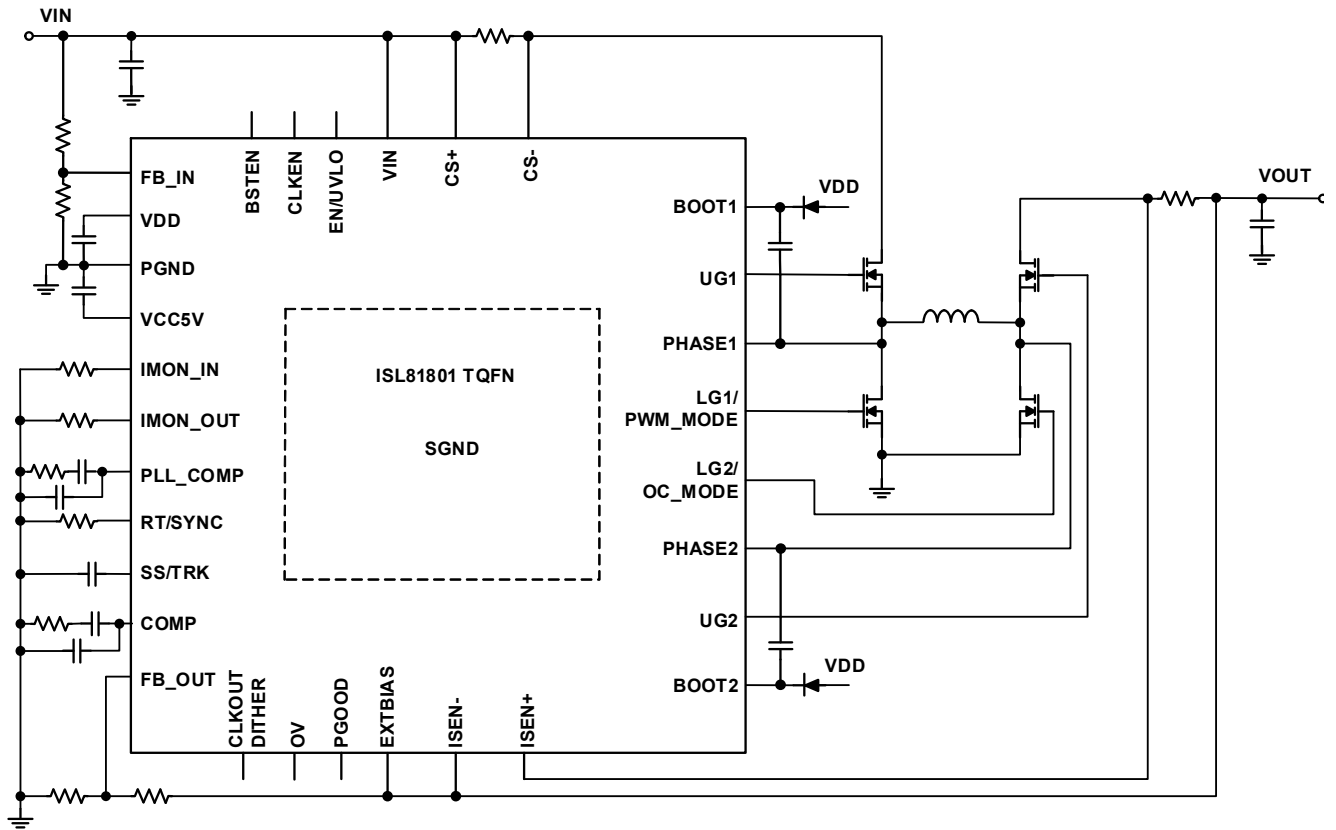

Figure 1. ISL81801EVAL1Z Block Diagram

1. Functional Description

The ISL81801EVAL1Z is the same test board used by Renesas application engineers and IC designers to evaluate the performance of the ISL81801 TQFN IC. The board provides an easy and complete evaluation of all the IC and board functions.

As shown in [Figure 4](#), 9V to 80V VIN is supplied to J1 (+) and J2 (-). The regulated 12V output on J4 (+) and J5 (-) can supply up to 10A to the load. Due to the high power efficiency, the evaluation board can run at 10A continuously without airflow at room temperature ambient conditions.

Test points TP1 through TP28 provide easy access to the IC pin and external signal injection terminals.

As shown in [Table 2](#), connector J8 provides a selection of either Forced PWM mode (shorting Pin 1 and Pin 2) or DEM mode (shorting Pin 2 and Pin 3). Connector J9 provides a selection of either constant current limit (shorting Pin 1 and Pin 2) or HICCUP OCP (shorting Pin 2 and Pin 3). Connector J3 provides an option to disable the converter by shorting its Pin 1 and Pin 2.

1.1 Recommended Testing Equipment

The following materials are recommended for testing:

- 0V to 80V power supply with at least 30A source current capability
- Electronic loads capable of sinking current up to 20A
- Digital Multimeters (DMMs)
- 100MHz quad-trace oscilloscope

1.2 Operating Range

The input voltage range is from 9V to 80V for an output voltage of 12V. If the output voltage is set to a lower value, the minimum V_{IN} can be reset to a lower value by changing the ratio of R_2 and R_3 . The minimum EN threshold that V_{IN} can be set to is 4.5V.

The rated load current is 10A with the OCP point set at minimum 11A at ambient room temperature conditions. The operating temperature range of this board is -40°C to $+85^{\circ}\text{C}$.

Note: Airflow is needed for higher temperature ambient conditions.

1.3 Bi-Directional Operation

See [Figure 2](#) for proper setup. Float the FBI pin (J7) and set the mode to CCM before powering on the board. The rated voltage of the super capacitor must be higher than 12V.

1. Adjust the input voltage higher than 9V. Switch on the input power source.
2. Switch off the input power source after the super capacitor is fully charged.

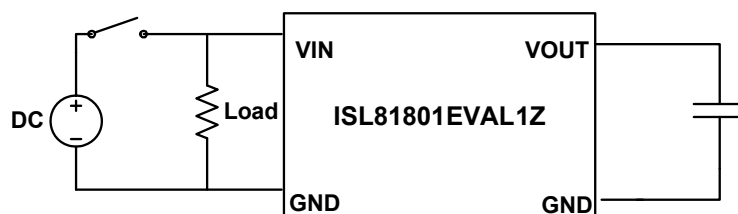

Figure 2. Proper Setup for Bi-Directional Operation

1.4 Quick Test Guide

1. Jumper J8 provides the option to select PWM or DEM. Jumper J9 provides the option to select constant current limit or HICCUP. See [Table 2](#) for the operating options. Ensure that the circuit is correctly connected to the supply and electronic loads before applying any power. See [Figure 4](#) for proper setup.
2. Turn on the power supply.
3. Adjust the input voltage (V_{IN}) within the specified range and observe the output voltage. The output voltage variation should be within 3%.
4. Adjust the load current within the specified range and observe the output voltage. The output voltage variation should be within 3%.
5. Use an oscilloscope to observe output voltage ripple and phase node ringing. For accurate measurement, see [Figure 3](#) for proper test setup.

Table 2. Operating Options

Jumper	Position	Function
3	EN-GND	Disable output
	EN Floating	Enable output
6	I _{IN} Floating	Enable input current limit
	I _{IN} -VCC5	Disable input current limit
7	FBI-GND	Disable V _{IN} limit
	FBI Floating	Enable V _{IN} limit
8	Pin 1-2	PWM
	Pin 2-3	DEM
9	Pin 1-2	Constant current limit
	Pin 2-3	HICCUP

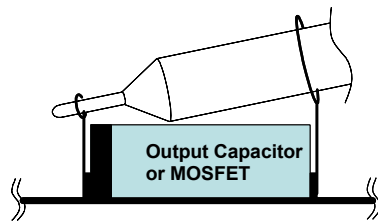

Figure 3. Proper Probe Setup to Measure Output Ripple and Phase Node Ringing

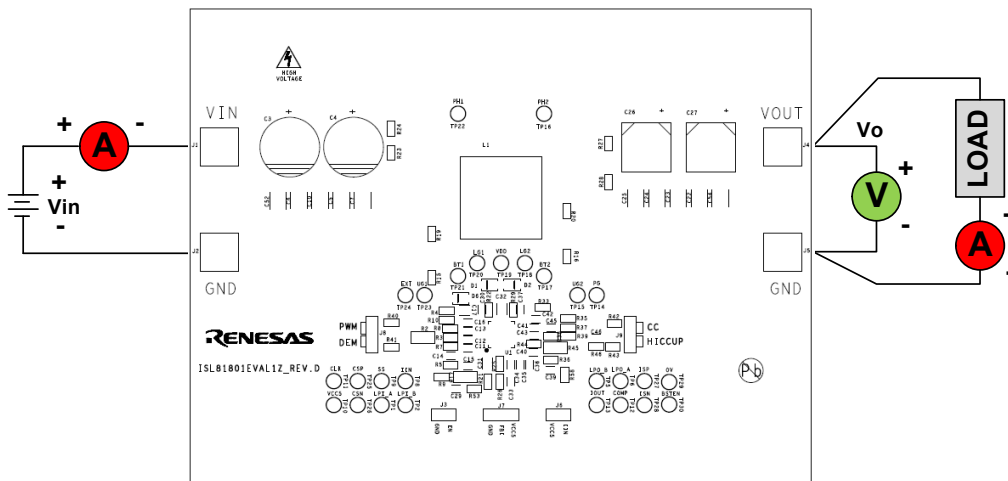

Figure 4. Proper Test Setup

2. PCB Layout Guidelines

Careful attention to Printed Circuit Board (PCB) layout requirements is necessary for successful implementation of an ISL81801 based DC/DC converter. The ISL81801 switches at a high frequency; therefore, the switching times are short. At these switching frequencies, even the shortest trace has significant impedance and the peak gate drive current rises significantly in an extremely short time. The transition speed of the current from one device to another causes voltage spikes across the interconnecting impedances and parasitic circuit elements. These voltage spikes can degrade efficiency, generate EMI, and increase device voltage stress and ringing. Careful component selection and proper PCB layout minimizes the magnitude of these voltage spikes.

Three sets of components are critical when using the ISL81801 DC/DC converter:

- Controller
- Switching power components
- Small-signal components

The switching power components are the most critical to the layout because they switch a large amount of energy, which tends to generate a large amount of noise. The critical small-signal components are those connected to sensitive nodes or those supplying critical bias currents. A multilayer PCB is recommended.

Complete the following steps to optimize the PCB layout.

1. Place the input capacitors, buck FETs, inductor, boost FETs, and output capacitor first. Isolate these power components on dedicated areas of the board with their ground terminals adjacent to one another. Place the input and output high frequency decoupling ceramic capacitors very close to the MOSFETs.
2. If signal components and the IC are placed separately from the power train, Renesas recommends using full ground planes in the internal layers with shared SGND and PGND to simplify the layout design. Otherwise, use separate ground planes for the power ground and the small signal ground. Connect the SGND and PGND together close to the IC. **Note: DO NOT** connect them together anywhere else.
3. Keep the loop formed by the input capacitor, the buck top FET, and the buck bottom FET as small as possible. Keep the loop formed by the output capacitor, the boost top FET, and the boost bottom FET as small as possible.
4. Ensure the current paths from the input capacitor to the buck FETs, the power inductor, the boost FETs, and the output capacitor are as short as possible with maximum allowable trace widths.
5. Place the PWM controller IC close to the lower FETs. The low-side FETs gate drive connections should be short and wide. Place the IC over a quiet ground area. Avoid switching ground loop currents in this area.
6. Place the VDD bypass capacitor very close to the VDD pin of the IC and connect its ground end to the PGND pin. Connect the PGND pin to the ground plane by a via.
Note: DO NOT connect the PGND pin directly to the SGND EPAD.
7. Place the gate drive components (BOOT diodes and BOOT capacitors) together near the controller IC.
8. Place the output capacitors as close to the load as possible. Use short, wide copper regions to connect output capacitors to load to avoid inductance and resistances.
9. Use copper filled polygons or wide, short traces to connect the junction of the buck or boost upper FET, buck or boost lower FET, and output inductor. Keep the buck and boost PHASE nodes connection to the IC short.
Note: DO NOT unnecessarily oversize the copper islands for the PHASE nodes. Because the phase nodes are subjected to very high dv/dt voltages, the stray capacitor formed between these islands and the surrounding circuitry tends to couple switching noise.
10. Route all high speed switching nodes away from the control circuitry.
11. Create a separate small analog ground plane near the IC. Connect the SGND pin to this plane. Connect all small signal grounding paths including feedback resistors, current monitoring resistors and capacitors, soft-starting capacitors, loop compensation capacitors and resistors, and EN pull-down resistors to this SGND plane.

- 12. Use a pair of traces with minimum loop for the input or output current sensing connection.
- 13. Ensure the feedback connection to the output capacitor is short and direct.

2.1 ISL81801EVAL1Z Evaluation Board

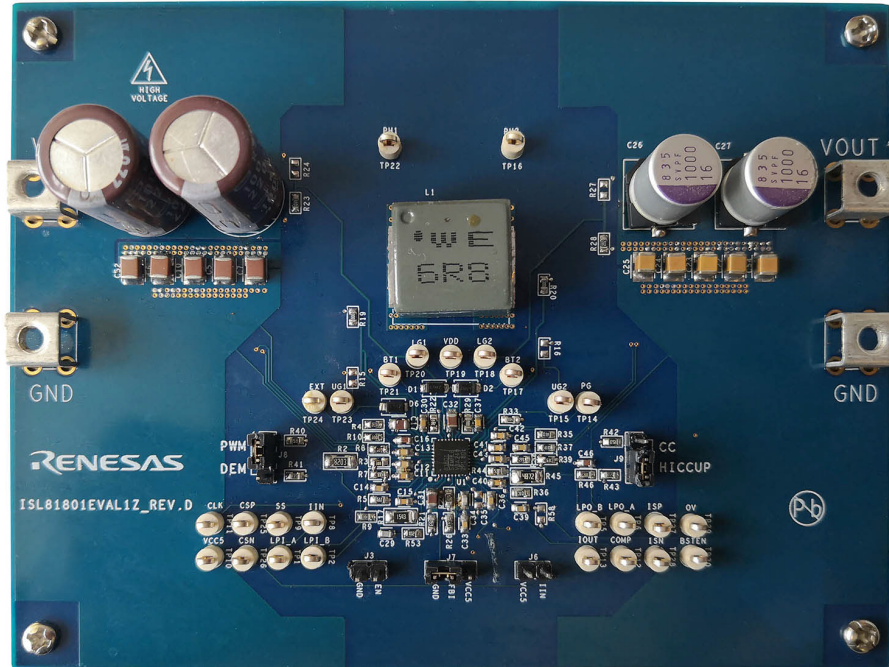

Figure 5. ISL81801EVAL1Z Evaluation Board, Top View

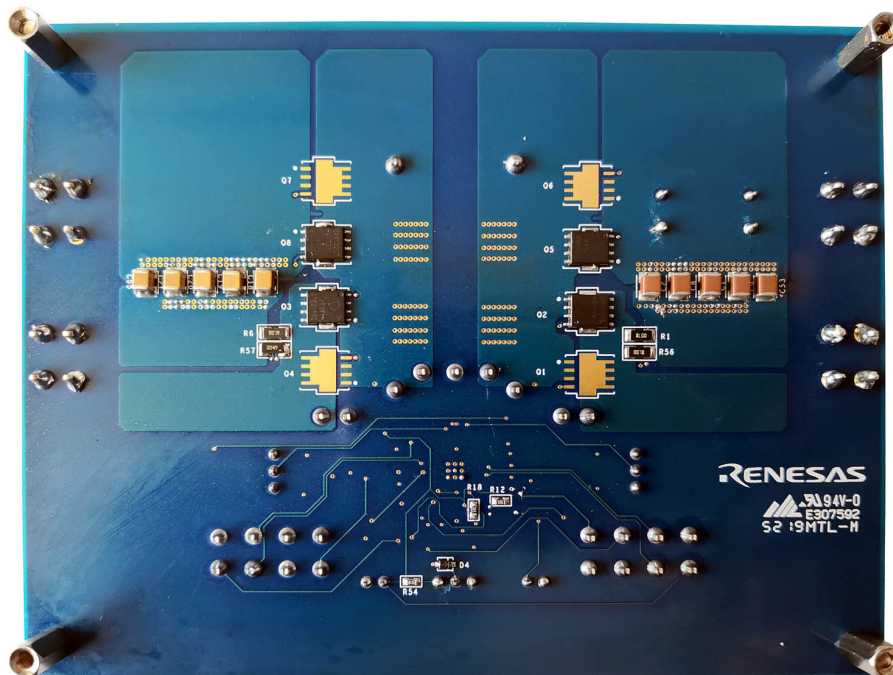

Figure 6. ISL81801EVAL1Z Evaluation Board, Bottom View

2.2 ISL81801EVAL1Z Circuit Schematic

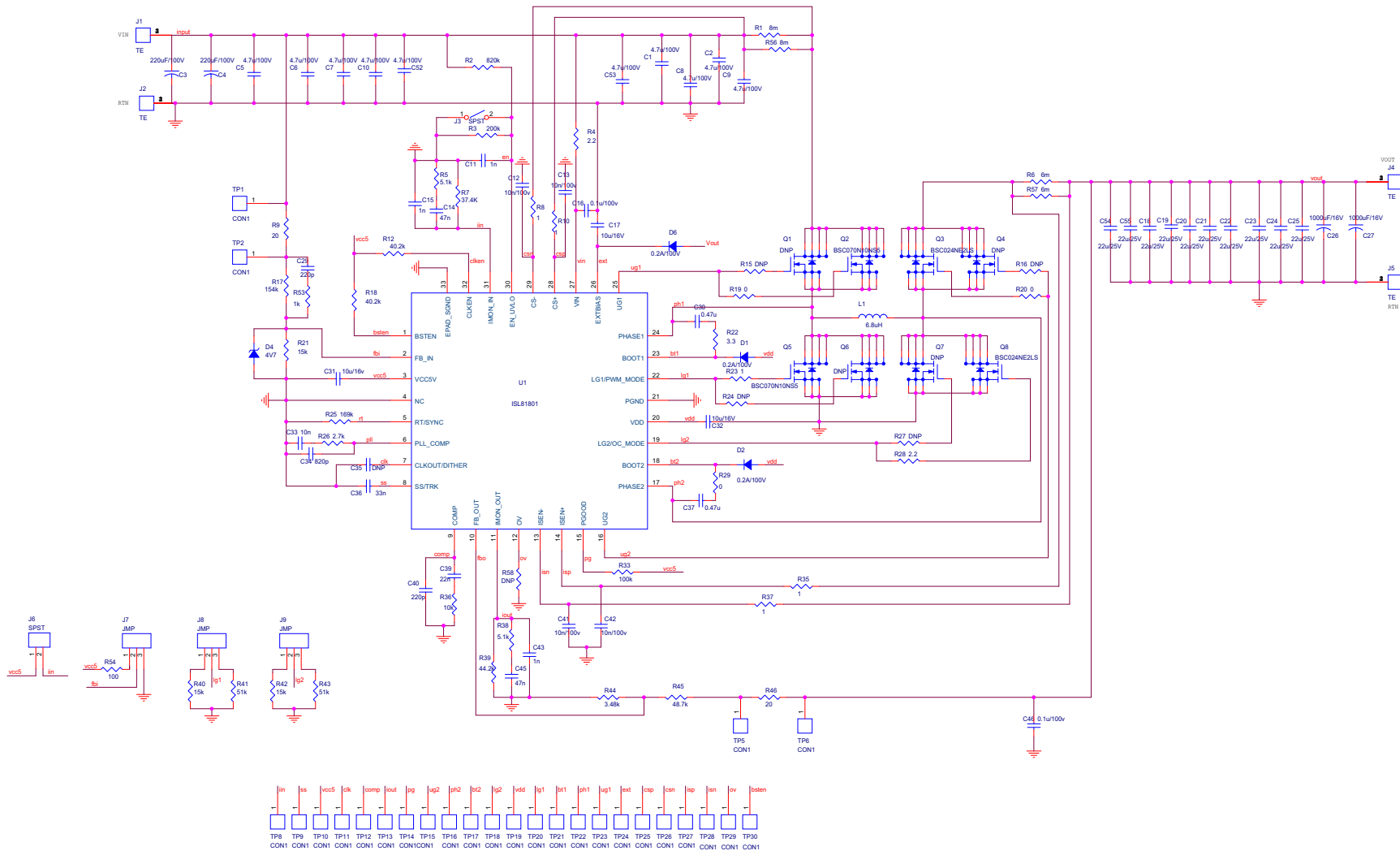

Figure 7. Schematic



2.3 Bill of Materials

Qty	Reference Designator	Description	Manufacturer	Manufacturer Part
1		PWB-PCB, ISL81801EVAL1Z, REVD, ROHS	IMAGINEERING INC	ISL81801EVAL1ZREVDPCB
1	C33	CAP-AEC-Q200, SMD, 0603, 0.01 μ F, 50V, 10%, X7R, ROHS	TDK	CGA3E2X7R1H103K080AE
10	C1, C2, C5, C6, C7, C8, C9, C10, C52, C53	CAP-AEC-Q200, SMD, 1210, 4.7 μ F, 100V, 10%, X7S, ROHS	TDK	CGA6M3X7S2A475K200AE
1	C39	CAP-AEC-Q200, SMD, 0603, 0.022 μ F, 25V, 10%, X7R, ROHS	TDK	CGJ3E2X7R1E223K080AA
1	C36	CAP-AEC-Q200, SMD, 0603, 0.033 μ F, 25V, 10%, X7R, ROHS	TDK	CGJ3E2X7R1E333K080AA
2	C14, C45	CAP-AEC-Q200, SMD, 0603, 0.047 μ F, 25V, 10%, X7R, ROHS	TDK	CGJ3E2X7R1E473K080AA
2	C16, C46	CAP-BOARDFLEX, SMD, 0603, 0.1 μ F, 100V, 10%, X7R, ROHS	MURATA	GRJ188R72A104KE11D
3	C17, C31, C32	CAP, SMD, 0805, 10 μ F, 16V, 10%, X7S, ROHS	MURATA	GRM21BC71C106KE11L
10	C18, C19, C20, C21, C22, C23, C24, C25, C54, C55	CAP, SMD, 1210, 22 μ F, 25V, 10%, X7R, ROHS	MURATA	GRM32ER71E226KE15L
3	C11, C15, C43	CAP, SMD, 0603, 1000pF, 50V, 10%, X7R, ROHS	AVX	06035C102KAT2A
4	C12, C13, C41, C42	CAP, SMD, 0603, 220pF, 100V, 5%, X7R, ROHS	PANASONIC	C0603C103J1RACTU
1	C29	CAP, SMD, 0603, 0.01 μ F, 100V, 10%, X7R, ROHS	PANASONIC	ECJ-1VB2A221K
1	C40	CAP, SMD, 0603, 220pF, 50V, 10%, X7R, ROHS	MURATA	GRM188R71H221KA01D
2	C30, C37	CAP, SMD, 0603, 0.47 μ F, 25V, 10%, X7R, ROHS	MURATA	GRM188R71E474KA12D
1	C34	CAP, SMD, 0603, 820pF, 50V, 10%, X7R, ROHS	KEMET	C0603C821K5RACTU
0	C35	CAP, SMD, 0603, DNP-PLACE HOLDER, ROHS		
2	C26, C27	CAP-OSCON, SMD, 10mm, 1000 μ F, 16V, 20%, 12m Ω , ROHS	SANYO	16SVPF1000M
4	C3, C4	CAP, RADIAL, 12.5x26.5, 220 μ F, 100V, 20%, ALUM.ELEC., 5mm, ROHS	UNITED CHEMI-CON	EKZN101ELL221MK25S
1	L1	COIL-PWR INDUCTOR, SMD, 16.4mm, 6.8 μ H, 20%, 46A, 4.1m Ω , ROHS	WURTH	74439370068
27	TP1, TP2, TP5, TP6, TP8-TP30	CONN-COMPACT TEST PT, VERTICAL, WHT, ROHS	KEYSTONE	5007
2	J3, J6	CONN-HEADER, 1x2, BRKAWY 1x36, 2.54mm, ROHS	BERG/FCI	68000-236HLF
3	J7, J8, J9	CONN-HEADER, 1x3, BREAKAWY 1x36, 2.54mm, ROHS	BERG/FCI	68000-236HLF
3	J7-Pins FBI-GND, J8-Pins PWM, J9-Pins CC	CONN-JUMPER, SHORTING, 2PIN, BLACK, GOLD, ROHS	SULLINS	SPC02SYAN
3	D1, D2, D6	DIODE-RECTIFIER, SMD, 2P, S0D-123FL, 100V, 1A, ROHS	On Semiconductor	MBR1H100SFT3G

Qty	Reference Designator	Description	Manufacturer	Manufacturer Part
1	D4	DIODE-ZENER, SMD, SOD-323, 4.7V, 6%, 300mW, ROHS	Diodes, Inc.	MM3Z4V7T1G
1	U1	IC-80V 4-SWITCH PWM CONTROLLER, 32P, TQFN, 5x5, ROHS	Renesas Electronics America	ISL81801FRTZ
2	Q3, Q8	TRANSIST-MOS, N-CHANNEL, SMD, 8P, PG-TDSON, 25V, 25A, ROHS	Infineon Technology	BSC024NE2LSATMA1
2	Q2, Q5	TRANSISTOR-MOS, N-CHANNEL, SMD, 8P, PPK SO-8, 100V, 80A, ROHS	Infineon Technology	BSC070N10NS5ATMA1
4	R8, R10, R23, R35, R37	RES, SMD, 0603, 1 Ω , 1/10W, 1%, TF, ROHS	Panasonic	ERJ-3RQF1R0V
2	R9, R46	RES, SMD, 0603, 20 Ω , 1/10W, 1%, TF, ROHS	Panasonic	ERJ-3EKF20R0V
2	R4, R28	RES, SMD, 0603, 2.2 Ω , 1/10W, 1%, TF, ROHS	Panasonic	ERJ-3RQF2R2V
3	R19, R20, R29	RES, SMD, 0603, 0 Ω , 1/10W, TF, ROHS	Venkel	CR0603-10W-000T
1	R22	RES, SMD, 0603, 3.3 Ω , 1/10W, 1%, TF, ROHS	Panasonic	ERJ-3RQF3R3V
1	R54	RES, SMD, 0603, 100 Ω , 1/10W, 1%, TF, ROHS	Venkel	CR0603-10W-1000FT
1	R53	RES, SMD, 0603, 1k, 1/10W, 1%, TF, ROHS	Panasonic	ERJ-3EKF1001V
1	R36	RES, SMD, 0603, 10k, 1/10W, 1%, TF, ROHS	Venkel	CR0603-10W-1002FT
1	R33	RES, SMD, 0603, 100k, 1/10W, 1%, TF, ROHS	Venkel	CR0603-10W-1003FT
3	R21, R40, R42	RES, SMD, 0603, 15k, 1/10W, 1%, TF, ROHS	Panasonic	ERJ-3EKF1502V
1	R25	RES, SMD, 0603, 169k, 1/10W, 1%, TF, ROHS	Venkel	CR0603-10W-1693FT
1	R3	RES, SMD, 0603, 200k, 1/10W, 1%, TF, ROHS	Venkel	CR0603-10W-2003FT
1	R53	RES, SMD, 0603, 200k, 1/10W, 1%, TF, ROHS	Venkel	CR0603-10W-2003FT
1	R26	RES, SMD, 0603, 2.7k, 1/10W, 1%, TF, ROHS	Venkel	CR0603-10W-2701FT
1	R44	RES, SMD, 0603, 3.48k, 1/10W, 1%, TF, ROHS	Panasonic	ERJ-3EKF3481V
1	R7	RES, SMD, 0603, 37.4k, 1/10W, 1%, TF, ROHS	Yageo	RC0603FR-0737K4L
2	R12, R18	RES, SMD, 0603, 40.2k, 1/10W, 1%, TF, ROHS	Yageo	RC0603FR-0740K2L
1	R39	RES, SMD, 0603, 44.2k, 1/10W, 1%, TF, ROHS	Venkel	CR0603-10W-4422FT
2	R5, R38	RES, SMD, 0603, 5.1k, 1/10W, 1%, TF, ROHS	Venkel	CR0603-10W-5101FT
2	R41, R43	RES, SMD, 0603, 51k, 1/10W, 1%, TF, ROHS	Yageo	RC0603FR-0751KL
0	R15, R16, R24, R27, R58	RES, SMD, 0603, DNP-PLACE HOLDER, ROHS		

Qty	Reference Designator	Description	Manufacturer	Manufacturer Part
1	R17	RES, SMD, 1206, 154k, 1/4W, 1%, TF, ROHS	Yageo	RC1206FR-07154KL
1	R45	RES, SMD, 1206, 48.7k, 1/4W, 1%, TF, ROHS	Yageo	RC1206FR-0748K7L
1	R2	RES, SMD, 1206, 820k, 1/4W, 1%, TF, ROHS	Yageo	AC1206FR-07820KL
2	R6, R57	RES, SMD, 1206, 0.006Ω, 1W, 1%, TF, ROHS	Rohm	PMR18EZPFU6L00
2	R1, R56	RES, SMD, 1206, 0.008Ω, 1W, 1%, TF, ROHS	Rohm	PMR18EZPFU8L00
4	Four corners	SCREW, 4-40X1/4in, PHILLIPS, PANHEAD, STAINLESS, ROHS	Building Fasteners	PMSSS 440 0025 PH
4	Four corners	STANDOFF, 4-40X3/4in, F/F, HEX, ALUMINUM, 0.25 OD, ROHS	Keystone	2204
4	J1, J2, J4, J5	HDWARE, TERMINAL, M4 METRIC SCREW, TH, 4P, SNAP-FIT, ROHS	Keystone	7795
1	Place assy in bag	BAG, STATIC, 6X8, ZIPLOC, ROHS	Uline	S-2262
0	Q1, Q4, Q6, Q7	DO NOT POPULATE OR PURCHASE		
0	TP3	DO NOT POPULATE OR PURCHASE		
1	AFFIX TO BACK OF PCB	LABEL-DATE CODE_LINE 1: YRWK/REV#, LINE 2: BOM NAME	Renesas Electronics America	LABEL-DATE CODE

2.4 Board Layout

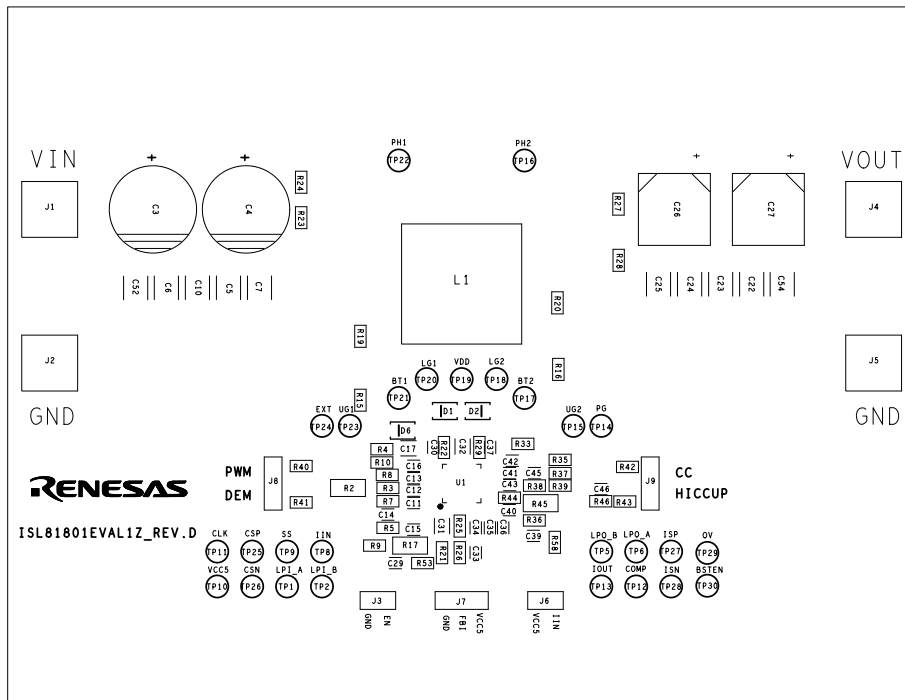

Figure 8. Silkscreen Top

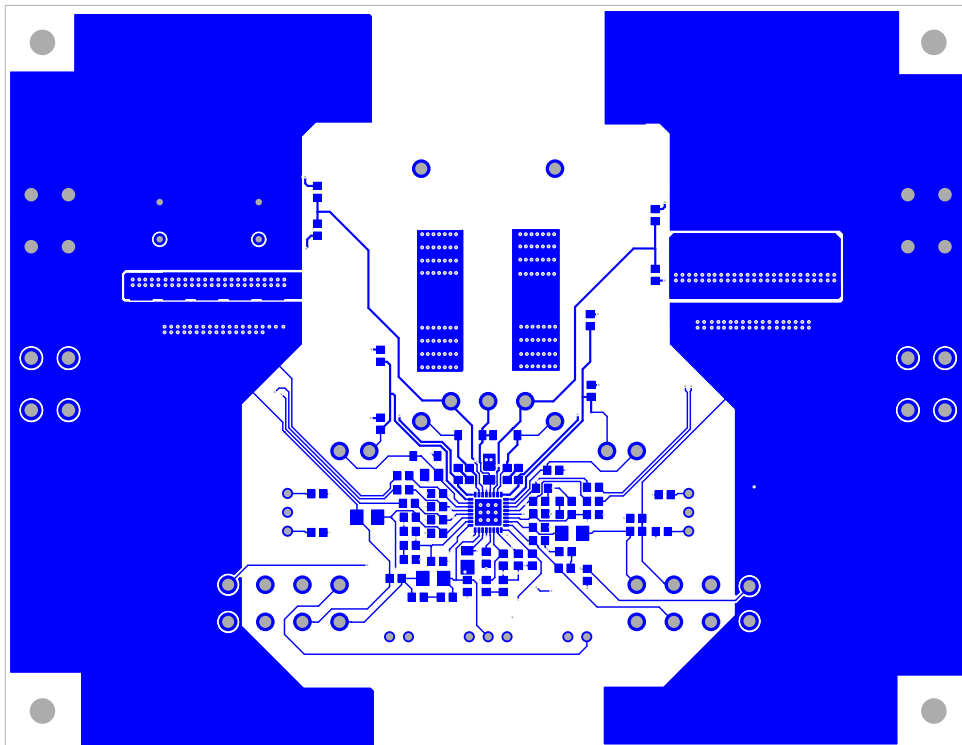

Figure 9. Top Layer

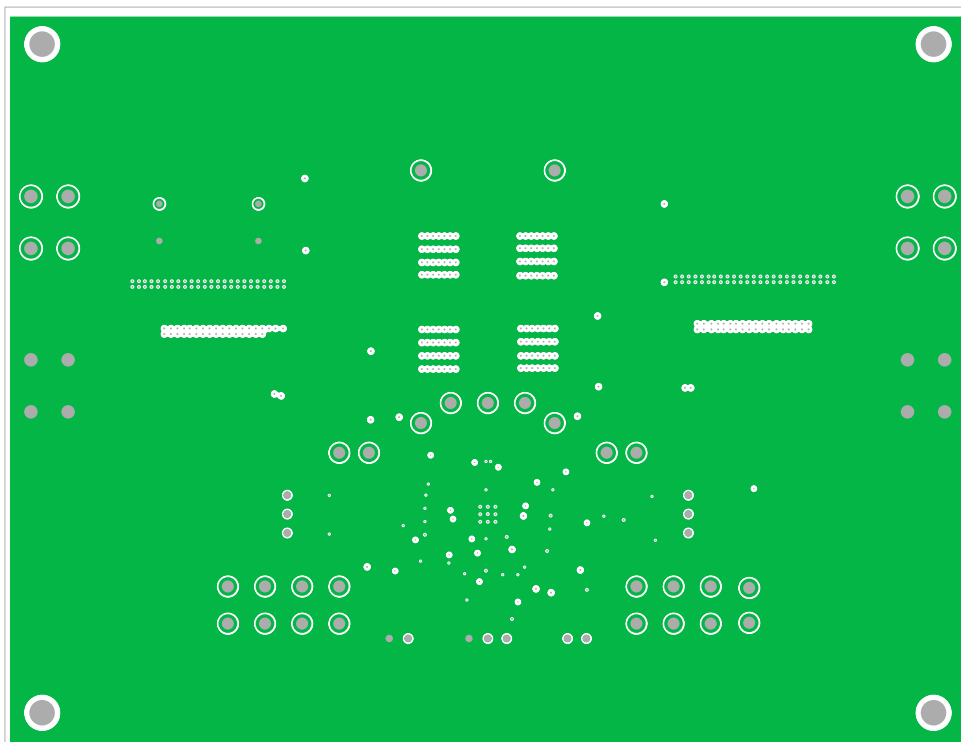

Figure 10. Second Layer (Solid Ground)

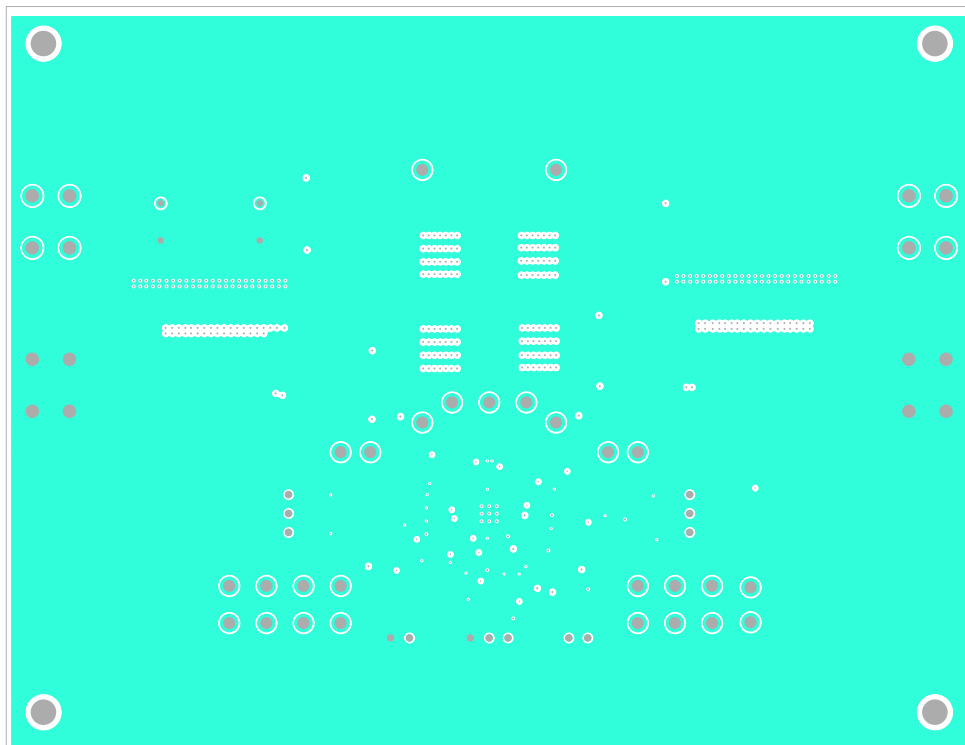

Figure 11. Third Layer

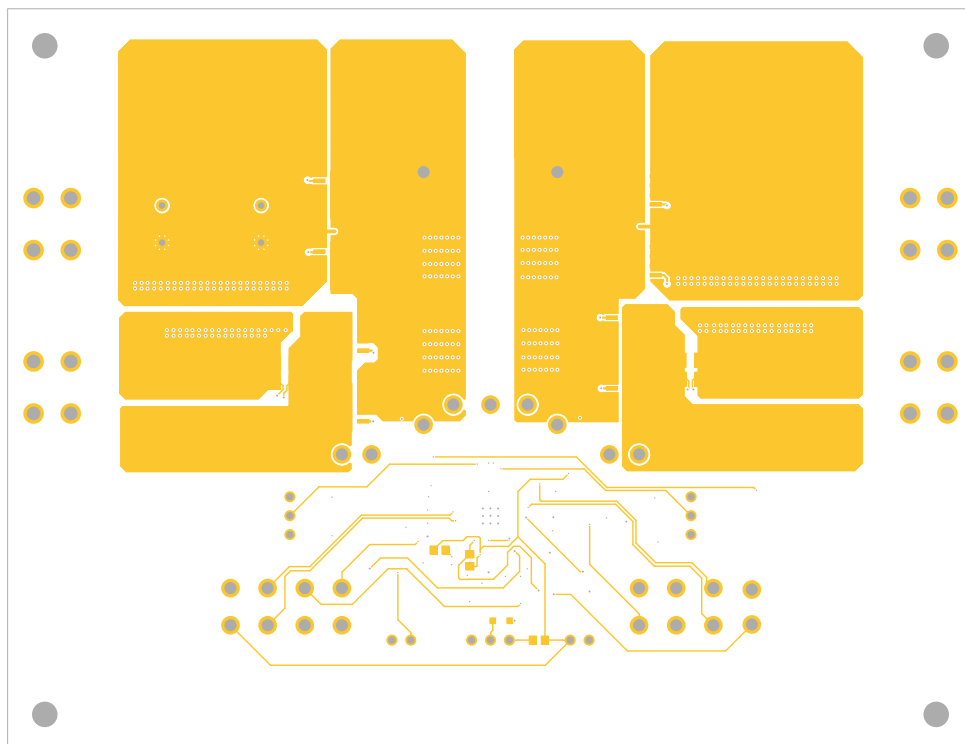

Figure 12. Bottom Layer

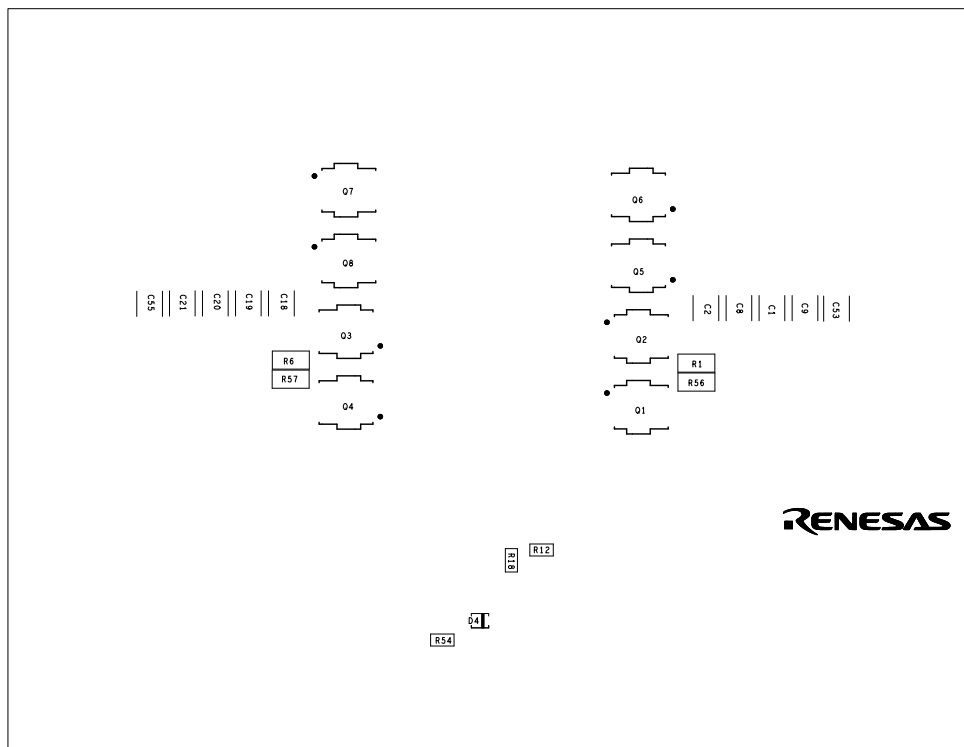

Figure 13. Silkscreen Bottom

3. Typical Performance Curves

$V_{IN} = 12V$, $T_A = 25^\circ C$, unless otherwise noted.

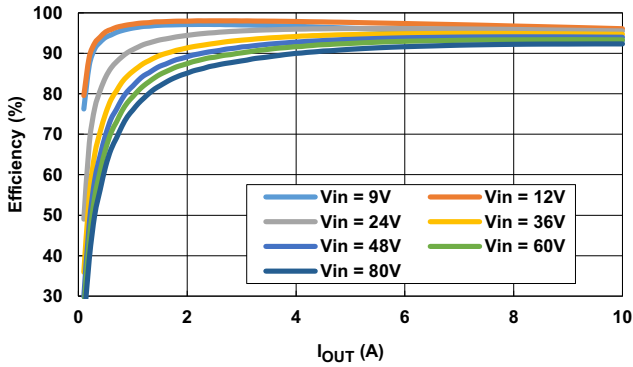

Figure 14. Efficiency, CCM

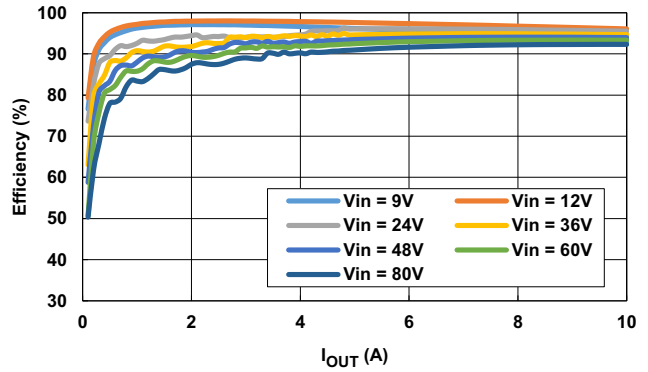

Figure 15. Efficiency, DEM

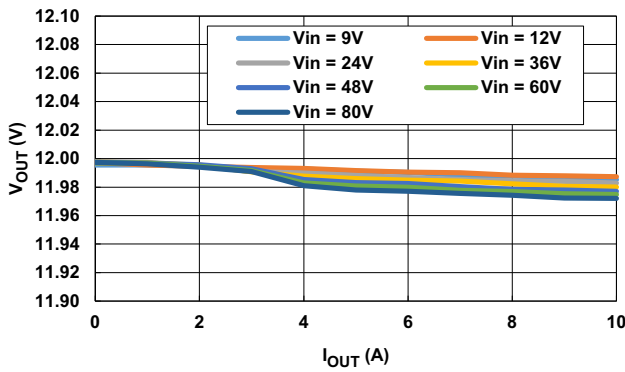

Figure 16. Load Regulation, CCM

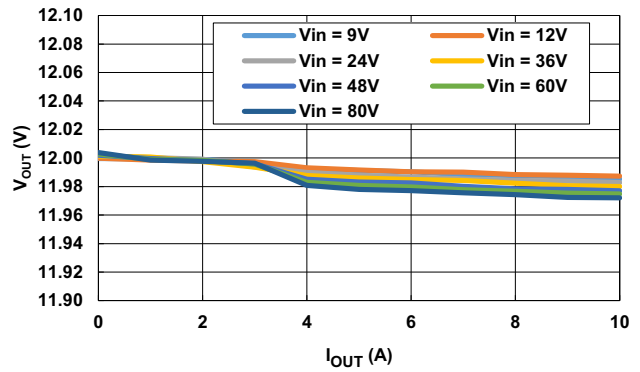

Figure 17. Load Regulation, DEM

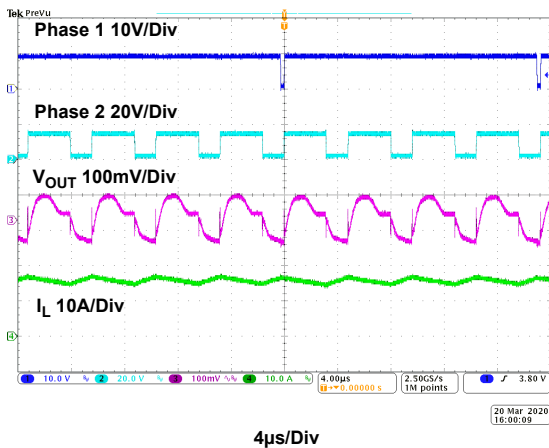

Figure 18. Phase 1, Phase 2, V_{OUT} and Inductor Current, $V_{IN} = 9V$, $I_{OUT} = 10A$

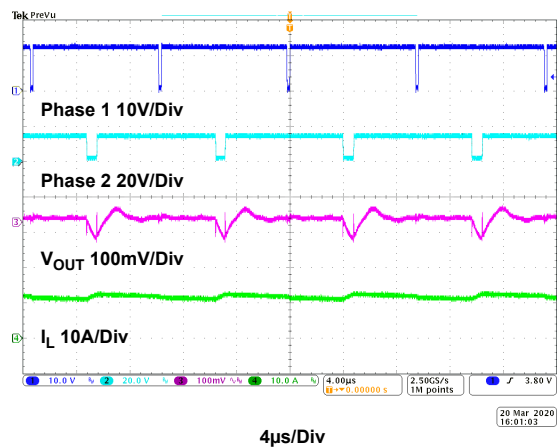

Figure 19. Phase 1, Phase 2, V_{OUT} and Inductor Current, $V_{IN} = 12V$, $I_{OUT} = 10A$

$V_{IN} = 12V$, $T_A = 25^\circ C$, unless otherwise noted. (Continued)

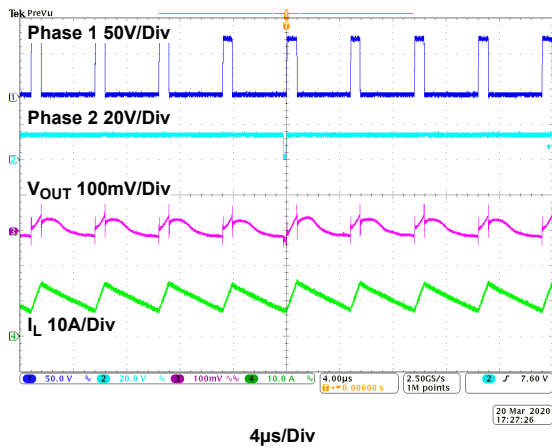

Figure 20. Phase 1, Phase 2, V_{OUT} and Inductor Current, $V_{IN} = 80V$, $I_{OUT} = 10A$

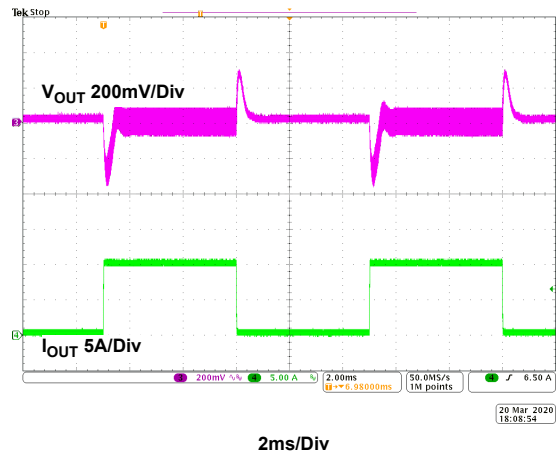

Figure 21. Load Transient, $V_{IN} = 9V$, $I_{OUT} = 0A$ to $10A$, $2.5A/\mu s$, CCM

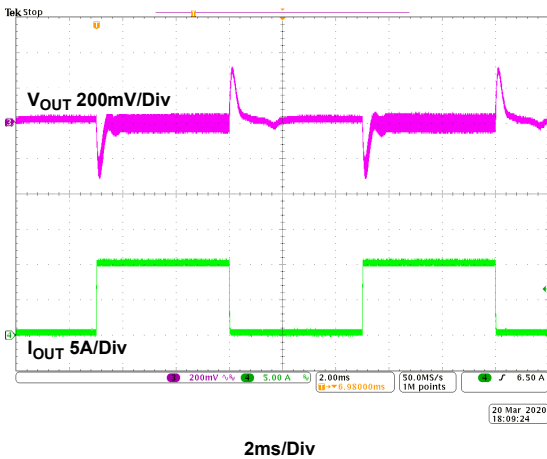

Figure 22. Load Transient, $V_{IN} = 12V$, $I_{OUT} = 0A$ to $10A$, $2.5A/\mu s$, CCM

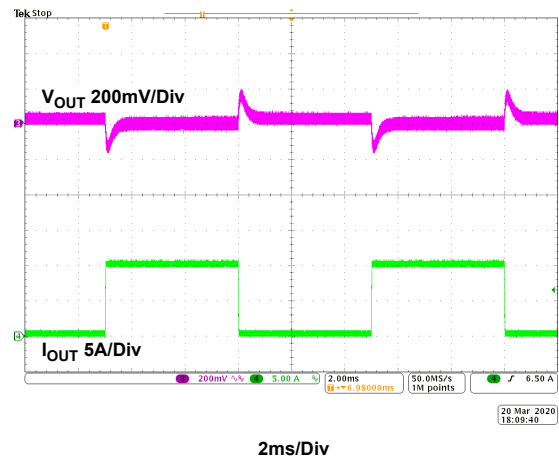

Figure 23. Load Transient, $V_{IN} = 80V$, $I_{OUT} = 0A$ to $10A$, $2.5A/\mu s$, CCM

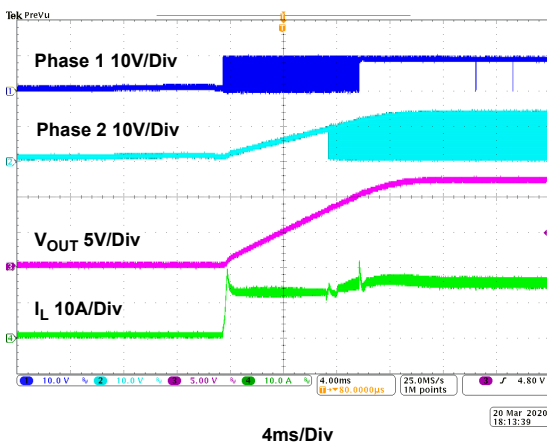

Figure 24. Start-Up Waveform, $V_{IN} = 9V$, $I_{OUT} = 10A$, CCM

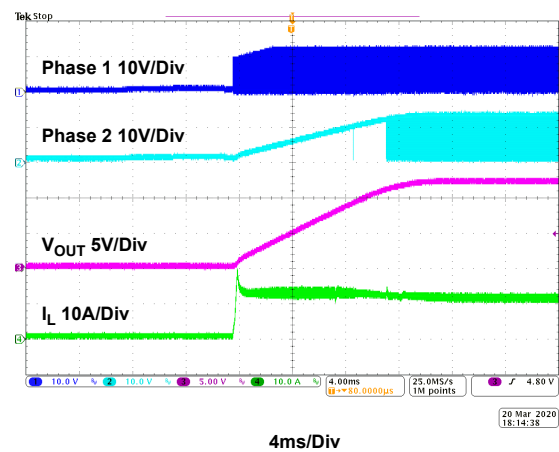

Figure 25. Start-Up Waveform, $V_{IN} = 12V$, $I_{OUT} = 10A$, CCM

$V_{IN} = 12V$, $T_A = 25^\circ C$, unless otherwise noted. (Continued)

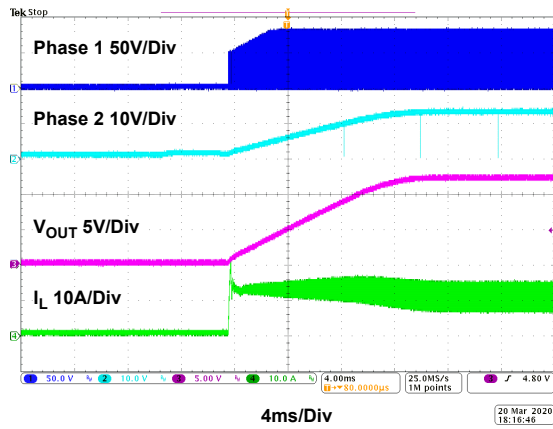

Figure 26. Start-Up Waveform, $V_{IN} = 80V$, $I_{OUT} = 10A$, CCM

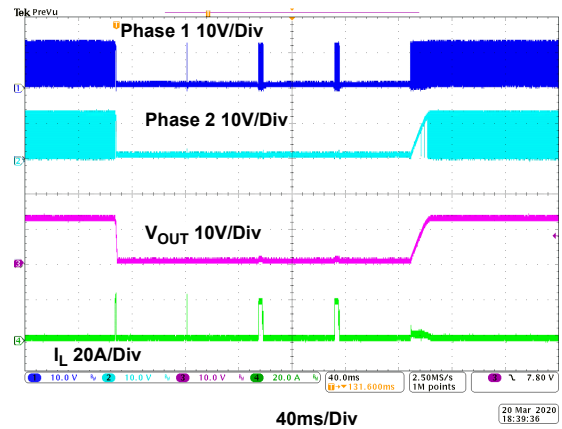

Figure 27. Short-Circuit Waveform

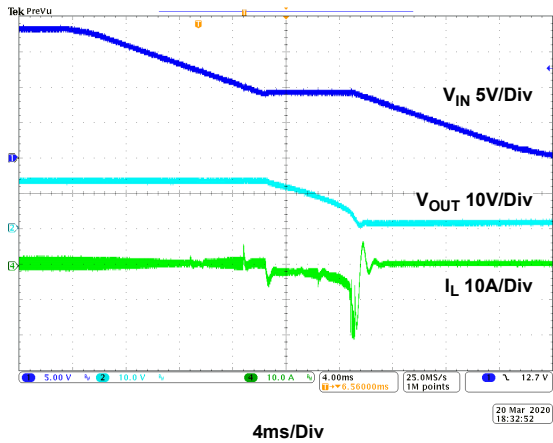

Figure 28. Bi-Directional Operation, $V_{IN} = 18V$, $V_{IN_limit} = 9V$, $I_{IN} = 1A$

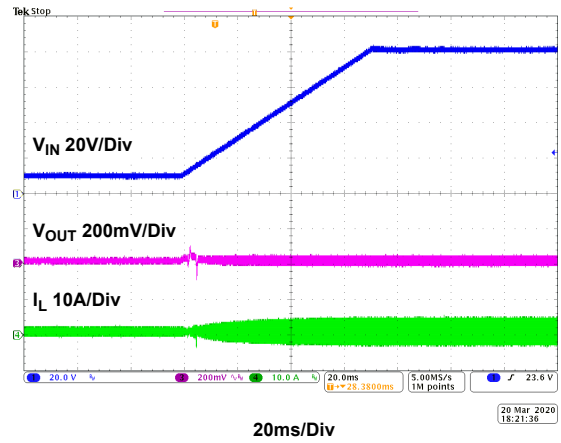

Figure 29. Line Transient, $V_{IN} = 9V$ to $80V$, $1V/ms$, $I_{OUT} = 0A$

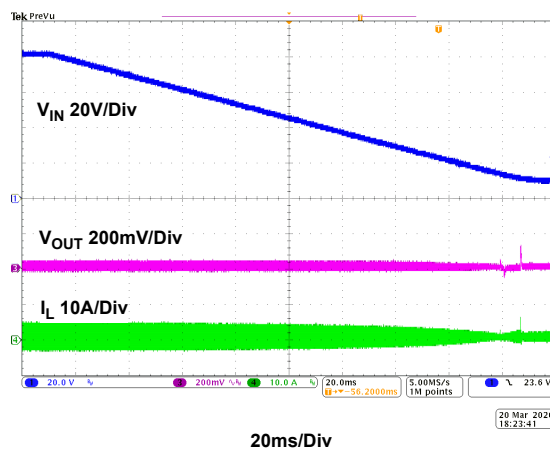

Figure 30. Line Transient, $V_{IN} = 80V$ to $9V$, $1V/ms$, $I_{OUT} = 0A$

4. Revision History

Rev.	Date	Description
1.00	May.6.20	Initial release

IMPORTANT NOTICE AND DISCLAIMER

RENESAS ELECTRONICS CORPORATION AND ITS SUBSIDIARIES (“RENESAS”) PROVIDES TECHNICAL SPECIFICATIONS AND RELIABILITY DATA (INCLUDING DATASHEETS), DESIGN RESOURCES (INCLUDING REFERENCE DESIGNS), APPLICATION OR OTHER DESIGN ADVICE, WEB TOOLS, SAFETY INFORMATION, AND OTHER RESOURCES “AS IS” AND WITH ALL FAULTS, AND DISCLAIMS ALL WARRANTIES, EXPRESS OR IMPLIED, INCLUDING, WITHOUT LIMITATION, ANY IMPLIED WARRANTIES OF MERCHANTABILITY, FITNESS FOR A PARTICULAR PURPOSE, OR NON-INFRINGEMENT OF THIRD PARTY INTELLECTUAL PROPERTY RIGHTS.

These resources are intended for developers skilled in the art designing with Renesas products. You are solely responsible for (1) selecting the appropriate products for your application, (2) designing, validating, and testing your application, and (3) ensuring your application meets applicable standards, and any other safety, security, or other requirements. These resources are subject to change without notice. Renesas grants you permission to use these resources only for development of an application that uses Renesas products. Other reproduction or use of these resources is strictly prohibited. No license is granted to any other Renesas intellectual property or to any third party intellectual property. Renesas disclaims responsibility for, and you will fully indemnify Renesas and its representatives against, any claims, damages, costs, losses, or liabilities arising out of your use of these resources. Renesas' products are provided only subject to Renesas' Terms and Conditions of Sale or other applicable terms agreed to in writing. No use of any Renesas resources expands or otherwise alters any applicable warranties or warranty disclaimers for these products.

(Rev.1.0 Mar 2020)

Corporate Headquarters

TOYOSU FORESIA, 3-2-24 Toyosu,
Koto-ku, Tokyo 135-0061, Japan
www.renesas.com

Contact Information

For further information on a product, technology, the most up-to-date version of a document, or your nearest sales office, please visit:
www.renesas.com/contact/

Trademarks

Renesas and the Renesas logo are trademarks of Renesas Electronics Corporation. All trademarks and registered trademarks are the property of their respective owners.

Mouser Electronics

Authorized Distributor

Click to View Pricing, Inventory, Delivery & Lifecycle Information:

[Renesas Electronics:](#)

[ISL81801EVAL1Z](#)