

ISL6442EVAL1Z

Evaluation Board User Guide

AN1181  
Rev 1.00  
Nov 28, 2011

This application note describes how to use the ISL6442EVAL1Z (Rev. C) board to evaluate the ISL6442 dual switching regulator, plus one linear regulator. Refer to the schematic, BOM (Bill of Materials), and board layout (at the end of this document), as needed. The [ISL6442 datasheet](#) is also used as a reference.

**Configuration**

The outputs are set up as follows:

- Switcher  $V_{OUT1} = 1.8V @ 3A$  (with  $V_{IN} = 6V$ )
- Switcher  $V_{OUT2} = 3.3V @ 3A$  (with  $V_{IN} = 6V$ )
- Linear  $V_{OUT3} = 5.0V @ 0.3A$  (with  $V_{IN3} = 6V$ )

The outputs are switching at  $\sim 1.4MHz$  rate, based on the resistor selected on the RT pin.

The current range for the switcher output that is presently supported is limited by the FETs used. The FDS6912A dual FET (in SO-8 package) can handle up to 3A. However, the ISL6442 gate drivers are capable of driving discrete upper and lower FETs for up to 25A output current as well, even though not supported on this board.

The linear output supports  $\sim 1W$ . The output current capability of the linear regulator is determined mainly by the power dissipation of the FET as mounted:

$$PV_{OUT3} = (V_{IN3} - V_{OUT3}) * I_{OUT3}$$

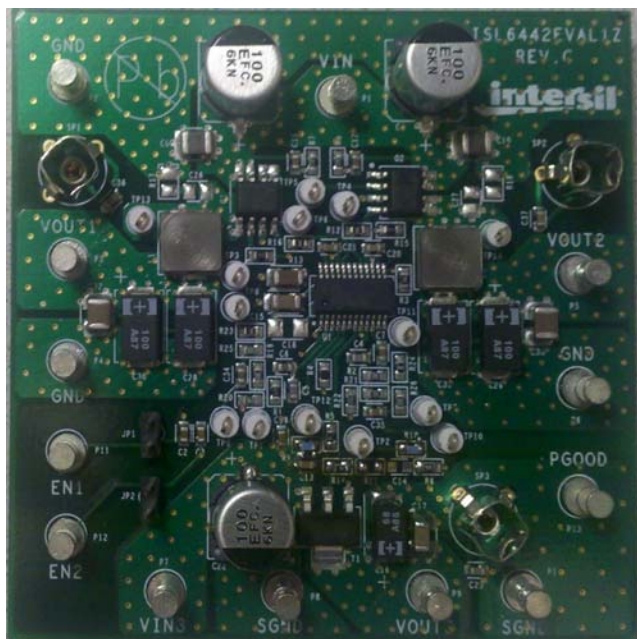

FIGURE 1. ISL6442EVAL1Z BOARD PHOTO

**Quick Start Evaluation**

Figure 1 shows a photo of the populated board, and Figure 2 shows a plot of the top layer for reference, and details the available input and output connections. Two switchers share one input  $V_{IN}$ . The linear regulator has separate turrets for its input ( $V_{IN3}$ ) and GND. Each output has turrets for  $V_{OUT}$  and GND, plus a scope probe socket, for low noise waveforms.

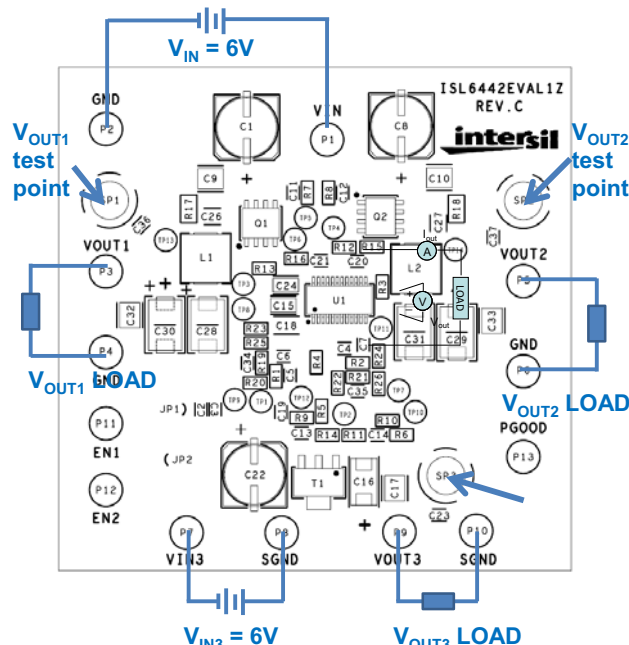

FIGURE 2. ISL6442EVAL1Z INPUT AND OUTPUT CONNECTIONS

**Quick Start Setup (Light Load)**

For a quick and easy test, one 6V supply is needed. Connect P1 ( $V_{IN}$ ) and P7 ( $V_{IN3}$ ) to each other, and to the 6V supply; connect the supply GND to P2 and P9. Attach light loads to each output.

Switch on the power supply; all three outputs should turn on to their expected DC values; use a voltmeter or oscilloscope to view them.  $V_{OUT1}$  and  $V_{OUT2}$  will have a ramp time of a few milliseconds ( $V_{OUT3}$  will be much faster).

Note that the IC and all three inputs are sharing one supply voltage in this simple example. The linear  $V_{IN3}$  can certainly be different, since it has its own input posts.

**Board Features and Modifications**

Heavier loads can be evaluated by placing them across the appropriate output to GND. Resistors, electronic loads, or actual loads can be used. It is **STRONGLY** recommended that the power be turned off when attaching loads, due to the tight

spacing of the posts. The switcher outputs should be able to provide at least 3A; monitor the FET temperature if you try to go higher, to be sure the conditions will allow it. Make sure the input power supply can source the amount of input current necessary to drive the maximum loads to be tested.

The linear VOUT3 is especially sensitive to power dissipation concerns; it will change as the user varies either the input voltage, the output voltage, and/or the load current. The equation used is  $P_{VOUT3} = (V_{IN3} - V_{OUT3}) * I_{OUT3}$ . The PNP bipolar will also be rated for how well the power is dissipated from the package and spread out on the board; this is another variable that the user must keep in mind for their design and layout.

JP1 is used to disable VOUT1, by shorting SS/EN1 to GND. JP2 does the same function for VOUT2.

The switching frequency is controlled by a resistor (R4) on the RT pin, to GND. Refer to the datasheet for the curve of resistor values versus frequency.

Each output voltage is determined by a resistor divider from the output to its FB pin to GND. See the [ISL6442 datasheet](#) for the formulas to calculate the values. Note that there are some limitations; the switchers can approach 100% duty, but will be limited by dead time,  $r_{DS(on)}$  of the FETs at maximum load, switching frequency, etc. The maximum values are limited by the VIN available (if you want go higher, check the ratings of the FETs, and other output components to be sure they can handle it). The minimum output voltage will be just above the 0.6V internal reference. The maximum output voltage for the linear is limited by the VIN3 and the LCDR pin (which is biased from 5V). Thus, the maximum output voltage is close to the 5V set on the board; it is not recommended to go higher. The minimum voltage will also be just above the 0.6V internal reference.

## Performance Waveforms

These figures depict the ISL6442EVAL1Z performance during typical operational situations, as well as during fault conditions. Loading of the output can be most easily done via an electronic load; however, other methods can work as well.

Figure 3 shows a typical power-up sequence, with all inputs connected to a single VIN = VIN3 = 6V. When VCC exceeds its POR rising trip point (~4.4V), the IC is enabled, and the linear VOUT3 comes up almost immediately. Meanwhile, the two SS/EN pins start charging (not shown), but the outputs do not start ramping until the SS/EN pins ~1V; then both switcher outputs start their soft-start ramps at the same time. In this case, both

outputs track each other initially; this is accomplished by selecting the ratio of SS/EN capacitors to match their output voltages. The ramp times shown are on the order of a few milliseconds, as determined by the SS/EN capacitors on the board.

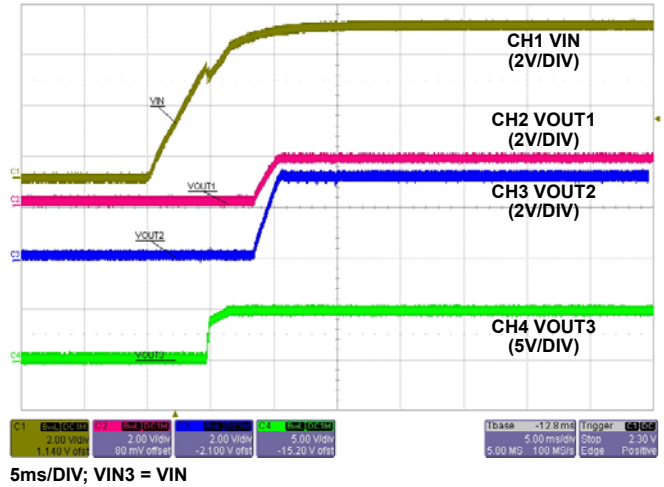

FIGURE 3. TYPICAL POWER-UP WAVEFORMS WITH VIN

Figure 4 shows the detail soft start waveform of PWM1 (PWM2 would be similar). The full SS/EN1 ramp is shown; the output doesn't start to ramp until the SS/EN passes the ~1V threshold for Enable. The output ramps from zero to full scale, while SS/EN1 ramps from 1.0V to 1.6V. Finally, the EN/SS1 keeps ramping up to ~3.2V, at which point the ramp is considered done (the PGOOD timer would start from this point, if both outputs ramps were done).

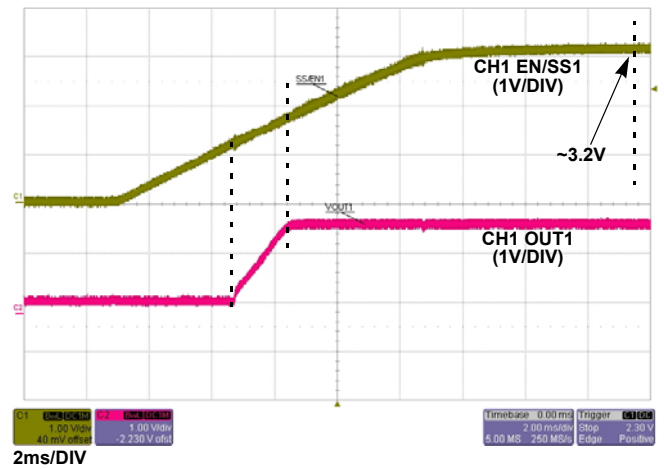

FIGURE 4. PWM1 SOFT-START

Figures 5 and 6 show the PHASE1 signal (which has the same timing as UGATE1) and the output voltage ripple on VOUT1 at no load and 3A load. The switching frequency is 1.4 MHz.

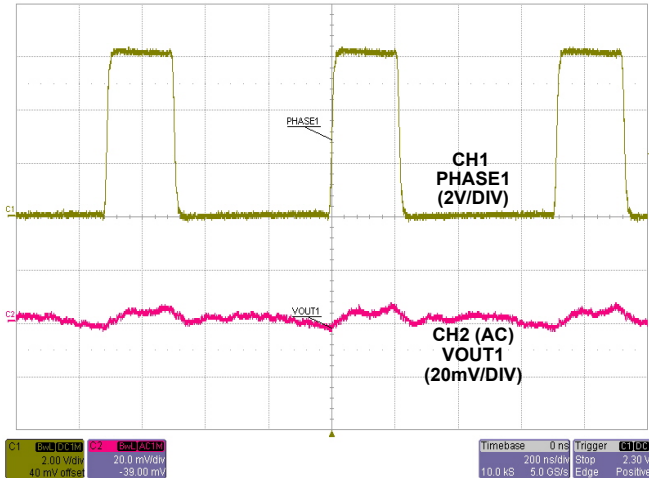

FIGURE 5. PWM1 SWITCHING AND RIPPLE WAVEFORMS AT NO LOAD

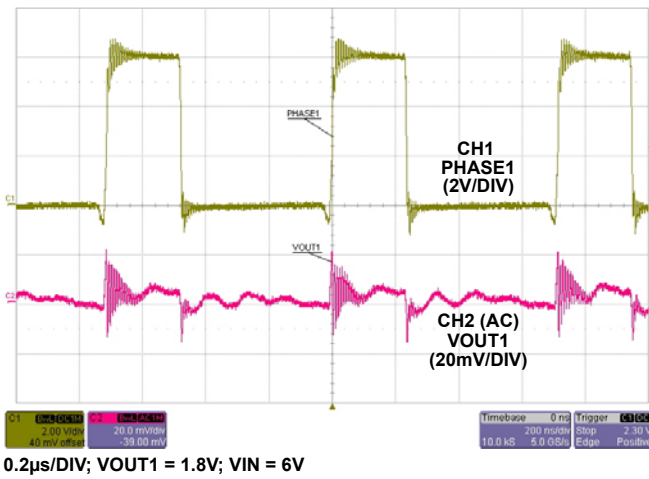

FIGURE 6. PWM1 SWITCHING AND RIPPLE WAVEFORMS AT 3A LOAD

Figure 7 shows the overcurrent hiccup mode already in operation. At time T0, the SS/EN2 is discharged to GND (it may not have time to reach GND, due to the limited size of the discharge transistor, plus the size of the timing capacitor). Once SS/EN2 is below ~1V, the output should shut off, and the load current goes to zero; this occurs by time T1. Once SS/EN2 rises above 1V again, the VOUT2 will try to turn on again. If the output remains shorted, the output current will be limited on each clock cycle to an average value low enough to keep the dissipation reasonable.

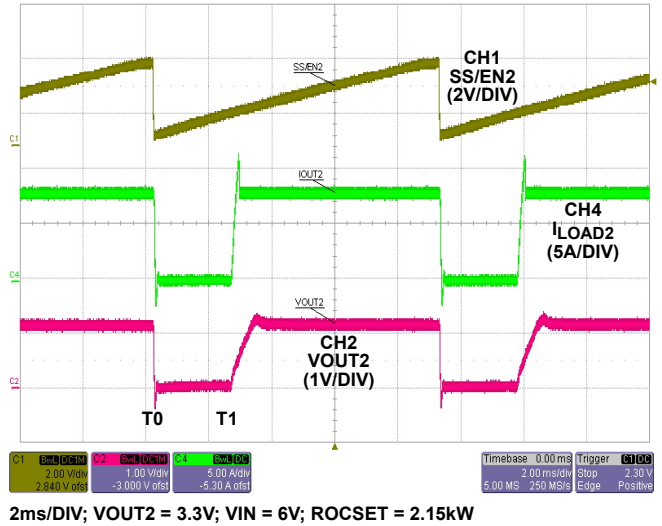

FIGURE 7. PWM2 OVERCURRENT HICCUP MODE

## Conclusion

The ISL6442EVAL1Z evaluation board showcases a simple, but high-performance dual regulator, providing control in a variety of applications, with emphasis on computer systems. The high-current MOSFET drivers of the ISL6442 yield a highly efficient power conversion solution with a reduced number of external components in a compact footprint.

## Documentation

See the following pages for more detailed information, including:

- “Schematic” of ISL6442EVAL1Z
- Table 1, “BILL OF MATERIALS” on page 5
- “ISL6442EVAL1Z Board Layout” on page 7. Note that this board layout has not been fully optimized for performance or minimum board area, primarily due to the various options, test points, and other features to make testing easier. So while it follows most of the recommended practices, it could potentially be improved for any given single application.

## References

Datasheet: [ISL6442 datasheet](#)

Visit us on the internet, at: <http://www.intersil.com>

# Schematic

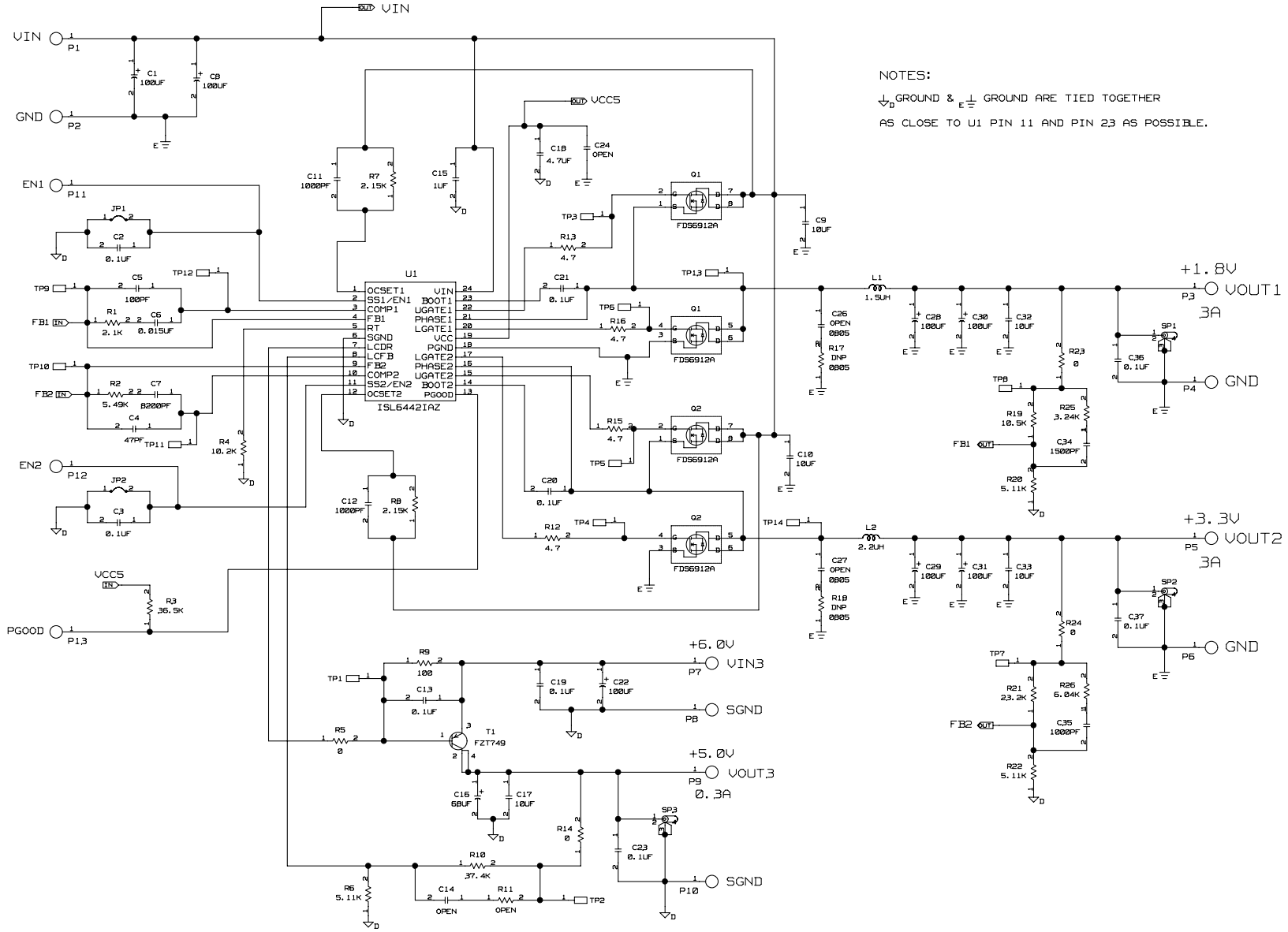

NOTES:  
 ⚡ GROUND & E ⚡ GROUND ARE TIED TOGETHER  
 AS CLOSE TO U1 PIN 11 AND PIN 23 AS POSSIBLE.

TABLE 1. BILL OF MATERIALS

| ITEM | QTY | PART REFERENCE          | VALUE        | DESCRIPTION   | PART #                 | MANUFACTURER           |
|------|-----|-------------------------|--------------|---|------------------------|------------------------|
| 1    | 4   | C28-C31                 | 100 $\mu$ F  | CAP-TANT LOWESR, SMD, D3, 100 $\mu$ F, 10V, 20%, POSCAP, ROHS | 10TPB100M              | SANYO                  |
| 2    | 1   | C16                     | 68 $\mu$ F   | CAP, SMD, 6x3.2, 68 $\mu$ F, 10V, 20% POSCAP, ROHS            | 10TPB68MC              | SANYO                  |
| 3    | 4   | C2, C3, C13, C19        | 0.1 $\mu$ F  | CAPACITOR, SMD, 0603, 0.10 $\mu$ F, 50V, 10%, X7R             |                        | Generic                |
| 4    | 1   | C18                     | 4.7 $\mu$ F  | CAPACITOR, SMD, 1206, 4.7 $\mu$ F, 16V, 10%, X7R, ROHS        |                        | Generic                |
| 5    | 3   | C17, C32, C33           | 10 $\mu$ F   | CAP, SMD, 1210, 10 $\mu$ F, 25V, 20%, X7R, ROHS               |                        | Generic                |
| 6    | 3   | C1, C8, C22             | 100 $\mu$ F  | CAP, SMD, 8X10.2, 100 $\mu$ F, 25V, 20%, AL.EL, ROHS          | EEE-FC1E101P           | EEE-FC1E101P           |
| 7    | 2   | C9, C10                 | 10 $\mu$ F   | CAP, SMD, 1210, 10 $\mu$ F, 35V, 10%, X5R, ROHS               |                        | Generic                |
| 8    | 1   | C5                      | 100pF        | CAP, SMD, 0603, 100pF, 50V, 5%, COG, ROHS                     |                        | Generic                |
| 9    | 3   | C11, C12, C35           | 1000pF       | CAP, SMD, 0603, 1000pF, 50V, 10%, X7R, ROHS                   |                        | Generic                |
| 10   | 5   | C20, C21, C23, C36, C37 | 0.1 $\mu$ F  | CAP, SMD, 0603, 0.1 $\mu$ F, 25V, 10%, X7R, ROHS              |                        | Generic                |
| 11   | 1   | C34                     | 1500pF       | CAP, SMD, 0603, 1500pF, 50V, 10%, X7R, ROHS                   |                        | Generic                |
| 12   | 1   | C6                      | 15nF         | CAP, SMD, 0603, .015 $\mu$ F, 50V, 10%, X7R, ROHS             |                        | Generic                |
| 13   | 1   | C4                      | 47pF         | CAP, SMD, 0603, 47pF, 50V, 5%, NPO, ROHS                      |                        | Generic                |
| 14   | 1   | C7                      | 8200pF       | CAP, SMD, 0603, 8200pF, 50V, 10%, X7R, ROHS                   |                        | Generic                |
| 15   | 1   | C15                     | 1 $\mu$ F    | CAP, SMD, 1206, 1 $\mu$ F, 50V, 10%, X7R, ROHS                |                        | Generic                |
| 16   | 1   | L1                      | 1.5 $\mu$ H  | COIL-PWR INDUCTOR, SMD, 6.9x6.5m, 1.5 $\mu$ H, 20%, 9A, ROHS  | IHLP-2525CZ-ER-1R5-M01 | IHLP-2525CZ-ER-1R5-M01 |
| 17   | 1   | L2                      | 2.2 $\mu$ H  | COIL-PWR INDUCTOR, SMD, 6.9x6.5m, 2.2 $\mu$ H, 20%, 10A, ROHS | IHLP-2525CZ-ER-2R2-M01 | IHLP-2525CZ-ER-2R2-M01 |
| 18   | 3   | SP1-SP3                 |              | CONN-SCOPE PROBE TEST PT, COMPACT, PCB MNT, ROHS              | 131-4353-00            | 131-4353-00            |
| 19   | 13  | P1-P13                  |              | CONN-TURRET, TERMINAL POST, TH, ROHS                          | 1514-2                 | 1514-2                 |
| 20   | 14  | TP1-TP14                |              | CONN-MINI TEST POINT, VERTICAL, WHITE, ROHS                   | 5002                   | 5002                   |
| 21   | 2   | JP1, JP2                |              | CONN-JUMPER, 2PIN, SHUNT, ROHS                                | SPC02SYAN              | SPC02SYAN              |
| 22   | 1   | U1                      |              | IC-PWM/LINEAR CONTROLLER, 24P, QSOP, ROHS                     | ISL6442IAZ             | ISL6442IAZ             |
| 23   | 2   | Q1, Q2                  |              | TRANSIST-DUAL MOS, N-CHAN, 8P, SOIC, 30V, 6A, ROHS            | FDS6912A               | FDS6912A               |
| 24   | 1   | T1                      |              | TRANSISTOR, PNP, SMD, SOT223, -25V, -3A, ROHS                 | FZT749                 | FZT749                 |
| 25   | 4   | R12, R13, R15, R16      | 4.7 $\Omega$ | RES, SMD, 0603, 4.7 $\Omega$ , 1/10W, 1%, TF, ROHS            |                        | Generic                |

TABLE 1. BILL OF MATERIALS (Continued)

| ITEM | QTY | PART REFERENCE    | VALUE  | DESCRIPTION                                | PART # | MANUFACTURER |
|------|-----|-------------------|--------|--|--------|--------------|
| 26   | 4   | R5, R14, R23, R24 | 0Ω     | RESISTOR, SMD, 0603, 0Ω, 1/10W, TF, ROHS   |        | Generic      |
| 27   | 1   | R9                | 100Ω   | RES, SMD, 0603, 100Ω, 1/10W, 1%, TF, ROHS  |        | Generic      |
| 28   | 1   | R4                | 10.2kΩ | RES, SMD, 0603, 10.2k, 1/10W, 1%, TF, ROHS |        | Generic      |
| 29   | 1   | R19               | 10.5kΩ | RES, SMD, 0603, 10.5k, 1/10W, 1%, TF, ROHS |        | Generic      |
| 30   | 1   | R1                | 2.1kΩ  | RES, SMD, 0603, 2.1k, 1/10W, 1%, TF, ROHS  |        | Generic      |
| 31   | 2   | R7, R8            | 2.15kΩ | RES, SMD, 0603, 2.15k, 1/10W, 1%, TF, ROHS |        | Generic      |
| 32   | 1   | R21               | 23.2kΩ | RES, SMD, 0603, 23.2k, 1/10W, 1%, TF, ROHS |        | Generic      |
| 33   | 1   | R25               | 3.24kΩ | RES, SMD, 0603, 3.24k, 1/10W, 1%, TF, ROHS |        | Generic      |
| 34   | 1   | R3                | 36.5kΩ | RES, SMD, 0603, 36.5k, 1/10W, 1%, TF, ROHS |        | Generic      |
| 35   | 1   | R10               | 37.4kΩ | RES, SMD, 0603, 37.4k, 1/10W, 1%, TF, ROHS |        | Generic      |
| 36   | 3   | R6, R20, R22      | 5.11kΩ | RES, SMD, 0603, 5.11k, 1/10W, 1%, TF, ROHS |        | Generic      |
| 37   | 1   | R2                | 5.49kΩ | RES, SMD, 0603, 5.49k, 1/10W, 1%, TF, ROHS |        | Generic      |
| 38   | 1   | R26               | 6.04kΩ | RES, SMD, 0603, 6.04k, 1/10W, 1%, TF, ROHS |        | Generic      |

# ISL6442EVAL1Z Board Layout

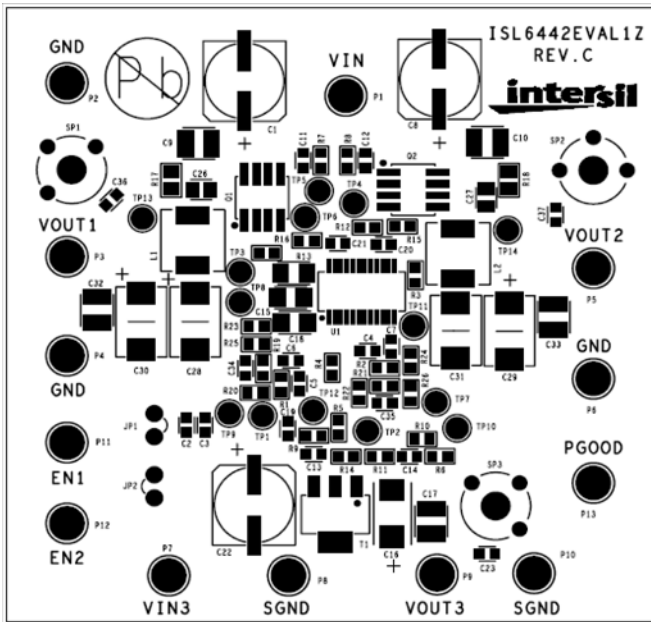

FIGURE 8. TOP SILKSCREEN

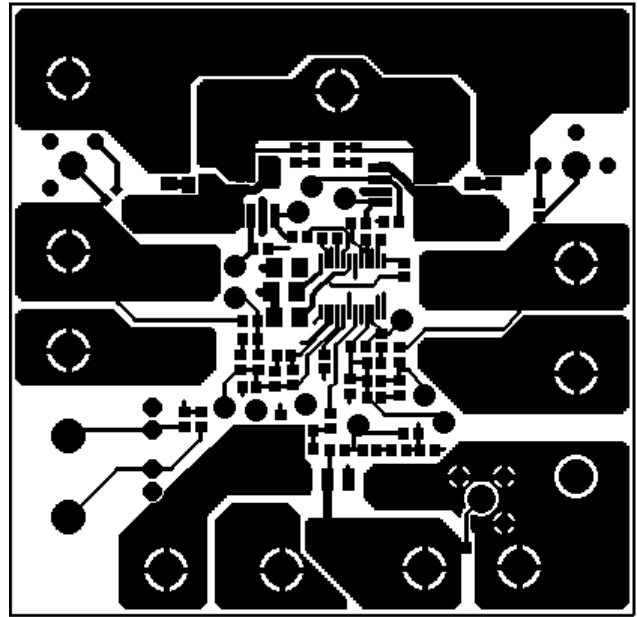

FIGURE 9. TOP LAYER

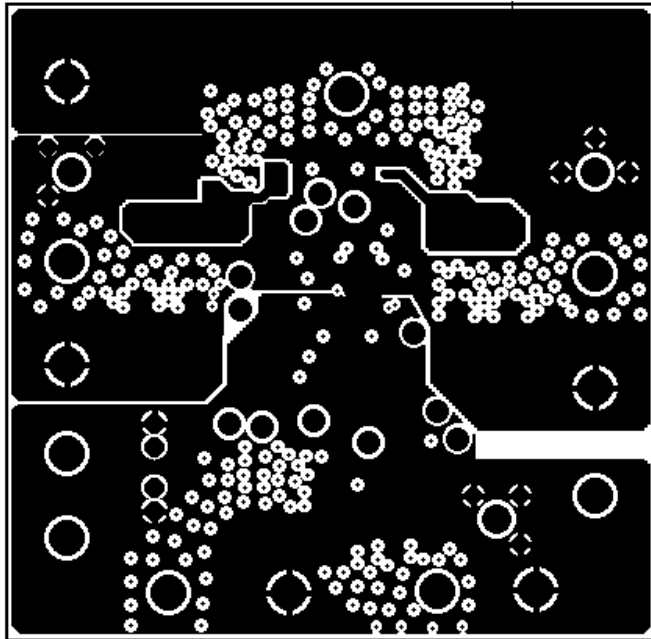

FIGURE 10. 2ND LAYER

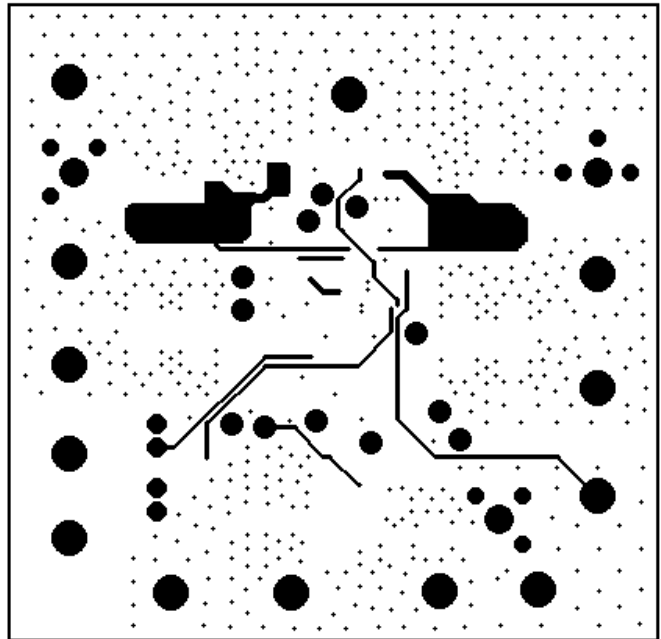

FIGURE 11. 3RD LAYER

# ISL6442EVAL1Z Board Layout (Continued)

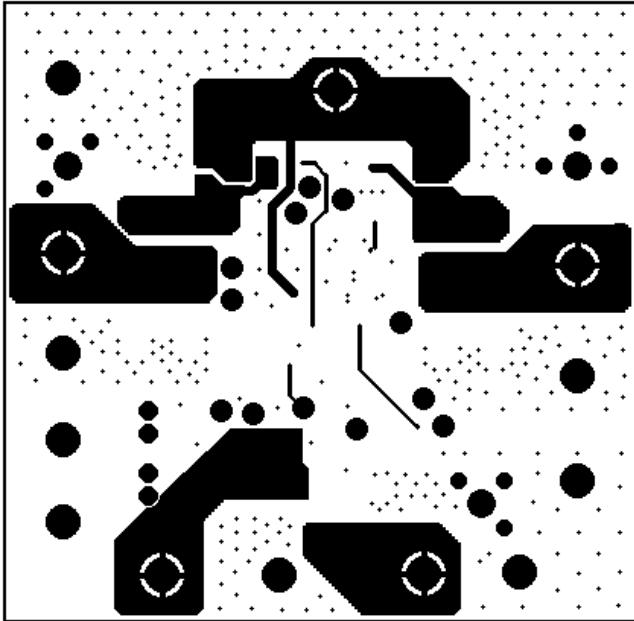

FIGURE 12. BOTTOM LAYER

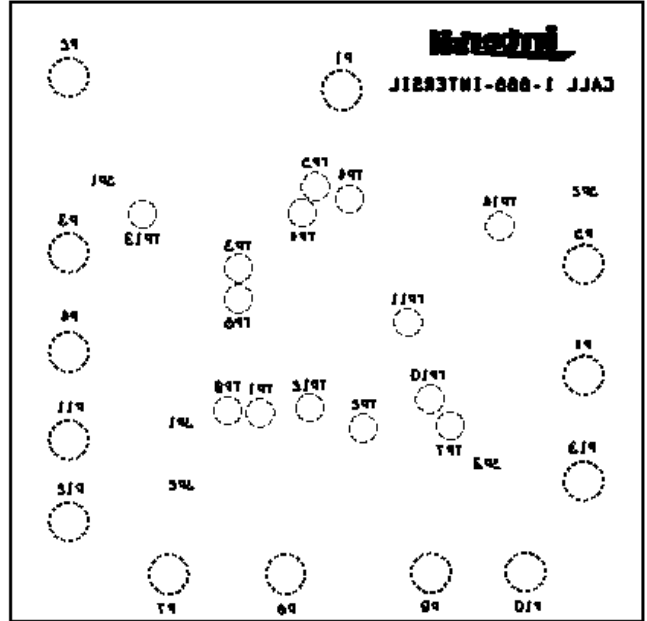

FIGURE 13. BOTTOM SILKSCREEN



## Notice

1. Descriptions of circuits, software and other related information in this document are provided only to illustrate the operation of semiconductor products and application examples. You are fully responsible for the incorporation or any other use of the circuits, software, and information in the design of your product or system. Renesas Electronics disclaims any and all liability for any losses and damages incurred by you or third parties arising from the use of these circuits, software, or information.
2. Renesas Electronics hereby expressly disclaims any warranties against and liability for infringement or any other claims involving patents, copyrights, or other intellectual property rights of third parties, by or arising from the use of Renesas Electronics products or technical information described in this document, including but not limited to, the product data, drawings, charts, programs, algorithms, and application examples.
3. No license, express, implied or otherwise, is granted hereby under any patents, copyrights or other intellectual property rights of Renesas Electronics or others.
4. You shall not alter, modify, copy, or reverse engineer any Renesas Electronics product, whether in whole or in part. Renesas Electronics disclaims any and all liability for any losses or damages incurred by you or third parties arising from such alteration, modification, copying or reverse engineering.
5. Renesas Electronics products are classified according to the following two quality grades: "Standard" and "High Quality". The intended applications for each Renesas Electronics product depends on the product's quality grade, as indicated below.  
"Standard": Computers; office equipment; communications equipment; test and measurement equipment; audio and visual equipment; home electronic appliances; machine tools; personal electronic equipment; industrial robots; etc.  
"High Quality": Transportation equipment (automobiles, trains, ships, etc.); traffic control (traffic lights); large-scale communication equipment; key financial terminal systems; safety control equipment; etc.  
Unless expressly designated as a high reliability product or a product for harsh environments in a Renesas Electronics data sheet or other Renesas Electronics document, Renesas Electronics products are not intended or authorized for use in products or systems that may pose a direct threat to human life or bodily injury (artificial life support devices or systems; surgical implantations; etc.), or may cause serious property damage (space system; undersea repeaters; nuclear power control systems; aircraft control systems; key plant systems; military equipment; etc.). Renesas Electronics disclaims any and all liability for any damages or losses incurred by you or any third parties arising from the use of any Renesas Electronics product that is inconsistent with any Renesas Electronics data sheet, user's manual or other Renesas Electronics document.
6. When using Renesas Electronics products, refer to the latest product information (data sheets, user's manuals, application notes, "General Notes for Handling and Using Semiconductor Devices" in the reliability handbook, etc.), and ensure that usage conditions are within the ranges specified by Renesas Electronics with respect to maximum ratings, operating power supply voltage range, heat dissipation characteristics, installation, etc. Renesas Electronics disclaims any and all liability for any malfunctions, failure or accident arising out of the use of Renesas Electronics products outside of such specified ranges.
7. Although Renesas Electronics endeavors to improve the quality and reliability of Renesas Electronics products, semiconductor products have specific characteristics, such as the occurrence of failure at a certain rate and malfunctions under certain use conditions. Unless designated as a high reliability product or a product for harsh environments in a Renesas Electronics data sheet or other Renesas Electronics document, Renesas Electronics products are not subject to radiation resistance design. You are responsible for implementing safety measures to guard against the possibility of bodily injury, injury or damage caused by fire, and/or danger to the public in the event of a failure or malfunction of Renesas Electronics products, such as safety design for hardware and software, including but not limited to redundancy, fire control and malfunction prevention, appropriate treatment for aging degradation or any other appropriate measures. Because the evaluation of microcomputer software alone is very difficult and impractical, you are responsible for evaluating the safety of the final products or systems manufactured by you.
8. Please contact a Renesas Electronics sales office for details as to environmental matters such as the environmental compatibility of each Renesas Electronics product. You are responsible for carefully and sufficiently investigating applicable laws and regulations that regulate the inclusion or use of controlled substances, including without limitation, the EU RoHS Directive, and using Renesas Electronics products in compliance with all these applicable laws and regulations. Renesas Electronics disclaims any and all liability for damages or losses occurring as a result of your noncompliance with applicable laws and regulations.
9. Renesas Electronics products and technologies shall not be used for or incorporated into any products or systems whose manufacture, use, or sale is prohibited under any applicable domestic or foreign laws or regulations. You shall comply with any applicable export control laws and regulations promulgated and administered by the governments of any countries asserting jurisdiction over the parties or transactions.
10. It is the responsibility of the buyer or distributor of Renesas Electronics products, or any other party who distributes, disposes of, or otherwise sells or transfers the product to a third party, to notify such third party in advance of the contents and conditions set forth in this document.
11. This document shall not be reprinted, reproduced or duplicated in any form, in whole or in part, without prior written consent of Renesas Electronics.
12. Please contact a Renesas Electronics sales office if you have any questions regarding the information contained in this document or Renesas Electronics products.  
(Note 1) "Renesas Electronics" as used in this document means Renesas Electronics Corporation and also includes its directly or indirectly controlled subsidiaries.  
(Note 2) "Renesas Electronics product(s)" means any product developed or manufactured by or for Renesas Electronics.

(Rev.4.0-1 November 2017)



### SALES OFFICES

Renesas Electronics Corporation

<http://www.renesas.com>

Refer to "<http://www.renesas.com/>" for the latest and detailed information.

**Renesas Electronics America Inc.**  
1001 Murphy Ranch Road, Milpitas, CA 95035, U.S.A.  
Tel: +1-408-432-8888, Fax: +1-408-434-5351

**Renesas Electronics Canada Limited**  
9251 Yonge Street, Suite 8309 Richmond Hill, Ontario Canada L4C 9T3  
Tel: +1-905-237-2004

**Renesas Electronics Europe Limited**  
Dukes Meadow, Millboard Road, Bourne End, Buckinghamshire, SL8 5FH, U.K  
Tel: +44-1628-651-700, Fax: +44-1628-651-804

**Renesas Electronics Europe GmbH**  
Arcadiastrasse 10, 40472 Düsseldorf, Germany  
Tel: +49-211-6503-0, Fax: +49-211-6503-1327

**Renesas Electronics (China) Co., Ltd.**  
Room 1709 Quantum Plaza, No.27 ZhichunLu, Haidian District, Beijing, 100191 P. R. China  
Tel: +86-10-8235-1155, Fax: +86-10-8235-7679

**Renesas Electronics (Shanghai) Co., Ltd.**  
Unit 301, Tower A, Central Towers, 555 Langao Road, Putuo District, Shanghai, 200333 P. R. China  
Tel: +86-21-2226-0888, Fax: +86-21-2226-0999

**Renesas Electronics Hong Kong Limited**  
Unit 1601-1611, 16/F., Tower 2, Grand Century Place, 193 Prince Edward Road West, Mongkok, Kowloon, Hong Kong  
Tel: +852-2265-6688, Fax: +852-2886-9022

**Renesas Electronics Taiwan Co., Ltd.**  
13F, No. 363, Fu Shing North Road, Taipei 10543, Taiwan  
Tel: +886-2-8175-9600, Fax: +886-2-8175-9670

**Renesas Electronics Singapore Pte. Ltd.**  
80 Bendemeer Road, Unit #06-02 Hyflux Innovation Centre, Singapore 339949  
Tel: +65-6213-0200, Fax: +65-6213-0300

**Renesas Electronics Malaysia Sdn.Bhd.**  
Unit 1207, Block B, Menara Amcorp, Amcorp Trade Centre, No. 18, Jln Persiaran Barat, 46050 Petaling Jaya, Selangor Darul Ehsan, Malaysia  
Tel: +60-3-7955-9390, Fax: +60-3-7955-9510

**Renesas Electronics India Pvt. Ltd.**  
No.777C, 100 Feet Road, HAL 2nd Stage, Indiranagar, Bangalore 560 038, India  
Tel: +91-80-67208700, Fax: +91-80-67208777

**Renesas Electronics Korea Co., Ltd.**  
17F, KAMCO Yangjae Tower, 262, Gangnam-daero, Gangnam-gu, Seoul, 06265 Korea  
Tel: +82-2-558-3737, Fax: +82-2-558-5338

# Mouser Electronics

Authorized Distributor

Click to View Pricing, Inventory, Delivery & Lifecycle Information:

[Renesas Electronics:](#)

[ISL6442EVAL1Z](#)