

CMKD6000

**SURFACE MOUNT SILICON  
DUAL PAIR, IN SERIES  
ULTRA LOW LEAKAGE  
SWITCHING DIODE**



[www.centrasemi.com](http://www.centrasemi.com)

**DESCRIPTION:**

The CENTRAL SEMICONDUCTOR CMKD6000 consists of two pair of electrically isolated, series configured Ultra Low Leakage Switching Diodes manufactured by the epitaxial planar process, epoxy molded in an SOT-363 surface mount package.

**MARKING CODE: CK0**

**APPLICATIONS:**

- Handheld Medical Devices
- Battery Operated Equipment
- High Speed Data Line Steering

**FEATURES:**

- Low Total Conduction Losses

**MAXIMUM RATINGS:** ( $T_A=25^\circ\text{C}$ )

Continuous Reverse Voltage
Peak Repetitive Reverse Voltage
Continuous Forward Current
Peak Repetitive Forward Current
Peak Forward Surge Current, $t_p=1.0\mu\text{s}$
Peak Forward Surge Current, $t_p=1.0\text{s}$
Power Dissipation
Operating and Storage Junction Temperature
Thermal Resistance

**SYMBOL**

$V_R$	75
$V_{RRM}$	100
$I_F$	250
$I_{FRM}$	500
$I_{FSM}$	4.0
$I_{FSM}$	1.0
$P_D$	250
$T_J, T_{stg}$	-65 to +150
$\theta_{JA}$	500

**UNITS**

V
V
mA
mA
A
A
mW
$^\circ\text{C}$
$^\circ\text{C/W}$

**ELECTRICAL CHARACTERISTICS PER DIODE:** ( $T_A=25^\circ\text{C}$  unless otherwise noted)

SYMBOL	TEST CONDITIONS	MIN	TYP	MAX	UNITS
$I_R$	$V_R=75\text{V}$		35	500	pA
$I_R$	$V_R=5.0, T_A=50^\circ\text{C}$		10	100	pA
$BV_R$	$I_R=100\mu\text{A}$	100	120		V
$V_F$	$I_F=1.0\text{mA}$		0.77	0.85	V
$V_F$	$I_F=10\text{mA}$		0.85	0.95	V
$V_F$	$I_F=100\text{mA}$		0.96	1.1	V
$C_J$	$V_R=0, f=1.0\text{MHz}$		1.7	2.0	pF
$t_{rr}$	$I_R=I_F=10\text{mA}, I_{rr}=1.0\text{mA}, R_L=100\Omega$			3.0	$\mu\text{s}$

CMKD6000

SURFACE MOUNT SILICON  
DUAL PAIR, IN SERIES  
ULTRA LOW LEAKAGE  
SWITCHING DIODE



SOT-363 CASE - MECHANICAL OUTLINE

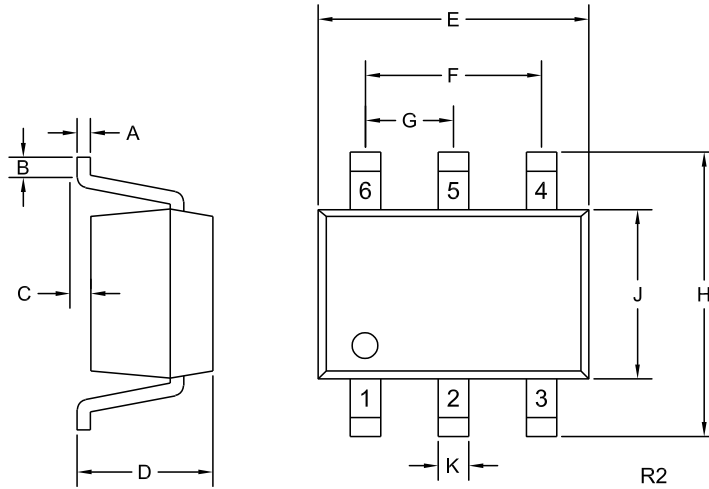

PIN CONFIGURATION

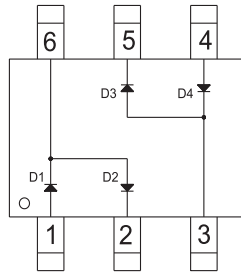

SYMBOL	INCHES		MILLIMETERS	
	MIN	MAX	MIN	MAX
A	0.004	0.010	0.10	0.25
B	0.005	-	0.12	-
C	0.000	0.004	0.00	0.10
D	0.031	0.043	0.80	1.10
E	0.071	0.087	1.80	2.20
F	0.051		1.30	
G	0.026		0.65	
H	0.075	0.091	1.90	2.30
J	0.043	0.055	1.10	1.40
K	0.006	0.012	0.15	0.30

SOT-363 (REV: R2)

LEAD CODE:

- 1) Anode D1
- 2) Cathode D2
- 3) Anode D3, Cathode D4
- 4) Anode D4
- 5) Cathode D3
- 6) Cathode D1, Anode D2

MARKING CODE: CK0

R2 (26-February 2016)

CMKD6000

SURFACE MOUNT SILICON  
DUAL PAIR, IN SERIES  
ULTRA LOW LEAKAGE  
SWITCHING DIODE



TYPICAL ELECTRICAL CHARACTERISTICS

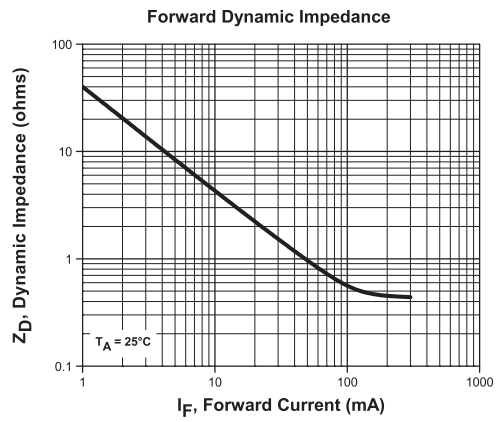
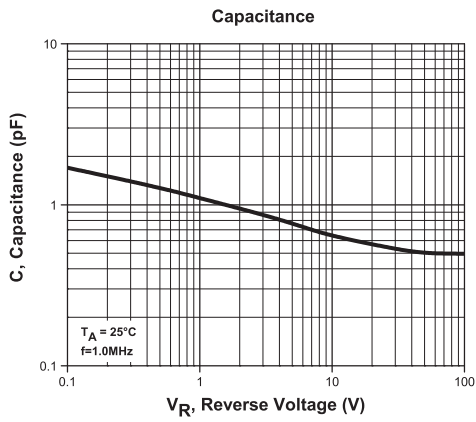
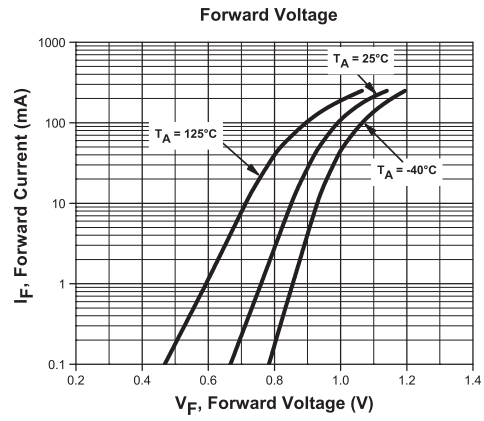
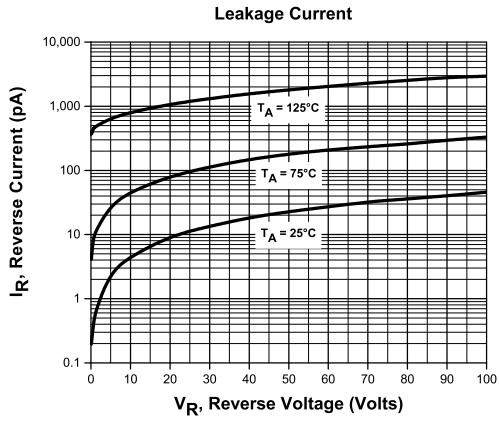

R2 (26-February 2016)

CMKD6000

SURFACE MOUNT SILICON  
DUAL PAIR, IN SERIES  
ULTRA LOW LEAKAGE  
SWITCHING DIODE



TYPICAL ELECTRICAL CHARACTERISTICS

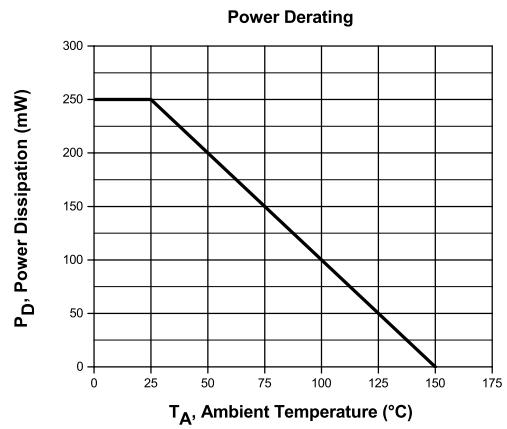
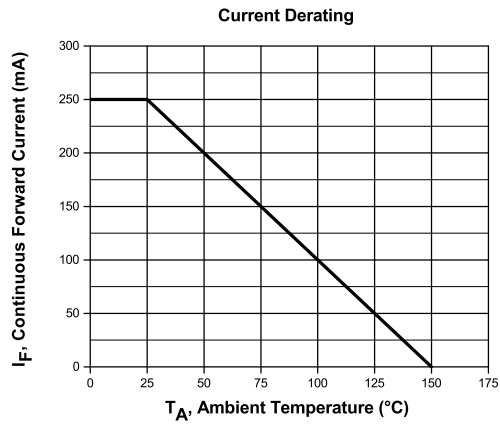

R2 (26-February 2016)

## OUTSTANDING SUPPORT AND SUPERIOR SERVICES



---

### PRODUCT SUPPORT

Central's operations team provides the highest level of support to insure product is delivered on-time.

- Supply management (Customer portals)
- Inventory bonding
- Consolidated shipping options
- Custom bar coding for shipments
- Custom product packing

---

### DESIGNER SUPPORT/SERVICES

Central's applications engineering team is ready to discuss your design challenges. Just ask.

- Free quick ship samples (2<sup>nd</sup> day air)
- Online technical data and parametric search
- SPICE models
- Custom electrical curves
- Environmental regulation compliance
- Customer specific screening
- Up-screening capabilities
- Special wafer diffusions
- PbSn plating options
- Package details
- Application notes
- Application and design sample kits
- Custom product and package development

---

### REQUESTING PRODUCT PLATING

1. If requesting Tin/Lead plated devices, add the suffix " TIN/LEAD" to the part number when ordering (example: 2N2222A TIN/LEAD).
2. If requesting Lead (Pb) Free plated devices, add the suffix " PBFREE" to the part number when ordering (example: 2N2222A PBFREE).

---

### CONTACT US

#### Corporate Headquarters & Customer Support Team

Central Semiconductor Corp.  
145 Adams Avenue  
Hauppauge, NY 11788 USA  
Main Tel: (631) 435-1110  
Main Fax: (631) 435-1824  
Support Team Fax: (631) 435-3388  
[www.centrasemi.com](http://www.centrasemi.com)

**Worldwide Field Representatives:**  
[www.centrasemi.com/wwreps](http://www.centrasemi.com/wwreps)

**Worldwide Distributors:**  
[www.centrasemi.com/wwdistributors](http://www.centrasemi.com/wwdistributors)

---

For the latest version of Central Semiconductor's **LIMITATIONS AND DAMAGES DISCLAIMER**, which is part of Central's Standard Terms and Conditions of sale, visit: [www.centrasemi.com/terms](http://www.centrasemi.com/terms)

# Mouser Electronics

Authorized Distributor

Click to View Pricing, Inventory, Delivery & Lifecycle Information:

[Central Semiconductor:](#)

[CMKD6000 TR](#)