

HSME-CA83

Mono-Color Top Mount ChipLED

Description

The Broadcom[®] HSME-CA83 is a top-view mono-color surface-mount yellow-green LED that comes in one of the industry's smallest 0402 (1005) footprints.

Its small package size of 1.0 x 0.5 mm² and low package height of 0.20 mm makes this product easy to use. The small form factor offers great design flexibility for use in applications such as wearable and portable consumer electronics that have space and headroom constraints.

This product utilizes efficient and high-performance Aluminum Indium Gallium Phosphide (AlInGaP) LED die technology. The LEDs are packed in tape and reel form that is compatible with industry-standard automatic machine placement and reflow soldering.

Features

- Small package size
- Low profile
- 0402 industry-standard footprint
- Compatible with IR reflow soldering
- Available in 8-mm tape and 7-in. diameter reel

Applications

- Status indicator
- Keypad backlighting
- Push button backlighting

CAUTION! This LED is Class 1A ESD sensitive per ANSI/ESDA/JEDEC JS-001. Please observe appropriate precautions during handling and processing. Refer to Application Note AN-1142 for additional details.

Figure 1: Package Dimensions

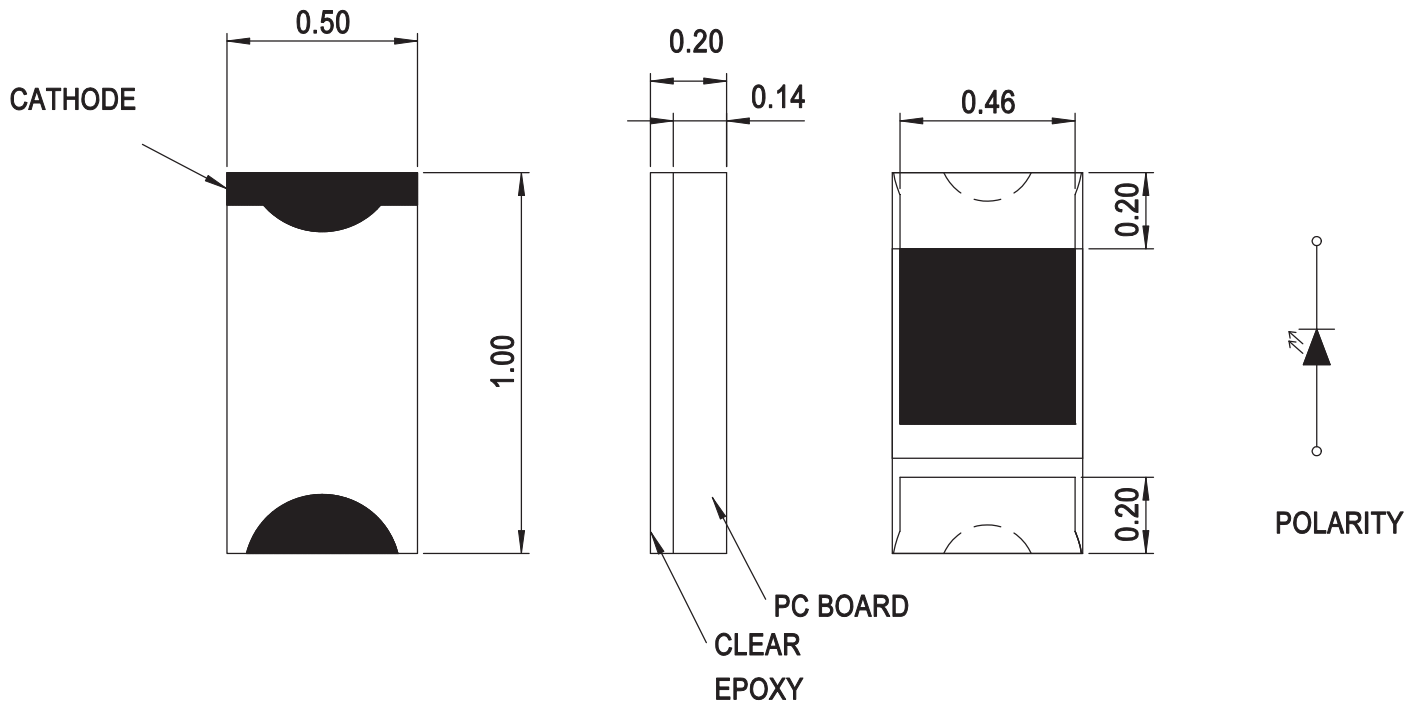

NOTE:

1. All dimensions are in millimeters (mm).
2. Tolerance is ± 0.10 mm unless otherwise specified.
3. Maximum package height is 0.28 mm.

Absolute Maximum Ratings

Parameters	Rating	Unit
DC Forward Current ^a	30	mA
Power Dissipation	72	mW
LED Junction Temperature	95	°C
Operating/Storage Temperature Range	-40 to +85	°C

a. Derate linearly as shown in [Figure 6](#).

Optical Characteristics ($T_J = 25^\circ\text{C}$, $I_F = 20\text{ mA}$)

Color	Luminous Intensity I_V (mcd) ^a		Dominant Wavelength λ_d (nm) ^b	Peak Wavelength λ_p (nm)	Viewing Angle $2\theta_{1/2}$ (Degrees) ^c
	Min.	Max.	Typ. ^d	Typ. ^d	Typ. ^d
Yellow-Green	28.5	112.5	572	570	140

- The luminous intensity, I_V , is measured at the mechanical axis of the package and is tested with a single-current pulse condition. The actual peak of the spatial radiation pattern may not be aligned with the axis.
- The dominant wavelength, λ_d , is derived from the CIE Chromaticity Diagram and represents the perceived color of the device.
- $\theta_{1/2}$ is the off axis angle where the luminous intensity is $1/2$ the peak intensity.
- Typ. value is for reference only.

Electrical Characteristics ($T_J = 25^\circ\text{C}$, $I_F = 20\text{ mA}$)

Color	Forward Voltage V_F (V) ^a		Reverse Current I_R (μA) at $V_R = 5\text{V}$ ^b	Thermal Resistance $R\theta_{J-S}$ ($^\circ\text{C}/\text{W}$) ^c
	Min.	Max.	Max.	Typ. ^d
Yellow-Green	1.6	2.4	10	300

- Forward voltage tolerance is $\pm 0.1\text{V}$.
- Indicates product final test condition. Long-term reverse bias is not recommended.
- Thermal resistance from LED junction to solder point.
- Typ. value is for reference only.

Bin Information

Intensity Bin Limits (CAT)

Bin ID	Luminous Intensity (mcd)	
	Min.	Max.
N	28.50	45.00
P	45.00	71.50
Q	71.50	112.50

Tolerance = $\pm 15\%$

Color Bin Limits (BIN)

Bin ID	Dominant Wavelength (nm)	
	Min.	Max.
A	561.5	564.5
B	564.5	567.5
C	567.5	570.5
D	570.5	573.5
E	573.5	576.5

Tolerance = ± 1.0 nm

Figure 2: Spectral Power Distribution

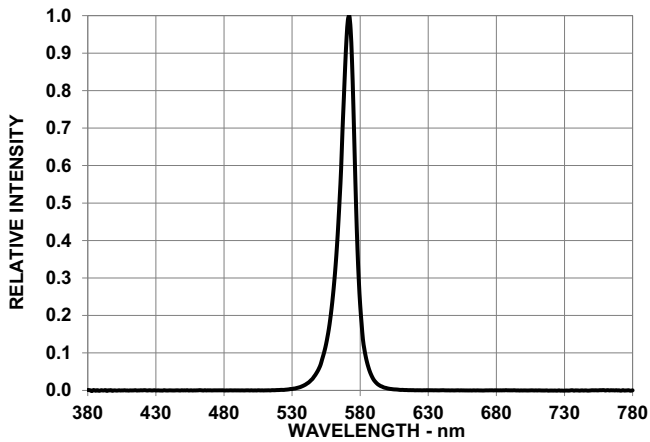

Figure 3: Forward Current vs. Forward Voltage

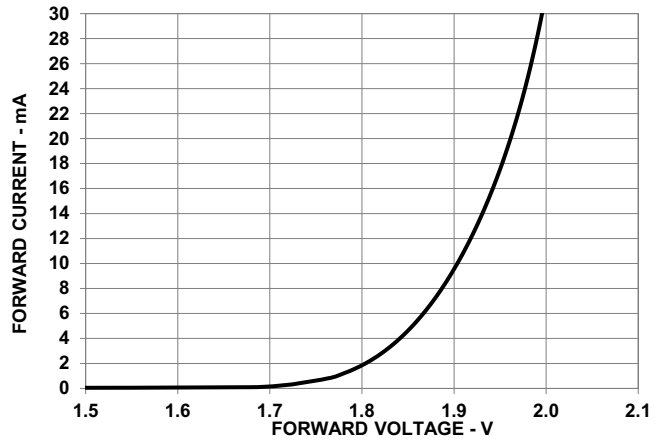

Figure 4: Relative Luminous Intensity vs. Forward Current

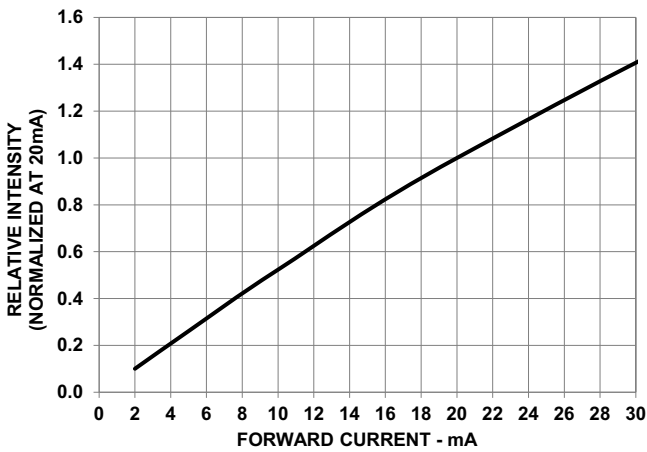

Figure 5: Radiation Pattern

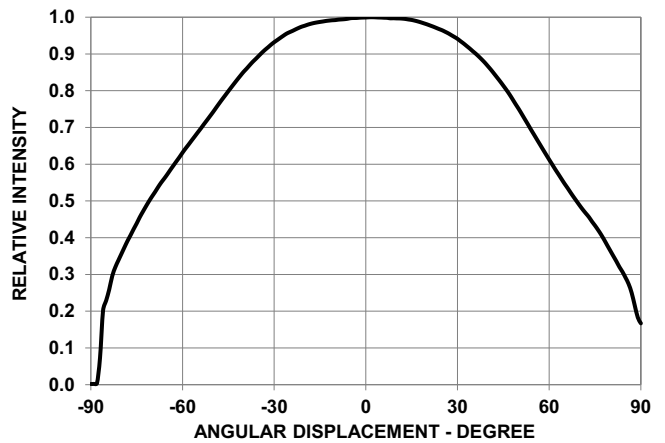

Figure 6: Derating Curve

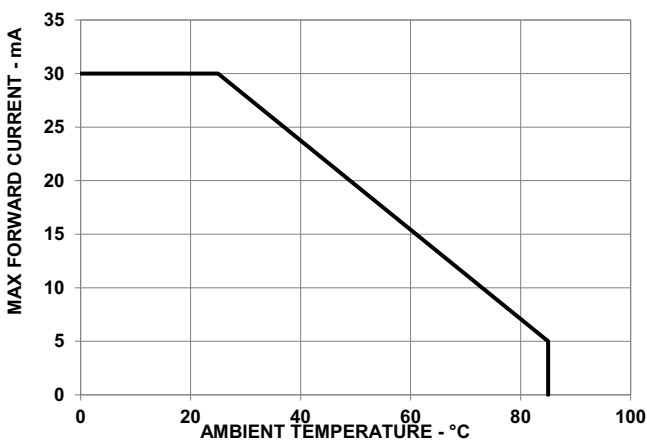
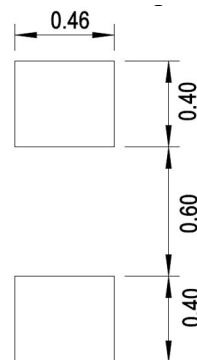

Figure 7: Recommended Soldering Land Pattern



Precautionary Notes

Soldering

- Do not perform reflow soldering more than twice. Observe necessary precautions of handling moisture-sensitive devices as stated in the following section.
- Do not apply any pressure or force on the LED during reflow and after reflow when the LED is still hot.
- Use reflow soldering to solder the LED. Use hand soldering only for rework if unavoidable, but it must be strictly controlled to the following conditions:
 - Soldering iron tip temperature = 310°C maximum
 - Soldering duration = 2 seconds maximum
 - Number of cycles = 1 only
 - Power of soldering iron = 50W maximum
- Do not touch the LED package body with the soldering iron except for the soldering terminals, as it may cause damage to the LED.
- Confirm beforehand whether the functionality and performance of the LED is affected by soldering with hand soldering.

Figure 10: Recommended Lead-Free Reflow Soldering Profile

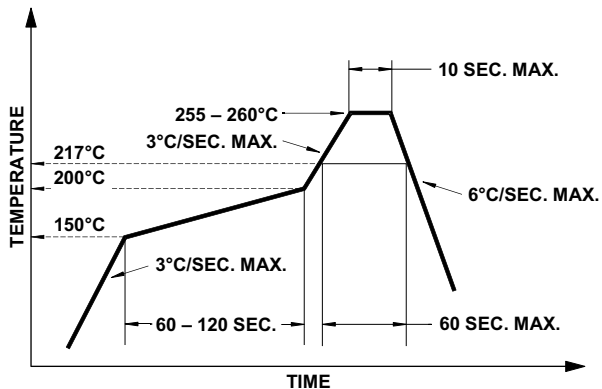

Handling Precautions

This product has a Moisture Sensitive Level 2a rating per JEDEC J-STD-020. Refer to Broadcom Application Note AN5305, *Handling of Moisture Sensitive Surface Mount Devices*, for additional details and a review of proper handling procedures.

- Before use:
 - An unopened moisture barrier bag (MBB) can be stored at <40°C/90% RH for 12 months. If the actual shelf life has exceeded 12 months and the Humidity Indicator Card (HIC) indicates that baking is not required, then it is safe to reflow the LEDs per the original MSL rating.
 - Do not open the MBB prior to assembly (for example, for IQC). If unavoidable, MBB must be properly resealed with fresh desiccant and HIC. The exposed duration must be taken in as floor life.
- Control after opening the MBB:
 - Read the HIC immediately upon opening of MBB.
 - Keep the LEDs at <30°/60% RH at all times, and complete all high temperature-related processes, including soldering, curing or rework within 672 hours.
- Control for unfinished reel:
 - Store unused LEDs in a sealed MBB with desiccant or a desiccator at <5% RH.
- Control of assembled boards:
 - If the PCB soldered with the LEDs is to be subjected to other high-temperature processes, store the PCB in a sealed MBB with desiccant or desiccator at <5% RH to ensure that all LEDs have not exceeded their floor life of 672 hours.
- Baking is required if:
 - The HIC indicator indicates a change in color for 10% and 5%, as stated on the HIC.
 - The LEDs are exposed to conditions of >30°C/60% RH at any time.
 - The LED's floor life exceeded 672 hours.

The recommended baking condition is 60°C ± 5°C for 20 hours.

Baking can only be done once.

Application Precautions

- The drive current of the LED must not exceed the maximum allowable limit across temperature as stated in the data sheet. Constant current driving is recommended to ensure consistent performance.
- Circuit design must cater to the whole range of forward voltage (V_F) of the LEDs to ensure the intended drive current can always be achieved.
- The LED exhibits slightly different characteristics at different drive currents, which may result in a larger variation of performance (meaning: intensity, wavelength, and forward voltage). Set the application current as close as possible to the test current to minimize these variations.
- Driving the LED at low current (< 2 mA) will not cause functional failures to the LED (i.e. open/short). However, the variation in intensity will be larger than existing intensity bin ratio of 1:1.6.
- If the LED is intended to be used along with LED of other color to achieve color mixing, Broadcom does not guarantee the consistency of the resultant color. Contact your Broadcom Sales Representative for such applications.
- The LED is not intended for reverse bias. Use other appropriate components for such purposes. When driving the LED in matrix form, ensure that the reverse bias voltage does not exceed the allowable limit of the LED.
- Avoid rapid change in ambient temperature, especially in high-humidity environments, because they cause condensation on the LED.
- If the LED is intended to be used in a harsh or outdoor environment, protect the LED against damages caused by rain water, water, dust, oil, corrosive gases, external mechanical stresses, and so on.

Eye Safety Precautions

LEDs may pose optical hazards when in operation. Do not look directly at operating LEDs because it might be harmful to the eyes. For safety reasons, use appropriate shielding or personal protective equipment.

Disclaimer

Broadcom's products and software are not specifically designed, manufactured, or authorized for sale as parts, components, or assemblies for the planning, construction, maintenance, or direct operation of a nuclear facility or for use in medical devices or applications. The customer is solely responsible, and waives all rights to make claims against Broadcom or its suppliers, for all loss, damage, expense, or liability in connection with such use.

Copyright © 2022 Broadcom. All Rights Reserved. The term "Broadcom" refers to Broadcom Inc. and/or its subsidiaries. For more information, go to www.broadcom.com. All trademarks, trade names, service marks, and logos referenced herein belong to their respective companies.

Broadcom reserves the right to make changes without further notice to any products or data herein to improve reliability, function, or design. Information furnished by Broadcom is believed to be accurate and reliable. However, Broadcom does not assume any liability arising out of the application or use of this information, nor the application or use of any product or circuit described herein, neither does it convey any license under its patent rights nor the rights of others.



Mouser Electronics

Authorized Distributor

Click to View Pricing, Inventory, Delivery & Lifecycle Information:

[Broadcom Limited:](#)

[HSME-CA83](#) [HSME-C280](#)