



## Ultra-small 22 mΩ 4 A Load Switch with Discharge and Reverse Current Blocking

### General Description

The SLG59M610V is a 22 mΩ 4 A single-channel load switch that is able to switch 1 to 5 V power rails. The product is packaged in an ultra-small 1.5 x 2.0 mm package.

### Features

- 1.5 x 2.0 mm FC-TDFN 8L package (2 fused pins for drain and 2 fused pins for source)
- Logic level ON pin capable of supporting 0.85 V CMOS Logic
- User selectable ramp rate with external capacitor
- 22 mΩ RDS<sub>ON</sub> while supporting 4 A
- Two Over Current Protection Modes
  - Short Circuit Current Limit
  - Active Current Limit
- Over Temperature Protection
- Pb-Free / Halogen-Free / RoHS compliant
- Operating Temperature: -40 °C to 85°C
- Operating Voltage: 2.5 V to 5.5 V

### Pin Configuration

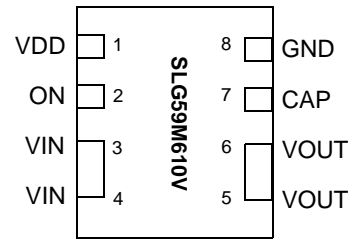

**8-pin FC-TDFN (Top View)**

### Applications

- Notebook Power Rail Switching
- Tablet Power Rail Switching
- Smartphone Power Rail Switching

### Block Diagram

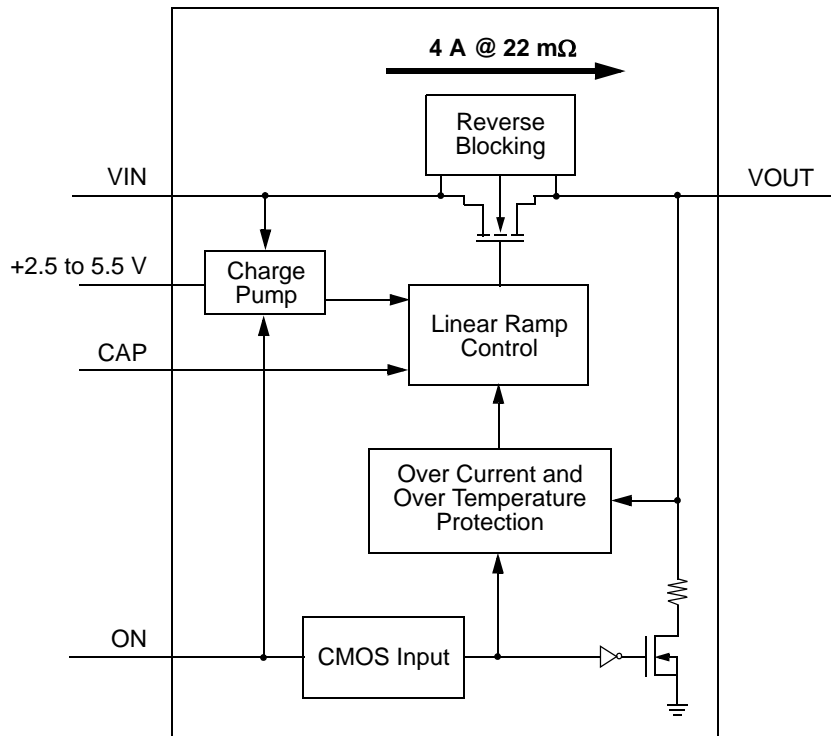



### Pin Description

Pin #	Pin Name	Type	Pin Description
1	VDD	PWR	VDD power for load switch control (2.5 V to 5.5 V)
2	ON	Input	Turns MOSFET ON (4 M $\Omega$ pull down resistor) CMOS input with VIL < 0.3 V, VIH > 0.85 V
3	VIN	MOSFET	Drain of Power MOSFET (fused with pin 4)
4	VIN	MOSFET	Drain of Power MOSFET (fused with pin 3)
5	VOUT	MOSFET	Source of Power MOSFET (fused with pin 6)
6	VOUT	MOSFET	Source of Power MOSFET (fused with pin 5)
7	CAP	Input	Capacitor for controlling power rail ramp rate
8	GND	GND	Ground

### Ordering Information

Part Number	Type	Production Flow
SLG59M610V	FC-TDFN 8L	Industrial, -40 °C to 85 °C
SLG59M610VTR	FC-TDFN 8L (Tape and Reel)	Industrial, -40 °C to 85 °C



## Absolute Maximum Ratings

Parameter	Description	Conditions	Min.	Typ.	Max.	Unit
$V_{DD}$	Power Supply		--	--	7	V
$T_S$	Storage Temperature		-65	--	150	°C
$ESD_{HBM}$	ESD Protection	Human Body Model	2000	--	--	V
$W_{DIS}$	Package Power Dissipation		--	--	1	W
MOSFET $IDS_{PK}$	Peak Current from Drain to Source	For no more than 1 ms with 1% duty cycle	--	--	6	A

Note: Stresses greater than those listed under "Absolute Maximum Ratings" may cause permanent damage to the device. This is a stress rating only and functional operation of the device at these or any other conditions above those indicated in the operational sections of this specification is not implied. Exposure to absolute maximum rating conditions for extended periods may affect reliability.

## Electrical Characteristics

$T_A = -40\text{ °C to }85\text{ °C}$  (unless otherwise stated)

Parameter	Description	Conditions	Min.	Typ.	Max.	Unit
$V_{DD}$	Power Supply Voltage	-40 °C to 85°C	2.5	--	5.5	V
$I_{DD}$	Power Supply Current (PIN 1)	when OFF	--	--	1	μA
		when ON, No load	--	70	100	μA
$RDS_{ON}$	Static Drain to Source ON Resistance	$T_A$ 25°C @ 100 mA	--	22	28	mΩ
		$T_A$ 70°C @ 100 mA	--	25	30	mΩ
		$T_A$ 85°C @ 100 mA	--	27	31	mΩ
$IDS$	Operating Current	$V_{IN} = 1.0\text{ V to }5.5\text{ V}$	--	--	4	A
$V_{IN}$	Drain Voltage		1.0	--	$V_{DD}$	V
$T_{ON\_Delay}$	ON pin Delay Time	50% ON to Ramp Begin	0	300	500	μs
$T_{Total\_ON}$	Total Turn On Time	50% ON to 90% $V_{OUT}$	Configurable <sup>1</sup>			ms
		Example: CAP (PIN 7) = 4 nF, $V_{DD} = V_{IN} = 5\text{ V}$ , Source_Cap = 10 μF, $IDS = 100\text{ mA}$	--	1.96	--	ms
$T_{SLEWRATE}$	Slew Rate	10% $V_S$ to 90% $V_S$	Configurable <sup>1</sup>			V/ms
		Example: CAP (PIN 7) = 4 nF, $V_{DD} = V_{IN} = 5\text{ V}$ , Source_Cap = 10 μF, $IDS = 100\text{ mA}$	--	3.0	--	V/ms
$I_{REVERSE}$	Reverse Blocking Current	$V_{OUT} = 5.0$ , $V_{IN} = 0\text{ V}$ ; $V_{DD} = 0\text{ V}$ ; $ON = 0\text{ V}$	--	0.5	2	μA
$CAP_{SOURCE}$	Source Cap	Source to GND	--	--	500	μF
$R_{DIS}$	Discharge Resistance		100	150	300	Ω
$ON\_V_{IH}$	High Input Voltage on ON pin		0.85	--	$V_{DD}$	V
$ON\_V_{IL}$	Low Input Voltage on ON pin		-0.3	0	0.3	V
$I_{LIMIT}$	Active Current Limit	MOSFET will automatically limit current when $V_S > 250\text{ mV}$	--	6.0	--	A
	Short Circuit Current Limit	MOSFET will automatically limit current when $V_S < 250\text{ mV}$	--	0.5	--	A
$THERM_{ON}$	Thermal shutoff turn-on temperature		--	125	--	°C
$THERM_{OFF}$	Thermal shutoff turn-off temperature		--	100	--	°C
$THERM_{TIME}$	Thermal shutoff time		--	--	1	ms
$T_{OFF\_Delay}$	OFF Delay Time	50% ON to $V_{OUT}$ Fall, $V_{DD} = V_{IN} = 5\text{ V}$	--	7.5	15	μs

Notes:  
1. Refer to table for configuration details.



### SLG59M610V Turn ON

The normal power on sequence is first VDD, with VD only being applied after VDD is > 1 V, and then ON after VD is at least 90% of final value. The normal power off sequence is the power on sequence in reverse.

If VDD and VD are turned on at the same time then it is possible that a voltage glitch will appear on VS before VDD achieves 1V which is the  $V_T$  of the main MOSFET. The size of the glitch is dependent on source and drain capacitance loading and the ramp rate of VDD & VD. The glitch can be eliminated with at least 10  $\mu$ F of capacitance on VS.

The VS ramp follows a linear path, not an RC limitation provided the ramp is slow enough to not be current limited by load capacitance.

### SLG59M610V Current Limiting

The SLG59M610V has two modes of current limiting, differentiated by the output (Source pin) voltage.

#### 1. Standard Current Limiting Mode (with Thermal Protection)

When  $V(S) > 250$  mV, the output current is initially limited to the Active Current Limit specification given in the Electrical Characteristics table. The current limiting circuit is very fast and responds within a few micro-seconds to sudden loads. When overload is sensed, the current limiting circuit increases the FET resistance to keep the current from exceeding the Active Current Limit.

However, if an overload condition persists, the die temperature rise due to the increased FET resistance while at maximum current can activate Thermal Protection. If the die temperature exceeds the  $THERM_{ON}$  specification, the FET is shut completely OFF, allowing the die to cool. When the die cools to the  $THERM_{OFF}$  temperature, the FET is allowed to turn back on. This process may repeat as long as the overload condition is present.

#### 2. Short Circuit Current Limiting Mode (with Thermal Protection)

When  $V(S) < 250$  mV (which is the case with a hard short, such as a solder bridge on the power rail), the current is limited to approximately 500 mA. Thermal Protection is also present, but since the Short Circuit Current Limit is much lower than Standard Current Limit, activation may only occur at higher ambient temperatures.

### Reverse Current Blocking Protection Operation

In the SLG59M610V, reverse current blocking is active only when ON = Low. Thus if ON = High, current may flow in both directions even if external  $V_{OUT} > V_{IN}$  is suddenly applied. Once ON = Low, the SLG59M610V will block reverse current from VOUT to VIN.

For more information about Reverse Current Blocking operation and other Silego GreenFET features please visit our [Application Notes](#) page at our website and see App Note "AN-1068 GreenFET3 Integrated Power Switch Basics".



### $T_{Total\_ON}$ vs. CAP @ $V_{DD} = 3.3\text{ V}$

SLG59M610V  $T_{Total\_ON}$ : ON (50%) -  $V_{OUT}$  (90%)  
 $V_{DD} = 3.3\text{ V}$ ,  $T_A = 25\text{ }^\circ\text{C}$ .  $C_L = 10\text{ }\mu\text{F}$ ,  $I_{DS} = 100\text{ mA}$

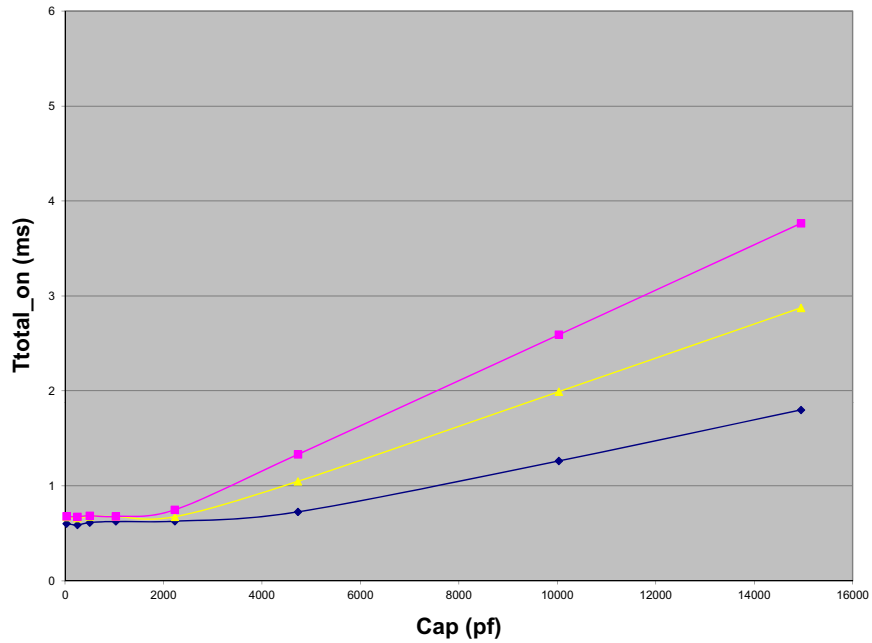

### $T_{Total\_ON}$ vs. CAP @ $V_{DD} = 5.0\text{ V}$

SLG59M610V  $T_{Total\_ON}$ : ON (50%) -  $V_{OUT}$  (90%)  
 $V_{DD} = 5.0\text{ V}$ ,  $T_A = 25\text{ }^\circ\text{C}$ .  $C_L = 10\text{ }\mu\text{F}$ ,  $I_{DS} = 100\text{ mA}$

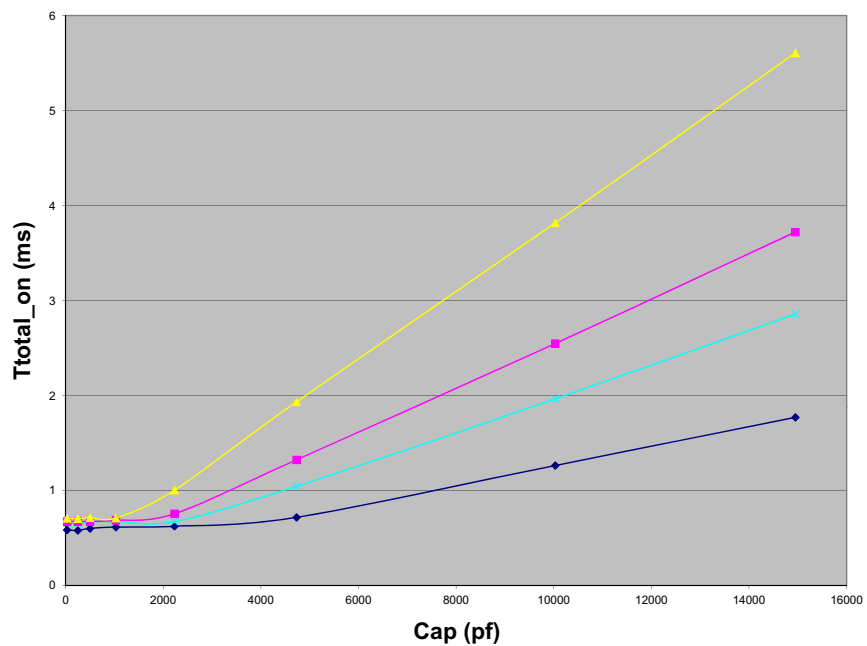



### $T_{SLEW}$ vs. CAP @ $V_{DD} = 3.3\text{ V}$

SLG59M610V  $T_{SLEW}$ :  $V_{OUT}(10\%) - V_{OUT}(90\%)$   
 $V_{DD} = 3.3\text{ V}$ ,  $T_A = 25\text{ }^\circ\text{C}$ ,  $C_L = 10\text{ }\mu\text{F}$ ,  $I_{DS} = 100\text{ mA}$

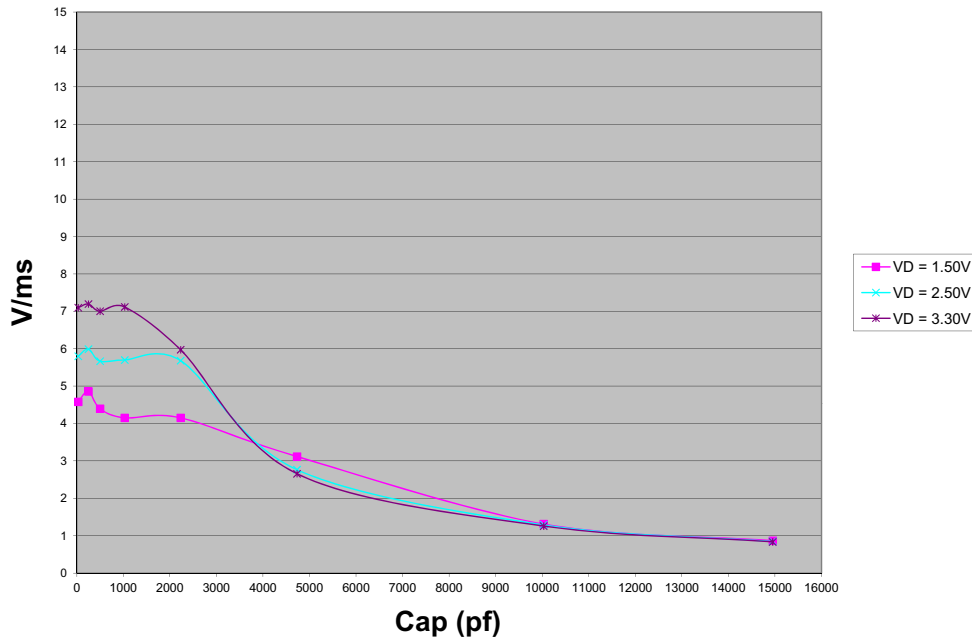

### $T_{SLEW}$ vs. CAP @ $V_{DD} = 5.0\text{ V}$

SLG59M610V  $T_{SLEW}$ :  $V_{OUT}(10\%) - V_{OUT}(90\%)$   
 $V_{DD} = 5.0\text{ V}$ ,  $T_A = 25\text{ }^\circ\text{C}$ ,  $C_L = 10\text{ }\mu\text{F}$ ,  $I_{DS} = 100\text{ mA}$

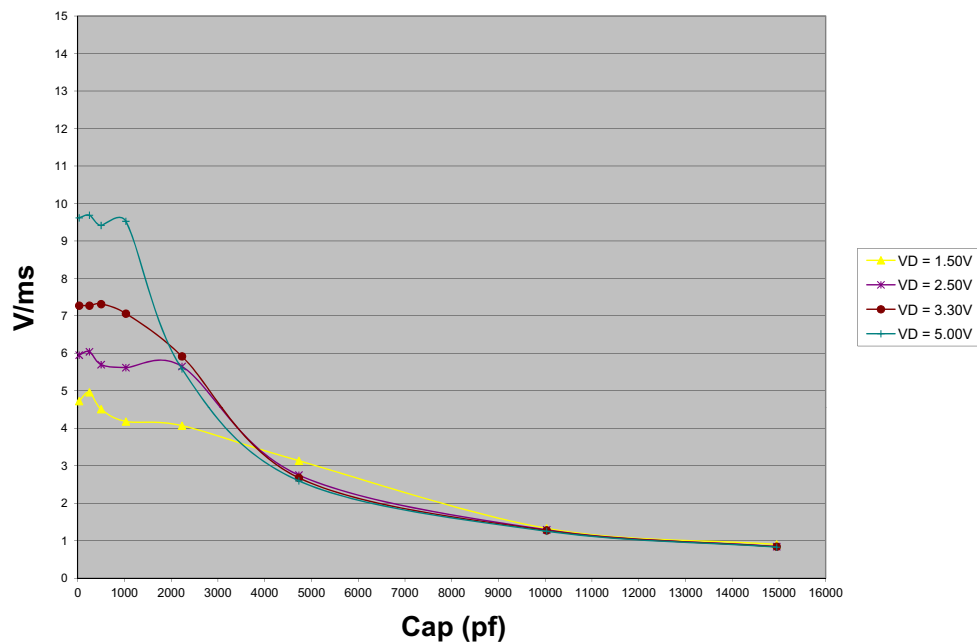



### $T_{Total\_ON}$ , $T_{ON\_Delay}$ and Slew Rate Measurement

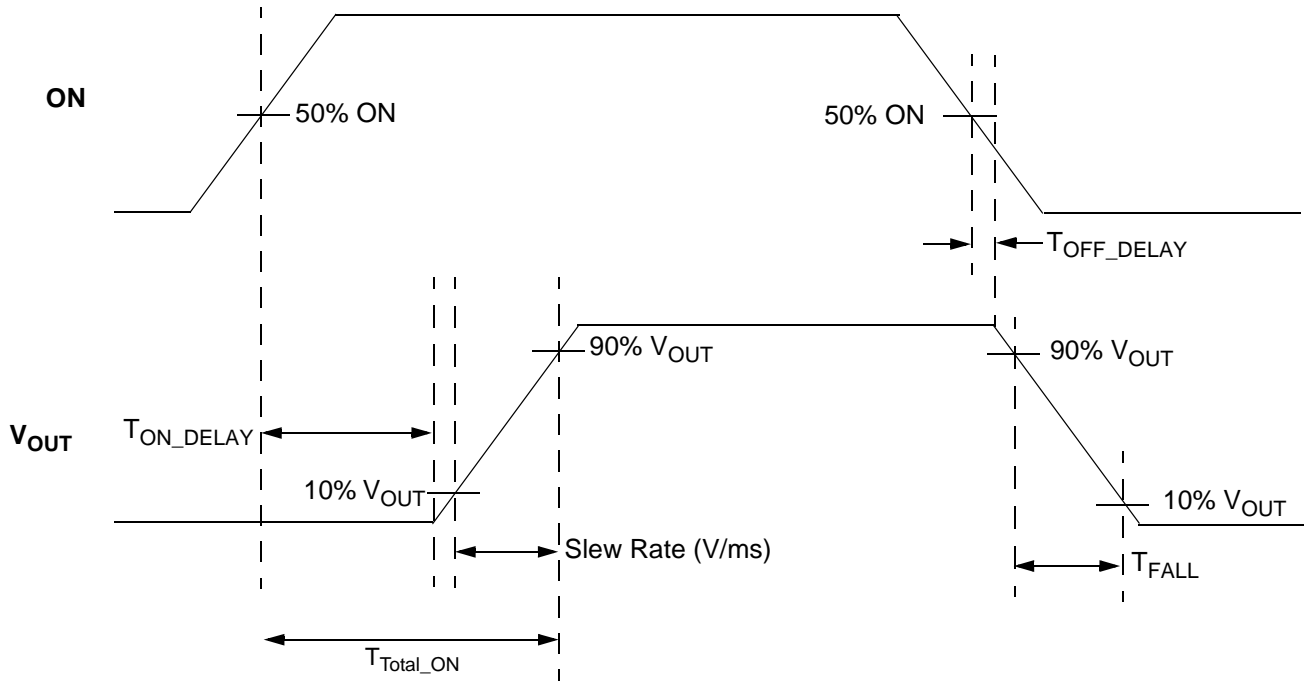



Package Top Marking System Definition







### Package Drawing and Dimensions

8 Lead TDFN Package 1.5 x 2.0 mm (Fused Lead)  
JEDEC MO-252, Variation W2015D

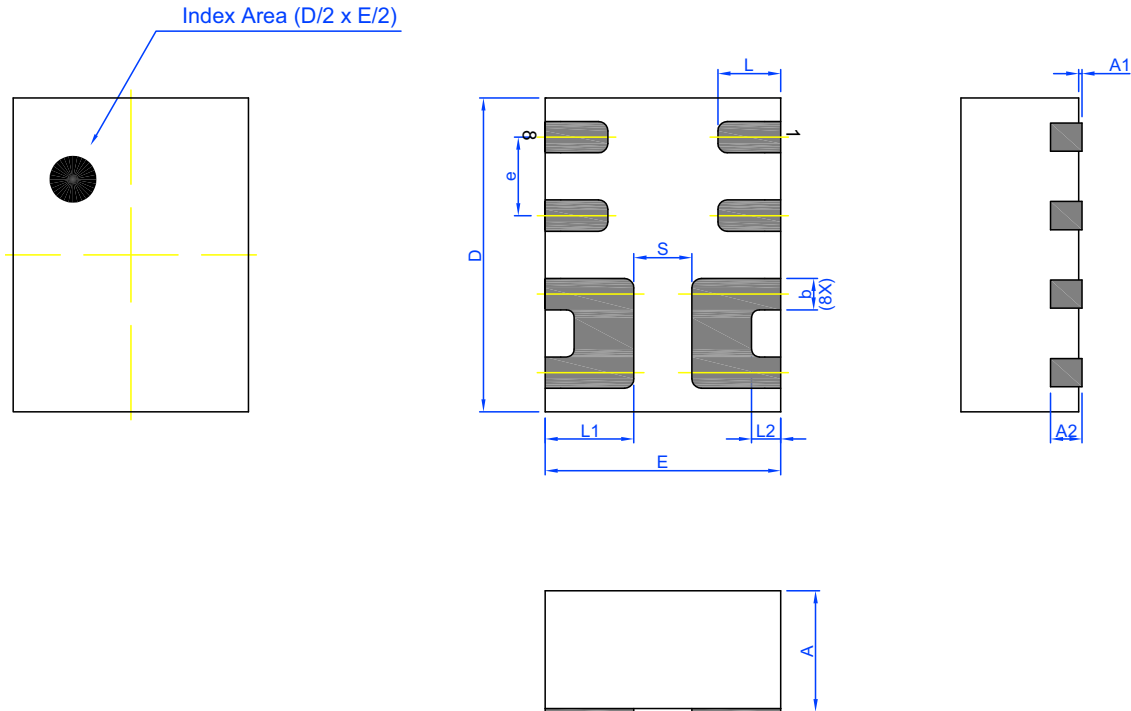

Unit: mm

Symbol	Min	Nom.	Max	Symbol	Min	Nom.	Max
A	0.70	0.75	0.80	L	0.35	0.40	0.45
A1	0.005	-	0.060	L1	0.515	0.565	0.615
A2	0.15	0.20	0.25	L2	0.135	0.185	0.235
b	0.15	0.20	0.25	e	0.50 BSC		
D	1.95	2.00	2.05	S	0.37 REF		
E	1.45	1.50	1.55				



**Tape and Reel Specifications**

Package Type	# of Pins	Nominal Package Size [mm]	Max Units		Reel & Hub Size [mm]	Leader (min)		Trailer (min)		Tape Width [mm]	Part Pitch [mm]
			per Reel	per Box		Pockets	Length [mm]	Pockets	Length [mm]		
TDFN 8L FC Green	8	1.5 x 2.0 x 0.75	3000	3000	178 / 60	100	400	100	400	8	4

**Carrier Tape Drawing and Dimensions**

Package Type	Pocket BTM Length	Pocket BTM Width	Pocket Depth	Index Hole Pitch	Pocket Pitch	Index Hole Diameter	Index Hole to Tape Edge	Index Hole to Pocket Center	Tape Width
	A0	B0	K0	P0	P1	D0	E	F	W
TDFN 8L FC Green	1.68	2.18	0.9	4	4	1.5	1.75	3.5	8



Refer to EIA-481 specification

**Recommended Reflow Soldering Profile**

Please see IPC/JEDEC J-STD-020: latest revision for reflow profile based on package volume of 2.25 mm<sup>3</sup> (nominal). More information can be found at [www.jedec.org](http://www.jedec.org).



---

**Revision History**

Date	Version	Change
4/28/2016	1.03	Added Reverse Current Blocking Description and clarified Current Limit Modes description
3/9/2016	1.02	Updated Ireverse

# Mouser Electronics

Authorized Distributor

Click to View Pricing, Inventory, Delivery & Lifecycle Information:

Silego:

[SLG59M610V](#) [SLG59M610VTR](#)