

# SSQE48S07120 DC-DC Converter

36-75VDC Input; 12VDC, 7A, 84W Output



## Features

- RoHS lead-free solder and lead-solder-exempted products are available
- Industry-standard DOSA pinout
- Output: 12 V at 7A
- On-board input differential LC-filter
- Start-up into pre-biased load
- No minimum load required
- Weight: 0.44 oz. [12.3 g]
- Fixed-frequency operation
- Hiccup overcurrent protection
- Fully protected (OTP, OCP, OVP, UVLO)
- Remote sense
- Remote ON/OFF positive or negative logic option
- Industry standard 1/16th brick footprint: 0.9" by 1.3"
- High reliability: MTBF = 10 million hours, calculated per Telcordia TR-332, Method I Case 1
- UL/CSA60950-1 recognized in US and Canada and TUV certified per IEC/EN60950-1
- Designed to meet Class B conducted emissions per FCC and EN55022 when used with external filter
- All materials meet UL94, V-0 flammability rating

The new **SSQE48S07120** DC-DC converter is an open frame sixteenth-brick DC-DC converter that conforms to the Distributed Open Standards Architecture (DOSA) specifications. The converter operates over an input voltage range of 36 to 75VDC, and provides a tightly regulated output voltage with an output current up to 7A. The output is fully isolated from the input and the converter meets Basic Insulation requirements permitting a positive or negative output configuration.

The converter is constructed using a single-board approach with both planar and discrete magnetics. The standard feature set includes remote On/Off (positive or negative logic), input undervoltage lockout, output overvoltage, overcurrent, and short circuit protections, and overtemperature shutdown with hysteresis.

With standard pinout and excellent thermal performance, the SSQE48S07120 converters can replace in most cases existing eighth-brick converters. Inclusion of this converter in a new design can result in significant board space and cost savings.

## Applications

- Telecommunications
- Data communications
- Wireless communications
- Servers, Workstations

## Benefits

- High efficiency – no heat sink required
- Cost effective, single board design
- Small size and low-profile.

### North America

+1-866.513.2839

### Asia-Pacific

+86.755.29885888

### Europe, Middle East

+353 61 225 977

tech.support@psbel.com  
[belpowersolutions.com](http://belpowersolutions.com)

# SSQE48S07120

## 1 Electrical Specifications

Conditions:  $T_A = 25\text{ }^\circ\text{C}$ , Airflow = 300 LFM (1.5 m/s),  $V_{in} = 48\text{ VDC}$ ,  $C_{in} = 33\text{ }\mu\text{F}$ , unless otherwise specified.

PARAMETER	NOTES	MIN	TYP	MAX	UNITS
<b>Absolute Maximum Ratings</b>					
Input Voltage	Continuous	0		80	VDC
Operating Ambient Temperature		-40		85	$^\circ\text{C}$
Storage Temperature		-55		125	$^\circ\text{C}$
<b>Isolation Characteristics</b>					
I/O Isolation (Standard Version – N)		2250			VDC
Isolation Capacitance (Standard Version - N)			150		pF
I/O Isolation (Option – K)		1500			VDC
Isolation Capacitance (Option - K)			1150		pF
Isolation Resistance		10			M $\Omega$
<b>Feature Characteristics</b>					
Switching Frequency			430		kHz
Output Voltage Trim Range <sup>1</sup>	Industry-standard equations (12V)	-20		+10	%
Remote Sense Compensation <sup>1</sup>	Percent of $V_{OUT(NOM)}$			+10	%
Output Over-voltage Protection	Non-latching	117	123	130	%
Over-temperature Shutdown (PCB)	Non-latching		125		$^\circ\text{C}$
Peak Backdrive Output Current during startup into prebiased output	Sinking current from external voltage source equal $V_{OUT(NOM)} - 0.6\text{V}$ and connected to the output via $1\Omega$ resistor. $C_{OUT}=220\mu\text{F}$ , Aluminum		10	50	mADC
Backdrive Output Current in OFF state	Converter is OFF; External voltage=5 VDC		10		mADC
Auto-Restart Period	Applies to all protection features		200		ms
Turn-On Time	See Figures B, C, and D		3		ms
ON/OFF Control (Positive Logic)					
Converter Off (logic low)		-20		0.8	VDC
Converter On (logic high)		2.4		20	VDC
ON/OFF Control (Negative Logic)					
Converter Off (logic high)		2.4		20	VDC
Converter On (logic low)		-20		0.8	VDC
<b>Mechanical</b>					
Weight			12.3		g
<b>Reliability</b>					
MTBF	Telcordia SR-332, Method I Case 1 50% electrical stress, $40^\circ\text{C}$ ambient		10		MHrs
<b>PARAMETER</b>					
<b>NOTES</b>					
<b>MIN</b>					
<b>TYP</b>					
<b>MAX</b>					
<b>UNITS</b>					
<b>Input Characteristics</b>					
Operating Input Voltage Range		36	48	75	VDC
Input Under-voltage Lockout					
Turn-on Threshold		33	34	35	VDC
Turn-off Threshold		31	32	33	VDC
Input Voltage Transient	100ms			100	VDC

866.513.2839

tech.support@psbel.com

[belpowersolutions.com](http://belpowersolutions.com)

# SSQE48S07120

Maximum Input Current	VIN = 36VDC , IOUT = 7ADC	2.6	ADC
Input Stand-by Current	Vin = 48V, converter disabled	10	12 mA
Input No Load Current (0 load on the output)	Vin = 48V, converter enabled	45	60 mA
Input Reflected-Ripple Current, is	Vin = 48V, 25MHz bandwidth	20	mAPK-PK
Input Voltage Ripple Rejection	120Hz	50	dB
<b>Output Characteristics</b>			
External Load Capacitance	Plus full resistive load	3,300	μF
Output Current Range	12VDC	0	7 ADC
Current Limit Inception	Non-latching, for 12VDC	7.35	8.25 9.0 ADC
Peak Short-Circuit Current (< 200 us)	Non-latching, Short = 10mΩ	25	A
RMS Short-Circuit Current	Non-latching	2.5	3.0 Arms
Output Voltage Set-point (no load)	Sense pins connected to output pins	11.82	12.00 12.18 V
<b>Output Regulation</b>			
Over Line		±2	±5 mV
Over Load		±2	±5 mV
Overall Output Voltage Regulation	Over line, load and temperature <sup>2</sup>	11.64	12.36 V
Output Ripple and Noise – 25 MHz bandwidth	Full load + 10μF tantalum + 1μF ceramic	100	150 mV <sub>PK-PK</sub>
<b>Dynamic Response</b>			
Load Change 50%-75%-50% of Iout Max, di/dt = 0.1 A/μs	Co = 1μF ceramic + 10μF tantalum Figure 8	100	150 mV
Settling Time to 1% of Vout		50	μs
Load Change 50%-75%-50% of Iout Max , di/dt = 1 A/μs	Co = 100μF tantalum + 1μF ceramic Figure 9	100	150 mV
Settling Time to 1% of Vout		50	75 μs
<b>Efficiency</b>			
100% Load	VOUT = 12 VDC	92	%
50% Load	VOUT = 12 VDC	93	%

<sup>1</sup>Vout can be increased up to 10% via the sense leads or 10% via the trim function. However, the total output voltage trim from all sources shall not exceed 10% of V<sub>OUT(NOM)</sub> in order to ensure specified operation of overvoltage protection circuitry. Trim up by 10% at full load is guaranteed for Vin > 38V.

<sup>2</sup> Operating ambient temperature range is -40 °C to 85 °C

## 2 Operations

### 2.1 Input and Output Impedance

These power converters have been designed to be stable with no external capacitors when used in low inductance input and output circuits.

However, in some applications, the inductance associated with the distribution from the power source to the input of the converter can affect the stability of the converter. A 33μF electrolytic capacitor with an ESR < 1Ω across the input is recommended to ensure stability of the converter over the wide range of input source impedance.

In many applications, the user has to use decoupling capacitance at the load. The power converter will exhibit stable operation with external load capacitance up to 3,300μF.

### 2.2 ON/OFF (PIN 2)

The ON/OFF pin is used to turn the power converter on or off remotely via a system signal. There are two remote control options available, positive and negative logic, both referenced to Vin(-). A typical connection is shown in Fig. A.

866.513.2839

tech.support@psbel.com

[belpowersolutions.com](http://belpowersolutions.com)

# SSQE48S07120

Fig. A: Typ. Circuit configuration for ON/OFF function

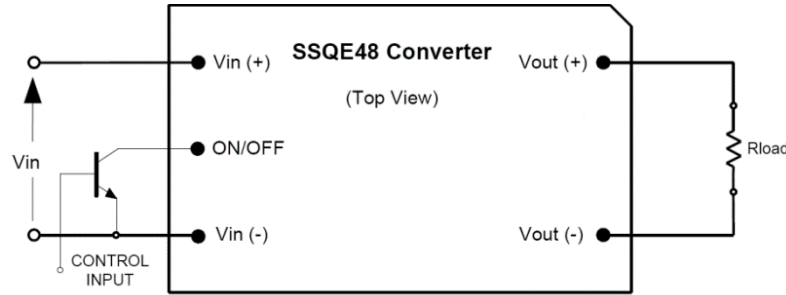

The positive logic version turns on when the ON/OFF pin is at a logic high and turns off when the pin is at a logic low. The converter is on when the ON/OFF pin is left open. See the Electrical Specifications for logic high/low definitions.

The negative logic version turns on when the pin is at a logic low and turns off when the pin is at a logic high. The ON/OFF pin can be hard wired directly to Vin(-) to enable automatic power up of the converter without the need of an external control signal.

The ON/OFF pin is internally pulled up to 5V through a resistor. A properly de-bounced mechanical switch, open-collector transistor, or FET can be used to drive the input of the ON/OFF pin. The device must be capable of sinking up to 0.2mA at a low level voltage of 0.8V. An external voltage source ( $\pm 20$  V maximum) may be connected directly to the ON/OFF input, in which case it must be capable of sourcing or sinking up to 1mA depending on the signal polarity. See the Startup Information section for system timing waveforms associated with use of the ON/OFF pin.

## 3 Protection Features

### 3.1 Input Undervoltage lockout

Input undervoltage lockout is standard with this converter. The converter will shut down when the input voltage drops below a pre-determined voltage.

The input voltage must be typically 35V for the converter to turn on. Once the converter has been turned on, it will shut off when the input voltage drops typically below 33V. This feature is beneficial in preventing deep discharging of batteries used in telecom applications.

### 3.2 Output Overcurrent Protection (OCP)

The converter is protected against overcurrent or short circuit conditions. Upon sensing an overcurrent condition, the converter will shut down in approximately 15ms after entering the constant current mode of operation, regardless of the value of the output voltage.

Once the converter has shut down, it will attempt to restart nominally every 200ms with a very low duty cycle. The attempted restart will continue indefinitely until the overload or short circuit conditions are removed.

Once the output current is brought back into its specified range, the converter automatically exits the hiccup mode and continues normal operation.

### 3.3 Output Overvoltage Protection (OVP)

The converter will shut down if the output voltage across Vout(+) (Pin 8) and Vout(-) (Pin 4) exceeds the threshold of the OVP circuitry. The OVP circuitry contains its own reference, independent of the output voltage regulation loop. Once the converter has shut down, it will attempt to restart every 200ms until the OVP condition is removed.

### 3.4 Overtemperature Protection (OTP)

The converter will shut down under an overtemperature condition to protect itself from overheating caused by operation outside the thermal derating curves, or operation in abnormal conditions such as system fan failure. Converter will automatically restart after it has cooled to a safe operating temperature.

866.513.2839

tech.support@psbel.com

[belpowersolutions.com](http://belpowersolutions.com)

# SSQE48S07120

## 3.5 Safety Requirements

The converters meet North American and International safety regulatory requirements per UL/CSA60950-1, EN60950-1, and IEC60950-1.

Basic Insulation is provided between input and output.

The converters have no internal fuse. If required, the external fuse needs to be provided to protect the converter from catastrophic failure. Refer to the “Input Fuse Selection for DC/DC converters” application note on [www.belpowersolutions.com](http://www.belpowersolutions.com) for proper selection of the input fuse. Both input traces and the chassis ground trace (if applicable) must be capable of conducting a current of 1.5 times the value of the fuse without opening. The fuse must not be placed in the grounded input line.

Abnormal and component failure tests were conducted with the input protected by a 15A fuse. If a fuse rated greater than a 15A is used, additional testing may be required. To protect a group of converters with a single fuse, the rating can be increased from the recommended value above.

## 3.6 Electromagnetic Compatibility (EMC)

EMC requirements must be met at the end-product system level, as no specific standards dedicated to EMC characteristics of board mounted component DC-DC converters exist. However, Bel Power Solutions tests its converters to several system level standards, primary of which is the more stringent EN55022, *Information technology equipment - Radio disturbance characteristics-Limits and methods of measurement*.

An effective internal LC differential filter significantly reduces input reflected ripple current, and improves EMC.

With the addition of a simple external filter, all versions of the SSQE48S07120 converters pass the requirements of Class B conducted emissions per EN55022 and FCC requirements. Please contact Bel Power Solutions Applications Engineering for details of this testing.

## 3.7 Startup Information (Using Negative ON/OFF)

Fig. B: Startup Scenario #1

### Scenario #1: Initial Startup From Bulk Supply

ON/OFF function enabled, converter started via application of  $V_{IN}$ . See Figure B.

Time	Comments
$t_0$	ON/OFF pin is ON; system front-end power is toggled on, $V_{IN}$ to converter begins to rise.
$t_1$	$V_{IN}$ crosses undervoltage Lockout protection circuit threshold; converter enabled.
$t_2$	Converter begins to respond to turn-on command (converter turn-on delay).
$t_3$	Converter $V_{OUT}$ reaches 100% of nominal value.

For this example, the total converter startup time ( $t_3 - t_1$ ) is typically 3 ms.

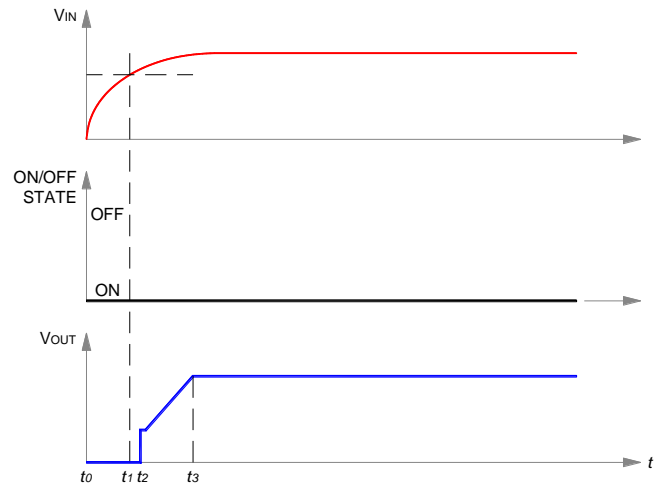

# SSQE48S07120

## Scenario #2: Initial Startup Using ON/OFF Pin

With  $V_{IN}$  previously powered, converter started via ON/OFF pin. See Figure C.

Time	Comments
$t_0$	$V_{INPUT}$ at nominal value.
$t_1$	Arbitrary time when ON/OFF pin is enabled (converter enabled).
$t_2$	End of converter turn-on delay.
$t_3$	Converter $V_{OUT}$ reaches 100% of nominal value.

For this example, the total converter startup time ( $t_3 - t_1$ ) is typically 3 ms.

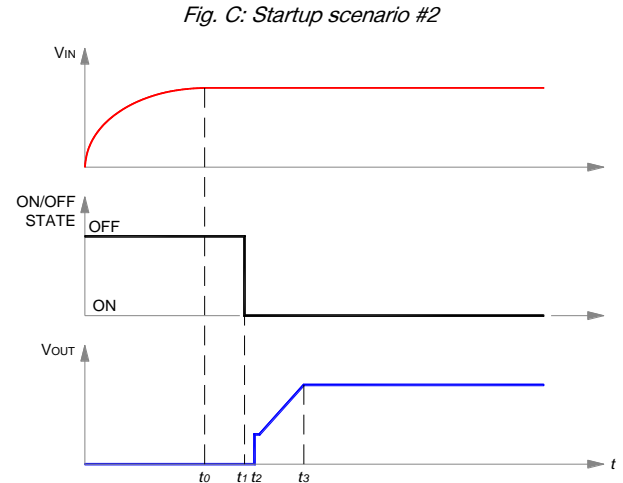

## Scenario #3: Turn-off and Restart Using ON/OFF Pin

With  $V_{IN}$  previously powered, converter is disabled and then enabled via ON/OFF pin. See Figure D.

Time	Comments
$t_0$	$V_{IN}$ and $V_{OUT}$ are at nominal values; ON/OFF pin ON.
$t_1$	ON/OFF pin arbitrarily disabled; converter output falls to zero; turn-on inhibit delay period (200 ms typical) is initiated, and ON/OFF pin action is internally inhibited.
$t_2$	ON/OFF pin is externally re-enabled. If $(t_2 - t_1) \leq 200$ ms, external action of ON/OFF pin is locked out by startup inhibit timer. If $(t_2 - t_1) > 200$ ms, ON/OFF pin action is internally enabled.
$t_3$	Turn-on inhibit delay period ends. If ON/OFF pin is ON, converter begins turn-on; if off, converter awaits ON/OFF pin ON signal; see Figure F.
$t_4$	End of converter turn-on delay.
$t_5$	Converter $V_{OUT}$ reaches 100% of nominal value.

For the condition,  $(t_2 - t_1) \leq 200$  ms, the total converter startup time ( $t_5 - t_2$ ) is typically 203 ms. For  $(t_2 - t_1) > 200$  ms, startup will be typically 3 ms after release of ON/OFF pin.

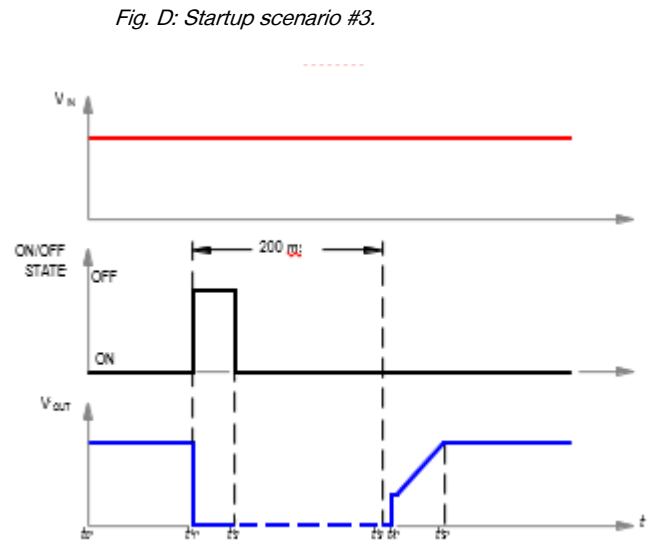

## 4 Characterization

### 4.1 General Information

The converters have been characterized for many operational aspects, to include thermal derating (maximum load current as a function of ambient temperature and airflow) for vertical and horizontal mounting, efficiency, startup and shutdown parameters, output ripple and noise, transient response to load step-change, overload, and short circuit.

### 4.2 Test Conditions

All data presented were taken with the converter soldered to a test board, specifically a 0.060" thick printed wiring board (PWB) with four layers. The top and bottom layers were not metallized. The two inner layers, comprised of two-ounce copper, were used to provide traces for connectivity to the converter.

866.513.2839

tech.support@psbel.com

[belpowersolutions.com](http://belpowersolutions.com)

# SSQE48S07120

The lack of metallization on the outer layers as well as the limited thermal connection ensured that heat transfer from the converter to the PWB was minimized. This provides a worst-case but consistent scenario for thermal derating purposes.

All measurements requiring airflow were made in the vertical and horizontal wind tunnel using Infrared (IR) thermography and thermocouples for thermometry.

Ensuring components on the converter do not exceed their ratings is important to maintaining high reliability. If one anticipates operating the converter at or close to the maximum loads specified in the derating curves, it is prudent to check actual operating temperatures in the application. Thermographic imaging is preferable; if this capability is not available, then thermocouples may be used. The use of AWG #40 gauge thermocouples is recommended to ensure measurement accuracy. Careful routing of the thermocouple leads will further minimize measurement error. Refer to Fig. E for the recommended measuring thermocouple location.

## 4.3 Thermal Derating

Load current vs. ambient temperature and airflow rates are given in Figure 1. Ambient temperature was varied between 25°C and 85°C, with airflow rates from 30 to 500 LFM (0.15 to 2.5 m/s).

For each set of conditions, the maximum load current was defined as the lowest of:

- (i) The output current at which any FET junction temperature does not exceed a maximum specified temperature of 125°C, or
- (ii) The temperature of the transformer does not exceed 125°C, or
- (iii) The nominal rating of the converter.

During normal operation, derating curves should not be exceeded. Also, temperature at the following thermocouple locations shown in Fig. E should be  $TC1 < 100^{\circ}C$ ,  $TC2 < 120^{\circ}C$ .

*Fig. E: Locations of the thermocouples for thermal testing*

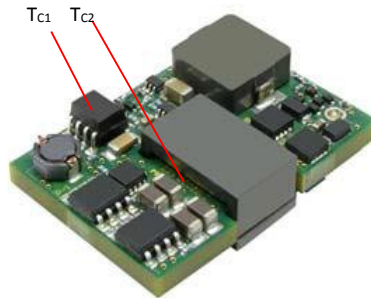

## 4.4 Efficiency

Figure 2 shows the efficiency vs. load current plot for ambient temperature of 25°C, airflow rate of 300 LFM (1.5m/s) with vertical mounting and input voltages of 36V, 48V, 65V, and 72V. Also, a plot of efficiency vs. load current, as a function of ambient temperature with  $V_{in} = 48V$ , airflow rate of 200 LFM (1m/s) with vertical mounting is shown in Figure 3..

## 4.5 Power Dissipation

Figure 4 shows the power dissipation vs. load current plot for  $T_a = 25^{\circ}C$ , airflow rate of 300 LFM (1.5m/s) with vertical mounting and input voltages of 36V, 48V, 65V, and 72V. Also, a plot of power dissipation vs. load current, as a function of ambient temperature with  $V_{in} = 48V$ , airflow rate of 200 LFM (1 m/s) with vertical mounting is shown in Figure 5.

## 4.6 Startup

Output voltage waveforms during the turn-on transient using the ON/OFF pin for full rated load currents (resistive load) are shown without and with external load capacitance in Figure 6 and Figure 7 respectively.

## 4.7 Ripple and Noise

Figure 10 shows the output voltage ripple waveform, measured at full rated load current with a 10 $\mu$ F tantalum and 1 $\mu$ F ceramic capacitor across the output. Note that all output voltage waveforms are measured across a 1 $\mu$ F ceramic capacitor.

The input reflected-ripple current waveforms are obtained using the test setup shown in Figure 11.

866.513.2839

tech.support@psbel.com

[belpowersolutions.com](http://belpowersolutions.com)

# SSQE48S07120

Figure 1. Available load current vs. ambient air temperature and airflow rates for SSQE48S07120 converter mounted vertically with air flowing from pin 1 to pin 3,  $V_{in} = 48V$ . Note: NC – Natural convection

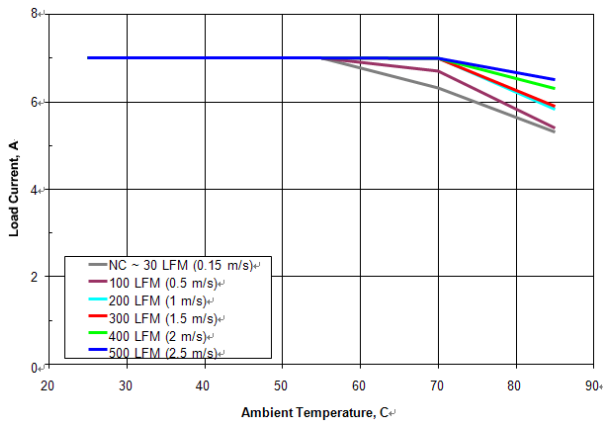

Figure 3. Efficiency vs. load current and ambient temperature for SSQE48S07120 converter mounted vertically with  $V_{in}=48V$  and air flowing from pin 1 to pin 3 at a rate of 200LFM (1.0m/s).

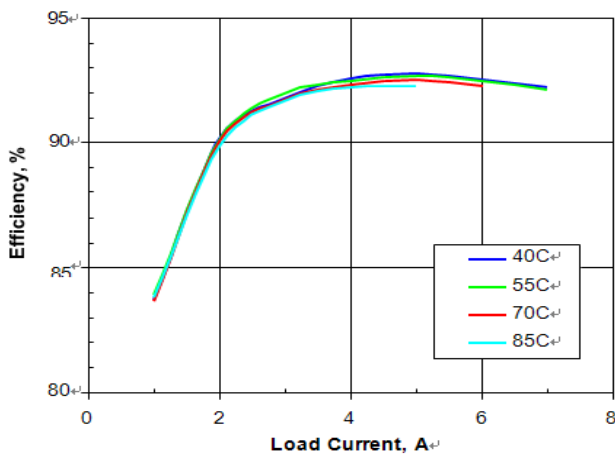

Figure 5. Power dissipation vs. load current and ambient temperature for SSQE48S07120 converter mounted vertically with  $V_{in} = 48 V$  and air flowing from pin 1 to pin 3 at a rate of 200 LFM (1.0 m/s).

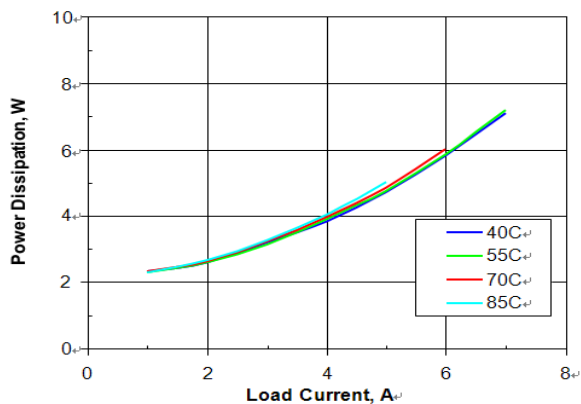

Figure 2. Efficiency vs. load current and input voltage for SSQE48S07120 converter mounted vertically with air flowing from pin 1 to pin 3 at a rate of 300 LFM (1.5m/s) and  $T_a=25^{\circ}C$ .

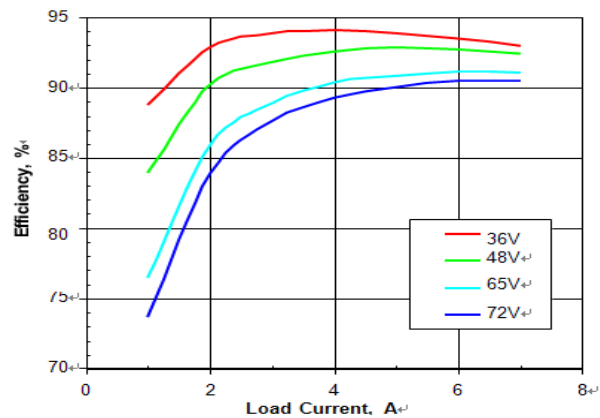

Figure 4. Power dissipation vs. load current and input voltage for SSQE48S07120 converter mounted vertically with air flowing from pin 1 to pin 3 at a rate of 300 LFM (1.5 m/s) and  $T_a = 25^{\circ}C$ .

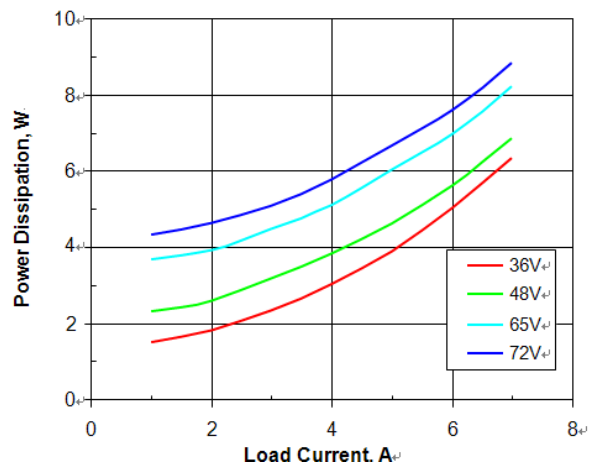
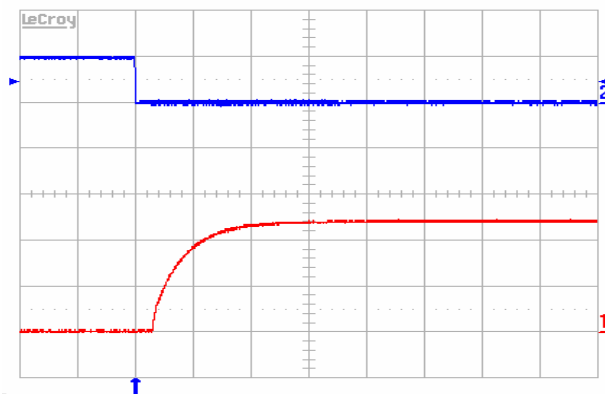

Figure 6. Turn-on transient at full rated load current (resistive) with no output capacitor at  $V_{in} = 48V$ , triggered via ON/OFF pin. Top trace: ON/OFF signal (5V/div.). Bottom trace: Output voltage (5V/div.). Time scale: 2ms/div.





# SSQE48S07120

Figure 7. Turn-on transient at full rated load current (resistive) plus 3,300 $\mu$ F at  $V_{in} = 48V$ , triggered via ON/OFF pin. Top trace: ON/OFF signal (5V/div.). Bottom trace: Output voltage (5V/div.). Time scale: 2ms/div.

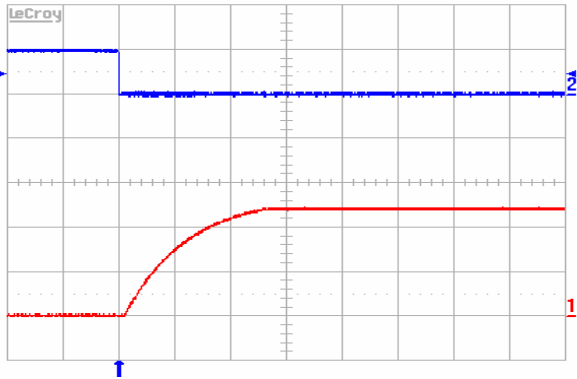

Figure 8. Output voltage response to load current step- (3.5A–5.25A–3.5A) at  $V_{in}=48V$ . Top trace: output voltage (100mV/div.) Bottom trace: load current (2A/div.). Current slew rate: 0.1A/ $\mu$ s.  $C_o=1\mu$ F ceramic + 10 $\mu$ F tantalum. Time scale: 0.2ms/div.

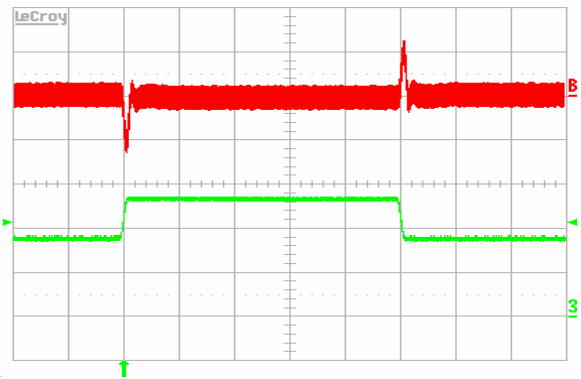

Figure 9. Output voltage response to load current step- (3.5A–5.25A–3.5A) at  $V_{in}=48V$ . Top trace: output voltage (100mV/div.). Bottom trace: load current (2A/div.). Current slew rate: 1A/ $\mu$ s.  $C_o= 100\mu$ F Tantalum + 1 $\mu$ F ceramic. Time scale: 0.2ms/div.

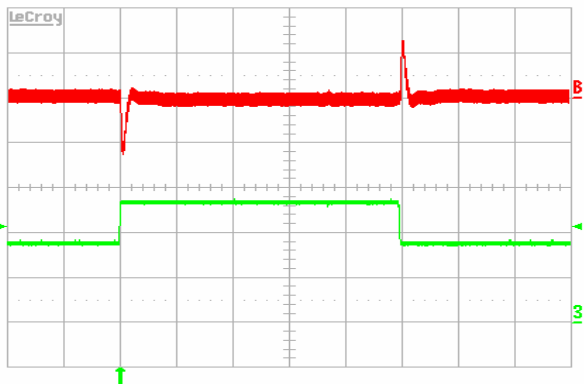

Figure 10. Output voltage ripple (10mV/div.) at full rated load current into a resistive load with  $C_o = 10\mu$ F tantalum + 1 $\mu$ F ceramic and  $V_{in} = 48 V$ . Time scale: 1  $\mu$ s/div.

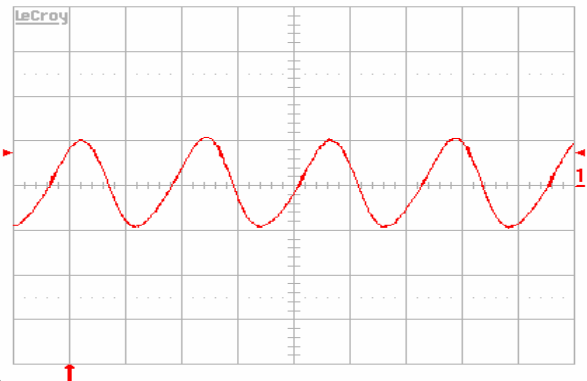
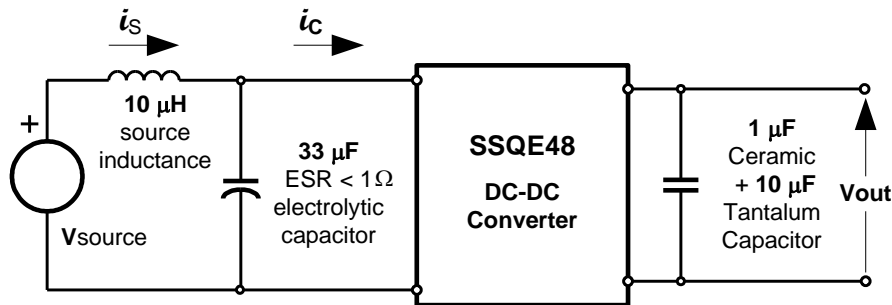

Figure 11. Test setup for measuring input reflected ripple currents,  $i_c$  and  $i_s$ .



# SSQE48S07120

Figure 12. Input reflected-ripple current,  $i_s$  (10mA/div.), measured through  $10\mu\text{H}$  at the source at full rated load current and  $V_{in} = 48\text{V}$ . Refer to Figure 11 for test setup. Time scale:  $1\mu\text{s}/\text{div}$ .

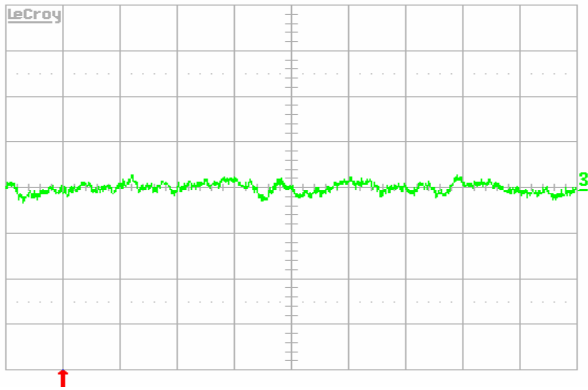

Figure 13. Input reflected ripple-current,  $i_C$  (50mA/div.), measured at input terminals at full rated load current and  $V_{in} = 48\text{V}$ . Refer to Figure 11 for test setup. Time scale:  $1\mu\text{s}/\text{div}$ .

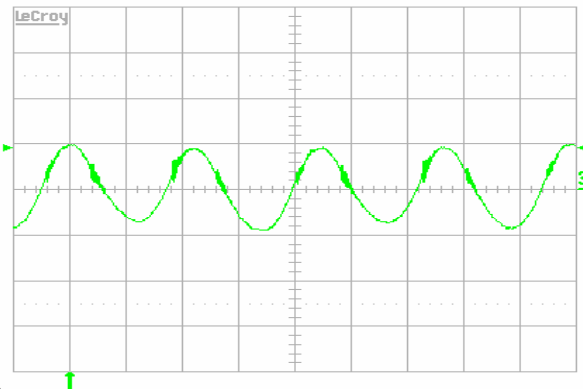
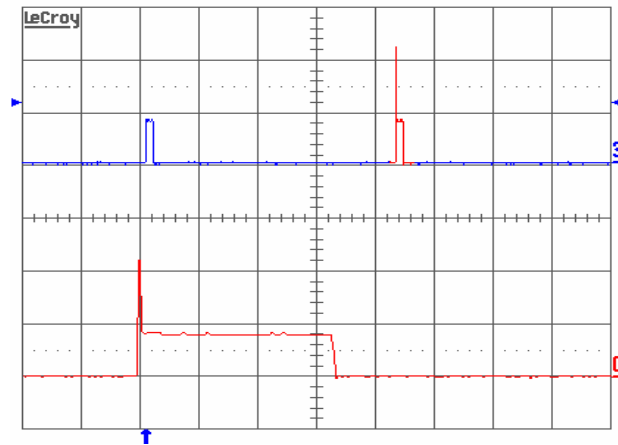

Figure 14. Load current (top trace, 5A/div., 50ms/div.) into a  $10\text{m}$  short circuit during restart, at  $V_{in} = 48\text{V}$ . Bottom trace (5A/div., 2ms/div.) is an expansion of the on-time portion of the top trace



# SSQE48S07120

## 5 Physical Information

### 5.1 SSQE48S PINOUT

Dimensions are in inches.  
Tolerances: x.xx in. ± 0.02 in.  
x.xxx in ± 0.010 in.

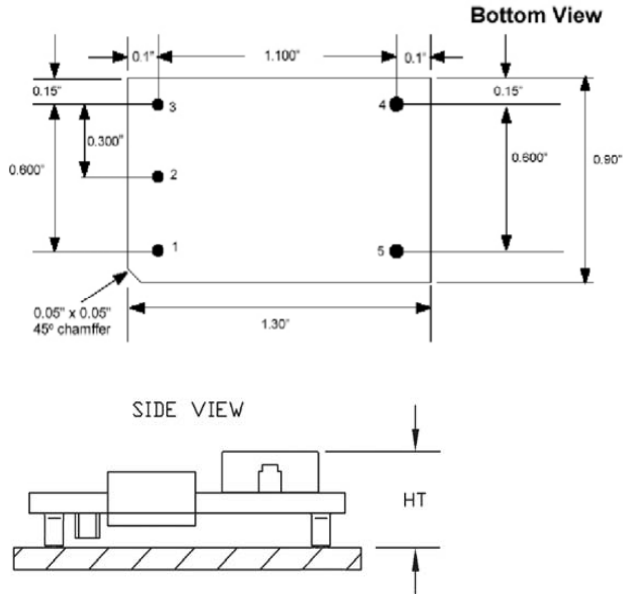

PAD/PIN CONNECTIONS	
PAD/PIN #	FUNCTION
1	Vin (+)
2	ON/OFF
3	Vin (-)
4	Vout (-)
5	Vout (+)

#### SSQE48S Platform Notes

- All dimensions are in inches [mm]
- Pin material: Brass Alloy
- Pin Finish: Gold over Nickel
- Converter Weight: 0.44 oz. [12.3 g] (est.)
- Pins 1 – 5: 0.062" dia. +/- 0.002"
- Suggested land pad: 0.110" dia.

\*Clearance from module to host board ≥ 0.020" HT<sub>MAX</sub>=0.400"

### 5.2 Converter Part Numbering / Ordering Information

PRODUCT SERIES	INPUT VOLTAGE	MOUNTING SCHEME	RATED LOAD CURRENT	OUTPUT VOLTAGE	ON/OFF LOGIC	MAXIMUM HEIGHT [HT]	PIN LENGTH [PL]	SPECIAL FEATURES	RoHS
SSQE	48	S	07	120	- N	S	0	N	G
Sixteenth Brick Format	36-75 V	S ⇒ Surface Mount	07 ⇒ 7 ADC	120 ⇒ 12 V	N ⇒ Negative P ⇒ Positive	S ⇒ SMT @ 0.400" MAX	0 ⇒ n/a	N ⇒ Standard K ⇒ 1150pF common mode cap, 1500VDC, and special OCP feature	No Suffix ⇒ RoHS lead-solder-exemption compliant G ⇒ RoHS compliant for all six substances

The example above describes P/N SSQE48S07120-NS0NG: 36-75V input, surface mount, 7A@ 12V output, negative enable (ON/OFF logic), maximum height of 0.400", standard feature set, and RoHS compliant for all 6 substances. Consult factory for availability of other options.

**For more information on these products consult: [tech.support@psbel.com](mailto:tech.support@psbel.com)**

**NUCLEAR AND MEDICAL APPLICATIONS** - Products are not designed or intended for use as critical components in life support systems, equipment used in hazardous environments, or nuclear control systems.

**TECHNICAL REVISIONS** - The appearance of products, including safety agency certifications pictured on labels, may change depending on the date manufactured. Specifications are subject to change without notice.

866.513.2839

[tech.support@psbel.com](mailto:tech.support@psbel.com)

[belpowersolutions.com](http://belpowersolutions.com)

# Mouser Electronics

Authorized Distributor

Click to View Pricing, Inventory, Delivery & Lifecycle Information:

[Bel Power Solutions:](#)

[SSQE48S07120-NS0NG](#)