



## SPECIFICATION FOR APPROVAL

Customer : \_\_\_\_\_  
Description : DC FAN \_\_\_\_\_  
Customer Part No. \_\_\_\_\_ REV. : \_\_\_\_\_  
Delta Model No. : THB1248CE \_\_\_\_\_ REV. : \_\_\_\_\_ 00  
Sample Issue No. : \_\_\_\_\_  
Sample Issue Date : APR.19 2016 \_\_\_\_\_

PLEASE SEND ONE COPY OF THIS SPECIFICATION BACK AFTER YOU SIGNED APPROVAL FOR PRODUCTION PRE-ARRANGMENT.

APPROVED BY:

DATE :

DELTA ELECTRONICS, INC.  
TAOYUAN PLANT  
252, SHANG YING ROAD, KUEI SAN INDUSTRIAL ZONE  
TAOYUAN SHIEN, TAIWAN, R.O.C.  
TEL:886-(0)3-3591968  
FAX:886-(0)3-3591991

\*\*\* SAMPLE HISTORY\*\*\*

CUSTOMER: STD.  
 CUSTOMER P/N: N.A  
 DELTA MODEL : THB1248CE

REV.	DESCRIPTION	DRAWN	CHECKED			APPROVED	ISSUE DATE
			ME	EE	CE		
00	ISSUE SPEC	劉文彬07/13'09	劉文彬07/13'09	楊坤昇07/13'09	-----	張楯成08/24'09	8/24'09
01	CHANGE THE MIN PRESSURE MIN TO 42.48 mmH2O ( 1.672 inchH2)	劉文彬05/28'10	劉文彬05/28'10	楊坤昇05/28'10	---	張楯成05/28'10	05/31'10
02	CHANGE THE SPEED RANGE TO 7800+/-10% & ADD THE SAFETY MARK & CHANGE THE LENGTH OF WIRE STRIP &CHANGE THE MATERIAL OF FRAME TO ALUMINUN AND WEIGHT	劉文彬03/10'11	劉文彬03/10'11	楊坤昇03/11'11	--	張楯成03/11'11	03/11'11
03	CURRECT THE LABEL MARK AND WIRE STRIP	劉文彬03/15'11	劉文彬03/15'11	楊坤昇03/15'11	---	張楯成08/09'11	08/09'11
04	CHANEGE WIRE STRIP TO 1007 #24 AND CHANGE TUBE P/N	劉文彬09/01'11	劉文彬09/01'11	黃清彰09/01'11	---	陳建樺 09/01'11	09/01'11
05	CHANGE WIRE LENGTH FROM 260mm TO 275mm	楊朝富 11/10'15	楊朝富 11/10'15	謝宗融 11/10'15	---	張楯成 11/10'15	11/10'15
06	ADD PWM INTERFACE CIRCUIT	謝宗融 04/19'16	楊朝富 04/19'16	謝宗融 04/19'16	---	張楯成 04/19'16	04/19'16

Delta Electronics, Inc.  
No.252, Shanying Rd., Guishan Dist.,  
Taoyuan City 333, Taiwan (R.O.C.)

TEL : 886-(0)3-3591968  
FAX : 886-(0)3-3591991

## STATEMENT OF DEVIATION

NONE

DESCRIPTION:

Delta Electronics, Inc.  
No.252, Shanying Rd., Guishan Dist.,  
Taoyuan City 333, Taiwan (R.O.C.)

TEL : 886-(0)3-3591968  
FAX : 886-(0)3-3591991

## Specification For Approval

Customer :

Description : DC FAN

Customer P/N :

rev. :

Delta model no. : THB1248CE

Delta Safety Model No.: THB1248CE

Sample revision. : 06

Issue no.:

Sample issue date :

Quantity :

### 1. SCOPE:

THIS SPECIFICATION DEFINES THE ELECTRICAL AND MECHANICAL CHARACTERISTICS OF THE DC BRUSHLESS AXIAL FLOW FAN.

### 2. CHARACTERS:

ITEM	DESCRIPTION
RATED VOLTAGE	48 VDC
OPERATION VOLTAGE	36.0 - 60.0 VDC
INPUT CURRENT (AVG.)	0.95 (MAX. 1.14) A SAFETY CURRENT ON LABEL : 1.14A
INPUT POWER(AVG)	45.6 (MAX. 54.72) W
SPEED	7800 ± 10% R.P.M.
MAX. AIR FLOW (AT ZERO STATIC PRESSURE)	7.360 (MIN. 6.624) M <sup>3</sup> /MIN. 262 (MIN. 235.80) CFM
MAX. AIR PRESSURE (AT ZERO AIRFLOW)	51.44 (MIN. 41.67) mmH2O 2.025 (MIN. 1.640) inchH2O
ACOUSTICAL NOISE (AVG.)	70.0 (MAX 73.0) dB-A
INSULATION TYPE	UL: CLASS A
CURRENT ON LABEL	1.14A

(continued)

PAGE 1

PART NO:

DELTA MODEL: THB1248CE

INSULATION STRENGT	10 MEG OHM MIN. AT 500 VDC (BETWEEN FRAME AND (+) TERMINAL)
DIELECTRIC STRENGTH	5 mA MAX. AT 500 VAC 50/60 Hz ONE MINUTE, (BETWEEN FRAME AND (+) TERMINAL)
EXTERNAL COVER	OPEN TYPE
LIFE EXPECTANCE (L10) (AT LABEL VOLTAGE)	70,000 HOURS CONTINUOUS OPERATION AT 40 °C WITH 15 ~ 65 %RH.
ROTATION	CLOCKWISE VIEW FROM NAME PLATE SIDE
LOCKED CURRENT SHUT DOWN	THE CURRENT WILL SHUT DOWN, WHEN ROTOR LOCKED AND FIXED.
LEAD WIRE	UL 1007 AWG #24 BLACK WIRE NEGATIVE(-) RED WIRE POSITIVE(+) BLUE WIRE FREQUENCY(F00 ) YELLOW WIRE SPEED CONTROL(PWM)

NOTES:

1. ALL READINGS ARE MEASURED AFTER STABLY WARMING UP THROUGH 10 MINUTES.
2. STANDARD AIR PROPERTY IS AIR AT (Td) 25°C TEMPERATURE, (RH) 65% RELATIVE HUMIDITY , AND (Pb) 760 mmHg BAROMETRIC PRESSURE.
3. THE VALUES WRITTEN IN PARENS , ( ), ARE LIMITED SPEC.
4. ACOUSTICAL NOISE MEASURING CONDITION:

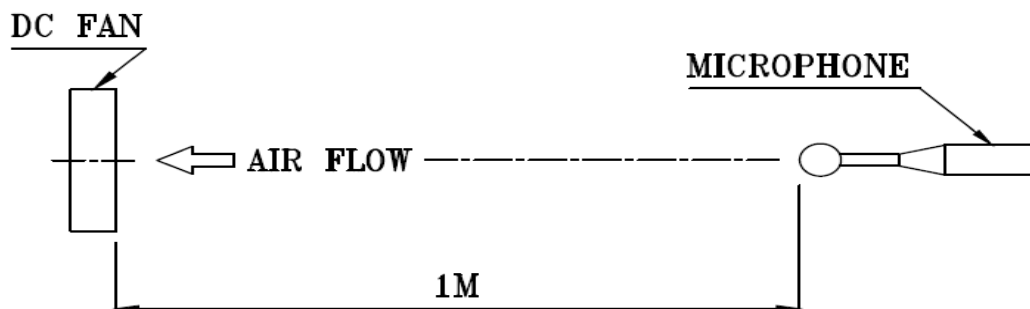

---

PART NO:

---

DELTA MODEL: THB1248CE

---

3. MECHANICAL:

- 3-1. DIMENSIONS----- SEE DIMENSIONS DRAWING
- 3-2. FRAME----- DIE-CAST ALUMINUM
- 3-3. IMPELLER----- PLASTIC UL: 94V-0
- 3-4. BEARING SYSTEM----- TWO BALL BEARINGS
- 3-5. WEIGHT----- 415 GRAMS

4. ENVIRONMENTAL:

- 4-1. OPERATING TEMPERATURE----- -10 TO +70 DEGREE C
- 4-2. STORAGE TEMPERATURE----- -40 TO +70 DEGREE C
- 4-3. OPERATING HUMIDITY----- 5 TO 90 % RH
- 4-4. STORAGE HUMIDITY----- 5 TO 90 % RH

5. PROTECTION:

- 5-1. LOCKED ROTOR PROTECTION  
IMPEDANCE OF MOTOR WINDING PROTECTS MOTOR FROM FIRE IN  
96 HOURS OF LOCKED ROTOR CONDITION AT THE RATED VOLTAGE.
- 5-2. POLARITY PROTECTION  
BE CAPABLE OF WITHSTANDING IF REVERSE CONNECTION FOR  
POSITIVE AND NEGATIVE LEADS.

6. RE OZONE DEPLETING SUBSTANCES:

- 6-1. NO CONTAINING PBBs, PBBOs, CFCs, PBBEs, PBDPEs AND HCFCs.

7. PRODUCTION LOCATION

- 7-1. PRODUCTS WILL BE PRODUCED IN CHINA OR THAILAND.

PART NO:

DELTA MODEL: THB1248CE

8. P & Q CURVE:

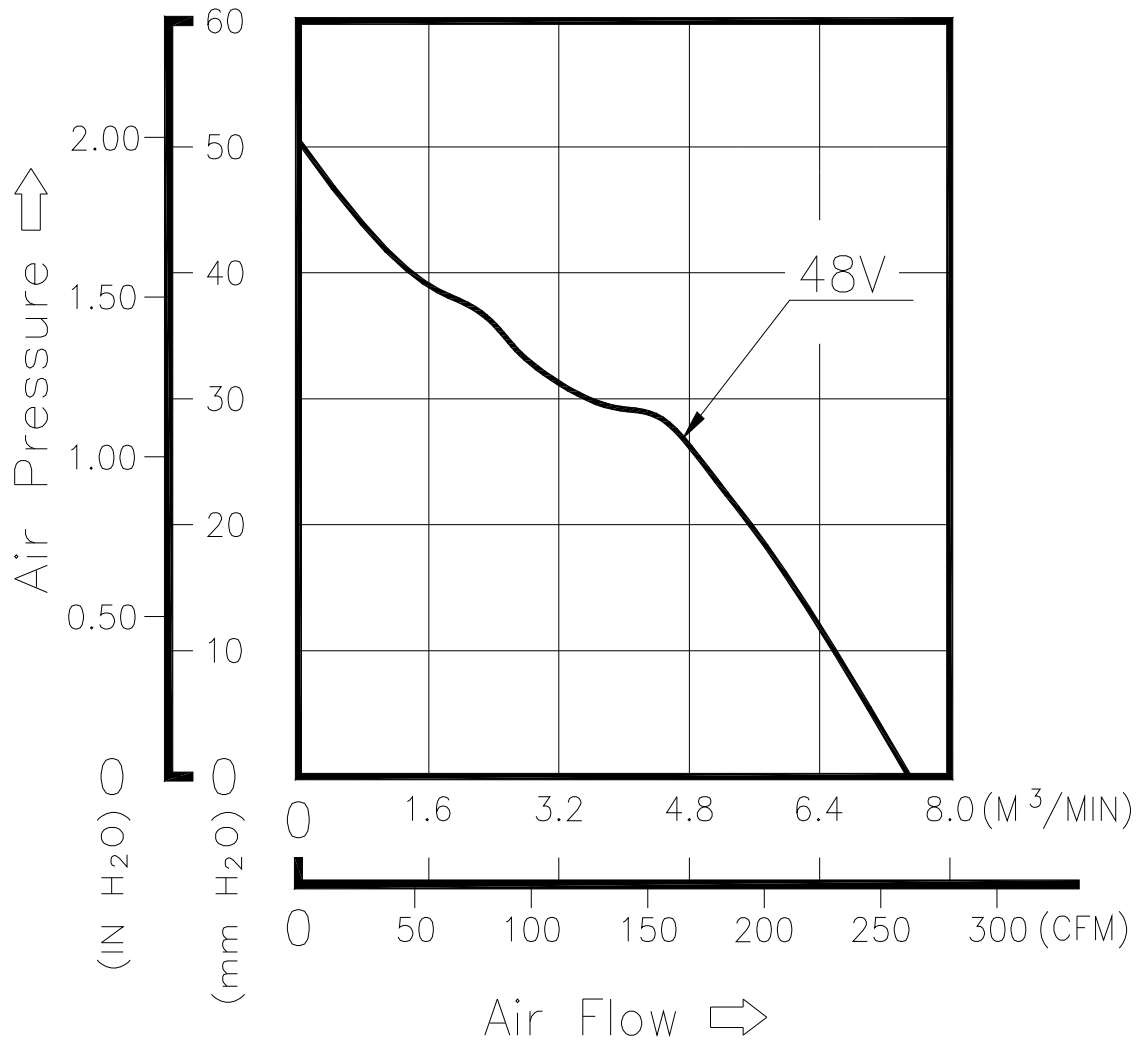

\*TEST CONDITION: INPUT VOLTAGE-----OPERATION VOLTAGE  
TEMPERATURE-----ROOM TEMPERATURE  
HUMIDITY-----65%RH

PART NO:

DELTA MODEL: THB1248CE

9. DIMENSION DRAWING:

LABEL:

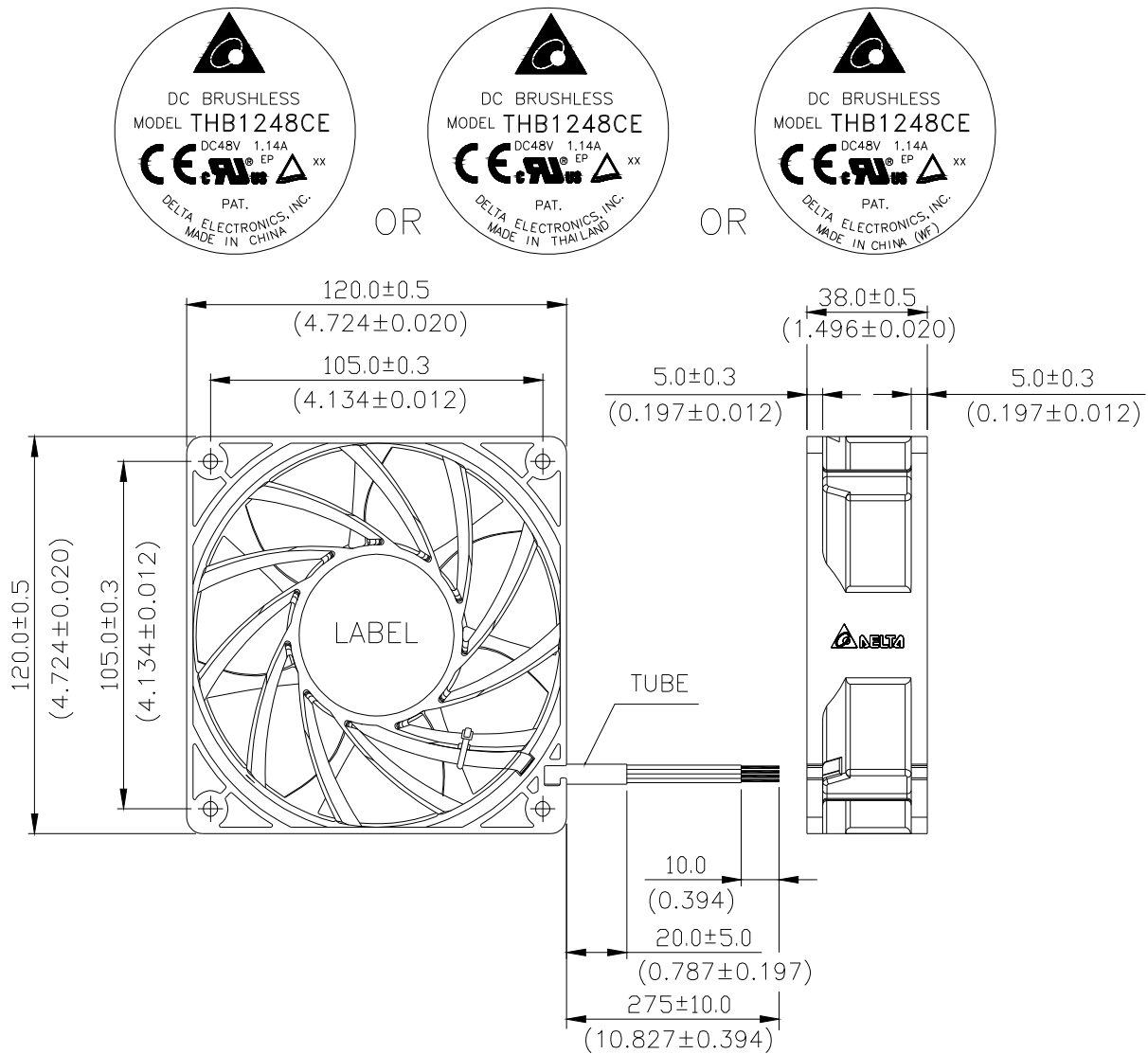

NOTES:

1. LEAD WIRE UL1007 AWG#24  
BLACK WIRE ---- (-)  
RED WIRE ---- (+)  
YELLOW WIRE ---- (PWM)  
BLUE WIRE ---- (F00)
2. TUBE: T4\*0.55 105°C 600V BLACK UL, CSA APPROVED.  
(DELTA P/N: 3227100800)
3. THIS PRODUCT IS ROHS COMPLIANT



PART NO:

DELTA MODEL: THB1248CE

10. FREQUENCY GENERATOR (FG) SIGNAL:

1. OUTPUT CIRCUIT - OPEN COLLECTOR MODE:

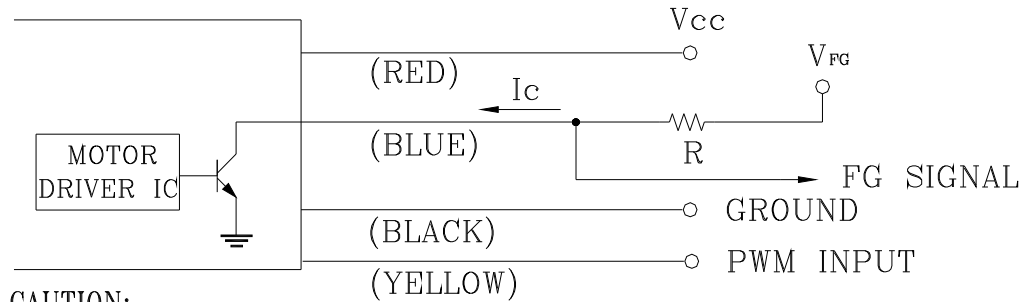

CAUTION:

THE LEAD WIRE OF FG SIGNAL CAN NOT TOUCH  
THE LEAD WIRE OF POSITIVE OR NEGATIVE.

2. SPECIFICATION:

$$V_{CE(sat)} = 0.5V \text{ MAX.}$$

$$I_c = 10mA \text{ MAX.}$$

$$V_{FG} = 60.0V \text{ MAX}$$

$$R \geq V_{FG} / I_c$$

3. FREQUENCY GENERATOR WAVEFORM:

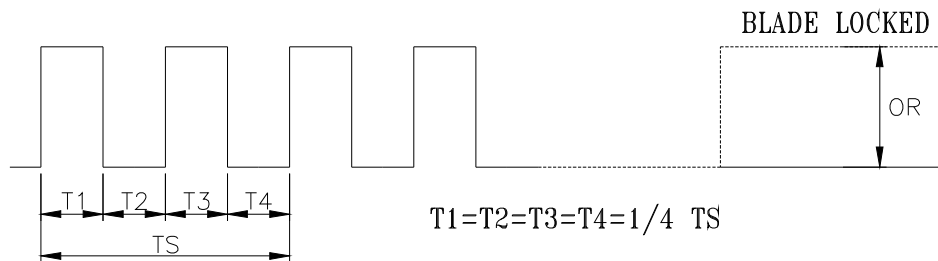
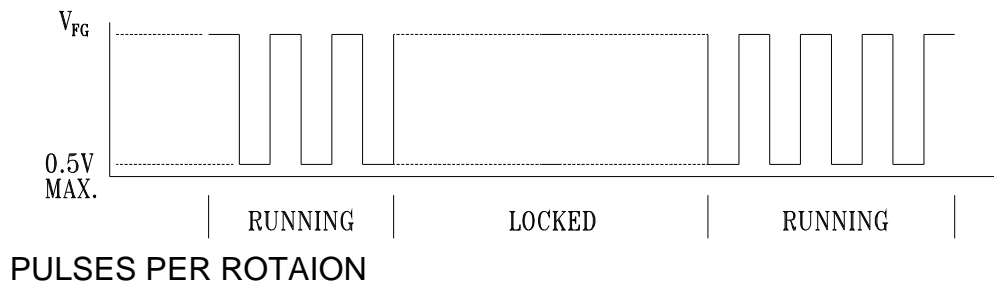

N=R.P.M

$$TS=60/N(\text{SEC})$$

\*VOLTAGE LEVEL AFTER BLADE LOCKED

\*4 POLES

PART NO:

DELTA MODEL: THB1248CE

11. PWM CONTROL SIGNAL: (AT 48VDC ; 25 DEGREE C)  
SIGNAL VOLTAGE RANGE: 0~10VDC

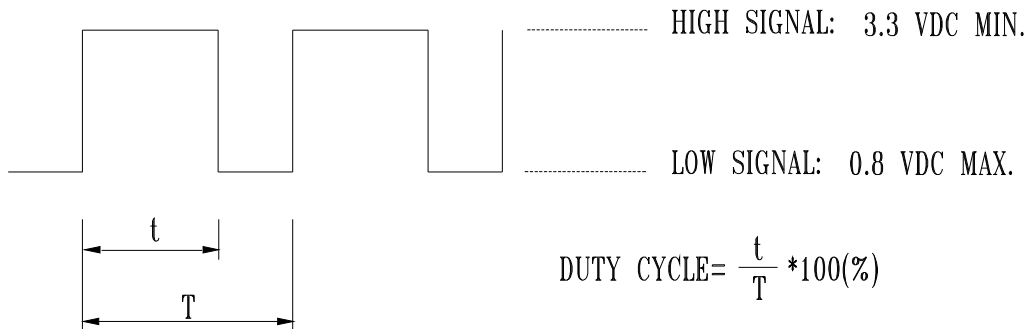

- PWM SIGNAL WITH 5 VDC TTL OR CMOS LEVELS. THE PREFERRED OPERATING POINT FOR THE FAN IS 20k HZ, AND DUTY CYCLE FORM 0% TO 100%.
- AT 100% DUTY CYCLE, THE ROTOR WILL SPIN AT MAXIMUM SPEED.
- AT 0% DUTY CYCLE, THE ROTOR WILL STOP.
- WITH CONTROL SIGNAL LEAD DISCONNECTED, THE FAN WILL SPIN AT MAXIMUM SPEED.

12. SPEED VS PWM CONTROL SIGNAL: (AT RATED VOLTAGE ; 25 DEGREE C ; PWM SIGNAL WITH 5 VDC TTL OR CMOS LEVELS & 20 KHZ)

DUTY CYCLE (%)	SPEED R.P.M (REF.)	CURRENT (A) T.Y.P
100	7800±10%	0.95
50	4500±10%	0.30
0	0	0.01

13. PWM INPUT CIRCUIT

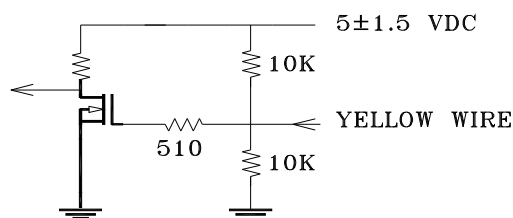



## ***Application Notice***

- 1. Delta will not guarantee the performance of the products if the application condition falls outside the parameters set forth in the specification.**
- 2. A written request should be submitted to Delta prior to approval if deviation from this specification is required.**
- 3. Please exercise caution when handling fans. Damage may be caused when pressure is applied to the impeller, if the fans are handled by the lead wires, or if the fan was hard-dropped to the production floor.**
- 4. Except as pertains to some special designs, there is no guarantee that the products will be free from any such safety problems or failures as caused by the introduction of powder, droplets of water or encroachment of insect into the hub.**
- 5. The above-mentioned conditions are representative of some unique examples and viewed as the first point of reference prior to all other information.**
- 6. It is very important to establish the correct polarity before connecting the fan to the power source. Positive (+) and Negative (-). Damage may be caused to the fans if connection is with reverse polarity, if there is no foolproof method to protect against such error specifically mentioned in this spec.**
- 7. Delta fans without special protection are not suitable where any corrosive fluids are introduced to their environment.**
- 8. Please ensure all fans are stored according to the storage temperature limits specified. Do not store fans in a high humidity environment. We highly recommend performance testing is conducted before shipping, if the fans have been stored over 6 months.**
- 9. Not all fans are provided with the Lock Rotor Protection feature. If you impair the rotation of the impeller for the fans that do not have this function, the performance of those fans will lead to failure.**
- 10. Please be cautious when mounting the fan. Incorrect mounting of fans may cause excess resonance, vibration and subsequent noise.**
- 11. It is important to consider safety when testing the fans. A suitable fan guard should be fitted to the fan to guard against any potential for personal injury.**
- 12. Except where specifically stated, all tests are carried out at room (ambient) temperature and relative humidity conditions of 25°C, 65% RH. The test value is only for fan performance itself.**
- 13. Be certain to connect an “ 4.7μF or greater” capacitor to the fan externally when the application calls for using multiple fans in parallel, to avoid any unstable power.**

# Mouser Electronics

Authorized Distributor

Click to View Pricing, Inventory, Delivery & Lifecycle Information:

[Delta Electronics:](#)

[THB1248CE](#)