

Illumination element

45-320.2N11

Distribution by
Mouser



<https://mouser.eao.com/p/45-320.2N11>

Your product:



45-320.2N11 Illumination element

MOUNTING

Component mounting type: Base mounting

OPERATING-/INDICATION PART

Illumination colour: White

ELECTRICAL CHARACTERISTICS

Operating voltage: 6 - 24 V AC/DC

Surge voltage resistance: 4 kV

Lumi. Intensity: 900 - 1400 mcd

MECHANICAL CHARACTERISTIC

Terminal: Screw terminal

Weight: 0.02 kg

CERTIFICATE

REACH: REACH compliant

RoHS: RoHS compliant

OTHER

Short Description: Illumination element, Screw terminal, White, 6 - 24 V AC/DC, Base mounting

Hints: Illumination element base mounting can used only with enclosure

Wiring diagrams:

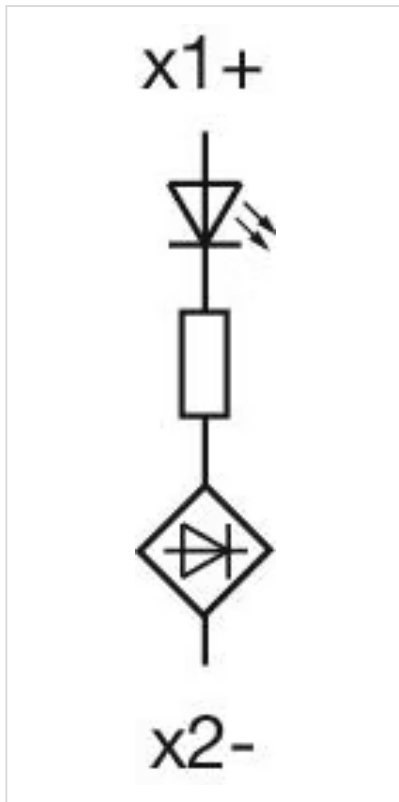

Dimension drawings:

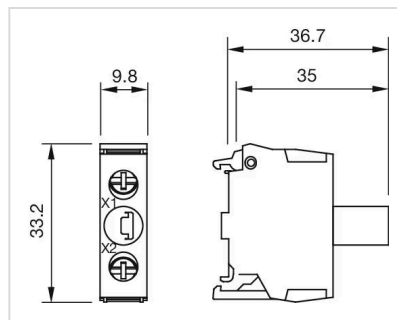

Mouser Electronics

Authorized Distributor

Click to View Pricing, Inventory, Delivery & Lifecycle Information:

[EAO:](#)

[45-320.2N11](#)