

IO-Link Touch Standard

84-ASKS-C14-04A5



<https://eao.com/p/84-ASKS-C14-04A5>

Your product:



84-ASKS-C14-04A5 IO-Link Touch Standard

FRONT

Front dimension:	Ø 30 mm
Front form:	round
Front bezel material:	Plastic

MOUNTING

Design:	flush
Mounting cut-out:	Ø 22.5 mm
Mounting type:	Panel mounting

OPERATING-/INDICATION PART

Lens material:	Plastic
Lens illumination:	illuminative
Lens shape:	flush
Lens optics:	transparent
Symbol:	Standby (C14)

ELECTRICAL CHARACTERISTICS

Operating voltage:	8,4 - 32 V DC
---------------------------	---------------

MECHANICAL CHARACTERISTIC

Terminal:	Connector M12
Switching system:	Capacitive

Operating force: No actuating force necessary

Weight: 0.015 kg

AMBIENT CONDITION

IP front protection: IP69K

IK front protection: IK08

Operating temperature: - 30 °C ... + 65 °C

Climate resistance: Relative humidity, max. 95%, non-condensing

CERTIFICATE

Approbations: CSA, EHEDG

Conformities: CE, UKCA

REACH: REACH compliant

RoHS: RoHS compliant

OTHER

Short Description: IO-Link Touch Standard, Ø 22.5 mm, Ø 30 mm, flush, illuminative, Plastic, transparent, round, Plastic, Connector M12, IP69K, IK08, Standby (C14)

Housing colour: Black

Housing material: Plastic

Wiring diagrams:

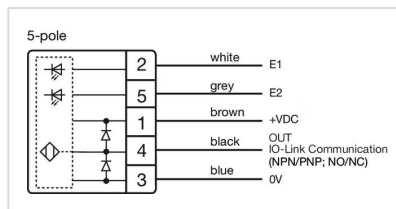
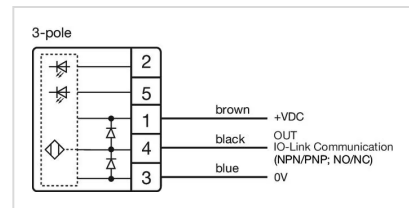
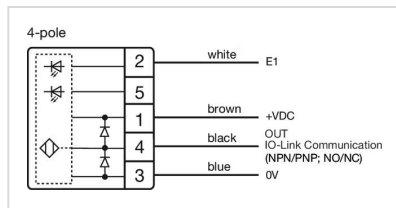

Component layouts:

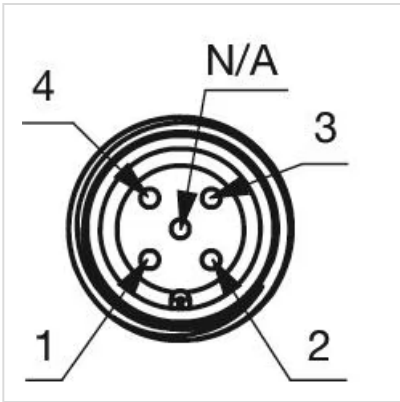
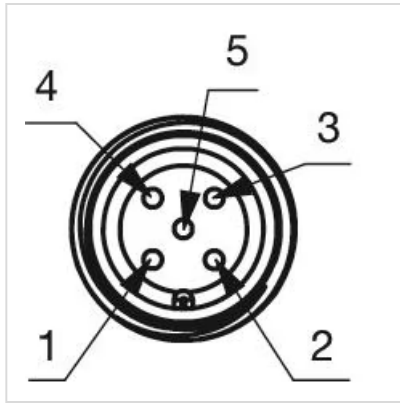
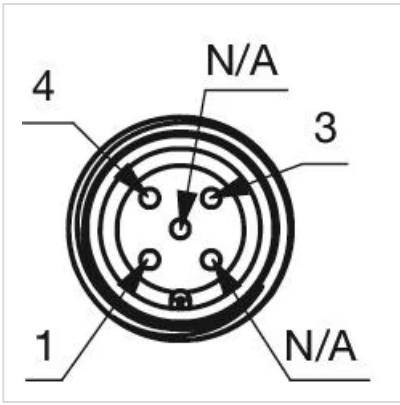



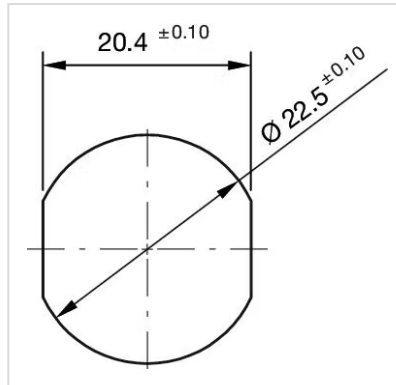



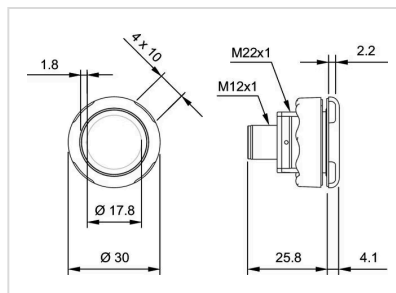



Mounting cut-outs:



Dimension drawings:



Where to Buy

	Distributor	Quantity in Stock	
	DigiKey	10 in stock	Buy 
	Newark	7 in stock	Buy 
	Farnell UK	7 in stock	Buy 
	element14 Singapore	7 in stock	Buy 
	Mouser Electronics	0 in stock	Buy 

[Show more](#) 

Powered by oemsecrets.com

Mouser Electronics

Authorized Distributor

Click to View Pricing, Inventory, Delivery & Lifecycle Information:

[EAO:](#)

[84-ASKS-C14-04A5](#)