

# Actuator

45-  
2530.1920.000



<https://eao.com/p/45-2530.1920.000>

Your product:

---



## 45-2530.1920.000 Actuator

### FRONT

<b>Front dimension:</b>	Ø 40 mm
<b>Front form:</b>	round
<b>Front bezel colour:</b>	Black
<b>Front bezel material:</b>	Plastic

### MOUNTING

<b>Design:</b>	raised
<b>Mounting cut-out:</b>	Ø 22.3 mm
<b>Mounting type:</b>	Panel mounting

### OPERATING-/INDICATION PART

<b>Lens colour:</b>	Red
<b>Lens material:</b>	Plastic
<b>Lens illumination:</b>	non illuminative
<b>Lens shape:</b>	mushroom-head
<b>Lens optics:</b>	opaque

### MECHANICAL CHARACTERISTIC

<b>Switching action:</b>	Maintained
<b>Switching system:</b>	Slow-make switching element
<b>Release type:</b>	Pull unlock
<b>Mechanical lifetime:</b>	500 000 cycles of operation

**Operating frequency:** Max. 1 800/h

**Weight:** 0.028 kg

### **AMBIENT CONDITION**

**IP front protection:** IP66, IP67, IP69K

**Operating temperature:** – 25 °C ... + 70 °C

**Storage temperature:** – 40 °C ... + 80 °C

**Shock resistance:** According to IEC 60068-2-27: Sinusoidal half-wave 50 g / 11 ms

**Vibration resistance:** According to IEC 60068-2-6: 20 ... 500 Hz: 5 g

**Climate resistance:** During operation according to IEC 60721: 3K6, 3C3, 3S2, 3M6

### **CERTIFICATE**

**REACH:** REACH compliant

**RoHS:** RoHS compliant

### **OTHER**

**Short Description:** Actuator, Ø 22.3 mm, Ø 40 mm, mushroom-head, non illuminative, Red, Plastic, opaque, round, Black, Plastic, Maintained, IP66, IP67, IP69K, Pull unlock

**Housing colour:** Black

**Housing material:** Plastic

**Wiring diagrams:**

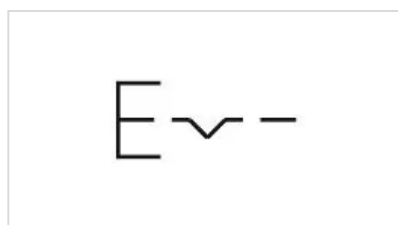



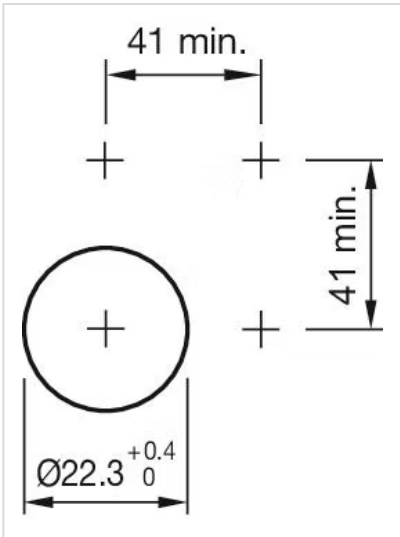



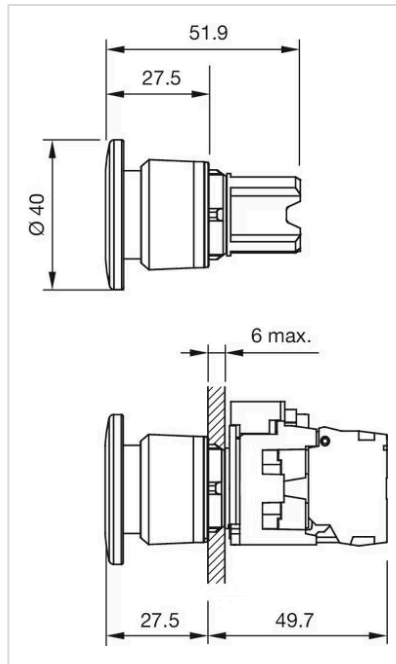



**Mounting cut-outs:**



Dimension drawings:



Where to Buy

	Distributor	Quantity in Stock	
	RS UK	30 in stock	<a href="#">Buy</a> 
	Distrelec	12 in stock	<a href="#">Buy</a> 
	Rapid Electronics	10 in stock	<a href="#">Buy</a> 
	Mouser Electronics	5 in stock	<a href="#">Buy</a> 
	Digi-Key	5 in stock	<a href="#">Buy</a> 

[Show more](#) 

Powered by oemsecrets.com

# Mouser Electronics

Authorized Distributor

Click to View Pricing, Inventory, Delivery & Lifecycle Information:

[EAO:](#)

[45-2530.1920.000](#)