

Housing pole mounting

84-9600.4



<https://eao.com/p/84-9600.4>

Your product:



84-9600.4 Housing pole mounting

FRONT

Colour: Yellow

MOUNTING

Mounting cut-out: Ø 22.5 mm

MECHANICAL CHARACTERISTIC

Weight: 0.03 kg

OTHER

Short Description: Housing pole mounting, Ø 22.5 mm, Plastic, Yellow

Titel Accessory: Housing pole mounting

Material: Plastic

Product attributes: Please note: The cut-out of the pole must read min. 22 mm and needs to be aligned with the switch







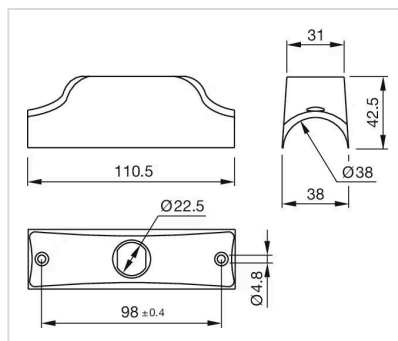



Hints: Screws are not contained in the scope of supply

Colour RAL: 1023 RAL

Dimension drawings:



Where to Buy

	Distributor	Quantity in Stock	
	DigiKey	5 in stock	Buy 
	Mouser Electronics	0 in stock	Buy 
	Sager	0 in stock	Buy 
	Newark	0 in stock	Buy 
	RS Americas	0 in stock	Buy 

Mouser Electronics

Authorized Distributor

Click to View Pricing, Inventory, Delivery & Lifecycle Information:

[EAO:](#)

[84-9600.4](#)