

Flachbandkabelführung: schwarz  
wire guide: black

11.4  
mit aufgesetzter Drahtführung  
(Anlieferungszustand)  
with wire guide mounted  
(state at time of supply)

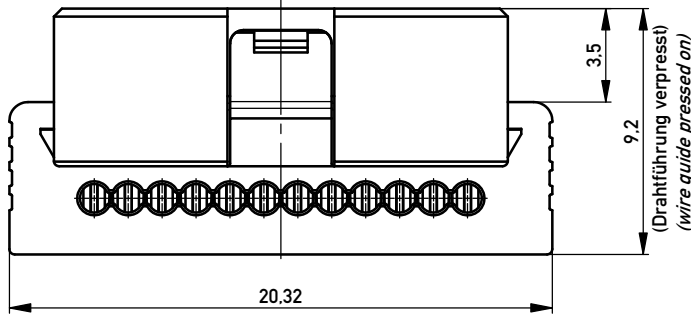

3.5  
9.2  
(Drahtführung verpresst)  
(wire guide pressed on)



3

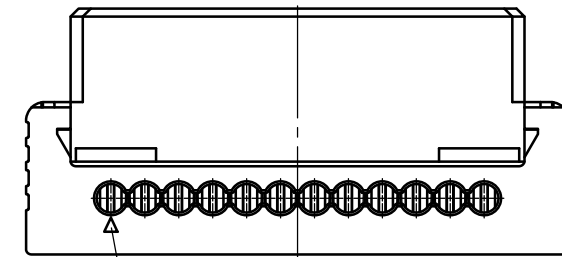

Kontaktbezeichnung  
contact marking

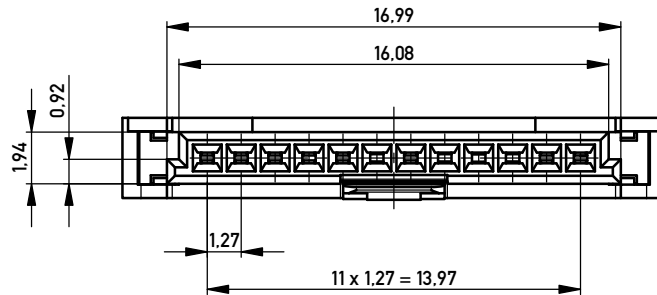

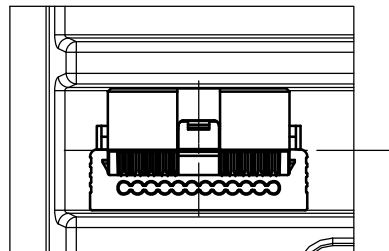

Einzelheit X - detail X  
M 2:1

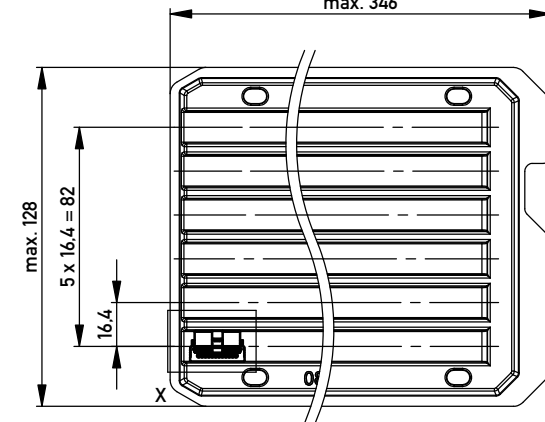

Verpackt in Tray - tray packaging  
Verpackungseinheit 90 Stück - packaging unit 90 pcs  
max. 346



Information: ohne Hilfsmittel lösbar without tool unlockable  All rights reserved. Only for Information. To ensure that this is the latest version of this drawing, please contact one of the ERNI companies before using.	Tolerances  All Dimensions in mm	Scale 5:1	
		Designation <b>1,27 SRC P SKV, 12-polig</b> <b>1,27 SRC P IDC, 12-pin</b>	
	 www.ERNI.com	<b>234480</b>	I <b>A3</b>
a	01.04.2010	Class SRCP	
Index	Date		

Copyright by ERNI GmbH  
Proprietary notice pursuant to ISO 9006 to be observed.

# Mouser Electronics

Authorized Distributor

Click to View Pricing, Inventory, Delivery & Lifecycle Information:

[ERNI Electronics:](#)

[234480](#)