

Schnitt A-A /  
cross section A-A

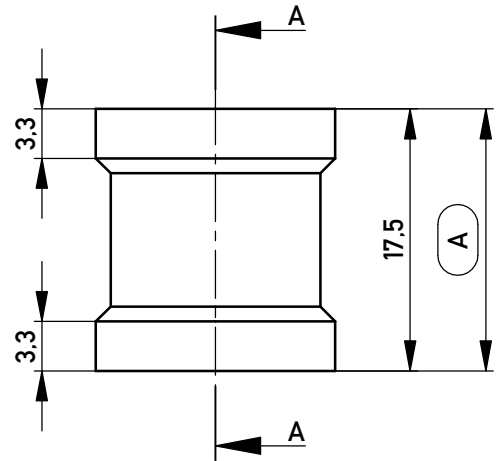

Layout - Vorschlag  
PCB - Layout proposal  
M 1:1  
scale 1:1

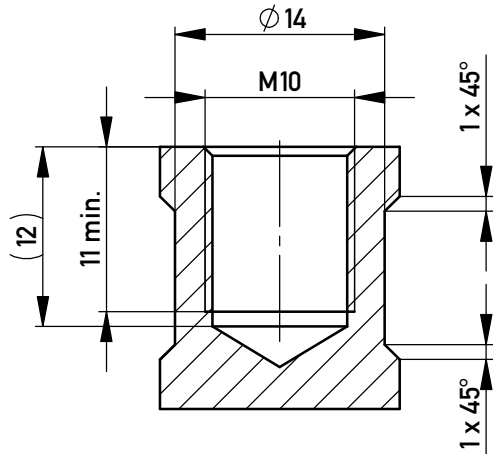

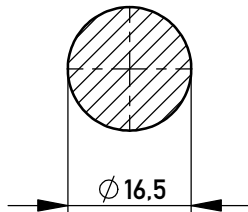

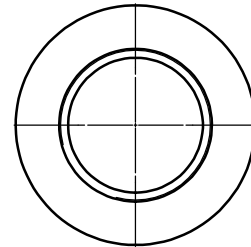
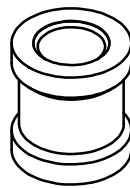
M 1:1 / scale 1:1



5-10 $\mu$ m Sn matt über 1-3 $\mu$ m Ni /  
5-10 $\mu$ m sn matt over 1-3 $\mu$ m ni

Oberfläche (A) / plating (A)

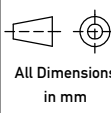
Copyright by ERNI Production GmbH & Co. KG  
Proprietary notice pursuant to ISO 16016 to be observed.

Information:		Tolerances	 All Dimensions in mm	Scale: 2:1	
All rights reserved. Only for Information. To ensure that this is the latest version of this drawing, please contact one of the ERNI companies before using.		Subject to modification without prior notice. Drawing will not be updated.		Material: CuZn39Pb3	Designation
 www.ERNI.com		225861			I A4
b	09.05.2017	Class POWELM			
Index	Date				

# Mouser Electronics

Authorized Distributor

Click to View Pricing, Inventory, Delivery & Lifecycle Information:

[ERNI Electronics:](#)

[225861](#)