

Schnitt A-A /
cross section A-A

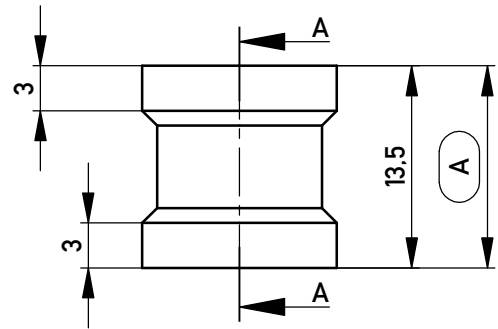

Layout - Vorschlag
PCB - Layout proposal
M 1:1
scale 1:1

M 1:1 / scale 1:1

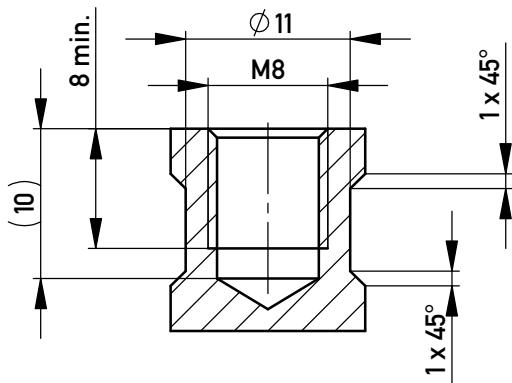
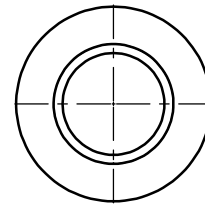
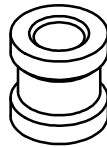
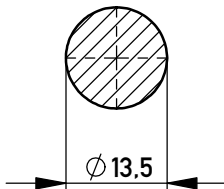

5-10 μ m Sn matt über 1-3 μ m Ni /
5-10 μ m sn matt over 1-3 μ m ni

Oberfläche (A) / plating (A)

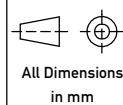
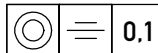

Scale 2:1

Material: CuZn39Pb3

Designation

PowerElement SMD
female thread M8

Information:

All rights reserved.
Only for Information.
To ensure that this is the latest
version of this drawing, please
contact one of the ERNI companies
before using.

Subject to modification without
prior notice.
Drawing will not be updated.



www.ERNI.com

225860

I
A4

b	09.05.2017
Index	Date

Class POWELM

Copyright by ERNI Production GmbH & Co. KG
Proprietary notice pursuant to ISO 16016 to be observed.

Mouser Electronics

Authorized Distributor

Click to View Pricing, Inventory, Delivery & Lifecycle Information:

[ERNI Electronics:](#)

[225860](#)