

Attachment, Connector Coding & Locking Specification

Connector #1

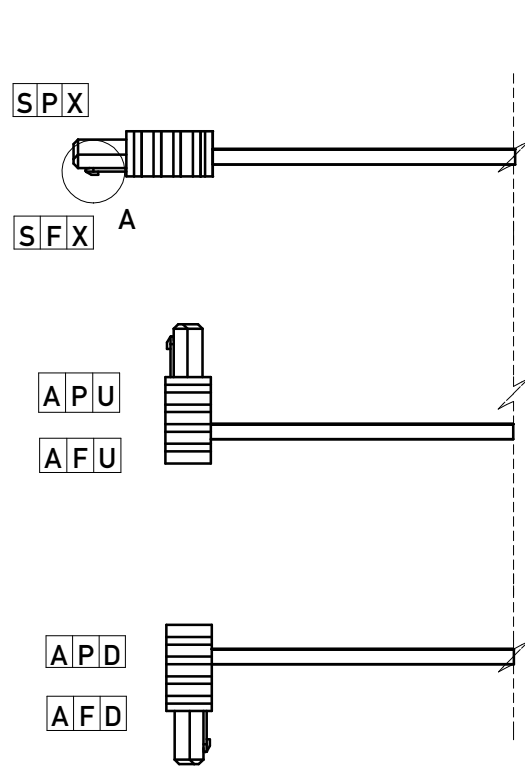

Connector #2

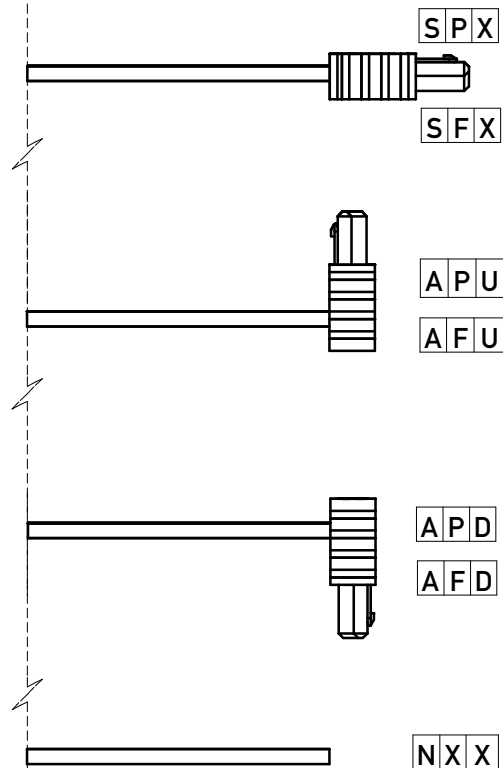

Connector typical dimension

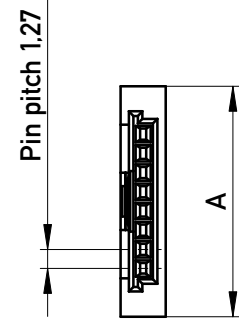

No. of Pin	Dim A
2	7.62
3	8.89
4	10.16
6	12.7
8	15.24
10	17.78
12	20.32

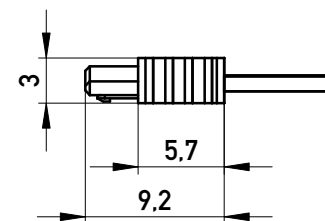
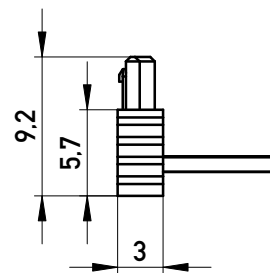

Wire Counting & Ribbon Cable Specification

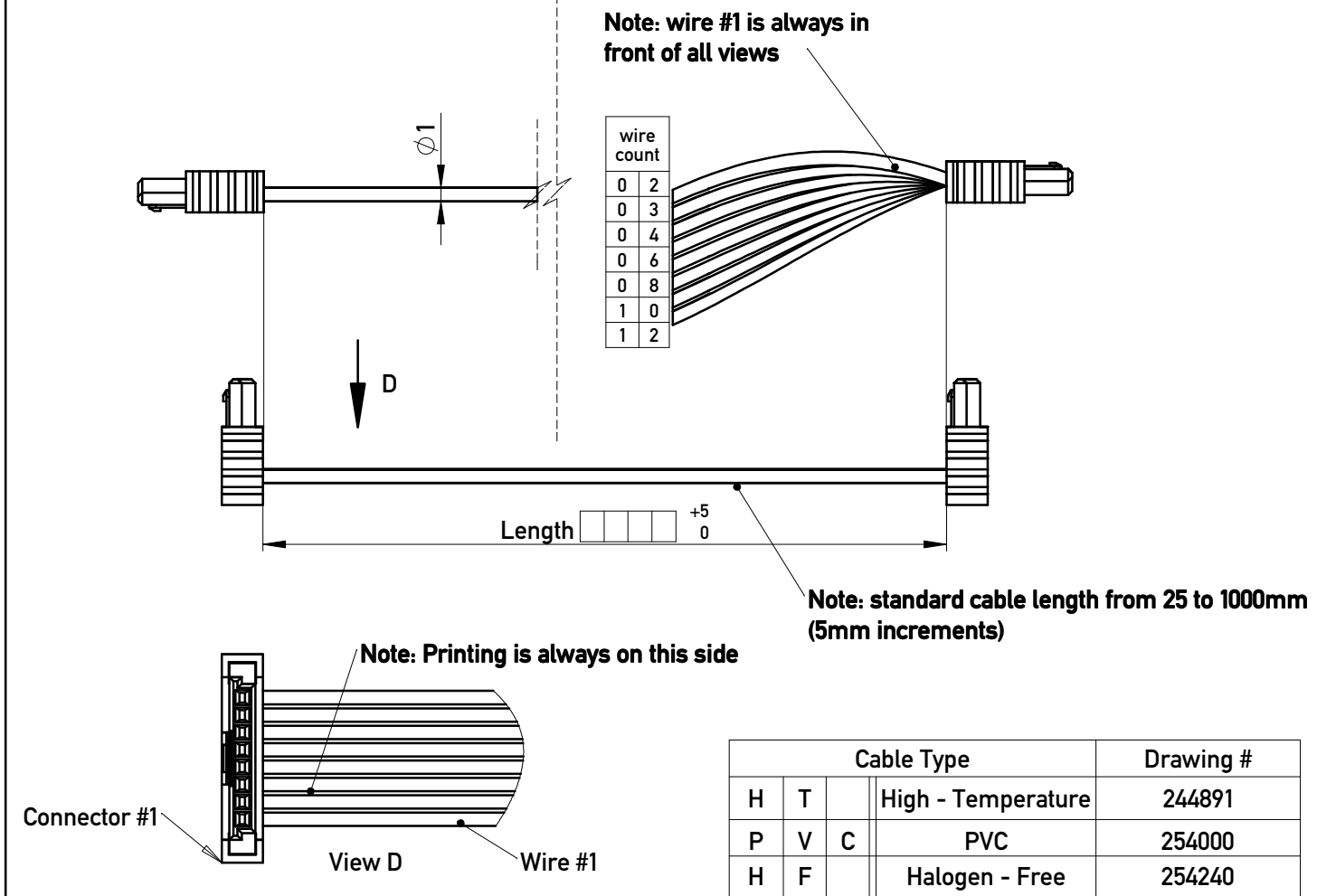

Product Code

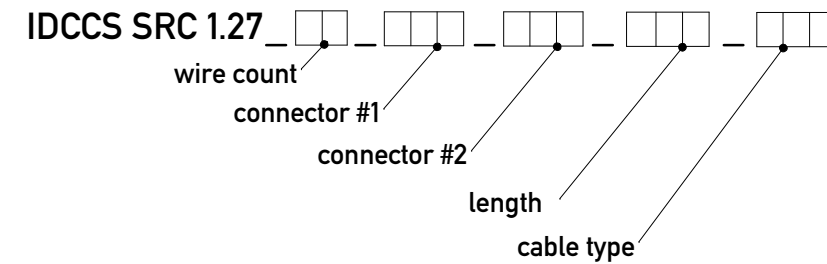

[F] Friction lock
unlockable without tool

DETAIL A Positive lock
unlockable only with tool

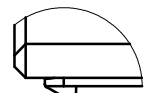

Locking latch

Note: please consider the correct orientation of the locking latch in all views!

Copyright by ERNI GmbH
Proprietary notice pursuant to ISO 16016 to be observed.

Information:	Tolerances	All Dimensions in mm	Scale 2:1	Sheet 1/2
All rights reserved. Only for Information. To insure that this is the latest version of this drawing, please contact one of the ERNI companies before using.	Subject to modification without prior notice. Drawing will not be updated.	Designation		
www.ERNI.com		MiniBridge Flat Cable Assemblies		
		839000		I A3
		Class IDCCS		

Connector Part Number to Connector Coding Crossreference

Wire Count	Part No Cable Connector	Connector Coding	
		Connector #1	Connector #2
2	224393	AFU/AFD	AFU/AFD
2	214015	APU/APD	APU/APD
2	224397	SFX	SFX
2	214157	SPX	SPX
3	234452	AFU/AFD	AFU/AFD
3	234451	APU/APD	APU/APD
3	234459	SFX	SFX
3	234458	SPX	SPX
4	224394	AFU/AFD	AFU/AFD
4	214025	APU/APD	APU/APD
4	224398	SFX	SFX
4	214049	SPX	SPX
6	224395	AFU/AFD	AFU/AFD
6	214038	APU/APD	APU/APD
6	224399	SFX	SFX
6	214158	SPX	SPX
8	224396	AFU/AFD	AFU/AFD
8	214039	APU/APD	APU/APD
8	224400	SFX	SFX
8	214159	SPX	SPX
10	234466	AFU/AFD	AFU/AFD
10	234465	APU/APD	APU/APD
10	234473	SFX	SFX
10	234472	SPX	SPX
12	234480	AFU/AFD	AFU/AFD
12	234479	APU/APD	APU/APD
12	234487	SFX	SFX
12	234486	SPX	SPX

Note: please use product code (as shown in drawing 839000 sheet 1/2) also for inquiries differing to the standard cable assemblies. A partnumber will be assigned during series order!

Information:

Tolerances

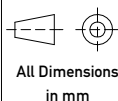

Sheet 2/2

All rights reserved.
Only for Information.
To insure that this is the latest version of this drawing, please contact one of the ERNI companies before using.

Subject to modification without prior notice.
Drawing will not be updated.

Designation

**MiniBridge
Flat Cable Assemblies**



www.ERNI.com

839000

I
A4

Class

Mouser Electronics

Authorized Distributor

Click to View Pricing, Inventory, Delivery & Lifecycle Information:

[ERNI Electronics:](#)

[839307](#)