

MAXQ7667 Evaluation Kit

Evaluates: MAXQ7667

General Description

The MAXQ7667 evaluation kit (EV kit) is a convenient platform to evaluate the capabilities of the MAXQ7667 ultrasonic distance-measuring microcontroller (μ C). The EV kit contains all the hardware needed to interface to a PC and run demo application software. In addition to the MAXQ7667 microcontroller, the EV kit also includes an ultrasonic transducer with drive transformer, external temperature sensor, SPI™ E²PROM for nonvolatile storage, and a LIN transceiver for connecting to automotive networks.

MAXQ7667 EV Kit Contents

- ◆ MAXQ7667 EV Kit PCB
- ◆ RS-232 Serial-Port Cable for Programming and Debugging
- ◆ 12V, 1.5A DC Power Supply
- ◆ MAXQ7667 EV Kit Quick-Start CD

Features

- ◆ MAXQ7667 16-Bit RISC μ C
 - 32KB (16K x 16) Flash Memory
 - 4096 Bytes (2048 x 16) Data RAM
- ◆ Ultrasonic Transducer with Drive Transformer
- ◆ UART/LIN Physical Interface
 - RS-232
 - RS-485
 - LIN
- ◆ 4KB SPI E²PROM
- ◆ External 2.5V Voltage Reference
- ◆ External Temperature Sensor
- ◆ Serial- or USB-to-JTAG Interface for Program/Debug
- ◆ External Power Supplies with Brownout

Ordering Information

PART	PC INTERFACE	INTERFACE TYPE*
MAXQ7667EVKIT#	RS-232 or USB	Windows®

#Denotes RoHS compliant.

*Tested under Windows XP®.

Component List

DESIGNATION	QTY	DESCRIPTION
C1, C2, C3, C5, C17, C26, C27, C33–C36, C38, C42–C46, C51, C52, C55, C56, C61	22	0.1 μ F +80/-20%, 50V ceramic capacitors (0805) KEMET C0805C104Z5UACTU
C4, C6, C9, C12, C25, C60	6	0.01 μ F +80/-20%, 50V ceramic capacitors (0805) KEMET C0805C103Z5UACTU
C7, C47	2	470pF \pm 5%, 630V ceramic capacitors (1206) TDK C3216C0G2J471J

DESIGNATION	QTY	DESCRIPTION
C8, C14, C16, C18, C19, C22	6	1 μ F \pm 10%, 16V solid tantalum capacitors (3216-18) KEMET T491A105K016AT
C10, C23	2	22 μ F \pm 20%, 10V solid tantalum capacitors (3216-18) KEMET T494A226M010AT
C11, C24, C30, C71	4	22pF \pm 5%, 50V ceramic capacitors (0805) KEMET C0805C220J5GACTU
C13, C20	2	10 μ F \pm 10%, 16V solid tantalum capacitors (6032-28) KEMET T491C106K016AT

SPI is a trademark of Motorola, Inc.

Windows and Windows XP are registered trademarks of Microsoft Corp.

For pricing, delivery, and ordering information, please contact Maxim Direct at 1-888-629-4642, or visit Maxim's website at www.maximintegrated.com.

MAXQ7667 Evaluation Kit

Evaluates: MAXQ7667

Component List (continued)

DESIGNATION	QTY	DESCRIPTION
C15	1	47pF ±5%, 50V ceramic capacitor (0805) KEMET C0805C470J5GACTU
C21	1	4.7µF ±10%, 10V solid tantalum capacitor (3216-18) KEMET T491A475K010AT
C28, C39	2	470pF ±5%, 50V ceramic capacitors (0805) KEMET C0805C471J5GACTU
C29	1	0.033µF ±10%, 50V ceramic capacitor (0805) KEMET C0805C333K5RACTU
C31, C32	0	Not installed, ceramic capacitors
C37	1	100µF ±20%, 20V solid tantalum capacitor (7343-43) KEMET T491X107M020AT
C40, C41	2	3300pF ±5%, 630V ceramic capacitors (1206) TDK C3216C0G2J332J
C53	1	330pF ±5%, 50V ceramic capacitor (0805) KEMET C0805C331J5GACTU
C54	1	1.5µF ±10%, 16V solid tantalum capacitor (3216-18) KEMET T491A155K016AT
C57, C58, C59	3	1µF ±10%, 16V ceramic capacitors (0805) KEMET C0805C105K4RACTU
D1, D2, D13	3	Green LEDs (1206) Lite-On LTST-C150GKT
D3, D4, D5, D10	4	MBRS140T3 SMB Schottky diodes ON Semi MBRS140T3G
D6	1	Red LED (1206) Lite-On LTST-C150CKT
D8	1	1SMC12AT3G SMC transient voltage suppressor ON Semi 1SMC12AT3G
D9	1	Amber LED (1206) Lite-On LTST-C150AKT

DESIGNATION	QTY	DESCRIPTION
D12	1	BAS28 SOT-143 high-speed dual diode Philips BAS28
F1	1	125V, 4A fast-acting fuse Littlefuse 0459004.UR
J8	1	USB type-B PC-mount connector Kobiconn 154-2442-E
J13, J22, J23	3	PC-mount connectors (DB-9) Norcomp, Inc. 182-009-213R181
J18	1	Dual-row, 5-pin, 0.1in connector Molex 90131-0765
J24	1	2.5mm ID, 5.5mm OD power jack CUI, Inc. PJ-102B
JU1, JU9, JU10, JU24, JU30, JU51, JU52, JU54, JU59, JU67, JU69, JU80, JU103–JU108, JU222	19	2-pin, 0.1in headers Sullins PEC36SAAN
JU2, JU3, JU5, JU6, JU13, JU14, JU15, JU17, JU19, JU22, JU31, JU34, JU35, JU36, JU38, JU40, JU41, JU46–JU50, JU82–JU87, JU207–JU210, JU212, JU213, JU235	0	Not installed, 2-pin, 0.in headers—short (PC trace)
JU4, JU7, JU8, JU11, JU12, JU16, JU21, JU25, JU29, JU33, JU71	11	3-pin, 0.1in headers Sullins PEC36SAAN

MAXQ7667 Evaluation Kit

Evaluates: MAXQ7667

Component List (continued)

DESIGNATION	QTY	DESCRIPTION
Q1	1	n-channel MOSFET (SOT23) Zetex 2N7002TA
Q2	1	n-channel MOSFET (SOT23) Infineon BSP129E6327T
Q4	1	n-channel MOSFET (6 SuperSOT) Fairchild FDC653N
R1, R26, R33	3	47.5k Ω \pm 1% precision thick-film chip resistors (0805) Panasonic ERJ-6ENF4752V
R2	1	86.6k Ω \pm 1% precision thick-film chip resistor (0805) Panasonic ERJ-6ENF8662V
R3	1	10k Ω \pm 10% NTC thermistor (0805) Murata NCP21XV103J03RA
R4, R5, R7, R20, R22, R23, R32, R35, R39, R44, R46, R47	12	10k Ω \pm 1% precision thick-film chip resistors (0805) Panasonic ERJ-6ENF1002V
R6	1	42.2k Ω \pm 1% precision thick-film chip resistor (0805) Panasonic ERJ-6ENF4222V
R8, R24, R38, R43	4	432 Ω \pm 1% precision thick-film chip resistors (0805) Panasonic ERJ-6ENF4320V
R9, R19, R30	3	20k Ω \pm 1% precision thick-film chip resistors (0805) Panasonic ERJ-6ENF2002V
R10	1	0.1 Ω \pm 5% precision thick-film chip resistor (0805) Panasonic ERJ-6RSJR10V
R11, R40, R41, R42	4	0 Ω \pm 5% precision thick-film chip resistors (0805) Panasonic ERJ-6GEY0R00V
R12	1	24.3k Ω \pm 1% precision thick-film chip resistor (0805) Panasonic ERJ-6ENF2432V
R13	1	30.1k Ω \pm 1% precision thick-film chip resistor (0805) Panasonic ERJ-6ENF3012V
R14	1	196k Ω \pm 1% precision thick-film chip resistor (0805) Panasonic ERJ-6ENF1963V

DESIGNATION	QTY	DESCRIPTION
R15	1	10 Ω \pm 1% precision thick-film chip resistor (0805) Panasonic ERJ-6ENF10R0V
R16	1	31.6k Ω \pm 1% precision thick-film chip resistor (0805) Panasonic ERJ-6ENF3162V
R17	1	178k Ω \pm 1% precision thick-film chip resistor (0805) Panasonic ERJ-6ENF1783V
R18, R36, R37	3	33.2k Ω \pm 1% precision thick-film chip resistors (0805) Panasonic ERJ-6ENF3322V
R21	1	49.9 Ω \pm 1% precision thick-film chip resistor (1210) Panasonic ERJ-14NF49R9U
R25	1	3.24k Ω \pm 1% precision thick-film chip resistor (0805) Panasonic ERJ-6ENF3241V
R27, R29, R45	3	1k Ω \pm 1% precision thick-film chip resistors (0805) Panasonic ERJ-6ENF1001V
R28	1	1.05k Ω \pm 1% precision thick-film chip resistor (0805) Panasonic ERJ-6ENF1051V
R31	1	68.1k Ω \pm 1% precision thick-film chip resistor (0805) Panasonic ERJ-6ENF6812V
R34	1	332 Ω \pm 1% precision thick-film chip resistor (1210) Panasonic ERJ-14NF3320U
SW1–SW8	8	Momentary PCB switches Omron B3S-1000
T1	1	Transformer Advantage TMS Inc. K4000004
U1, U3	2	LDO linear regulators (5 SOT23) Maxim MAX8863REUK+
U2	1	USB-to-RS-232 transceiver (28 SSOP) FTDI FT232RL
U4	1	RS-232/RS-485 transceiver (24 SSOP) Maxim MAX3161ECAG+

MAXQ7667 Evaluation Kit

Evaluates: MAXQ7667

Component List (continued)

DESIGNATION	QTY	DESCRIPTION
U5	1	LIN interface (8 SO) Maxim MAX13020ASA+
U7	1	Integrated ultrasonic distance-measuring μ C (48 LQFP) Maxim MAXQ7667AACM/V+
U9, U25	2	Linear voltage regulators (8 SO-EP*) Maxim MAX5024LASA+
U10	1	SPI serial E ² PROM 4096 x 8 (8 SO) Atmel AT25320AN-10SU-2.7
U11	1	SPI DAC (6 SOT23) Maxim MAX5384EUT+
U15	1	Quad three-state bus driver (14 TSSOP) Toshiba TC74VHC125FTTR
U18	1	Flash μ C (44 TQFP) Maxim DS89C430-ENL+
U19	1	Comparator (5 SOT23) Maxim MAX9140EUK+
U20	1	Analog switch (16 TSSOP) Maxim MAX4619EUE+T

DESIGNATION	QTY	DESCRIPTION
U22	1	RS-232 transceiver (20 SO) Maxim MAX203ECWP+G36
U26	1	2.5V voltage reference (8 SO) Maxim MAX6126AASA25+
U29	1	Octal buffer/driver with three-state outputs (20 SOP) Texas Instruments SN74LV244ANSR
X8	1	Ultrasonic transducer Advantage TMS Inc. 400EP250250B
Y3	1	16MHz ceramic resonator ECS CSTCE16M0V53-R0
Y5	1	7.3728MHz, 19A surface-mount crystal ECS ECS-73-20-19A-TR
—	22	Shunts (see Table 1) Kycon S1100-B or equivalent
—	1	PCB: MAXQ7667 EVALUATION KIT#

+Denotes lead(Pb)-free and RoHS compliant.

/V denotes an automotive qualified part.

*EP = Exposed pad.

Detailed Description of Hardware

MAXQ7667

The MAXQ7667 smart system-on-a-chip (SoC) provides a time-of-flight ultrasonic distance-measuring solution. The MAXQ7667 contains a burst signal generator and echo reception components for processing ultrasonic signals between 25kHz and 100kHz. Controlling all these functions is an embedded 16-bit MAXQ20 microcontroller (μ C). The MAXQ7667 also has a UART/LIN controller for external interfacing. Refer to the MAXQ7667 IC data sheet, application notes, and user's guide available at www.maximintegrated.com for complete details.

Power Supply

The MAXQ7667 EV kit is powered by the external 12V DC power supply that is included in the kit. The external power supply provides power to the voltage regulators used for AVDD, DVDD, and VDDIO. Separate regulators are used to provide brownout voltages by pressing switches for each of the power supplies. The brownout switches verify the MAXQ7667 power-supply voltage monitor functionality when the monitors are enabled.

External Voltage References

The MAXQ7667 EV kit contains an external 2.5V voltage reference. The EV kit can use the AVDD supply (+3.3V) as the voltage reference for the ADC with jumpers.

Temperature Sensors

The MAXQ7667 EV kit contains an external NTC thermistor. The output voltage is measured using an ADC input and the temperature is calculated using the thermistor transfer function.

Utility LEDs

The MAXQ7667 EV kit contains three LEDs (red, amber, and green), which can be configured using general-purpose I/O bits.

SPI E²PROM

The MAXQ7667 contains a master/slave SPI port for communication with devices supporting an SPI interface. The EV kit has 4KB SPI E²PROM.

MAXQ7667 Evaluation Kit

Evaluates: MAXQ7667

UART Interface

The MAXQ7667 contains a UART that can be used to communicate over an RS-232/RS-485 serial link. The EV kit has a transceiver that can be configured with jumpers to interface with the RS-232/RS-485 physical layer.

LIN Interface

The MAXQ7667 UART can also be configured as a LIN interface. The EV kit also has a LIN transceiver that can be configured with jumpers to interface to the LIN physical layer. A 2-pin header is provided for the LIN interface.

Serial-to-JTAG Interface

To program the MAXQ7667 over the JTAG interface, a separate Maxim μ C and peripheral circuitry are included on the EV kit. The PC RS-232 JTAG serial port on the EV kit is used to communicate directly to the MAXQ7667 for erasing and programming of the flash memory. In addition, this interface is used to interface to the IAR Embedded Workbench[®] and other third-party tools for use during debugging.

Default Jumper Settings

The MAXQ7667 has a number of jumpers configured by default to quickly start using the EV kit. The default settings are shown in Table 1. For additional jumper settings, see Figure 2.

Table 1. Factory Jumper Settings

DEFAULT JUMPER SETTING	SHUNT POSITION
JU4, JU7, JU11, JU12, JU16, JU71	2-3
JU7, JU10, JU67, JU69, JU103-JU108, JU222	1-2
JU8, JU18, JU25, JU29, JU33	1-3

SHEET NUMBER	DESCRIPTION
1	MAXQ7667 EVALUATION KIT
2	MAXQ7667
3	MAXQ7667 POWER SUPPLY AND BROWNOUT MONITORS
4	SPI E ² PROM AND TEMPERATURE SENSORS
5	RS-232/RS-485 AND LIN INTERFACES
6	JTAG INTERFACE
7	ULTRASONIC DISTANCE INTERFACE
8	EXTERNAL VOLTAGE REFERENCE AND SPI DAC
9	POWER SUPPLY AND LEDs
10	PROTOTYPE AREA

Figure 1. MAXQ7667 EV Kit Schematic (Sheet 1 of 10)

IAR Embedded Workbench is a registered trademark of IAR Systems AB.

MAXQ7667 Evaluation Kit

Evaluates: MAXQ7667

Pin Name	Direction	Alternate Function
P0.5_T1	Output	Red LED
P0.6_T2	Output	Amber LED
P0.7_T2B	Output	Green LED
P0.2_TXEN	Output	LIN Enable (High)
P0.4_IOB_CMP0	Output	UART Enable (Low)
P0.5_T1	Output	SPI EEPROM CSN
P0.5_T1	Output	SPI DAC CSN

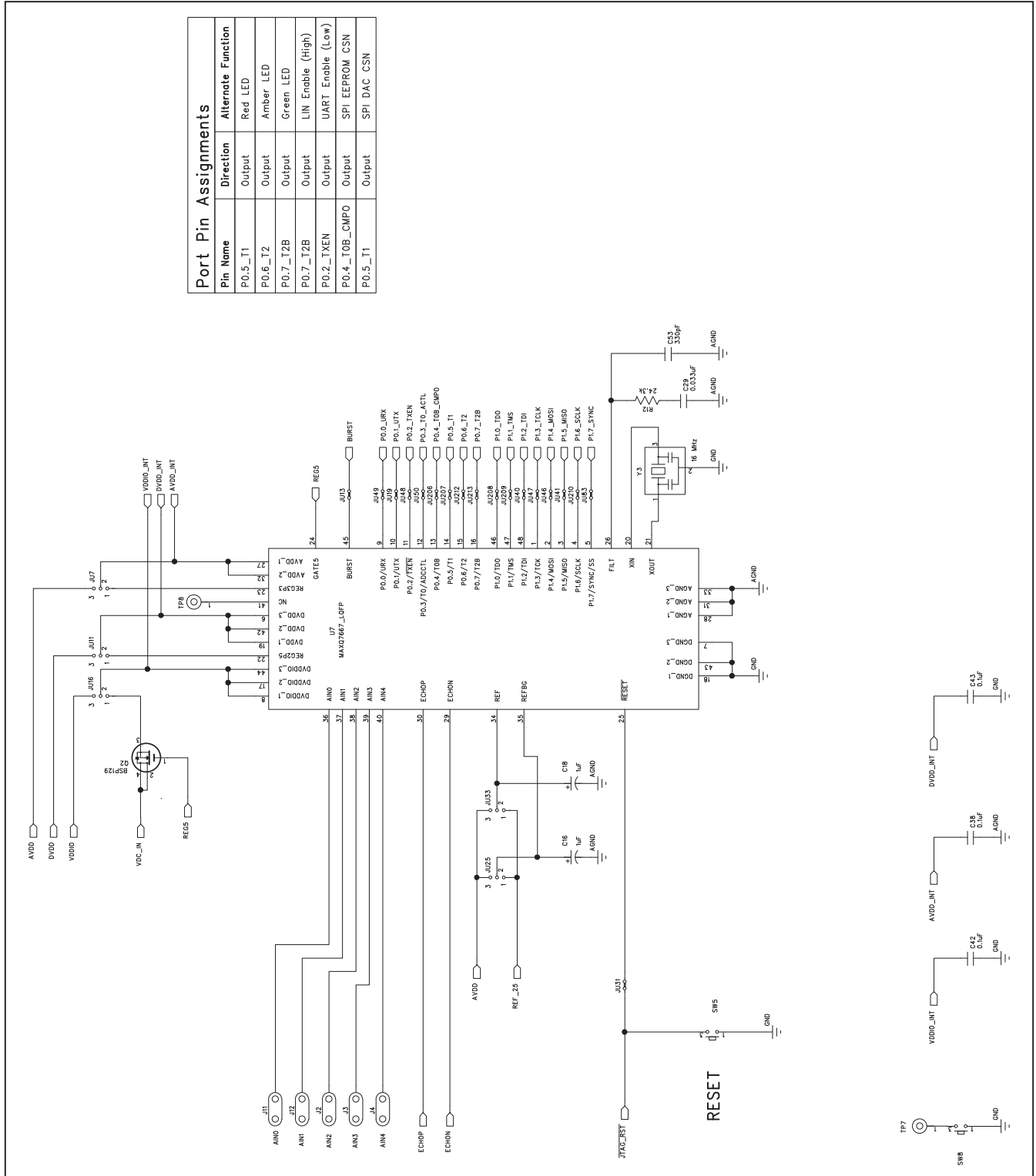

Figure 2. MAXQ7667 EV Kit Schematic (Sheet 2 of 10)

MAXQ7667 Evaluation Kit

Evaluates: MAXQ7667

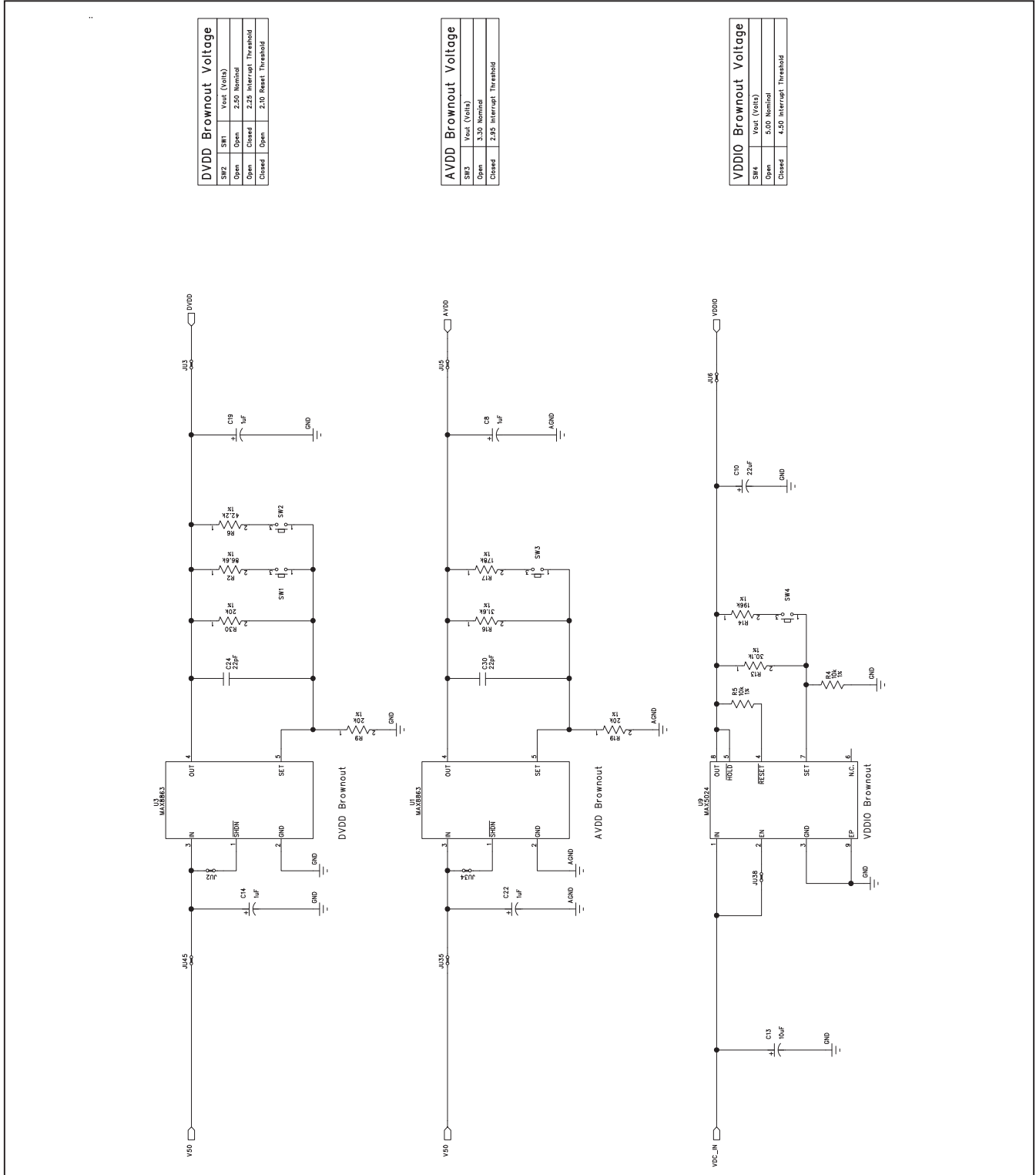
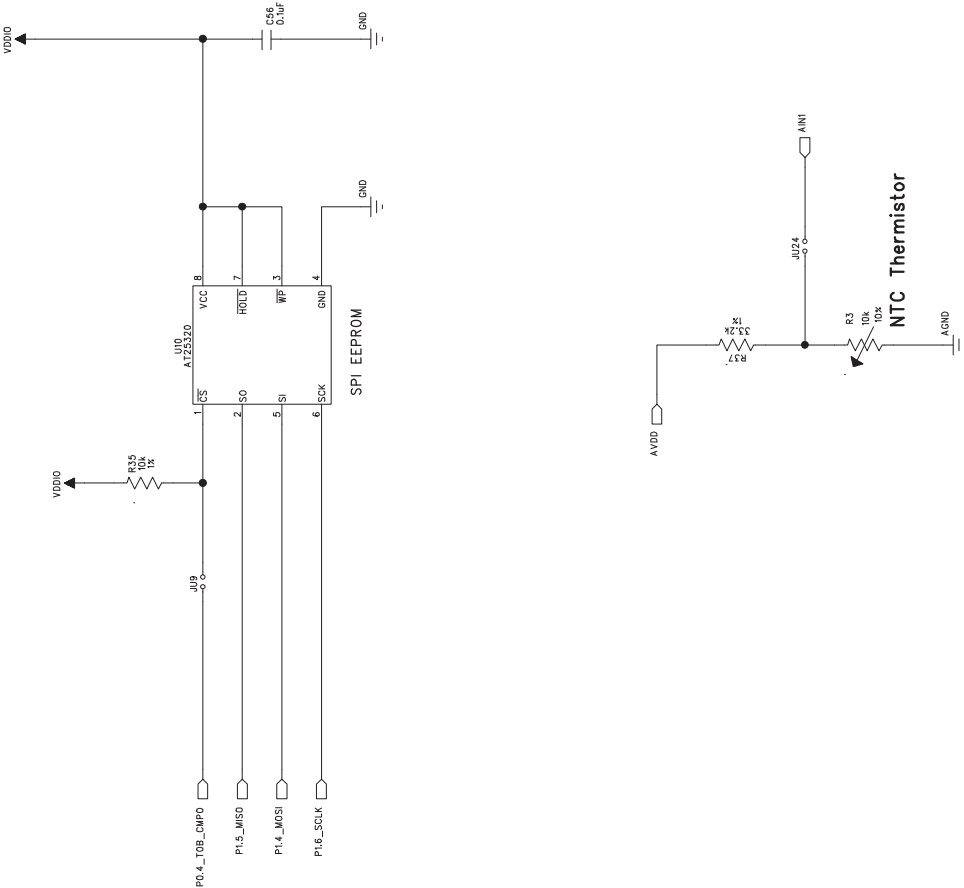

Figure 3. MAXQ7667 EV Kit Schematic (Sheet 3 of 10)

MAXQ7667 Evaluation Kit

Evaluates: MAXQ7667



External Temperature Measurement

Figure 4. MAXQ7667 EV Kit Schematic (Sheet 4 of 10)

MAXQ7667 Evaluation Kit

Evaluates: MAXQ7667

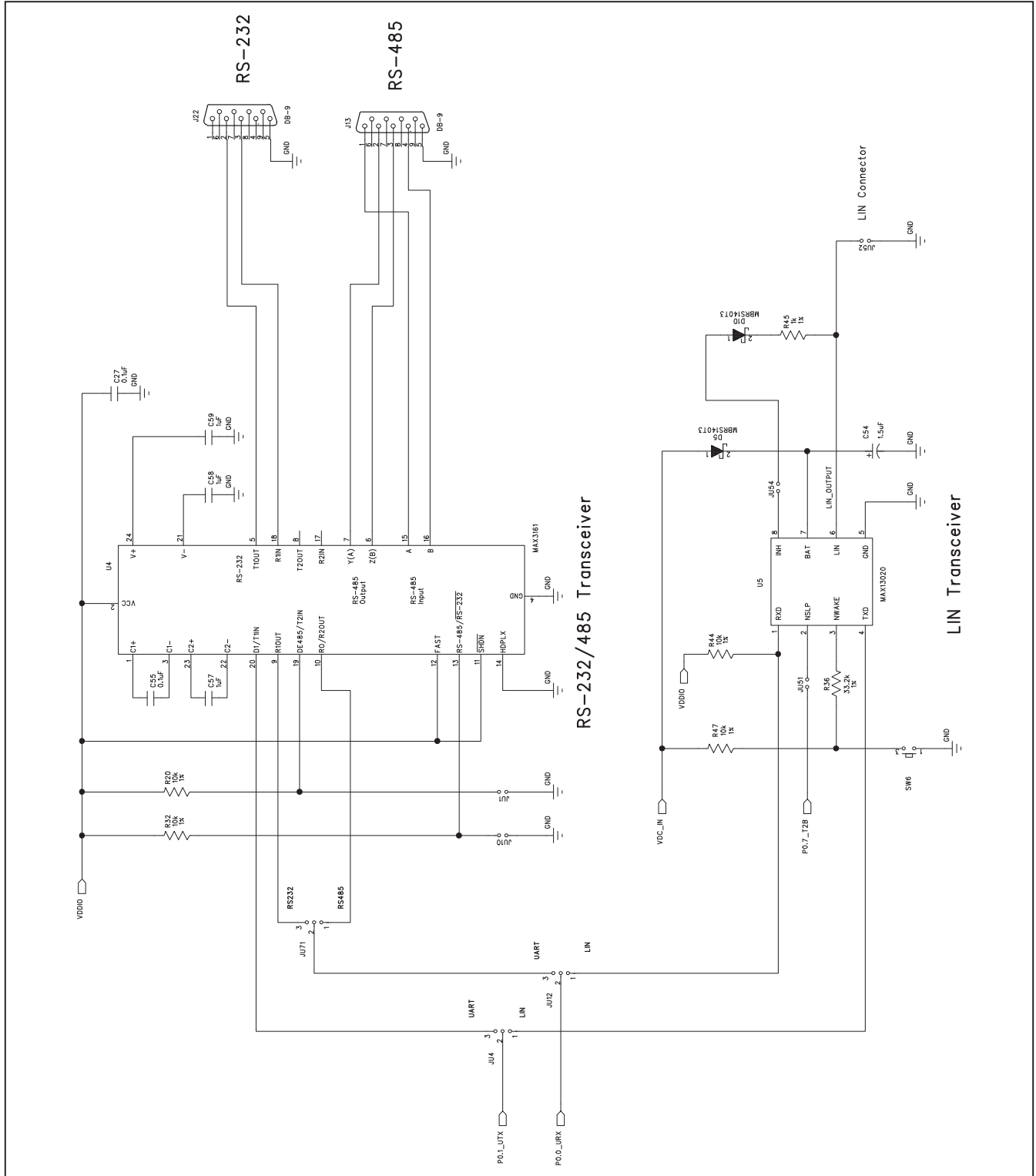

Figure 5. MAXQ7667 EV Kit Schematic (Sheet 5 of 10)

MAXQ7667 Evaluation Kit

Evaluates: MAXQ7667

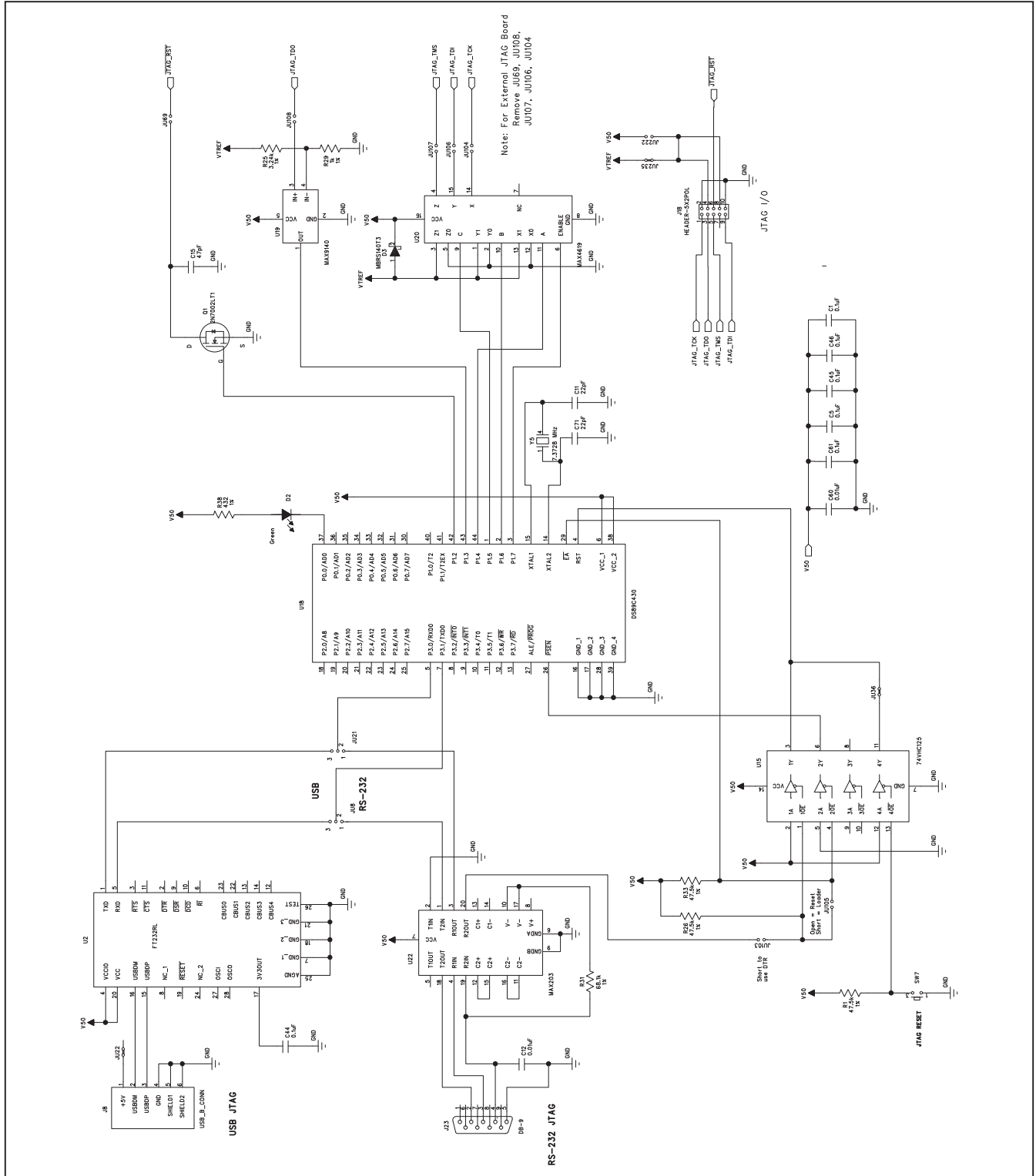

Figure 6. MAXQ7667 EV Kit Schematic (Sheet 6 of 10)

MAXQ7667 Evaluation Kit

Evaluates: MAXQ7667

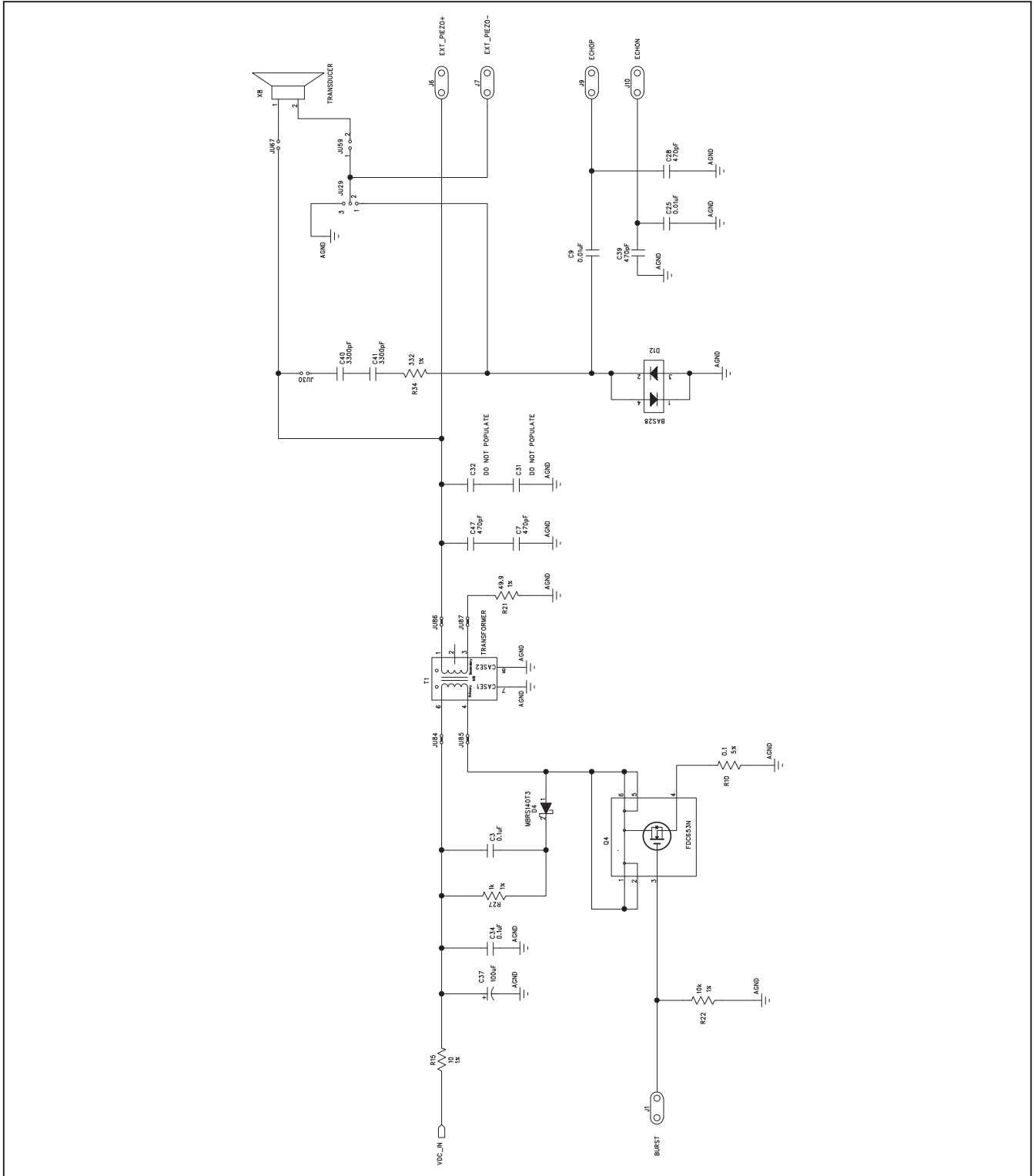

Figure 7 MAXQ7667 EV Kit Schematic (Sheet 7 of 10)

MAXQ7667 Evaluation Kit

Evaluates: MAXQ7667

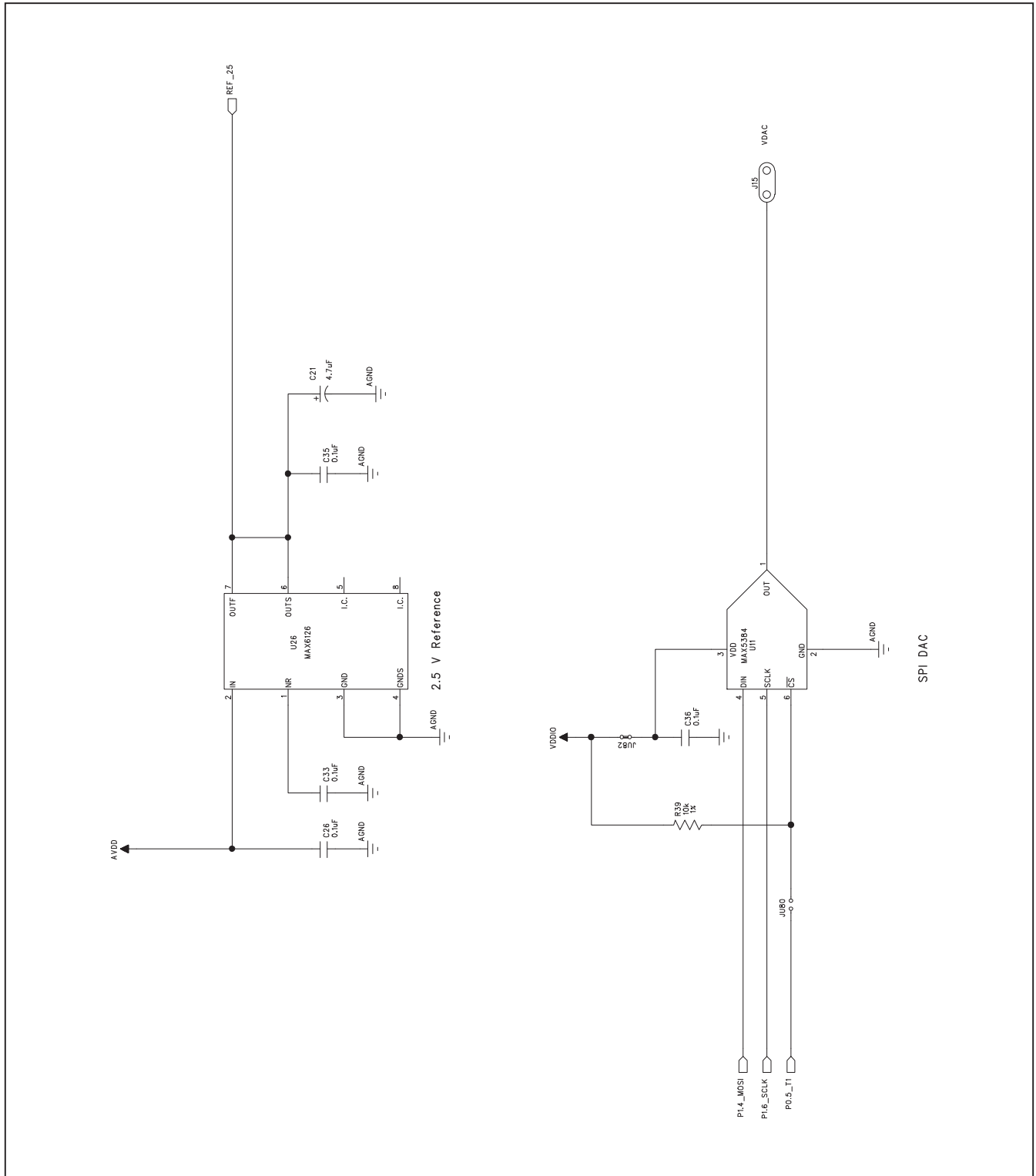

Figure 8. MAXQ7667 EV Kit Schematic (Sheet 8 of 10)

MAXQ7667 Evaluation Kit

Evaluates: MAXQ7667

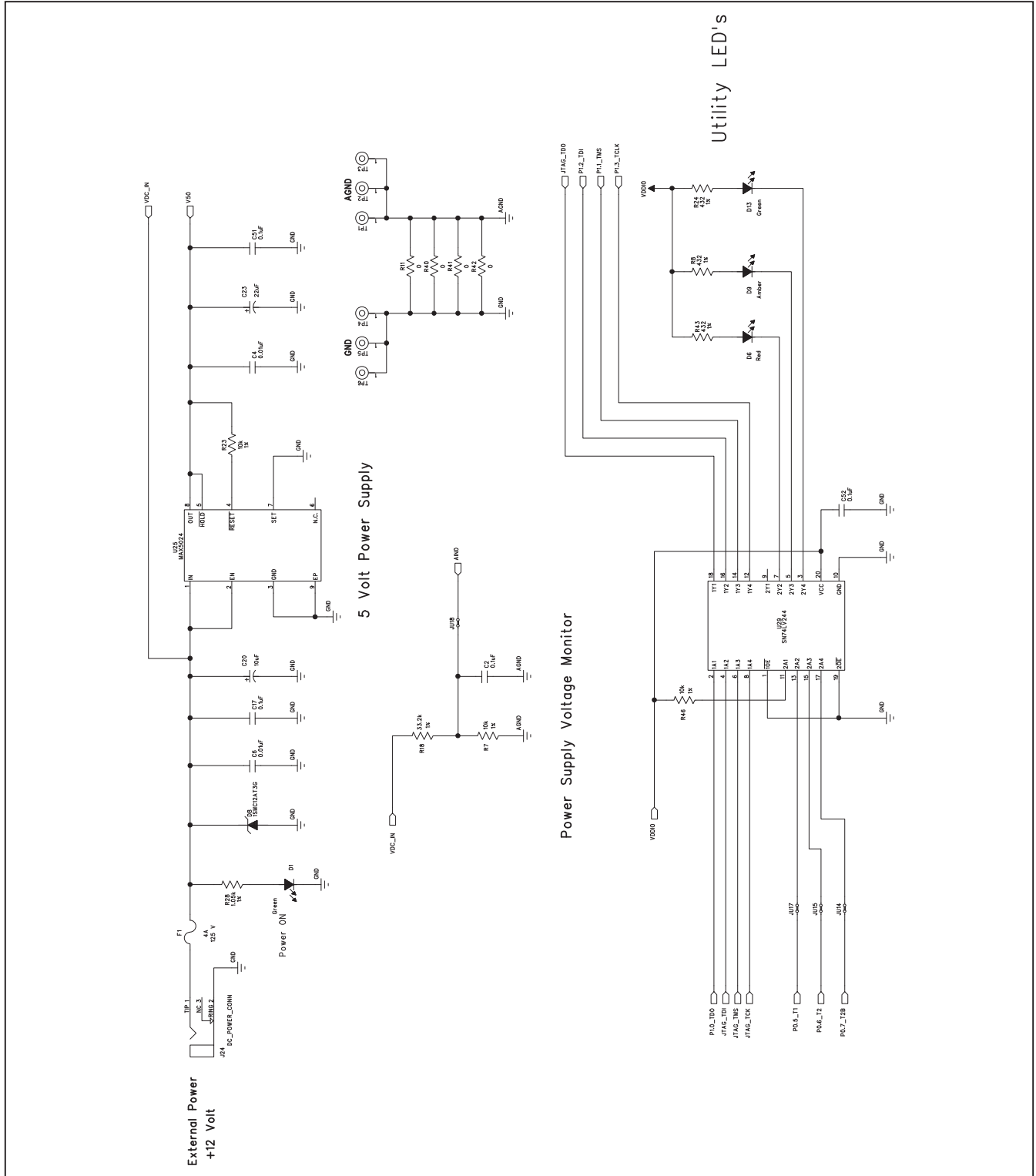

Figure 9. MAXQ7667 EV Kit Schematic (Sheet 9 of 10)

MAXQ7667 Evaluation Kit

Evaluates: MAXQ7667

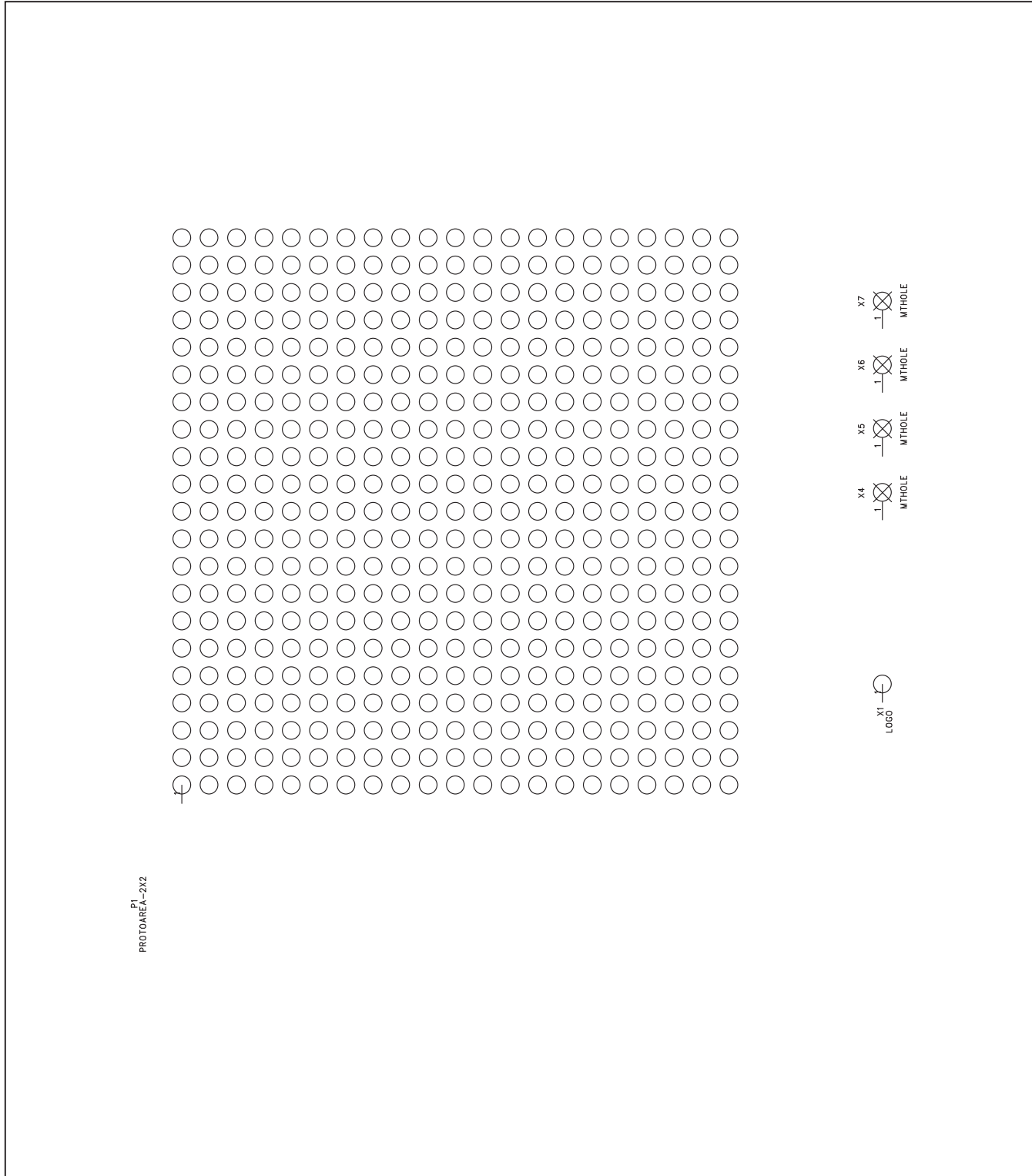

Figure 10. MAXQ7667 EV Kit Schematic (Sheet 10 of 10)

MAXQ7667 Evaluation Kit

Evaluates: MAXQ7667

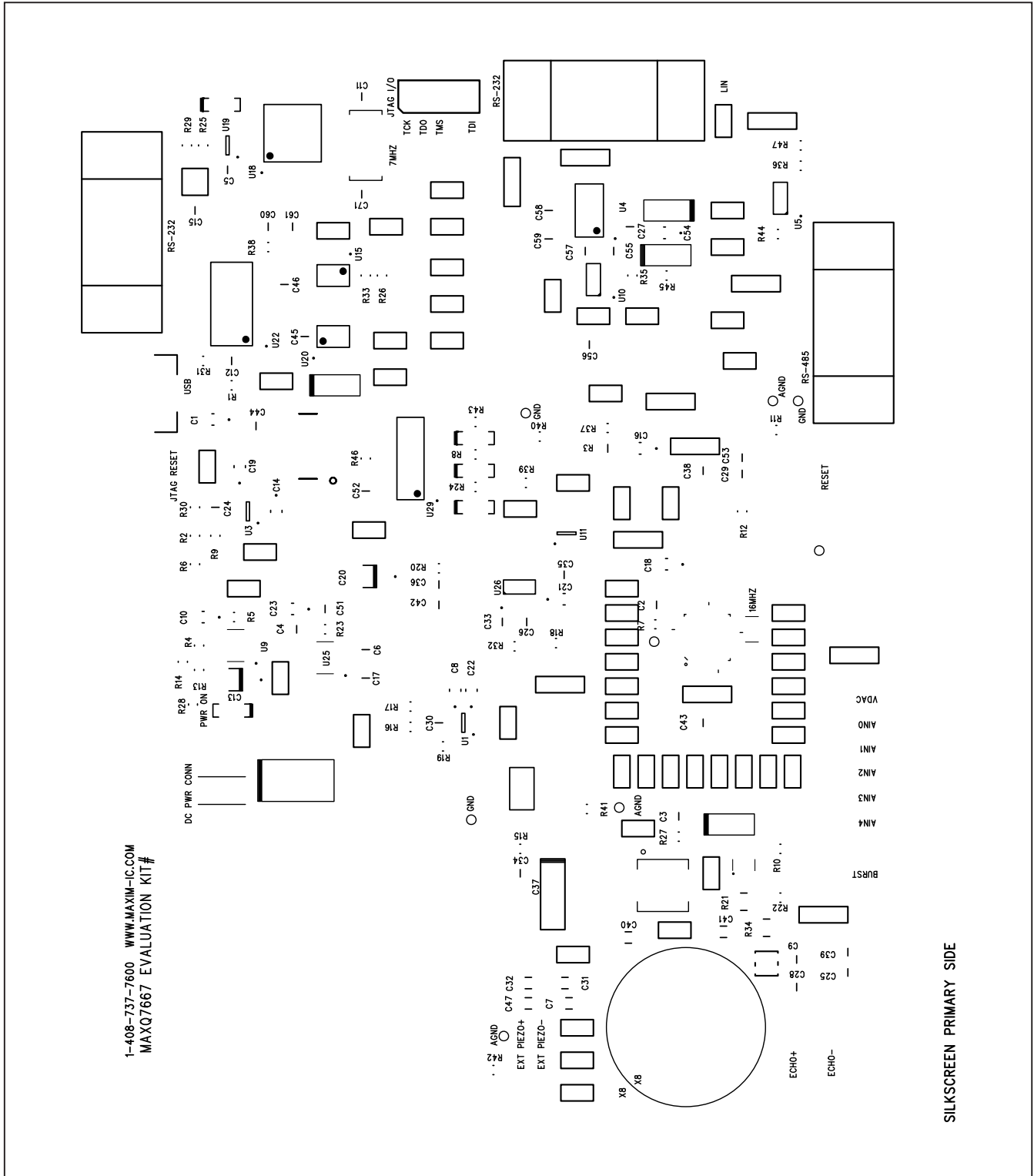

Figure 11. MAXQ7667 EV Kit Component Placement Guide—Top Silkscreen

MAXQ7667 Evaluation Kit

Evaluates: MAXQ7667

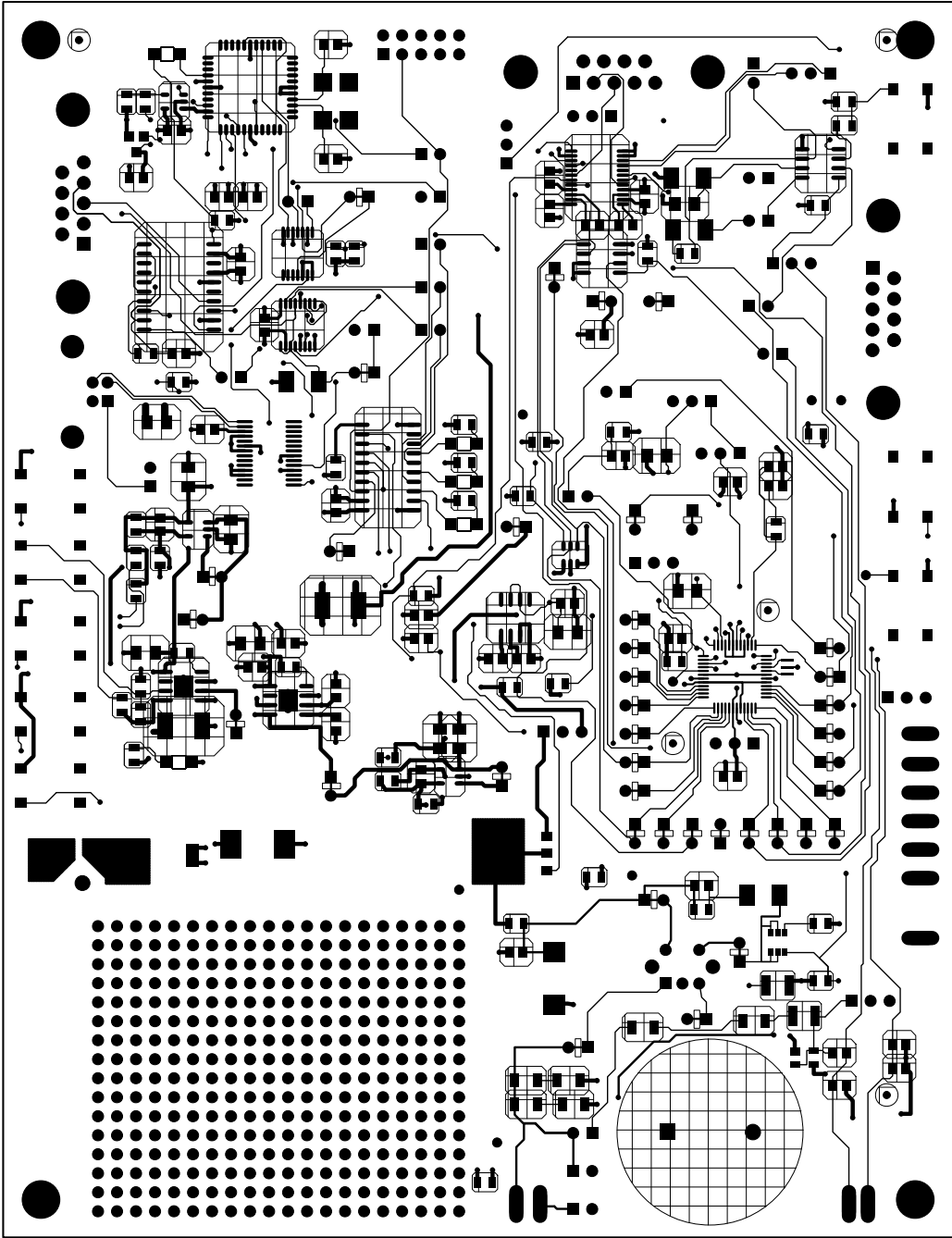

Figure 12. MAXQ7667 EV Kit PCB Layout—Layer 1 (Top)

MAXQ7667 Evaluation Kit

Evaluates: MAXQ7667

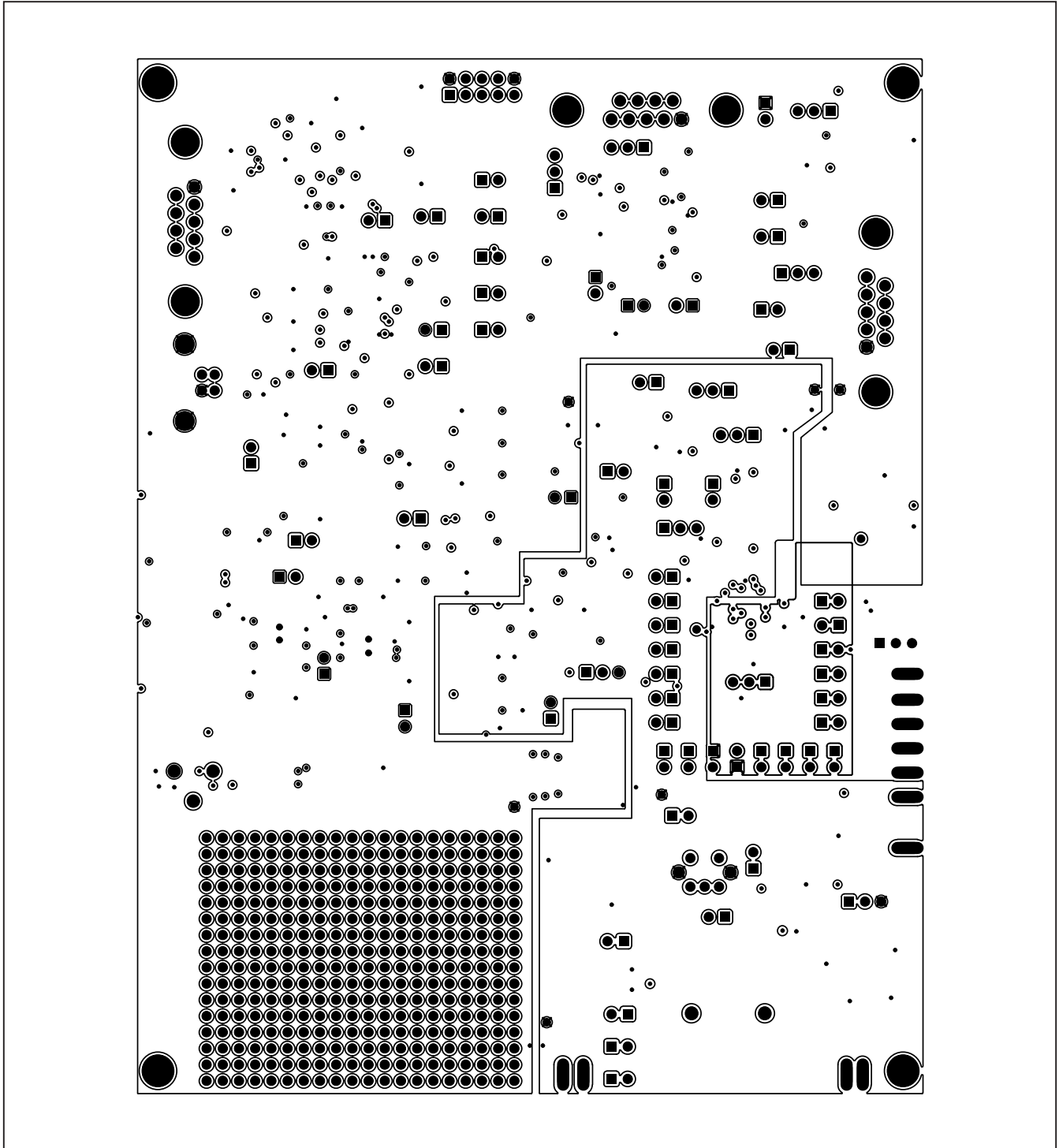

Figure 13. MAXQ7667 EV Kit PCB Layout—Layer 2 (Ground)

MAXQ7667 Evaluation Kit

Evaluates: MAXQ7667

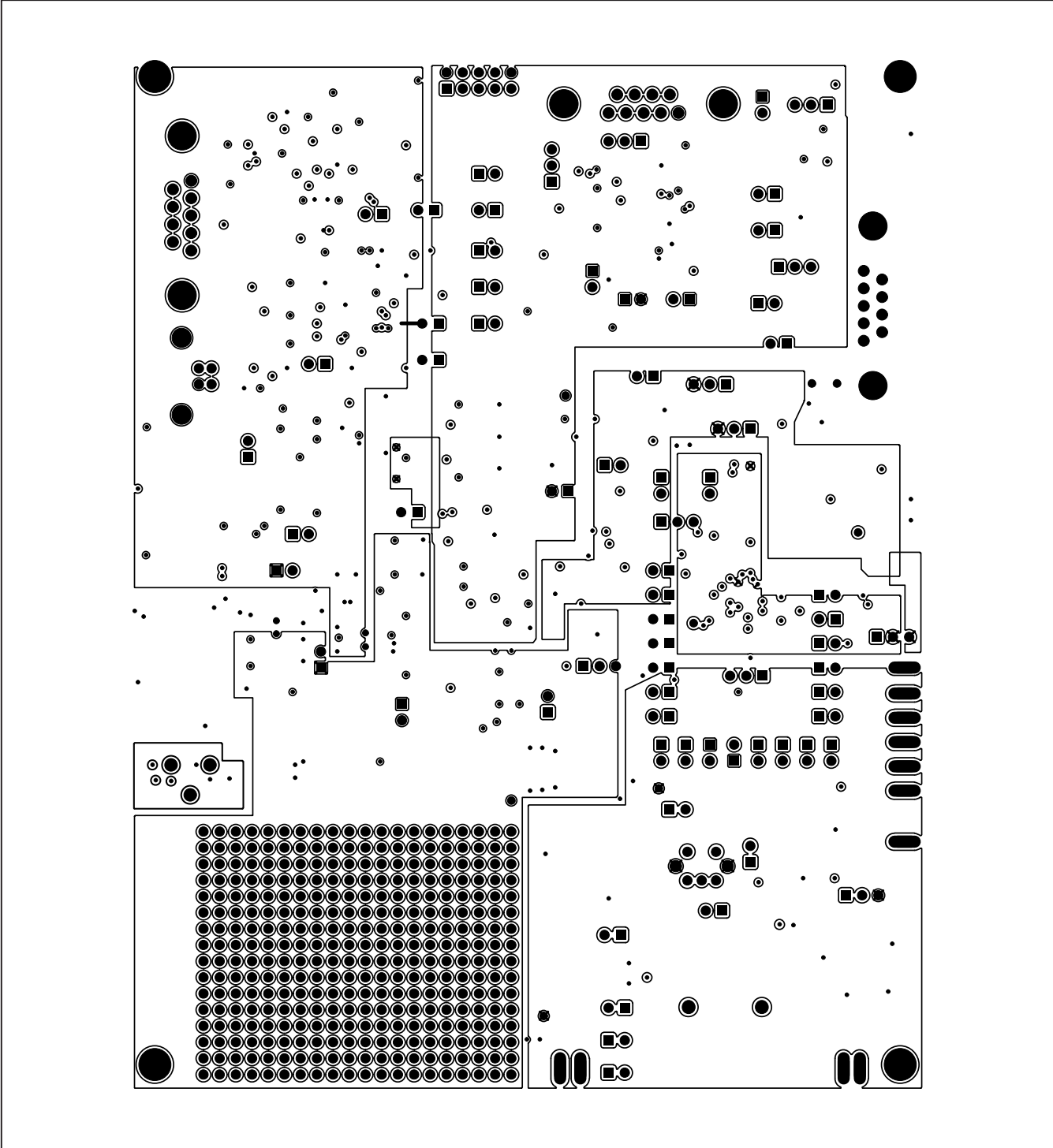

Figure 14. MAXQ7667 EV Kit PCB Layout—Layer 3 (Power)

MAXQ7667 Evaluation Kit

Evaluates: MAXQ7667

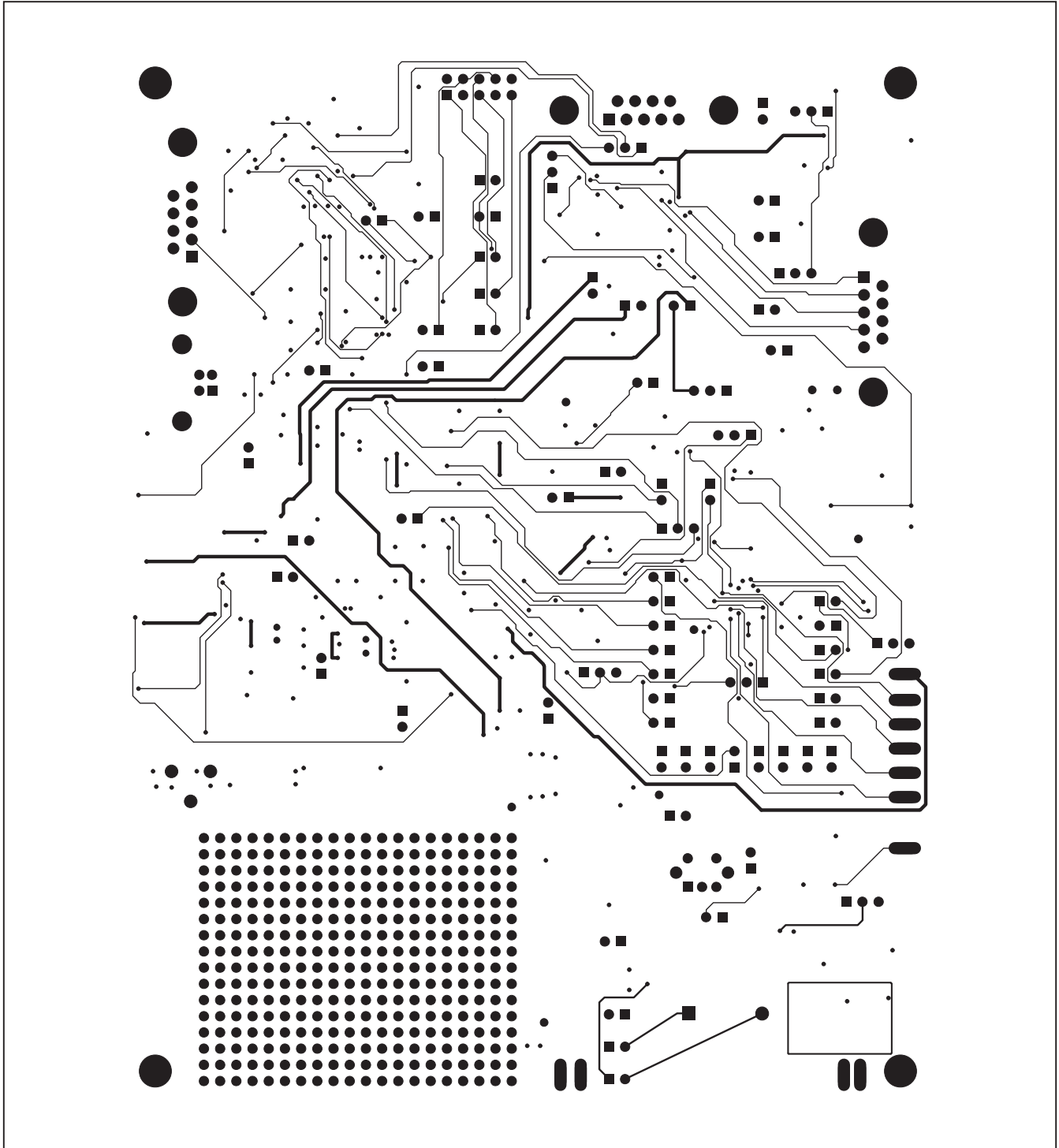

Figure 15. MAXQ7667 EV Kit PCB Layout—Layer 4 (Bottom)

MAXQ7667 Evaluation Kit

Evaluates: MAXQ7667



Maxim Integrated cannot assume responsibility for use of any circuitry other than circuitry entirely embodied in a Maxim Integrated product. No circuit patent licenses are implied. Maxim Integrated reserves the right to change the circuitry and specifications without notice at any time. The parametric values (min and max limits) shown in the Electrical Characteristics table are guaranteed. Other parametric values quoted in this data sheet are provided for guidance.

Mouser Electronics

Authorized Distributor

Click to View Pricing, Inventory, Delivery & Lifecycle Information:

[Analog Devices Inc.:](#)

[MAXQ7667EVKIT+](#)