



GaAs pHEMT MMIC LOW NOISE AMPLIFIER, 28 - 36 GHz

7

AMPLIFIERS - LOW NOISE - SMT

Typical Applications

The HMC566LP4E is ideal for:

- Point-to-Point Radios
- Point-to-Multi-Point Radios & VSAT
- Test Equipment and Sensors
- Military & Space

Features

- Low Noise Figure: 2.8 dB
- High Gain: 21 dB
- High OIP3: +24 dBm
- Single Positive Supply: +3V @ 82 mA
- 50 Ohm Matched & DC Blocked I/Os
- 24 Lead 4x4mm QFN Package: 16mm²

Functional Diagram

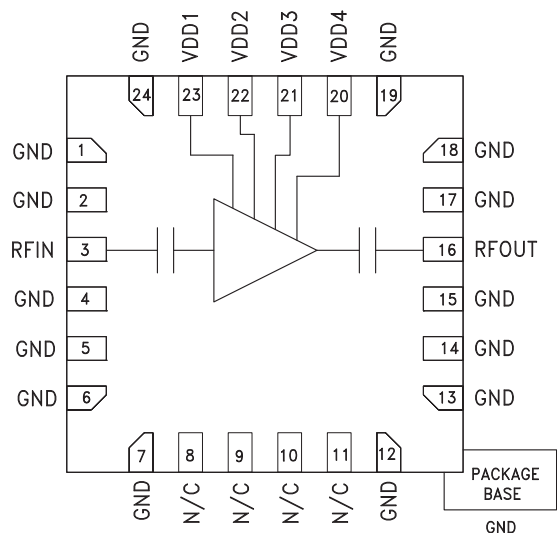

General Description

The HMC566LP4E is a high dynamic range GaAs pHEMT MMIC Low Noise Amplifier (LNA) in a 4x4 mm SMT package which operates from 28 to 36 GHz. The HMC566LP4E provides 21 dB of small signal gain, 2.8 dB of noise figure and output IP3 of 24 dBm. This self-biased LNA is ideal for hybrid and MCM assemblies due to its compact size, single +3V supply operation, and DC blocked RF I/O's. The RoHS packaged HMC566LP4E eliminates the need for wirebonding and allows the use of high volume surface mount manufacturing techniques. The HMC566LP4E is also available in chip form as the HMC566.

Electrical Specifications, $T_A = +25^\circ\text{C}$, $V_{dd\ 1, 2, 3, 4} = +3\text{V}$

Parameter	Min.	Typ.	Max.	Min.	Typ.	Max.	Min.	Typ.	Max.	Units
Frequency Range	28 - 31.5			31.5 - 33.5			33.5 - 36			GHz
Gain	18	21		19.5	22.5		18	21		dB
Gain Variation Over Temperature		0.03			0.03			0.03		dB/ °C
Noise Figure		2.8	3.6		2.8	3.6		3.3	4.3	dB
Input Return Loss		14			18			12		dB
Output Return Loss		8			10			7		dB
Output Power for 1 dB Compression (P1dB)		11			12			11		dBm
Saturated Output Power (P _{sat})		13			14			13		dBm
Output Third Order Intercept (IP3)		23.5			24.5			24.5		dBm
Supply Current (I _{dd1} +I _{dd2} +I _{dd3} +I _{dd4})	50	82	106	50	82	106	50	82	106	mA



GaAs pHEMT MMIC LOW NOISE AMPLIFIER, 28 - 36 GHz

Broadband Gain & Return Loss

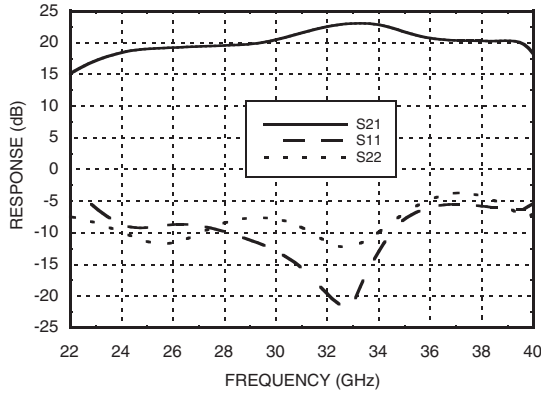

Gain vs. Temperature

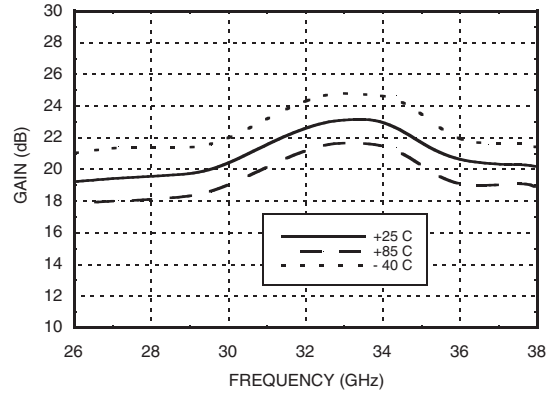

Input Return Loss vs. Temperature

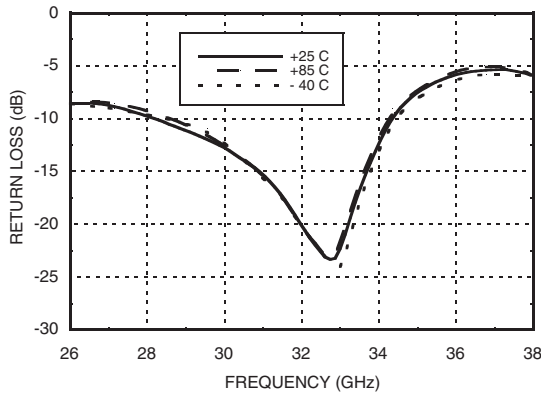

Output Return Loss vs. Temperature

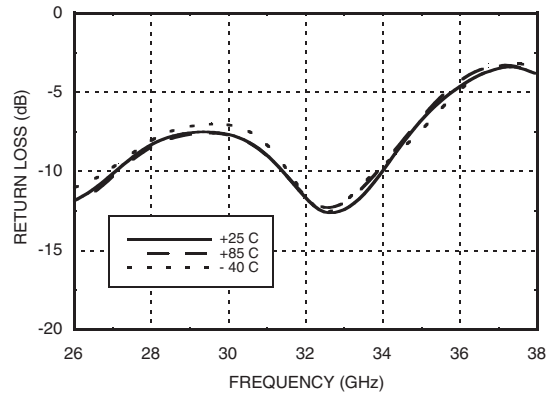

Noise Figure vs. Temperature

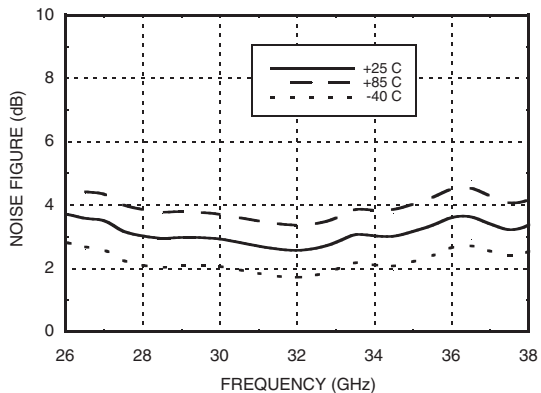

Reverse Isolation vs. Temperature

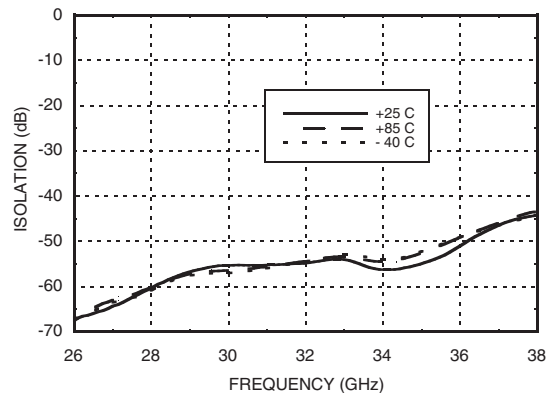

Information furnished by Analog Devices is believed to be accurate and reliable. However, no responsibility is assumed by Analog Devices for its use, nor for any infringements of patents or other rights of third parties that may result from its use. Specifications subject to change without notice. No license is granted by implication or otherwise under any patent or patent rights of Analog Devices. Trademarks and registered trademarks are the property of their respective owners.

For price, delivery, and to place orders: Analog Devices, Inc., One Technology Way, P.O. Box 9106, Norwood, MA 02062-9106 Phone: 781-329-4700 • Order online at www.analog.com Application Support: Phone: 1-800-ANALOG-D



GaAs pHEMT MMIC LOW NOISE AMPLIFIER, 28 - 36 GHz

P1dB vs. Temperature

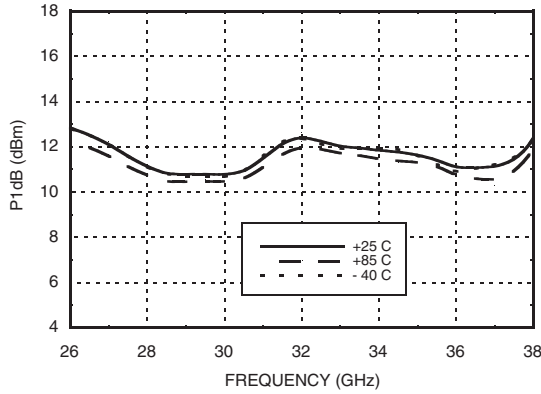

Psat vs. Temperature

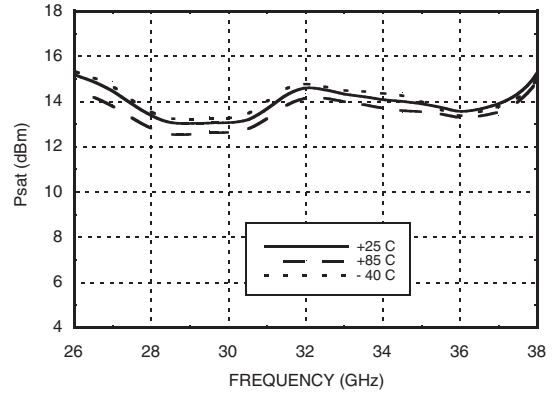

Output IP3 vs. Temperature

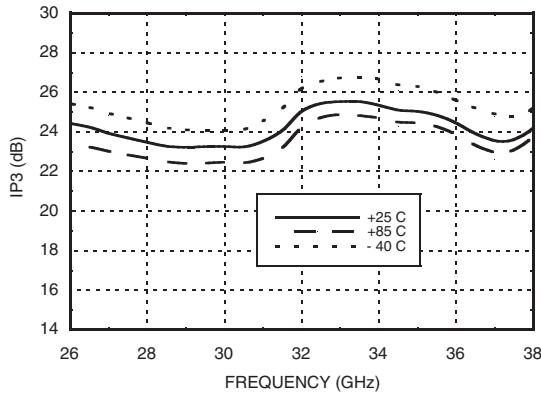

Power Compression @ 32 GHz

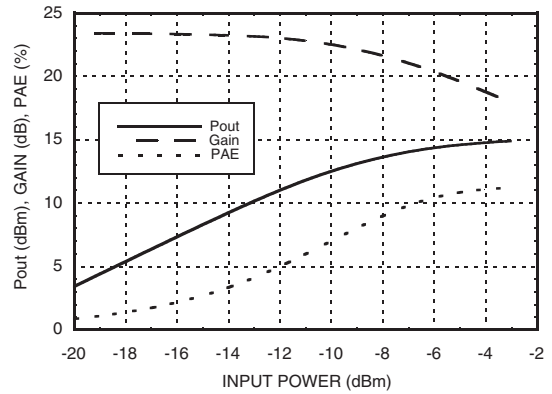

Gain, Noise Figure & Power vs. Supply Voltage @ 32 GHz

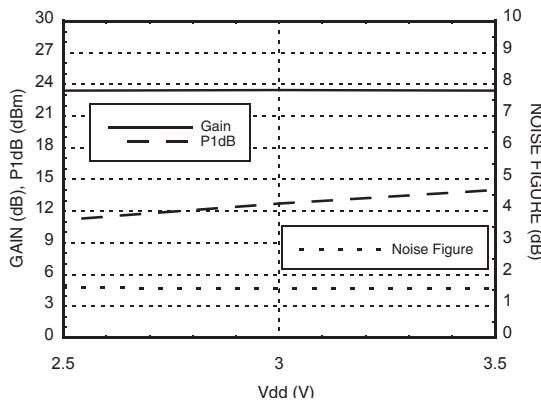

Absolute Maximum Ratings

Drain Bias Voltage (Vdd1, 2, 3, 4)	+3.5 V
RF Input Power (RFIN)(Vdd = +3 Vdc)	+5 dBm
Channel Temperature	175 °C
Continuous P _{diss} (T= 85 °C) (derate 9.6 mW/°C above 85 °C)	0.8 W
Thermal Resistance (channel to ground paddle)	104 °C/W
Storage Temperature	-65 to +150 °C
Operating Temperature	-40 to +85 °C



**ELECTROSTATIC SENSITIVE DEVICE
OBSERVE HANDLING PRECAUTIONS**

Information furnished by Analog Devices is believed to be accurate and reliable. However, no responsibility is assumed by Analog Devices for its use, nor for any infringements of patents or other rights of third parties that may result from its use. Specifications subject to change without notice. No license is granted by implication or otherwise under any patent or patent rights of Analog Devices. Trademarks and registered trademarks are the property of their respective owners.

For price, delivery, and to place orders: Analog Devices, Inc., One Technology Way, P.O. Box 9106, Norwood, MA 02062-9106 Phone: 781-329-4700 • Order online at www.analog.com Application Support: Phone: 1-800-ANALOG-D



Typical Supply Current vs. Vdd

Vdd (V)	Idd (mA)
+2.5	79
+3.0	82
+3.5	85

Note: Amplifier will operate over full voltage ranges shown above.

Pin Descriptions

Pin Number	Function	Description	Interface Schematic
1, 2, 4 - 7, 12 - 15, 17 - 19, 24	GND	This pins and exposed ground paddle must be connected to RF/DC ground.	
3	RFIN	This pin is AC coupled and matched to 50 Ohms.	
8 - 11	N/C	No Connection	
16	RFOUT	This pin is AC coupled and matched to 50 Ohms.	
23, 22, 21, 20	Vdd1, 2, 3, 4	Power Supply Voltage for the amplifier. External bypass capacitors of 100 pF, 10 nF and 4.7 μF are required.	

Application Circuit

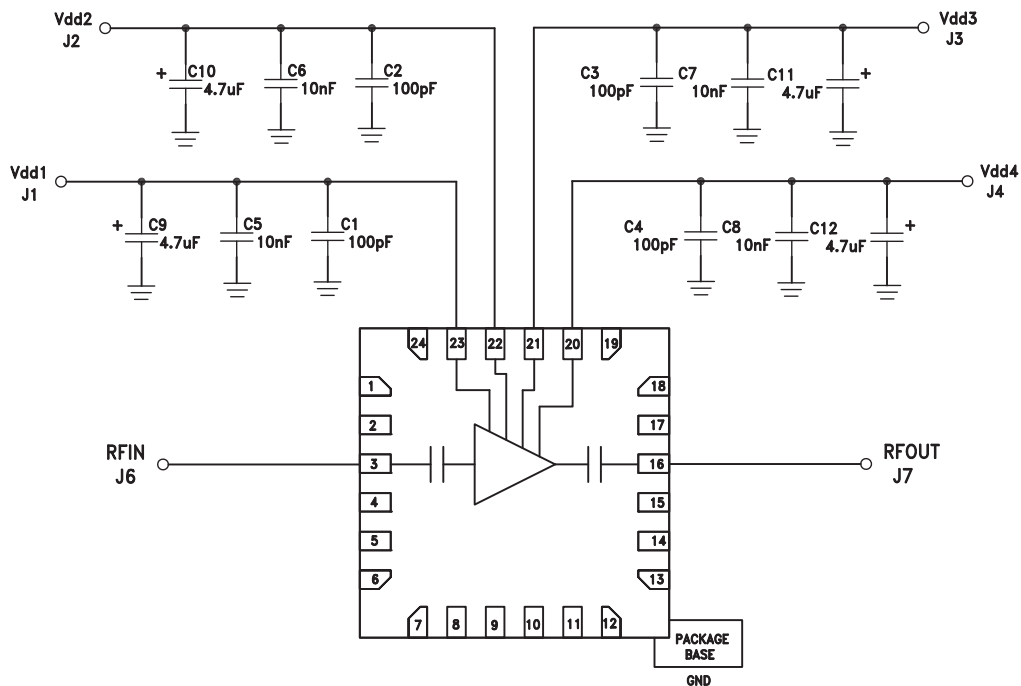

Information furnished by Analog Devices is believed to be accurate and reliable. However, no responsibility is assumed by Analog Devices for its use, nor for any infringements of patents or other rights of third parties that may result from its use. Specifications subject to change without notice. No license is granted by implication or otherwise under any patent or patent rights of Analog Devices. Trademarks and registered trademarks are the property of their respective owners.

For price, delivery, and to place orders: Analog Devices, Inc., One Technology Way, P.O. Box 9106, Norwood, MA 02062-9106 Phone: 781-329-4700 • Order online at www.analog.com Application Support: Phone: 1-800-ANALOG-D

GaAs pHEMT MMIC LOW NOISE AMPLIFIER, 28 - 36 GHz



Outline Drawing

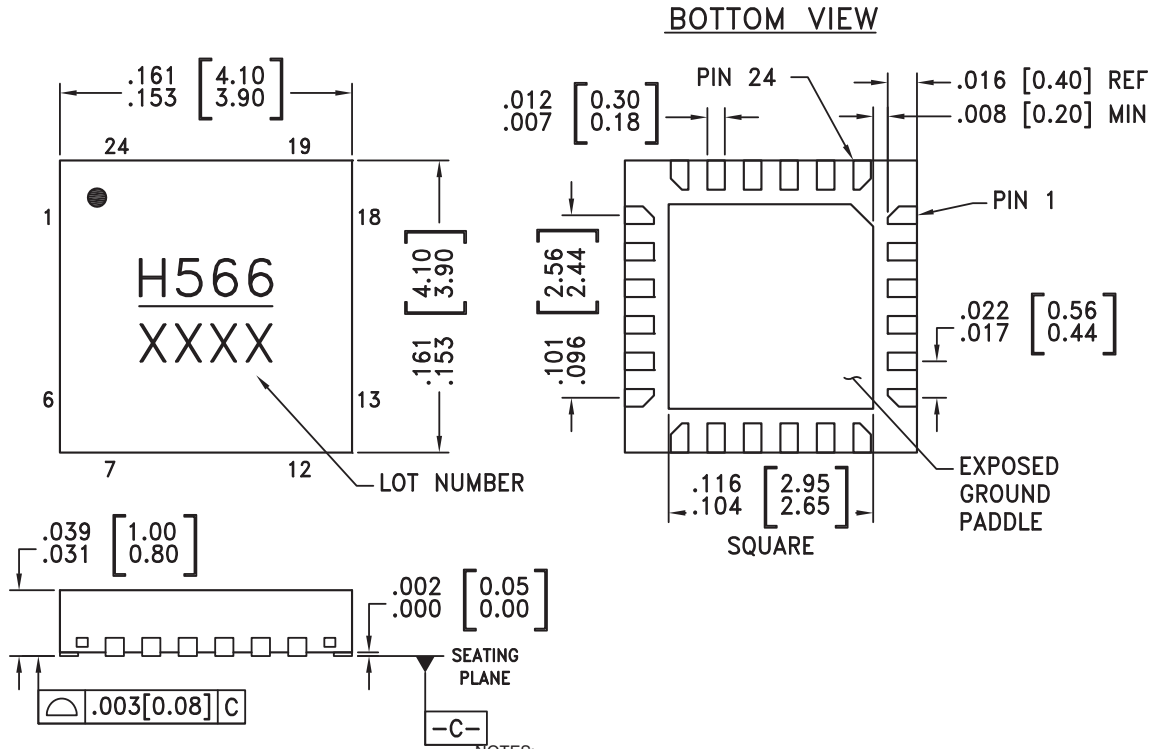

- NOTES:
1. LEADFRAME MATERIAL: COPPER ALLOY
 2. DIMENSIONS ARE IN INCHES [MILLIMETERS]
 3. LEAD SPACING TOLERANCE IS NON-CUMULATIVE
 4. PAD BURR LENGTH SHALL BE 0.15mm MAXIMUM.
PAD BURR HEIGHT SHALL BE 0.05mm MAXIMUM.
 5. PACKAGE WARP SHALL NOT EXCEED 0.05mm.
 6. ALL GROUND LEADS AND GROUND PADDLE MUST BE SOLDERED TO PCB RF GROUND.
 7. REFER TO HITTITE APPLICATION NOTE FOR SUGGESTED LAND PATTERN.

Package Information

Part Number	Package Body Material	Lead Finish	Package Marking ^[1]
HMC566LP4E	RoHS-compliant Low Stress Injection Molded Plastic	100% matte Sn ^[2]	H566 XXXX

[1] 4-Digit lot number XXXX

[2] Max peak reflow temperature of 260 °C



Evaluation PCB

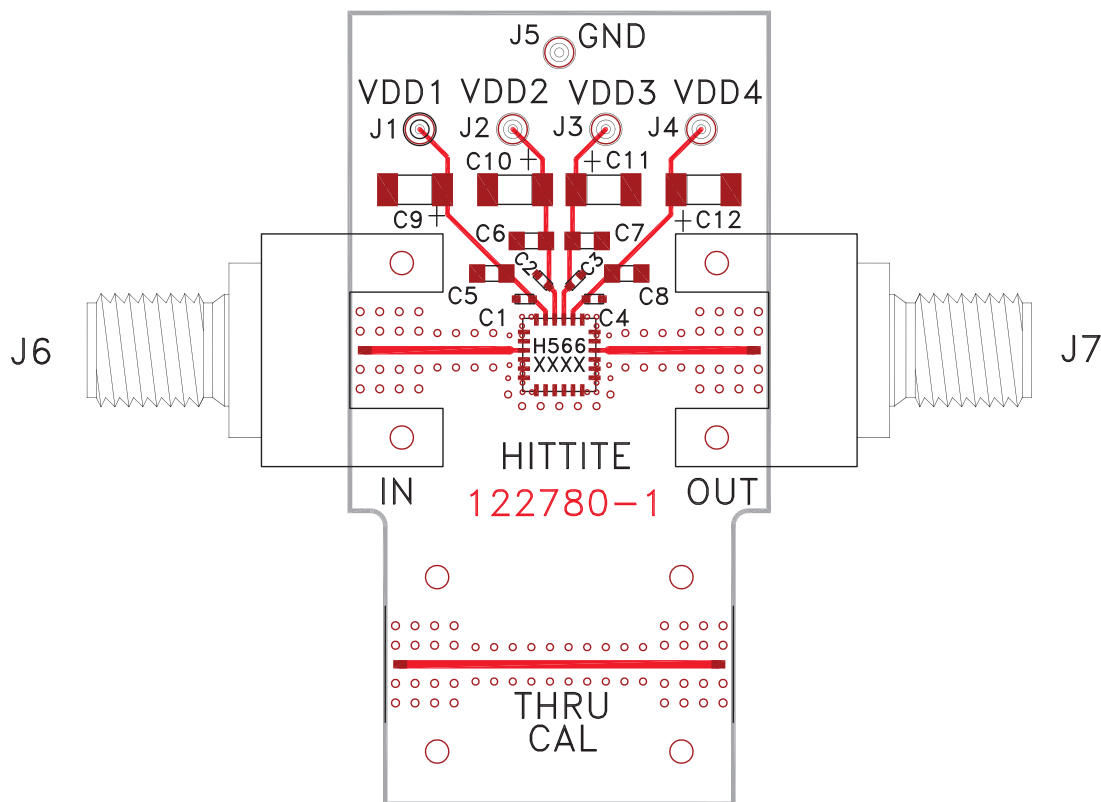

List of Materials for Evaluation PCB 122782 [1]

Item	Description
J1 - J5	DC Pin
J6 - J7	PCB Mount K Connector
C1 - C4	100 pF Capacitor, 0402 Pkg.
C5 - C8	10 nF Capacitor, 0603 Pkg.
C9 - C12	4.7 μF Capacitor, Tantalum
U1	HMC566LP4E
PCB [2]	122780 Evaluation PCB

[1] Reference this number when ordering complete evaluation PCB

[2] Circuit Board Material: Rogers 4350 or Arlon 25 FR

The circuit board used in the application should use RF circuit design techniques. Signal lines should have 50 Ohm impedance while the package ground leads and package bottom should be connected directly to the ground plane similar to that shown. A sufficient number of via holes should be used to connect the top and bottom ground planes. The evaluation board should be mounted to an appropriate heat sink. The evaluation circuit board shown is available from Hittite upon request.

Mouser Electronics

Authorized Distributor

Click to View Pricing, Inventory, Delivery & Lifecycle Information:

[Analog Devices Inc.:](#)

[HMC566LP4E](#) [HMC566LP4ETR](#)