

## GaAs MMIC LOW NOISE AMPLIFIER, 3.5 - 7.0 GHz

### Typical Applications

The HMC392A is ideal for:

- Point-to-Point Radios
- VSAT
- LO Driver for HMC Mixers
- Military EW, ECM, C<sup>3</sup>I
- Space

### Functional Diagram

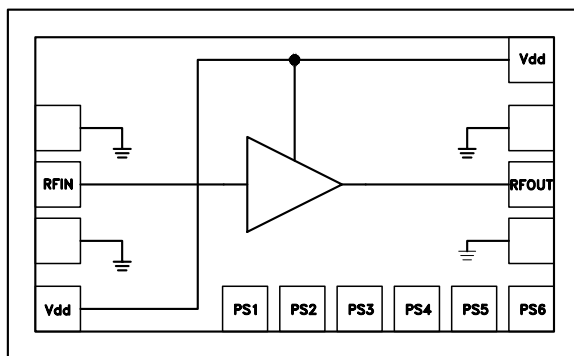

### Features

- Gain: 17.2 dB
- Noise Figure: 1.7 dB
- Single Supply Voltage: +5V
- 50 Ohm Matched Input/Output
- No External Components Required
- Small Size: 1.3 x 1.0 x 0.1 mm

### General Description

The HMC392A is a GaAs MMIC Low Noise Amplifier die which operates between 3.5 and 7.0 GHz. The amplifier provides 17.2 dB of gain, 1.7 dB noise figure, and 32.5 dBm IP3 from a +5V supply voltage. The HMC392A has six bonding adjustment options which allow the user to select the bias point and output power of the device (+10 to +19.7 dBm). The HMC392A amplifier can easily be integrated into Multi-Chip-Modules (MCMs) due to its small (1.3 mm<sup>2</sup>) size. All data is with the chip in a 50 Ohm test fixture connected via 0.025mm (1 mil) diameter wire bonds of minimal length 0.31mm (12 mils).

### Electrical Specifications, $T_A = +25^\circ\text{C}$ , $V_{dd} = 5V$

Parameter	Min.	Typ.	Max.	Min.	Typ.	Max.	Units
Frequency Range	4.0 - 6.0			3.5 - 7.0			GHz
Gain	14.5	17.4		14.5	17.2		dB
Gain Variation Over Temperature		0.005			0.005		dB/ °C
Noise Figure		1.7	3.0		1.7	3.4	dB
Input Return Loss		12			12		dB
Output Return Loss		20			18		dB
Output Power for 1 dB Compression (P1dB)		19.5			19		dBm
Saturated Output Power (Psat)		20.5			20		dBm
Output Third Order Intercept (IP3)		32.5			32.5		dBm
Supply Current (I <sub>dd</sub> )		59	75		59	75	mA

Note: Data taken with pad PS2 bonded to ground (state 2) unless otherwise noted.

**GaAs MMIC LOW NOISE  
AMPLIFIER, 3.5 - 7.0 GHz**

**Broadband Gain & Return Loss**

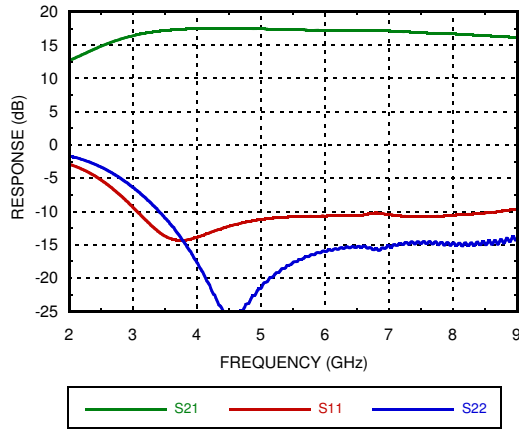

**Gain vs. Temperature**

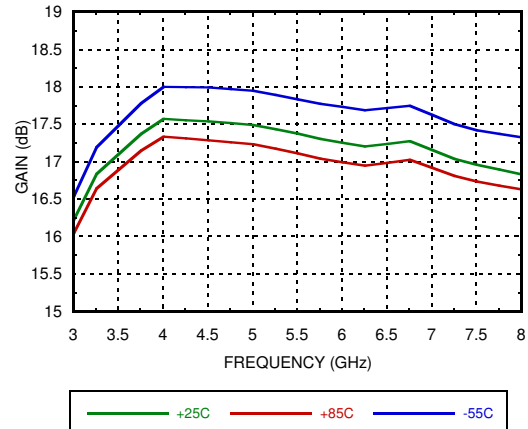

**Input Return Loss vs. Temperature**

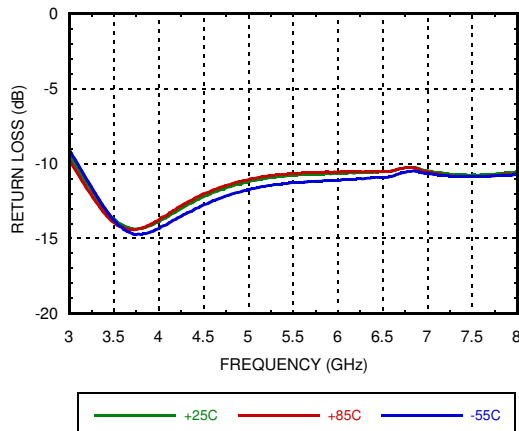

**Output Return Loss vs. Temperature**

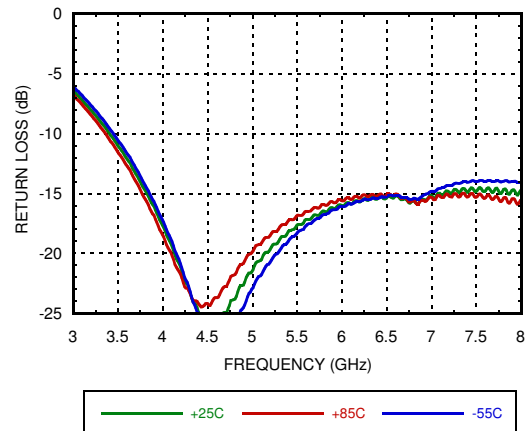

**Noise Figure vs. Temperature**

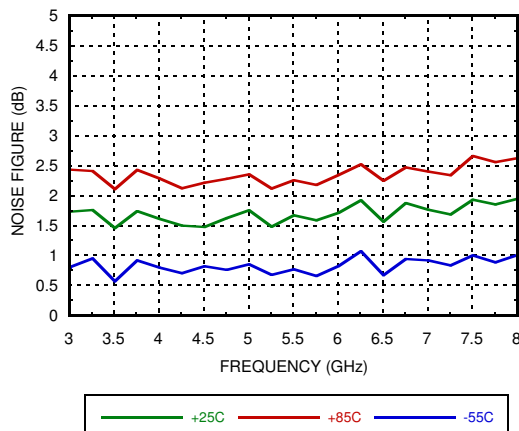

**Reverse Isolation vs. Temperature**

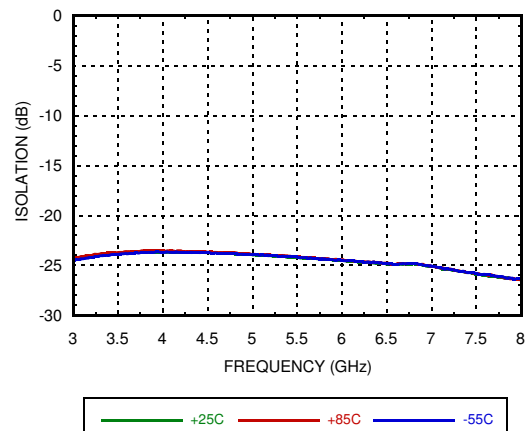

**GaAs MMIC LOW NOISE AMPLIFIER, 3.5 - 7.0 GHz**

**P1dB vs. Temperature**

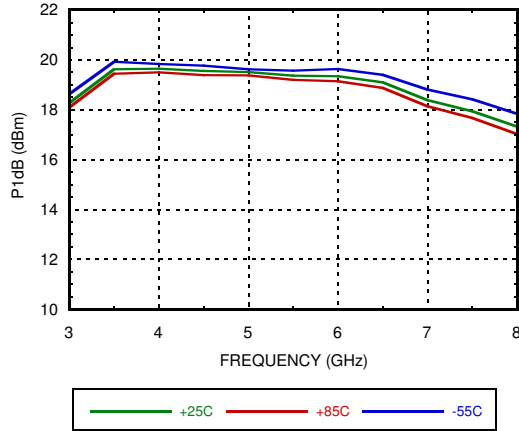

**Psat vs. Temperature**

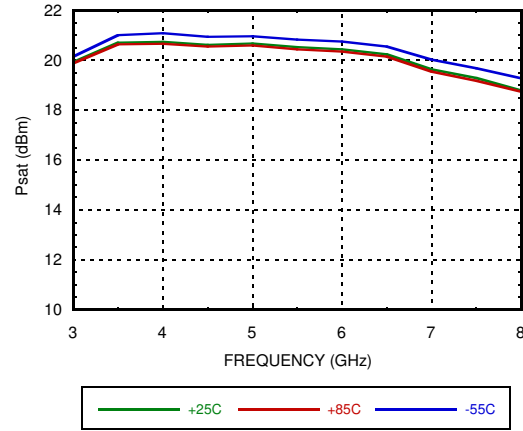

**Output IP3 vs. Temperature**

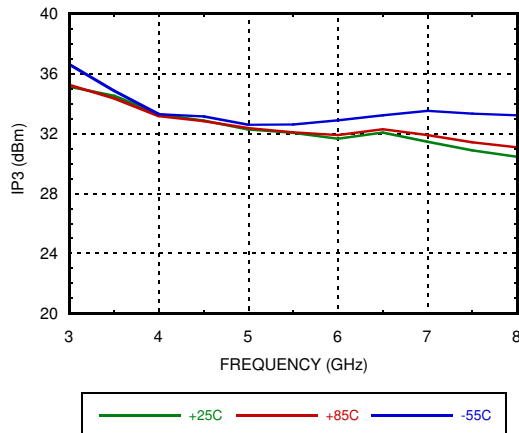

**Gain, Noise Figure & Power vs. Supply Voltage @ 5.5 GHz**

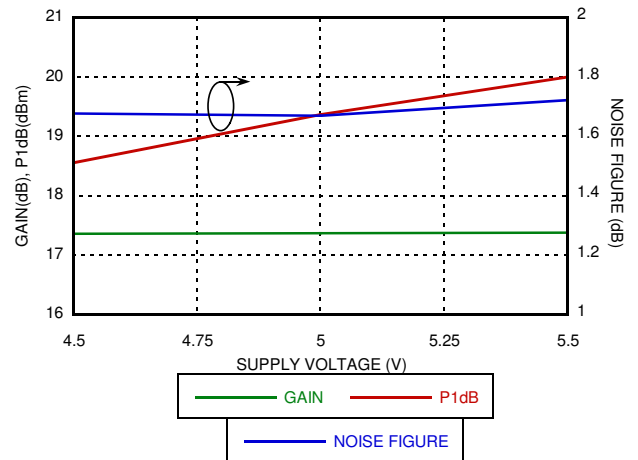

**P1dB vs. Power Select State**

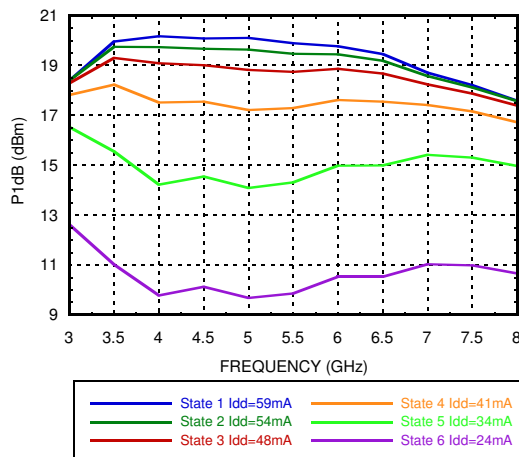

**Gain & Noise Figure vs. Power Select State**

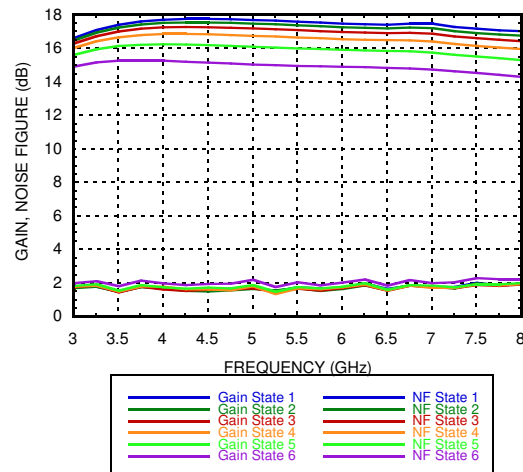

## GaAs MMIC LOW NOISE AMPLIFIER, 3.5 - 7.0 GHz

### Absolute Maximum Ratings

Drain Bias Voltage (Vdd)	+7 Vdc
RF Input Power (RFIN)(Vdd = +5 Vdc)	+20 dBm
Channel Temperature	175 °C
Continuous Pdiss (T= 85 °C) (derate 9.3 mW/°C above 85 °C)	0.83 W
Thermal Resistance (channel to die bottom)	108 °C/W
Storage Temperature	-65 to +150 °C
Operating Temperature	-55 to +85° C
ESD	Class 1A

### Typical Supply Current vs. Vdd

Vdd (Vdc)	Idd (mA)
+4.5	57
+5.0	59
+5.5	62
(State 2 Depicted)	



ELECTROSTATIC SENSITIVE DEVICE  
OBSERVE HANDLING PRECAUTIONS

### Outline Drawing

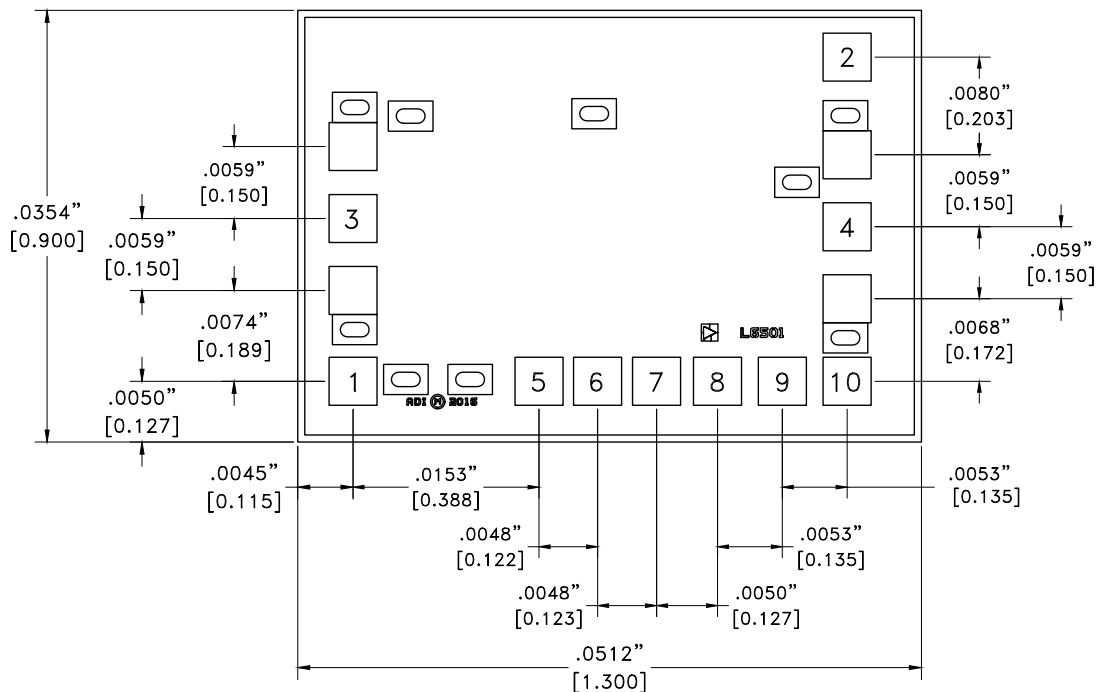

### Die Packaging Information <sup>[1]</sup>

Standard	Alternate
WP-16 (Waffle Pack)	[2]

[1] Refer to the "Packaging Information" section for die packaging dimensions.

[2] For alternate packaging information contact Hittite Microwave Corporation.

#### NOTES:

1. ALL DIMENSIONS IN INCHES [MILLIMETERS]
2. ALL TOLERANCES ARE  $\pm 0.001$  (0.025)
3. DIE THICKNESS IS 0.004 (0.100) BACKSIDE IS GROUND
4. BOND PADS ARE 0.004 (0.100) SQUARE
5. BOND PAD SPACING, CTR-CTR: 0.006 (0.150)
6. BACKSIDE METALLIZATION: GOLD
7. BOND PAD METALLIZATION: GOLD

## GaAs MMIC LOW NOISE AMPLIFIER, 3.5 - 7.0 GHz

### Pad Descriptions

Pad Number	Function	Description	Interface Schematic
3	RFIN	This pad is AC coupled and matched to 50 Ohms	
5 6 7 8 9 10	Power Select PS1 PS2 PS3 PS4 PS5 PS6	One of these pads must be connected to ground. See Power Select Table for selection criteria.	
1, 2	Vdd, Vdd (alt.)	Power supply voltage. Connect either pad 1 or pad 2 to +5V supply. No choke inductor or bypass capacitor is needed.	
4	RFOUT	This pad is AC coupled and matched to 50 Ohms	
Die Bottom	GND	Die bottom must be connected to RF/DC ground.	

### Power Select Table

State	Pads Bonded to Ground	Typical I <sub>dd</sub> (mA)	Typical P <sub>1dB</sub> (dBm)
1	PS1	69	19.7
2	PS2	59	19.4
3	PS3	49	18.8
4	PS4	38	17.5
5	PS5	27	14.8
6	PS6	17	10.3

## GaAs MMIC LOW NOISE AMPLIFIER, 3.5 - 7.0 GHz

### Assembly Diagram

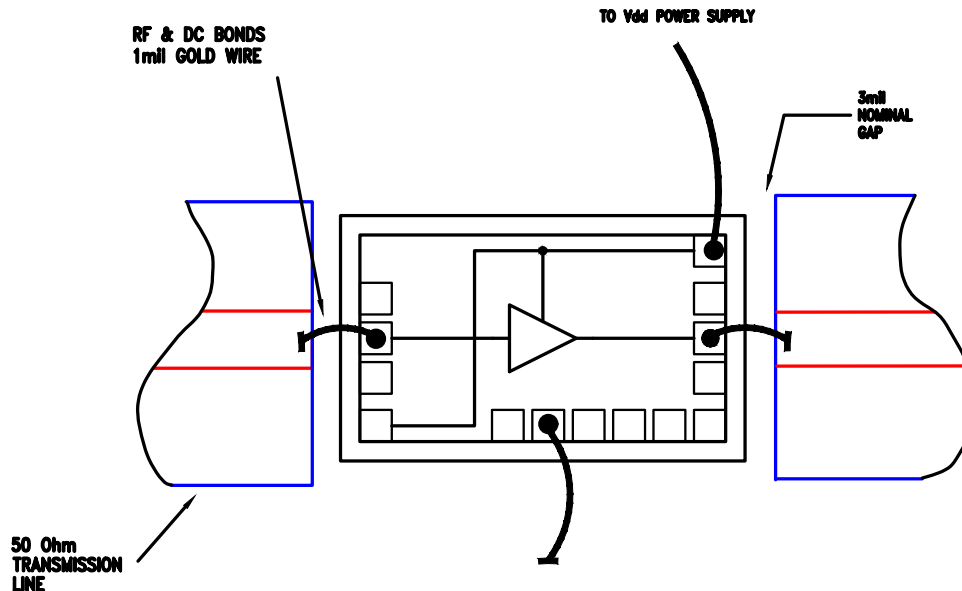

Note: State 2 shown. PS2 bonded to ground.

### Handling Precautions

Follow these precautions to avoid permanent damage.

**Storage:** All bare die are placed in either Waffle or Gel based ESD protective containers, and then sealed in an ESD protective bag for shipment. Once the sealed ESD protective bag has been opened, all die should be stored in a dry nitrogen environment.

**Cleanliness:** Handle the chips in a clean environment. DO NOT attempt to clean the chip using liquid cleaning systems.

**Static Sensitivity:** Follow ESD precautions to protect against ESD strikes.

**Transients:** Suppress instrument and bias supply transients while bias is applied. Use shielded signal and bias cables to minimize inductive pick-up.

**General Handling:** Handle the chip along the edges with a vacuum collet or with a sharp pair of bent tweezers. The surface of the chip has fragile air bridges and should not be touched with vacuum collet, tweezers, or fingers.

### Mounting

The chip is back-metallized and can be die mounted with AuSn eutectic preforms or with electrically conductive epoxy. The mounting surface should be clean and flat.

**Eutectic Die Attach:** A 80/20 gold tin preform is recommended with a work surface temperature of 255 °C and a tool temperature of 265 °C. When hot 90/10 nitrogen/hydrogen gas is applied, tool tip temperature should be 290 °C. DO NOT expose the chip to a temperature greater than 320 °C for more than 20 seconds. No more than 3 seconds of scrubbing should be required for attachment.

**Epoxy Die Attach:** Apply a minimum amount of epoxy to the mounting surface so that a thin epoxy fillet is observed around the perimeter of the chip once it is placed into position. Cure epoxy per the manufacturer's schedule.

### Wire Bonding

Ball or wedge bond with 0.025mm (1 mil) diameter pure gold wire. Thermosonic wirebonding with a nominal stage temperature of 150 °C and a ball bonding force of 40 to 50 grams or wedge bonding force of 18 to 22 grams is recommended. Use the minimum level of ultrasonic energy to achieve reliable wirebonds. Wirebonds should be started on the chip and terminated on the package or substrate. All bonds should be as short as possible <0.31mm (12 mils).

# Mouser Electronics

Authorized Distributor

Click to View Pricing, Inventory, Delivery & Lifecycle Information:

[Analog Devices Inc.:](#)

[HMC392A](#) [HMC392A-SX](#)