

LT8337-1

28V, 5A Low I_Q Synchronous Step-Up Silent Switcher with PassThru and V_C Pin

DESCRIPTION

Evaluation circuit EVAL-LT8337-1-AZ features the [LT[®]8337-1](#) as a 2MHz low I_Q , synchronous boost converter with a 12V output from 4.5V to 12V input. When V_{IN} goes above the 12V output regulation setpoint, the LT8337-1 smoothly transitions between regulation and PassThru™ mode. This evaluation circuit features Spread Spectrum Frequency Modulation (SSFM), Silent Switcher[®] technology, and EMI filters to provide optimum EMI performance. The converter can output 1.2A or more depending on input voltage (see Figure 3 for the Maximum Output Current vs V_{IN} curve). When placed in shutdown, the converter has very low quiescent current, ideal in automotive and other battery-powered applications. PULSE SKIP and BURST modes are selectable with jumper JP1. Each user-selectable option enables low quiescent current at light load and can also be combined with SSFM operation using JP1.

The LT8337-1 boost converter IC operates over an input range of 2.7V to 28V, suitable for automotive, telecom and industrial applications. It exhibits a low quiescent current

of 23 μ A, making it ideal for battery-operated systems. The converter provides adjustable and synchronizable operation from 300kHz to 3MHz with SSFM option. At light load, either PULSE SKIP or low-ripple BURST mode can be selected to improve the efficiency. The LT8337-1 packs popular features such as soft-start, input under-voltage lockout, adjustable switching frequency and clock synchronization. The V_C pin grants easy accessibility to change loop compensation to complement most applications.

The LT8337-1 comes in a small 16-lead plastic LQFN package for optimal size and emissions. The LT8337-1 data sheet gives a complete description of the part, pins, features, operation, and application information. The data sheet must be read in conjunction with this demo manual for EVAL-LT8337-1-AZ.

[Design files for this circuit board are available.](#)

All registered trademarks and trademarks are the property of their respective owners.

DEMO MANUAL

EVAL-LT8337-1-AZ

PERFORMANCE SUMMARY Specifications are at $T_A = 25^\circ\text{C}$

PARAMETER	CONDITIONS	MIN	TYP	MAX	UNITS
Input Voltage (V_{IN})	12V _{OUT}	4	5, 9	12	V
Output Voltage (V_{OUT})	R1 = 1M Ω , R2 = 90.9k Ω		12		V
Input Voltage (V_{IN}) in PassThru	$V_{OUT} = V_{IN}$	12		20	V
Maximum Output Current	12V _{OUT} , 5V _{IN}		1.35		A
	12V _{OUT} , 9V _{IN}		2.5		A
Switching Frequency	R6 = 47.5k Ω , SSFM OFF		2		MHz
	R6 = 47.5k Ω , SSFM ON	2		2.4	MHz
Input EN Voltage (Rising)	R3 = 1M Ω , R4 = 330k Ω		4.3		V
Input UVLO Voltage (Falling)	R3 = 1M Ω , R4 = 330k Ω		4.0		V
Typical Efficiency (with EMI Filters)	9V _{IN} , 12V 2.5A Output, JP1 = BURST		94		%
	5V _{IN} , 12V 1.35A Output, JP1 = BURST		92		%
Zero Load Quiescent Current (12V _{OUT})* R3 = 1M Ω , R4 = 330k Ω R1 = 1M Ω , R2 = 90.9k Ω	5V _{IN} , JP1 = PULSE SKIP		45		mA
	5V _{IN} , JP1 = BURST		70		μA
	9V _{IN} , JP1 = PULSE SKIP		1.1		mA
	9V _{IN} , JP1 = BURST		57		μA

*Please see PULSE SKIP, BURST, SSFM, SYNC section on how to achieve lower quiescent current.

QUICK START PROCEDURE

Evaluation circuit EVAL-LT8337-1-AZ is easy to set up to evaluate the performance of the LT8337-1. Refer to Figure 1 for proper measurement equipment setup and follow the procedure below:

1. Connect EN/UVLO turret to GND.
2. With power off, connect the input power supply to the board through V_{IN} and GND terminals. Connect the load to the terminals V_{OUT} and GND.
3. Turn on the power at the input. Increase V_{IN} slowly to 5V.

NOTE: Make sure that the input voltage is always within spec. To operate the board with higher input/output voltage, input and output capacitors with higher voltage ratings might be needed.

4. Disconnect EN/UVLO from GND and the output turns on.

5. Check for the proper output voltage. The output should be regulated at 12V.
6. Once the proper output voltage is established, adjust the input voltage and load current within the operating range and observe the output voltage regulation, ripple voltage, efficiency, and other parameters.
7. Set JP1 to examine the low I_Q , light load operation of the LT8337-1. SSFM can be turned on and off with this jumper position as well.

NOTE: When measuring the input or output voltage ripple, care must be taken to avoid a long ground lead on the oscilloscope probe. Measure the input or output voltage ripple by touching the probe tip directly across the input and output capacitors.

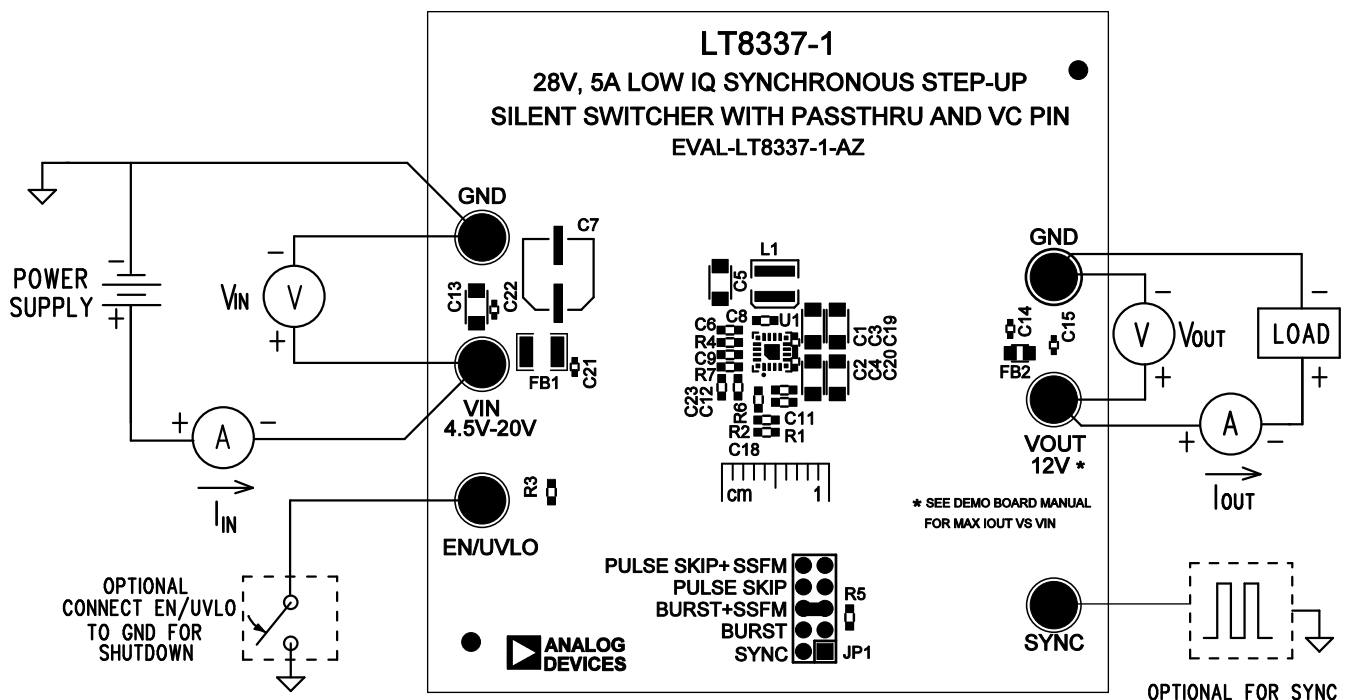

Figure 1. Test Procedure Setup Drawing for EVAL-LT8337-1-AZ

QUICK START PROCEDURE

Output Voltage and Power

The LT8337-1 is a low I_Q synchronous boost converter. It can boost voltages up to 28V with internal synchronous MOSFETs. The feedback resistors and output capacitor must be sized appropriately for the output voltage. Although EVAL-LT8337-1-AZ is set for 12V output, the feedback resistors R1 and R2 can be easily adjusted for higher or lower output voltage. In addition to adjusting feedback resistors, the input and output capacitors should be sized appropriately.

Figure 3 shows the Maximum Output Current vs V_{IN} . The peak switch current limit is 5A, limiting the amount of output current in this boost converter to just above 1.2A at $4.5V_{IN}$. However, at $5V_{IN}$, 1.35A is possible. At $9V_{IN}$, over 2.5A is possible.

PULSE SKIP, BURST, SSFM, SYNC

The LT8337-1 achieves low power consumption at light loads. The different SYNC/MODE pin states can be evaluated by changing the position of jumper JP1. It is easy to change from BURST to PULSE SKIP and to explore SSFM ON, SSFM OFF, and external SYNC with this jumper.

PULSE SKIP allows low quiescent current at light load consumption without changing switching frequency until a very light load. BURST allows the lowest light load power consumption and has a unique low ripple feature on the LT8337-1. These two features can be explored further in the data sheet of the LT8337-1. For extremely light load power consumption on EVAL-LT8337-1-AZ, the feedback resistor R1 should be changed to a 10M resistor, and R2 to a 909k resistor. Also, the EN/UVLO pin should be shorted to V_{IN} and the R4 330k resistor should be removed. Then the quiescent current of the converter can drop as low as 23 μ A.

Spread Spectrum Frequency Modulation (SSFM) can be enabled to reduce the emissions of the converter. SSFM spreads the frequency between the R_T frequency and +20% higher.

If an external SYNC signal is provided, the SYNC option of JP1 can be used to synchronize with an external clock. The clock frequency should be slightly higher than the R_T programmed frequency for best performance.

EN/UVLO

R3 and R4 set the undervoltage lockout falling and rising thresholds. The LT8337-1 data sheet gives a formula for calculating these values. EVAL-LT8337-1-AZ has a falling UVLO threshold of 4.0V and a rising threshold of 4.3V. This threshold can easily be adjusted by changing resistors R3 and R4 according to the data sheet equations.

PassThru

For boost pre-regulator applications such as automotive stop-start and cold crank, where V_{IN} is normally greater than the V_{OUT} regulation, the LT8337-1 features PassThru technology. The IC is designed to have accurate and well controlled PassThru operation. In PassThru mode, the IC keeps the top switch on, essentially shorting V_{IN} to V_{OUT} . If V_{IN} falls below the V_{OUT} regulation setpoint, the IC acts like a normal boost converter and commences switching to maintain V_{OUT} at the regulation setpoint. Figure 5 illustrates PassThru mode. See the data sheet for details.

TEST RESULTS

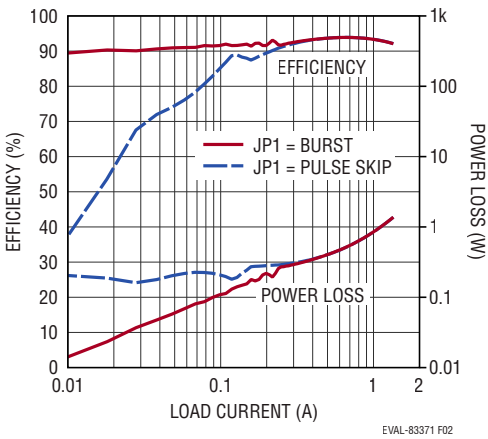

Figure 2. EVAL-LT8337-1-AZ Efficiency and Power Loss vs Load with $V_{IN} = 5V$ to $V_{OUT} = 12V$

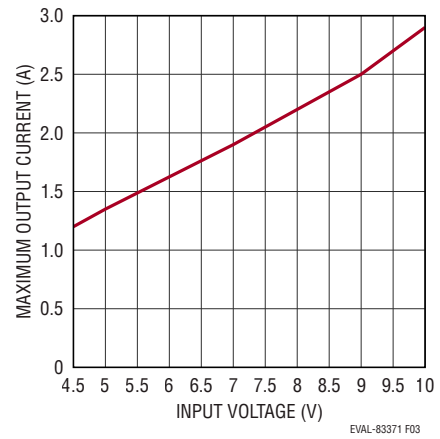

Figure 3. EVAL-LT8337-1-AZ Maximum Output Current vs Input Voltage

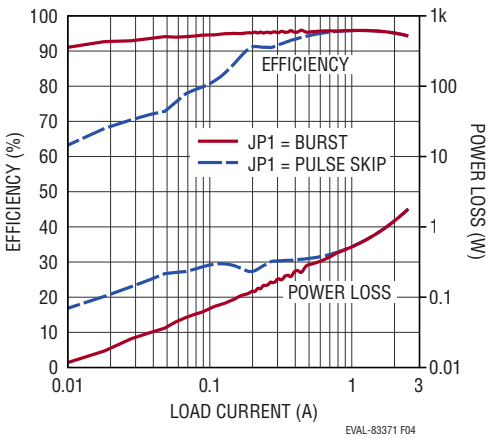

Figure 4. EVAL-LT8337-1-AZ Efficiency and Power Loss vs Load with $V_{IN} = 9V$ to $V_{OUT} = 12V$

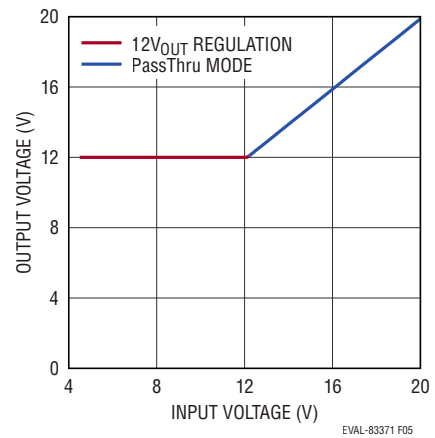

Figure 5. EVAL-LT8337-1-AZ Output Voltage vs Input Voltage with Regulation and PassThru Mode

TEST RESULTS

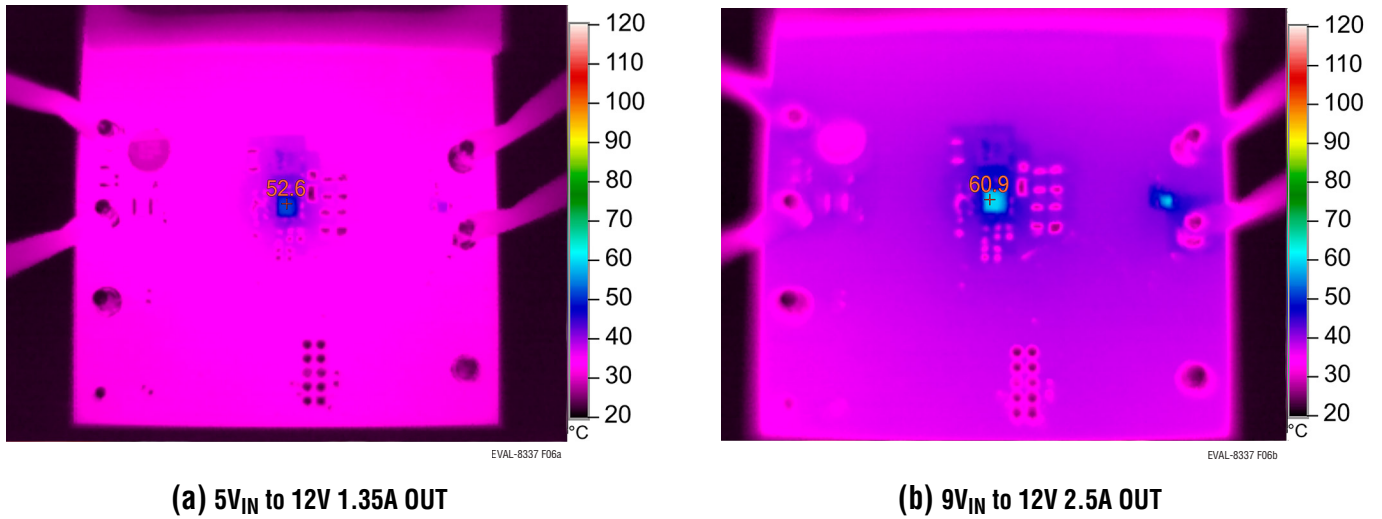

Figure 6. EVAL-LT8337-1-AZ Thermals

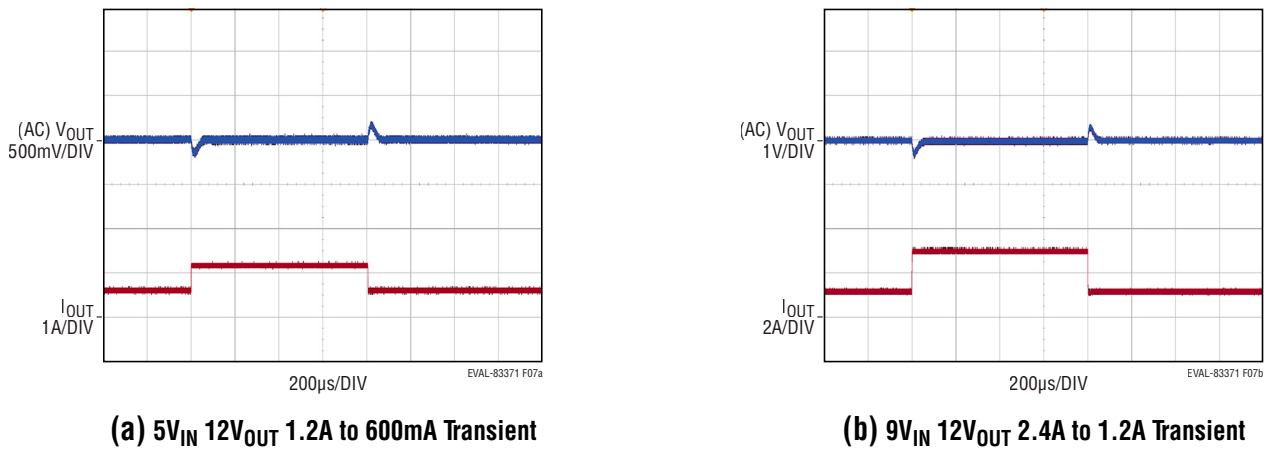

Figure 7. EVAL-LT8337-1-AZ V_{OUT} Transient Response with JP1 = PULSE SKIP

TEST RESULTS

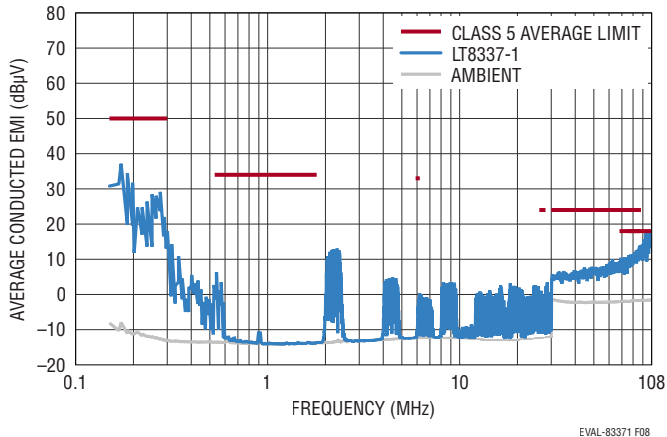

Figure 8. EVAL-LT8337-1-AZ CISPR25 Voltage CE Average Performance with 5V_{IN} to 12V_{OUT} at 1.2A, JP1 = BURST+SSFM

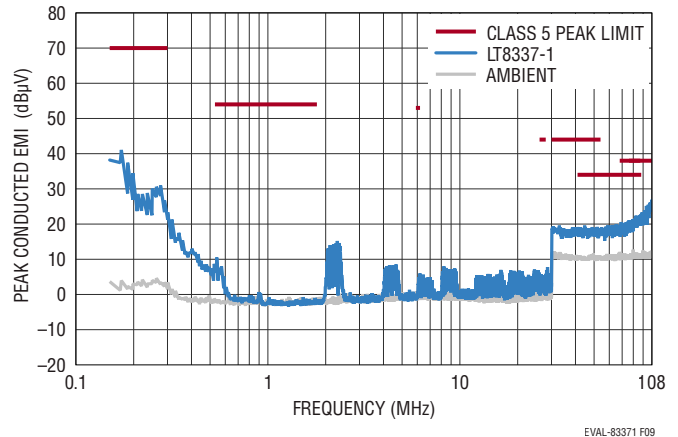

Figure 9. EVAL-LT8337-1-AZ CISPR25 Voltage CE Peak Performance with 5V_{IN} to 12V_{OUT} at 1.2A, JP1 = BURST+SSFM

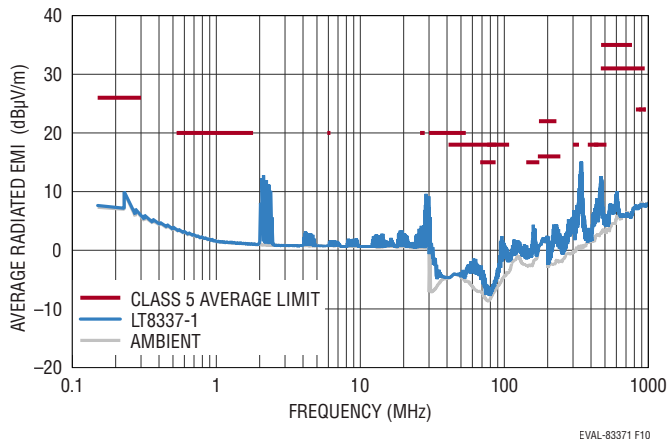

Figure 10. EVAL-LT8337-1-AZ CISPR25 RE Average Performance with 5V_{IN} to 12V_{OUT} at 1.2A, JP1 = BURST+SSFM

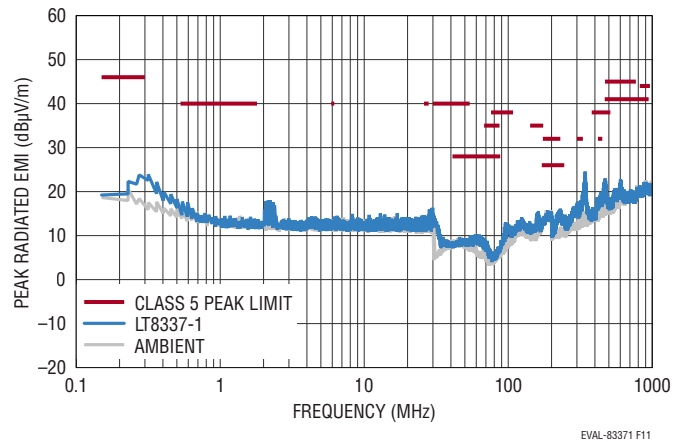

Figure 11. EVAL-LT8337-1-AZ CISPR25 RE Peak Performance with 5V_{IN} to 12V_{OUT} at 1.2A, JP1 = BURST+SSFM

DEMO MANUAL

EVAL-LT8337-1-AZ

PARTS LIST

ITEM	QTY	REFERENCE	PART DESCRIPTION	MANUFACTURER/PART NUMBER
Required Electrical Components				
1	2	C1, C2	CAP, 1 μ F, X5R, 25V, 10%, 0402, AEC-Q200	MURATA, GRT155R61E105KE01D
2	4	C3, C4, C19, C20	CAP, 22 μ F, X5R, 25V, 10%, 1206	MURATA, GRM31CR61E226KE15L
3	2	C5, C13	CAP, 10 μ F, X7R, 25V, 10%, 1206, AEC-Q200	KEMET, C1206C106K3RACAUTO
4	2	C6, C9	CAP, 1 μ F, X7R, 25V, 10%, 0603, AEC-Q200	MURATA, GCM188R71E105KA64D
5	1	C8	CAP, 0.1 μ F, X7R, 50V, 10%, 0603	MURATA, GRM188R71H104KA93D
6	1	C11	CAP, 4.7pF, C0G/NP0, 50V, \pm 0.25pF, 0603	MURATA, GRM1885C1H4R7CA01D
7	1	C23	CAP, 680pF, C0G, 25V, 5%, 0603	AVX, 06033A681JAT2A
8	1	L1	IND., 1.5 μ H, PWR, 20%, 6.2A, 20m Ω , SMD, AEC-Q200	WURTH ELEKTRONIK, 74438357015
9	2	R1, R3	RES., 1M, 1%, 1/10W, 0603, AEC-Q200	VISHAY, CRCW06031M00FKEA
10	1	R2	RES., 90.9k, 1%, 1/10W, 0603, AEC-Q200	VISHAY, CRCW060390K9FKEA
11	1	R4	RES., 330k, 1%, 1/10W, 0603, AEC-Q200	VISHAY, CRCW0603330KFKEA
12	1	R6	RES., 47.5k, 1%, 1/10W, 0603	VISHAY, CRCW060349K9FKEA
13	1	R7	RES., 20k, 1%, 1/10W, 0603	VISHAY, CRCW060320K0FKEA
14	1	U1	IC, , LOW IQ SYNC STEP-UP Silent Switcher, LQFN-16	ANALOG DEVICES, LT8337JV-1#PBF
Optional Electrical Components				
1	1	C7	CAP, 68 μ F, ALUM POLY HYB, 25V, 20%, 6.3mm x 5.8mm, SMD, RADIAL, AEC-Q200	PANASONIC, EEHZK1E680P
2	0	C12, C18	CAP, OPTION, 0603	
3	2	C14, C15	CAP, 0.1 μ F, X7R, 50V, 10%, 0402, AEC-Q200	MURATA, GCM155R71H104KE02D
4	2	C21, C22	CAP, 0.1 μ F, X7R, 25V, 10%, 0402, AEC-Q200	MURATA, GCM155R71E104KE02D
5	1	FB1	IND., 0.25 μ H, PWR, 30%, 5.5A, 0.12.5m Ω , 1210	WURTH ELEKTRONIK, 74479290125
6	1	FB2	IND., 600 Ω AT 100MHz, FERRITE BEAD, 25%, 2A, 150m Ω , 0805	WURTH ELEKTRONIK, 742792040
7	1	R5	RES., 49.9k, 1%, 1/10W, 0603	VISHAY, CRCW060349K9FKEA
Hardware				
1	7	E1, E2, E3, E4, E5, E6, E7	TEST POINT, TURRET, 0.094" MTG. HOLE, PCB 0.062 THK	MILL-MAX, 2501-2-00-80-00-00-07-0
2	1	JP1	CONN., HDR, MALE, 2x5, 2mm, VERT, ST, THT	WURTH ELEKTRONIK, 62001021121
3	1	XJP1	CONN., SHUNT, FEMALE, 2-POS, 2mm	WURTH ELEKTRONIK, 60800213421

SCHEMATIC DIAGRAM

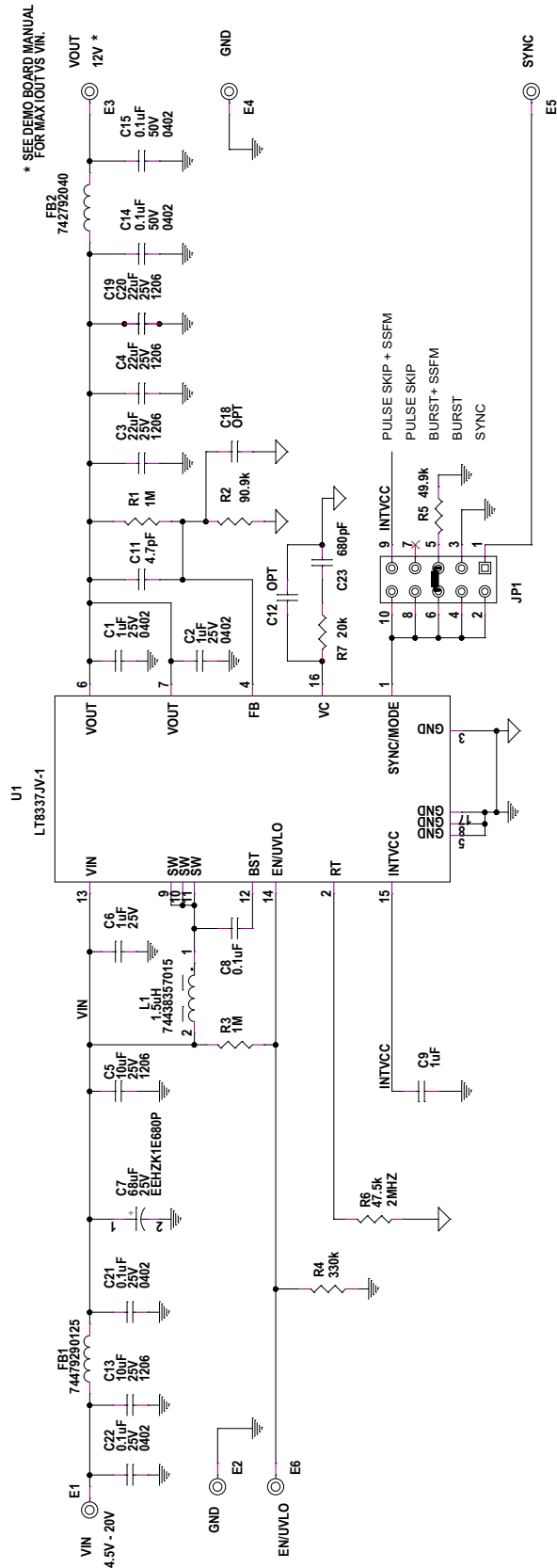



ESD Caution

ESD (electrostatic discharge) sensitive device. Charged devices and circuit boards can discharge without detection. Although this product features patented or proprietary protection circuitry, damage may occur on devices subjected to high energy ESD. Therefore, proper ESD precautions should be taken to avoid performance degradation or loss of functionality.

Legal Terms and Conditions

By using the evaluation board discussed herein (together with any tools, components documentation or support materials, the "Evaluation Board"), you are agreeing to be bound by the terms and conditions set forth below ("Agreement") unless you have purchased the Evaluation Board, in which case the Analog Devices Standard Terms and Conditions of Sale shall govern. Do not use the Evaluation Board until you have read and agreed to the Agreement. Your use of the Evaluation Board shall signify your acceptance of the Agreement. This Agreement is made by and between you ("Customer") and Analog Devices, Inc. ("ADI"), with its principal place of business at One Technology Way, Norwood, MA 02062, USA. Subject to the terms and conditions of the Agreement, ADI hereby grants to Customer a free, limited, personal, temporary, non-exclusive, non-sublicensable, non-transferable license to use the Evaluation Board FOR EVALUATION PURPOSES ONLY. Customer understands and agrees that the Evaluation Board is provided for the sole and exclusive purpose referenced above, and agrees not to use the Evaluation Board for any other purpose. Furthermore, the license granted is expressly made subject to the following additional limitations: Customer shall not (i) rent, lease, display, sell, transfer, assign, sublicense, or distribute the Evaluation Board; and (ii) permit any Third Party to access the Evaluation Board. As used herein, the term "Third Party" includes any entity other than ADI, Customer, their employees, affiliates and in-house consultants. The Evaluation Board is NOT sold to Customer; all rights not expressly granted herein, including ownership of the Evaluation Board, are reserved by ADI. CONFIDENTIALITY. This Agreement and the Evaluation Board shall all be considered the confidential and proprietary information of ADI. Customer may not disclose or transfer any portion of the Evaluation Board to any other party for any reason. Upon discontinuation of use of the Evaluation Board or termination of this Agreement, Customer agrees to promptly return the Evaluation Board to ADI. ADDITIONAL RESTRICTIONS. Customer may not disassemble, decompile or reverse engineer chips on the Evaluation Board. Customer shall inform ADI of any occurred damages or any modifications or alterations it makes to the Evaluation Board, including but not limited to soldering or any other activity that affects the material content of the Evaluation Board. Modifications to the Evaluation Board must comply with applicable law, including but not limited to the RoHS Directive. TERMINATION. ADI may terminate this Agreement at any time upon giving written notice to Customer. Customer agrees to return to ADI the Evaluation Board at that time. LIMITATION OF LIABILITY. THE EVALUATION BOARD PROVIDED HEREUNDER IS PROVIDED "AS IS" AND ADI MAKES NO WARRANTIES OR REPRESENTATIONS OF ANY KIND WITH RESPECT TO IT. ADI SPECIFICALLY DISCLAIMS ANY REPRESENTATIONS, ENDORSEMENTS, GUARANTEES, OR WARRANTIES, EXPRESS OR IMPLIED, RELATED TO THE EVALUATION BOARD INCLUDING, BUT NOT LIMITED TO, THE IMPLIED WARRANTY OF MERCHANTABILITY, TITLE, FITNESS FOR A PARTICULAR PURPOSE OR NON-INFRINGEMENT OF INTELLECTUAL PROPERTY RIGHTS. IN NO EVENT WILL ADI AND ITS LICENSORS BE LIABLE FOR ANY INCIDENTAL, SPECIAL, INDIRECT, OR CONSEQUENTIAL DAMAGES RESULTING FROM CUSTOMER'S POSSESSION OR USE OF THE EVALUATION BOARD, INCLUDING BUT NOT LIMITED TO LOST PROFITS, DELAY COSTS, LABOR COSTS OR LOSS OF GOODWILL. ADI'S TOTAL LIABILITY FROM ANY AND ALL CAUSES SHALL BE LIMITED TO THE AMOUNT OF ONE HUNDRED US DOLLARS (\$100.00). EXPORT. Customer agrees that it will not directly or indirectly export the Evaluation Board to another country, and that it will comply with all applicable United States federal laws and regulations relating to exports. GOVERNING LAW. This Agreement shall be governed by and construed in accordance with the substantive laws of the Commonwealth of Massachusetts (excluding conflict of law rules). Any legal action regarding this Agreement will be heard in the state or federal courts having jurisdiction in Suffolk County, Massachusetts, and Customer hereby submits to the personal jurisdiction and venue of such courts. The United Nations Convention on Contracts for the International Sale of Goods shall not apply to this Agreement and is expressly disclaimed.

Mouser Electronics

Authorized Distributor

Click to View Pricing, Inventory, Delivery & Lifecycle Information:

[Analog Devices Inc.:](#)

[EVAL-LT8337-1-AZ](#)