

GaAs, pHEMT, MMIC, Low Noise Amplifier, 1 GHz to 22 GHz
FEATURES

- ▶ Single positive supply (self biased)
- ▶ Gain: 27 dB typical at 9 GHz to 19 GHz
- ▶ OP1dB: 13.5 dB typical at 1 GHz to 9 GHz
- ▶ OIP3: 25 dBm typical at 1 GHz to 9 GHz
- ▶ Noise figure: 2.5 dB typical at 9 GHz to 19 GHz
- ▶ RoHS-compliant, 3 mm × 3 mm, 16-lead LFCSP

APPLICATIONS

- ▶ Telecommunications
- ▶ Satellite communications
- ▶ Military radar
- ▶ Weather radar
- ▶ Civil radar
- ▶ Electronic warfare

GENERAL DESCRIPTION

The ADL8102 is a gallium arsenide (GaAs), monolithic microwave integrated circuit (MMIC), pseudomorphic high electron mobility transistor (pHEMT), low noise wideband amplifier that operates from 1 GHz to 22 GHz.

The ADL8102 provides a typical gain of 27 dB at 9 GHz to 19 GHz, a 2.5 dB typical noise figure from 9 GHz to 19 GHz, a typical output third-order intercept (OIP3) of 25 dBm at 1 GHz to 9 GHz, and a saturated output power (P_{SAT}) of up to 15.5 dBm, which requires

FUNCTIONAL BLOCK DIAGRAM

Figure 1. Functional Block Diagram

only 110 mA from a 5 V supply voltage. The ADL8102 also features inputs and outputs that are internally matched to 50 Ω. The RFIN and RFOUT pins are internally AC-coupled, and the bias inductor is also integrated, which makes it ideal for surface-mounted technology (SMT)-based, high capacity microwave radio applications.

The ADL8102 is housed in an [RoHS-compliant, 3 mm × 3 mm, 16-lead LFCSP](#) package.

TABLE OF CONTENTS

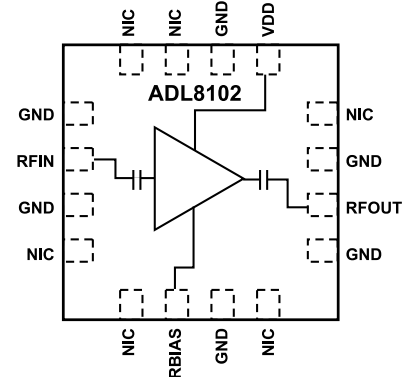
Features.....	1	ESD Caution.....	5
Applications.....	1	Pin Configuration and Function Descriptions.....	6
Functional Block Diagram.....	1	Interface Schematics.....	6
General Description.....	1	Typical Performance Characteristics.....	7
Specifications.....	3	Theory of Operation.....	19
1 GHz to 9 GHz	3	Applications Information.....	20
9 GHz to 19 GHz	3	Recommended Power Management Circuit.....	21
19 GHz to 22 GHz.....	4	Using the RBIAS Pin to Enable and Disable	
DC Specifications.....	4	the ADL8102.....	22
Absolute Maximum Ratings.....	5	Outline Dimensions.....	23
Thermal Resistance.....	5	Ordering Guide.....	23
Electrostatic Discharge (ESD) Ratings.....	5	Evaluation Boards.....	23

REVISION HISTORY**7/2023—Revision 0: Initial Version**

SPECIFICATIONS

1 GHz TO 9 GHz

Supply voltage (V_{DD}) = 5 V, quiescent current (I_{DQ}) = 110 mA, bias resistance (R_{BIAS}) = 1150 Ω , and T_{CASE} = 25°C, unless otherwise noted.

Table 1. Specifications for 1 GHz to 9 GHz

Parameter	Min	Typ	Max	Unit	Test Conditions/Comments
FREQUENCY RANGE	1		9	GHz	
GAIN (S21)	23	25.5		dB	
Gain Variation over Temperature		0.053		dB/°C	
NOISE FIGURE		3		dB	
RETURN LOSS					
Input (S11)		15		dB	
Output (S22)		18		dB	
OUTPUT					
Power for 1 dB Compression (OP1dB)	11	13.5		dBm	
Saturated Output Power (P_{SAT})		15.5		dBm	
OIP3		25		dBm	Measurement taken at P_{OUT} per tone = -4 dBm
Second-Order Intercept (OIP2)		32		dBm	Measurement taken at P_{OUT} per tone = -4 dBm
POWER ADDED EFFICIENCY (PAE)		6.5		%	Measured at P_{SAT}

9 GHz TO 19 GHz

V_{DD} = 5 V, I_{DQ} = 110 mA, R_{BIAS} = 1150 Ω , and T_{CASE} = 25°C, unless otherwise noted.

Table 2. Specifications for 9 GHz to 19 GHz

Parameter	Min	Typ	Max	Unit	Test Conditions/Comments
FREQUENCY RANGE	9		19	GHz	
S21	24.5	27		dB	
Gain Variation over Temperature		0.054		dB/°C	
NOISE FIGURE		2.5		dB	
RETURN LOSS					
S11		23		dB	
S22		15		dB	
OUTPUT					
OP1dB	11	13		dBm	
P_{SAT}		15.4		dBm	
OIP3		24.5		dBm	Measurement taken at P_{OUT} per tone = -4 dBm
OIP2		29		dBm	Measurement taken at P_{OUT} per tone = -4 dBm
PAE		6.7		%	Measured at P_{SAT}

SPECIFICATIONS

19 GHz TO 22 GHz

$V_{DD} = 5\text{ V}$, $I_{DQ} = 110\text{ mA}$, $R_{BIAS} = 1150\ \Omega$, and $T_{CASE} = 25^\circ\text{C}$, unless otherwise noted.

Table 3. Specifications for 19 GHz to 22 GHz

Parameter	Min	Typ	Max	Unit	Test Conditions/Comments
FREQUENCY RANGE	19		22	GHz	
S21	24	26.5		dB	
Gain Variation over Temperature		0.054		dB/°C	
NOISE FIGURE		3		dB	
RETURN LOSS					
S11		15		dB	
S22		20		dB	
OUTPUT					
OP1dB	10	12		dBm	
P_{SAT}		15.3		dBm	
OIP3		23		dBm	Measurement taken at P_{OUT} per tone = -4 dBm
OIP2		43		dBm	Measurement taken at P_{OUT} per tone = -4 dBm
PAE		5.5		%	Measured at P_{SAT}

DC SPECIFICATIONS

Table 4. DC Specifications

Parameter	Min	Typ	Max	Unit
SUPPLY CURRENT				
I_{DQ}		110		mA
Amplifier Current (I_{DQ_AMP})		107.15		mA
R_{BIAS} Current (I_{RBIAS})		2.85		mA
SUPPLY VOLTAGE				
V_{DD}	3	5	5.5	V

ABSOLUTE MAXIMUM RATINGS

Table 5. Absolute Maximum Ratings

Parameter	Rating
Drain Bias Voltage (V_{DD})	6.5 V
RF Input Power (RFIN)	23 dBm
Continuous Power Dissipation (P_{DISS}), $T_{CASE} = 85^{\circ}\text{C}$ (Derate 20.6 mW/ $^{\circ}\text{C}$ Above 85 $^{\circ}\text{C}$)	1.8 W
Temperature	
Storage Range	-65 $^{\circ}\text{C}$ to +150 $^{\circ}\text{C}$
Operating Range	-40 $^{\circ}\text{C}$ to +85 $^{\circ}\text{C}$
Quiescent Channel ($T_{CASE} = 85^{\circ}\text{C}$, $V_{DD} = 5\text{ V}$, $I_{DQ} = 110\text{ mA}$, Input Power (P_{IN}) = Off)	112 $^{\circ}\text{C}$
Maximum Channel	175 $^{\circ}\text{C}$

Stresses at or above those listed under Absolute Maximum Ratings may cause permanent damage to the product. This is a stress rating only; functional operation of the product at these or any other conditions above those indicated in the operational section of this specification is not implied. Operation beyond the maximum operating conditions for extended periods may affect product reliability.

THERMAL RESISTANCE

Thermal performance is directly linked to printed circuit board (PCB) design and operating environment. Careful attention to PCB thermal design is required.

θ_{JC} is the channel-to-case thermal resistance.

Table 6. Thermal Resistance¹

Package Type	θ_{JC}	Unit
CP-16-35		
Quiescent, $T_{CASE} = 25^{\circ}\text{C}$	39.4	$^{\circ}\text{C}/\text{W}$
Worst-Case ² , $T_{CASE} = 85^{\circ}\text{C}$	48.5	$^{\circ}\text{C}/\text{W}$

¹ Thermal resistance varies with operating conditions.

² Worst-case across all specified operating conditions.

ELECTROSTATIC DISCHARGE (ESD) RATINGS

The following ESD information is provided for handling of ESD-sensitive devices in an ESD protected area only.

Human body model (HBM) per ANSI/ESDA/JEDEC JS-001.

ESD Ratings for ADL8102

Table 7. ADL8102, 16-Lead LFCSP

ESD Model	Withstand Threshold (V)	Class
HBM	± 350	1A

ESD CAUTION



ESD (electrostatic discharge) sensitive device. Charged devices and circuit boards can discharge without detection. Although this product features patented or proprietary protection circuitry, damage may occur on devices subjected to high energy ESD. Therefore, proper ESD precautions should be taken to avoid performance degradation or loss of functionality.

PIN CONFIGURATION AND FUNCTION DESCRIPTIONS

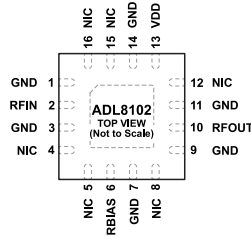

NOTES
 1. NIC = NO INTERNAL CONNECTION. THIS PIN IS NOT CONNECTED INTERNALLY. FOR NORMAL OPERATION, THIS PIN SHOULD BE CONNECTED TO GROUND.
 2. GROUND PADDLE. CONNECT THE EXPOSED GROUND PADDLE TO A GROUND PLANE WHICH HAS LOW ELECTRICAL AND THERMAL IMPEDANCE.

Figure 2. Pin Configuration

Table 8. Pin Function Descriptions

Pin Number	Mnemonic	Description
1, 3, 7, 9, 11, 14	GND	Ground. Connect to a ground plane, which has low electrical and thermal impedance. For the interface schematic, see Figure 6.
2	RFIN	RF Input. The RFIN pin is AC-coupled and matched to 50 Ω. For the interface schematic, see Figure 5.
4, 5, 8, 12, 15, 16	NIC	No Internal Connection. This pin is not connected internally. For normal operation, this pin must be connected to ground.
6	RBIAS	Bias Setting Resistor. Connect a resistor between RBIAS and VDD to set I _{DQ} . For more details, see Table 1 and Figure 75. For the interface schematic, see Figure 3.
10	RFOUT	RF Output. The RFOUT pin is AC-coupled and matched to 50 Ω. For the interface schematic, see Figure 4.
13	VDD	Drain Bias. Connect this pin to the supply voltage. For the interface schematic, see Figure 4.
	GROUND PADDLE	Ground Paddle. Connect the exposed ground paddle to a ground plane, which has low electrical and thermal impedance.

INTERFACE SCHEMATICS

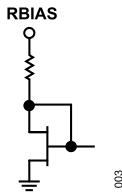

Figure 3. RBIAS Interface Schematic

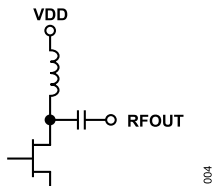

Figure 4. VDD and RFOUT Interface Schematic

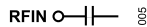

Figure 5. RFIN Interface Schematic



Figure 6. GND Interface Schematic

TYPICAL PERFORMANCE CHARACTERISTICS

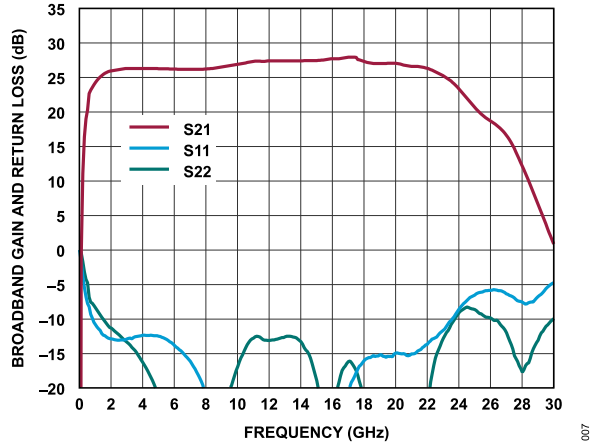

Figure 7. Broadband Gain and Return Loss vs. Frequency, $V_{DD} = 5\text{ V}$, $I_{DQ} = 110\text{ mA}$, $R_{BIAS} = 1150\ \Omega$

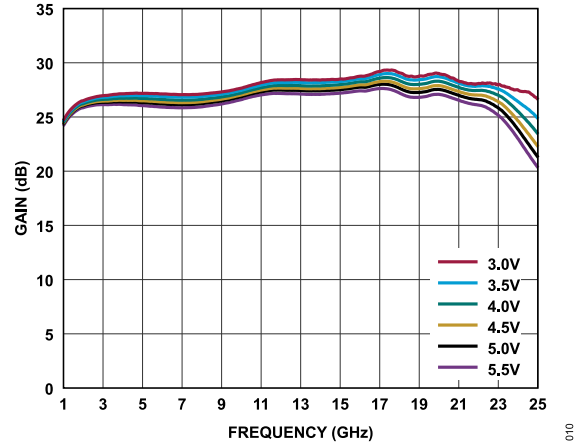

Figure 10. Gain vs. Frequency for Various Supply Voltages, 1 GHz to 25 GHz, $I_{DQ} = 110\text{ mA}$

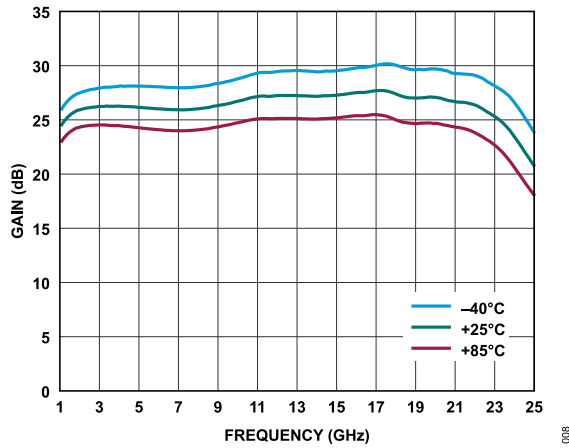

Figure 8. Gain vs. Frequency for Various Temperatures, 1 GHz to 25 GHz, $V_{DD} = 5\text{ V}$, $I_{DQ} = 110\text{ mA}$, $R_{BIAS} = 1150\ \Omega$

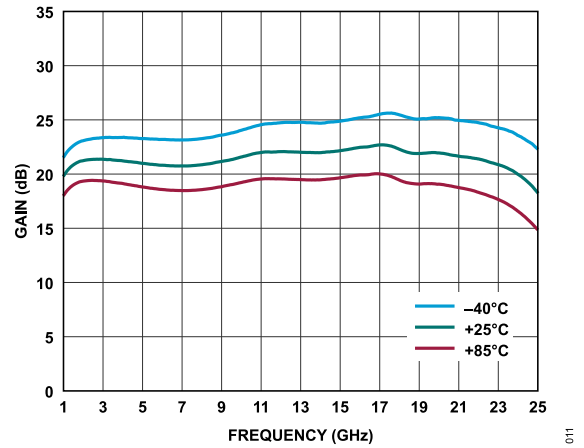

Figure 11. Gain vs. Frequency for Various Temperatures, 1 GHz to 25 GHz, $V_{DD} = 3\text{ V}$, $I_{DQ} = 47\text{ mA}$, $R_{BIAS} = 1150\ \Omega$

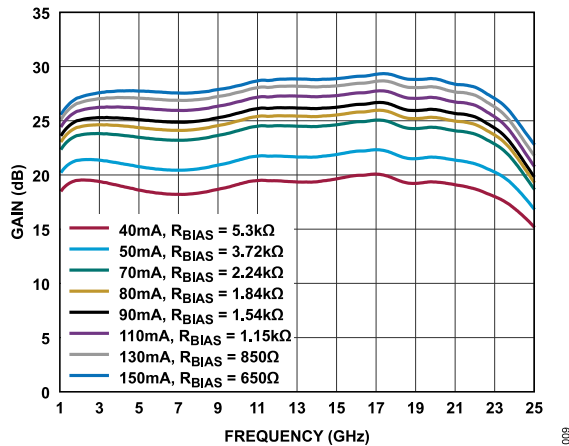

Figure 9. Gain vs. Frequency for Various I_{DQ} and R_{BIAS} Values, 1 GHz to 25 GHz, $V_{DD} = 5\text{ V}$

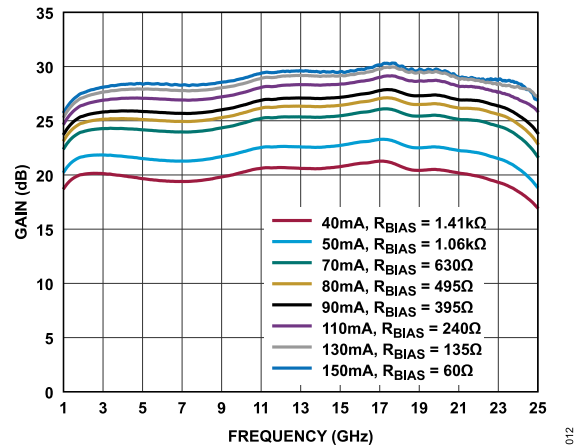

Figure 12. Gain vs. Frequency for Various I_{DQ} and R_{BIAS} Values, 1 GHz to 25 GHz, $V_{DD} = 3\text{ V}$

TYPICAL PERFORMANCE CHARACTERISTICS

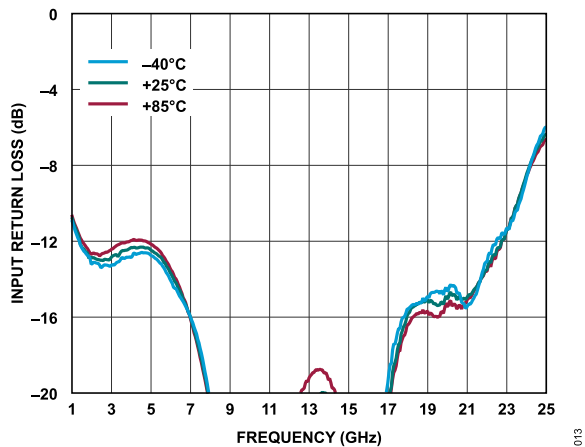

Figure 13. Input Return Loss vs. Frequency for Various Temperatures, 1 GHz to 25 GHz, $V_{DD} = 5\text{ V}$, $I_{DQ} = 110\text{ mA}$, $R_{BIAS} = 1150\ \Omega$

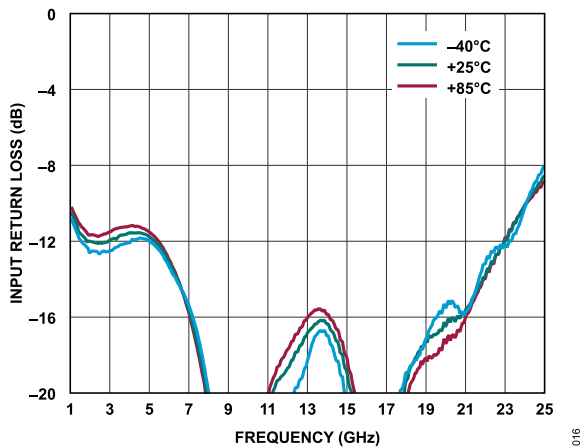

Figure 16. Input Return Loss vs. Frequency for Various Temperatures, 1 GHz to 25 GHz, $V_{DD} = 3\text{ V}$, $I_{DQ} = 47\text{ mA}$, $R_{BIAS} = 1150\ \Omega$

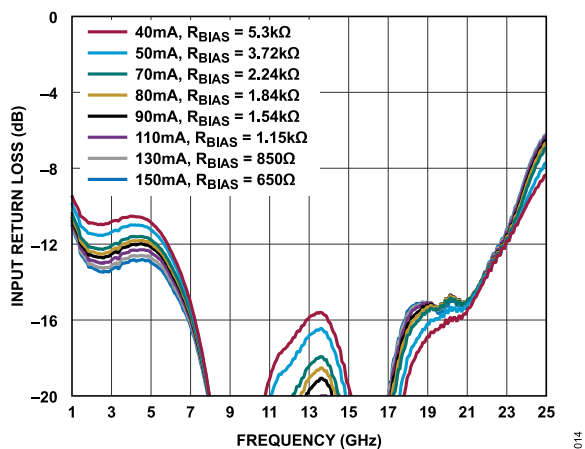

Figure 14. Input Return Loss vs. Frequency for Various I_{DQ} and R_{BIAS} Values, 1 GHz to 25 GHz, $V_{DD} = 5\text{ V}$

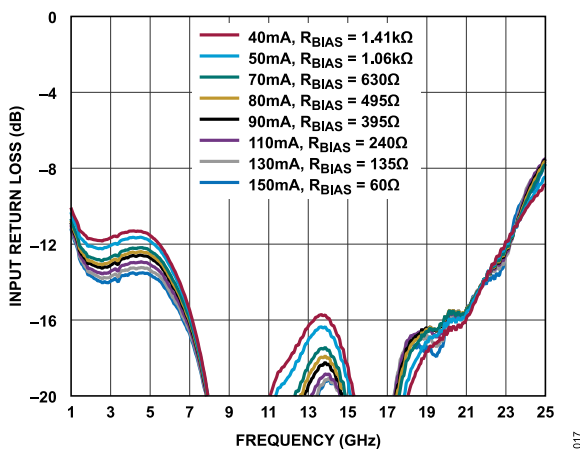

Figure 17. Input Return Loss vs. Frequency for Various I_{DQ} and R_{BIAS} Values, 1 GHz to 25 GHz, $V_{DD} = 3\text{ V}$

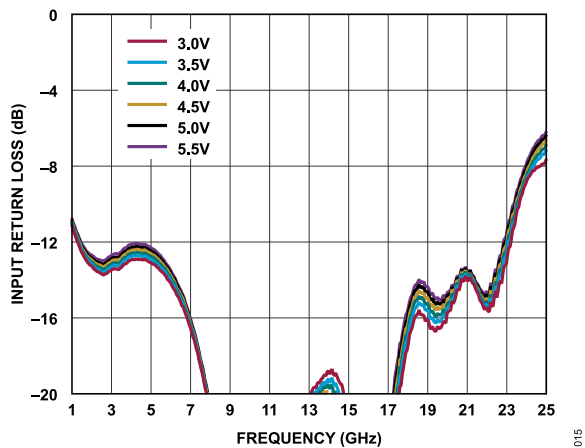

Figure 15. Input Return Loss vs. Frequency for Various Supply Voltages, 1 GHz to 25 GHz, $I_{DQ} = 110\text{ mA}$

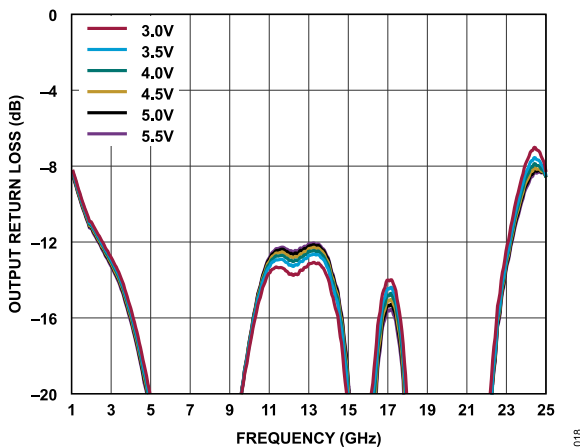

Figure 18. Output Return Loss vs. Frequency for Various Supply Voltages, 1 GHz to 25 GHz, $I_{DQ} = 110\text{ mA}$

TYPICAL PERFORMANCE CHARACTERISTICS

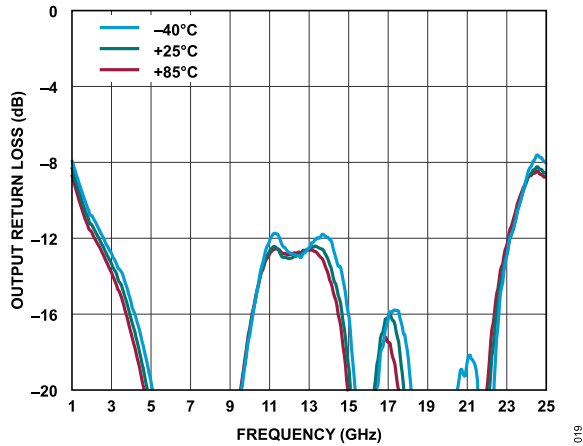

Figure 19. Output Return Loss vs. Frequency for Various Temperatures, 1 GHz to 25 GHz, $V_{DD} = 5\text{ V}$, $I_{DQ} = 110\text{ mA}$, $R_{BIAS} = 1150\ \Omega$

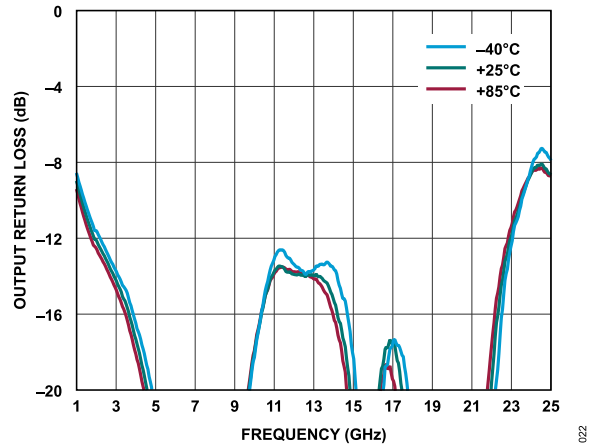

Figure 22. Output Return Loss vs. Frequency for Various Temperatures, 1 GHz to 25 GHz, $V_{DD} = 3\text{ V}$, $I_{DQ} = 47\text{ mA}$, $R_{BIAS} = 1150\ \Omega$

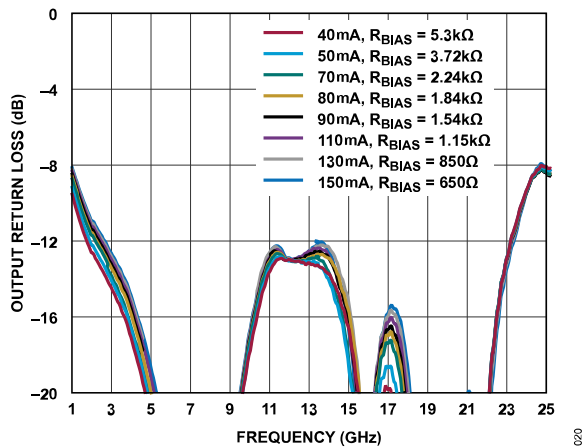

Figure 20. Output Return Loss vs. Frequency for Various I_{DQ} and R_{BIAS} Values, 1 GHz to 25 GHz, $V_{DD} = 5\text{ V}$

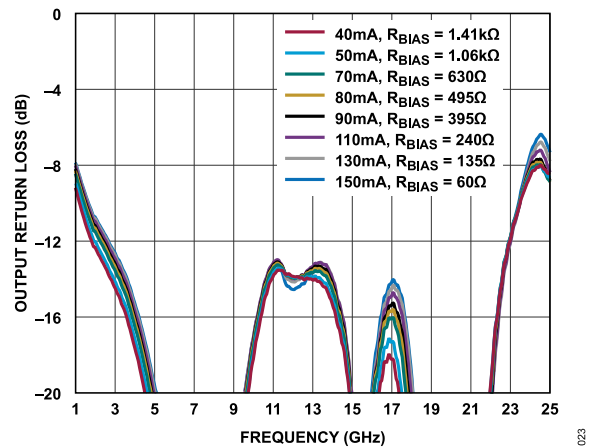

Figure 23. Output Return Loss vs. Frequency for Various I_{DQ} and R_{BIAS} Values, 1 GHz to 25 GHz, $V_{DD} = 3\text{ V}$

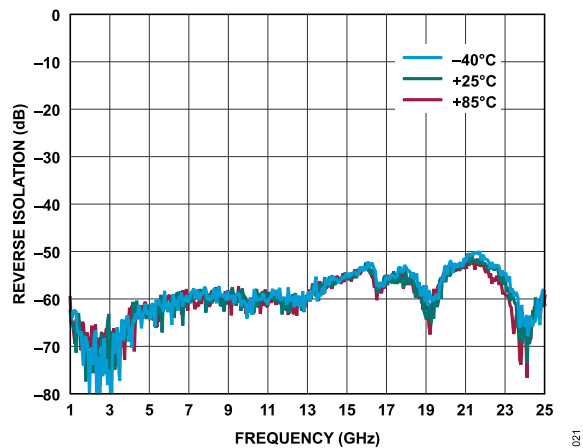

Figure 21. Reverse Isolation vs. Frequency for Various Temperatures, 1 GHz to 25 GHz, $V_{DD} = 5\text{ V}$, $I_{DQ} = 110\text{ mA}$, $R_{BIAS} = 1150\ \Omega$

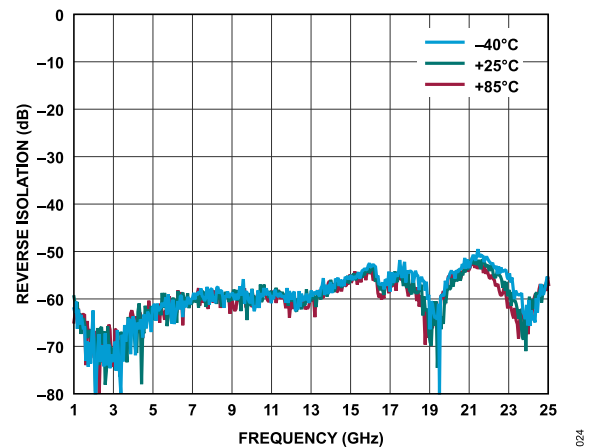

Figure 24. Reverse Isolation vs. Frequency for Various Temperatures, 1 GHz to 25 GHz, $V_{DD} = 3\text{ V}$, $I_{DQ} = 47\text{ mA}$, $R_{BIAS} = 1150\ \Omega$

TYPICAL PERFORMANCE CHARACTERISTICS

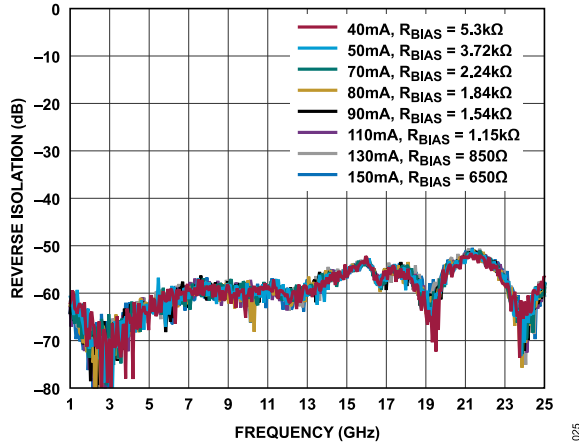

Figure 25. Reverse Isolation vs. Frequency for Various I_{DQ} and R_{BIAS} Values, 1 GHz to 25 GHz, $V_{DD} = 5\text{ V}$

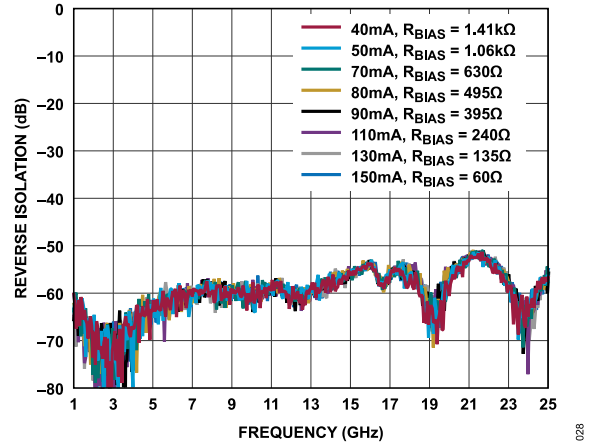

Figure 28. Reverse Isolation vs. Frequency for Various I_{DQ} and R_{BIAS} Values, 1 GHz to 25 GHz, $V_{DD} = 3\text{ V}$

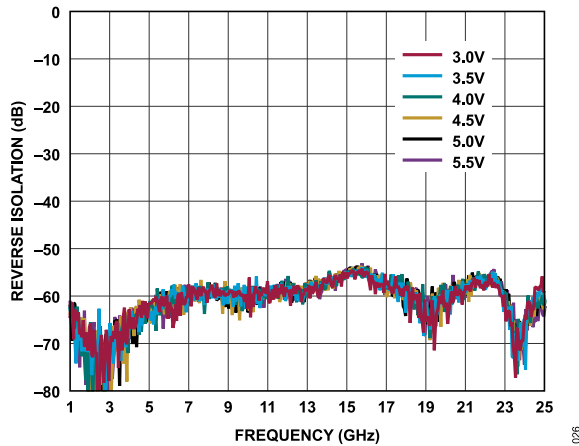

Figure 26. Reverse Isolation vs. Frequency for Various Supply Voltages, 1 GHz to 25 GHz, $I_{DQ} = 110\text{ mA}$

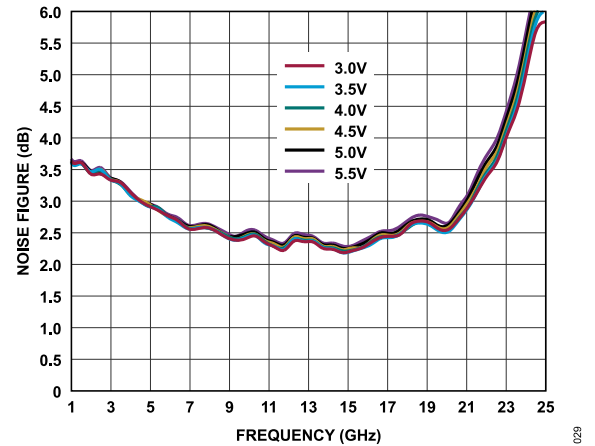

Figure 29. Noise Figure vs. Frequency for Various Supply Voltages, 1 GHz to 25 GHz, $I_{DQ} = 110\text{ mA}$

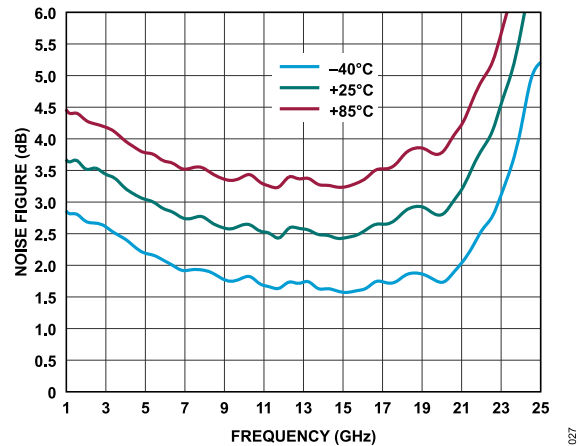

Figure 27. Noise Figure vs. Frequency for Various Temperatures, 1 GHz to 25 GHz, $V_{DD} = 5\text{ V}$, $I_{DQ} = 110\text{ mA}$, $R_{BIAS} = 1150\ \Omega$

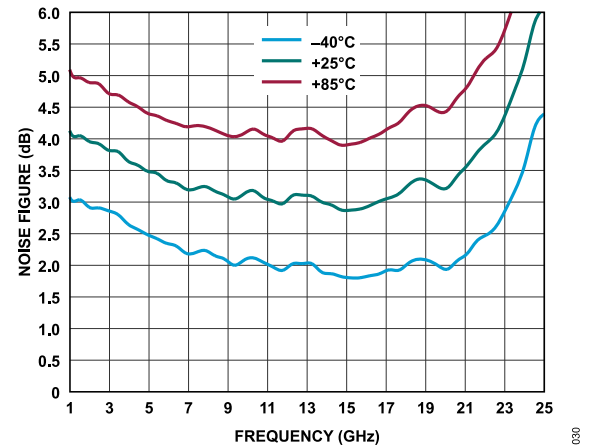

Figure 30. Noise Figure vs. Frequency for Various Temperatures, 1GHz to 25 GHz, $V_{DD} = 3\text{ V}$, $I_{DQ} = 47\text{ mA}$, $R_{BIAS} = 1150\ \Omega$

TYPICAL PERFORMANCE CHARACTERISTICS

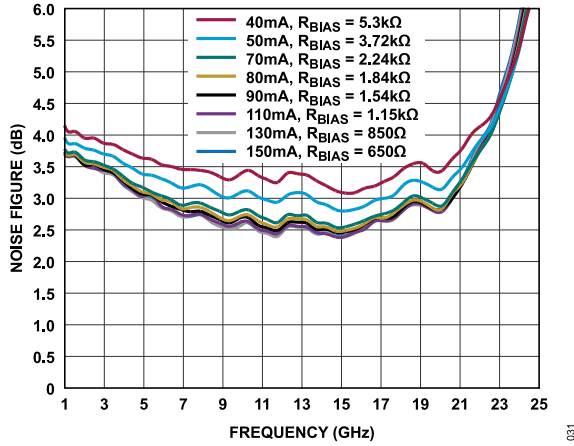

Figure 31. Noise Figure vs. Frequency for Various I_{DQ} and R_{BIAS} Values, 1 GHz to 25 GHz, $V_{DD} = 5$ V

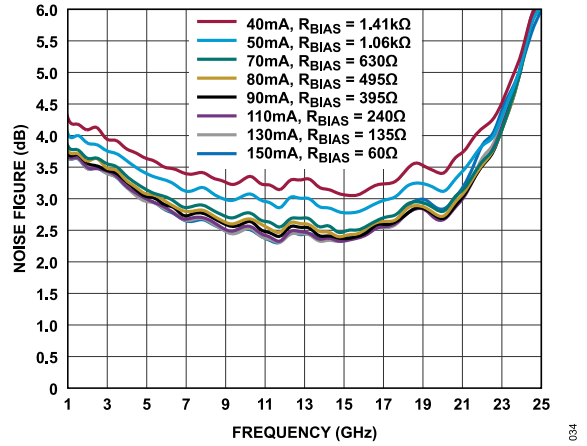

Figure 34. Noise Figure vs. Frequency for Various I_{DQ} and R_{BIAS} Values, 1 GHz to 25 GHz, $V_{DD} = 3$ V

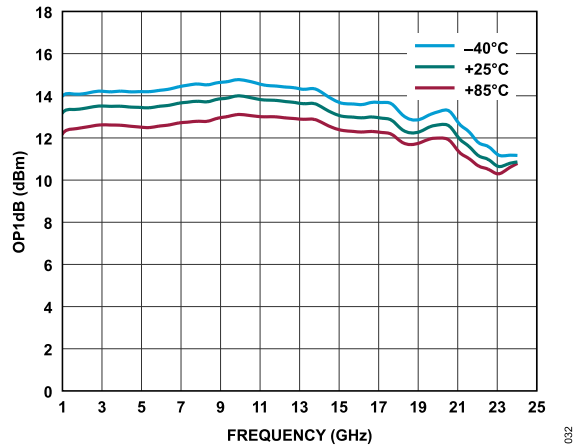

Figure 32. OP1dB vs. Frequency for Various Temperatures, 1 GHz to 24 GHz, $V_{DD} = 5$ V, $I_{DQ} = 110$ mA, $R_{BIAS} = 1150$ Ω

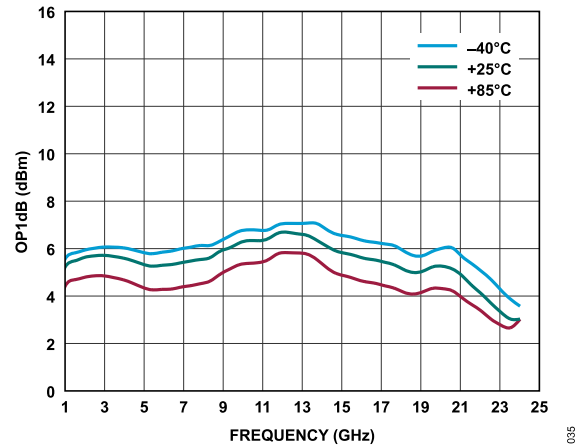

Figure 35. OP1dB vs. Frequency for Various Temperatures, 1 GHz to 24 GHz, $V_{DD} = 3$ V, $I_{DQ} = 47$ mA, $R_{BIAS} = 1150$ Ω

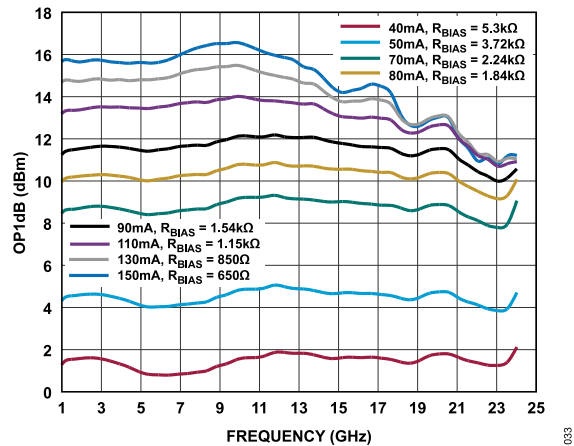

Figure 33. OP1dB vs. Frequency for Various I_{DQ} and R_{BIAS} Values, 1 GHz to 24 GHz, $V_{DD} = 5$ V

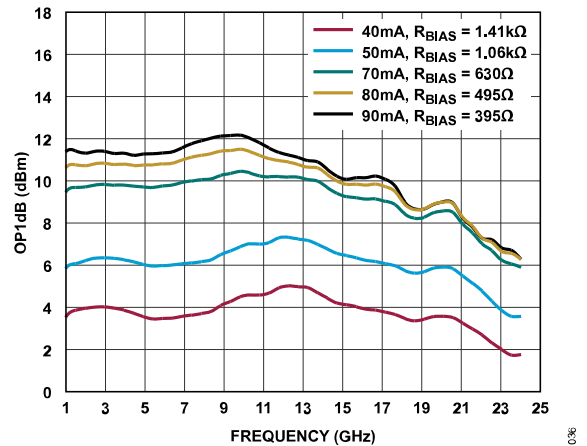

Figure 36. OP1dB vs. Frequency for Various I_{DQ} and R_{BIAS} Values, 1 GHz to 24 GHz, $V_{DD} = 3$ V

TYPICAL PERFORMANCE CHARACTERISTICS

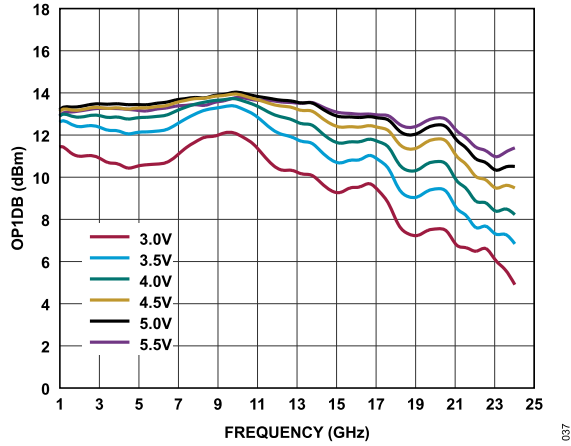

Figure 37. OP1dB vs. Frequency for Various Supply Voltages, 1 GHz to 24 GHz, $I_{DQ} = 110 \text{ mA}$

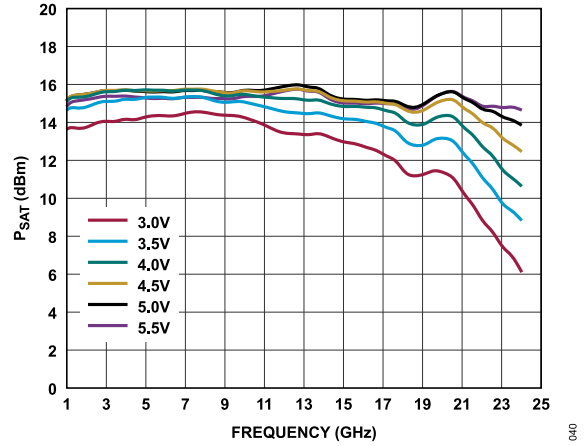

Figure 40. P_{SAT} vs. Frequency for Various Supply Voltages, 1 GHz to 24 GHz, $I_{DQ} = 110 \text{ mA}$

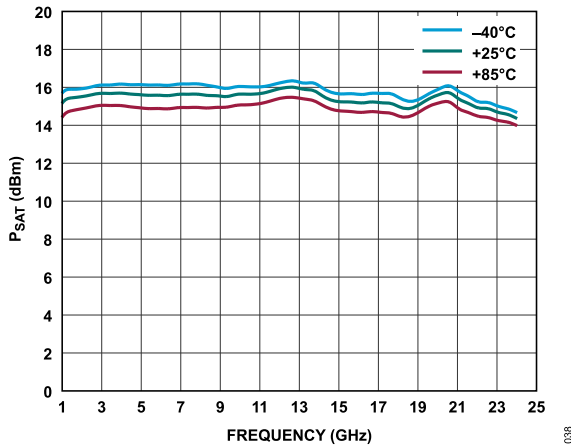

Figure 38. P_{SAT} vs. Frequency for Various Temperatures, 1 GHz to 24 GHz, $V_{DD} = 5 \text{ V}$, $I_{DQ} = 110 \text{ mA}$, $R_{BIAS} = 1150 \Omega$

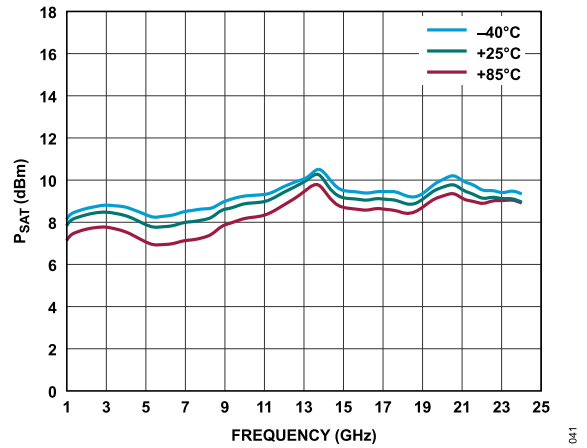

Figure 41. P_{SAT} vs. Frequency for Various Temperatures, 1 GHz to 24 GHz, $V_{DD} = 3 \text{ V}$, $I_{DQ} = 47 \text{ mA}$, $R_{BIAS} = 1150 \Omega$

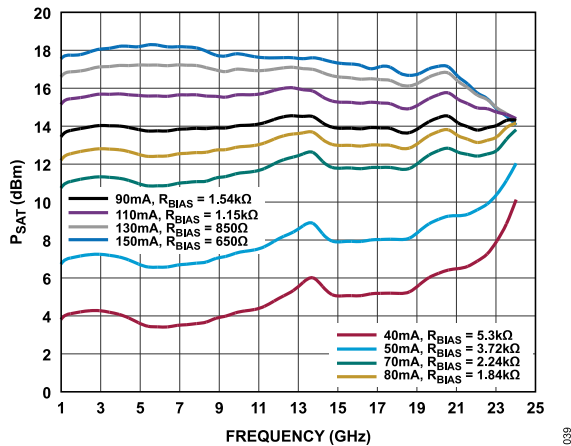

Figure 39. P_{SAT} vs. Frequency for Various I_{DQ} and R_{BIAS} Values, 1 GHz to 24 GHz, $V_{DD} = 5 \text{ V}$

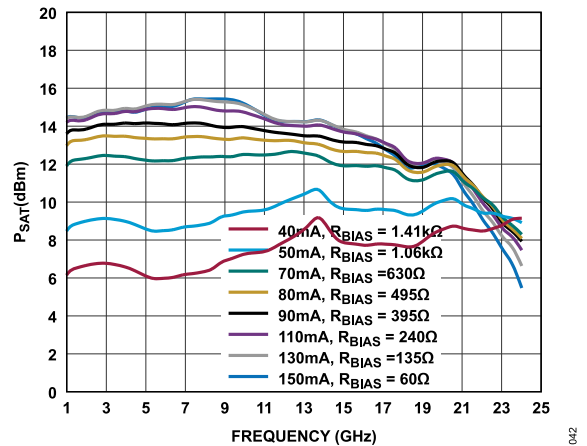

Figure 42. P_{SAT} vs. Frequency for Various I_{DQ} and R_{BIAS} Values, 1 GHz to 24 GHz, $V_{DD} = 3 \text{ V}$

TYPICAL PERFORMANCE CHARACTERISTICS

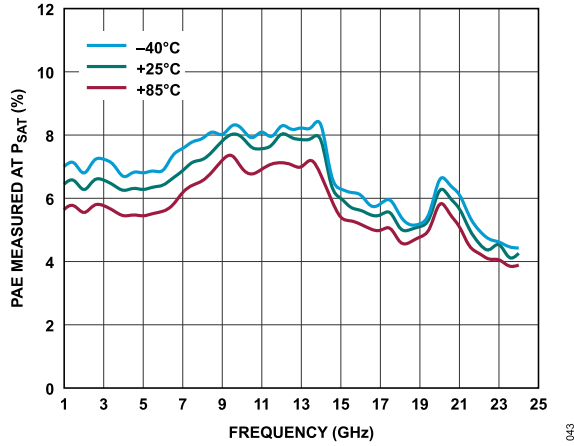

Figure 43. PAE Measured at P_{SAT} vs. Frequency for Various Temperatures, 1 GHz to 24 GHz, $V_{DD} = 5\text{ V}$, $I_{DQ} = 110\text{ mA}$, $R_{BIAS} = 1150\ \Omega$

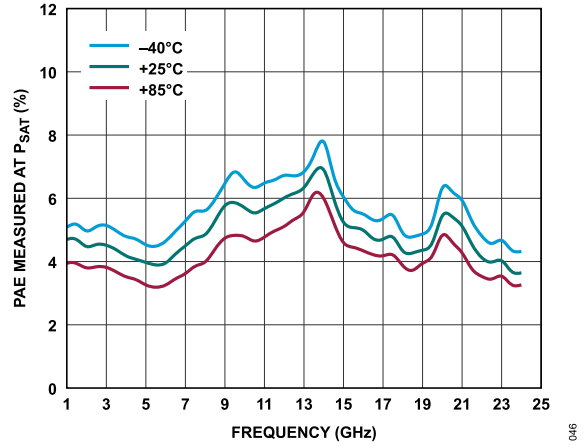

Figure 46. PAE Measured at P_{SAT} vs. Frequency for Various Temperatures, 1 GHz to 24 GHz, $V_{DD} = 3\text{ V}$, $I_{DQ} = 47\text{ mA}$, $R_{BIAS} = 1150\ \Omega$

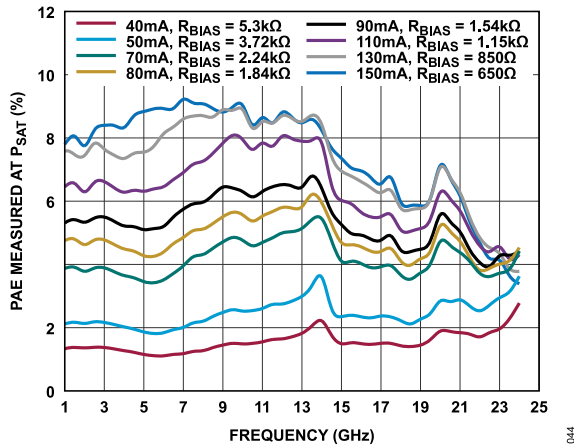

Figure 44. PAE Measured at P_{SAT} vs. Frequency for Various I_{DQ} and R_{BIAS} Values, 1 GHz to 24 GHz, $V_{DD} = 5\text{ V}$

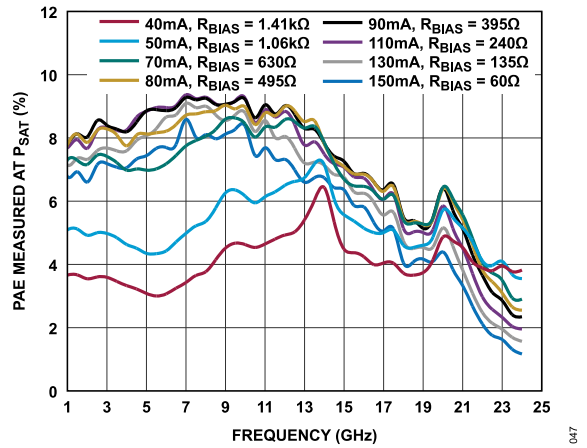

Figure 47. PAE Measured at P_{SAT} vs. Frequency for Various I_{DQ} and R_{BIAS} Values, 1 GHz to 24 GHz, $V_{DD} = 3\text{ V}$

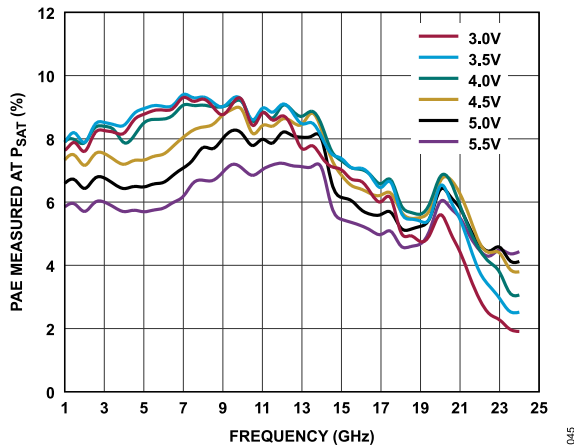

Figure 45. PAE Measured at P_{SAT} vs. Frequency for Various Supply Voltages, 1 GHz to 24 GHz, $I_{DQ} = 110\text{ mA}$

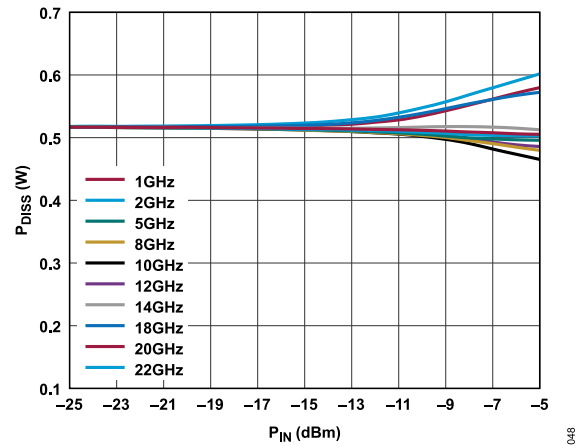

Figure 48. P_{DISS} vs. P_{IN} at Various Frequencies, $T_{CASE} = 85^\circ\text{C}$, $V_{DD} = 5\text{ V}$

TYPICAL PERFORMANCE CHARACTERISTICS

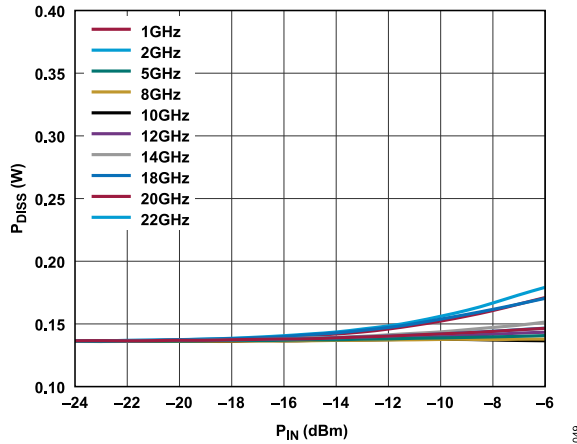

Figure 49. P_{DISS} vs. P_{IN} at Various Frequencies, $T_{CASE} = 85^{\circ}C$, $V_{DD} = 3 V$

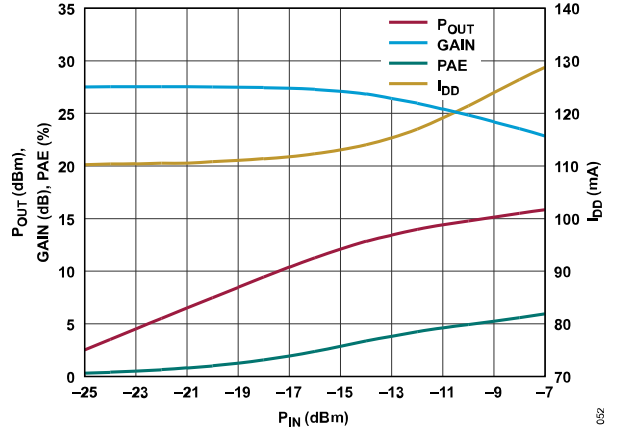

Figure 52. P_{OUT} , Gain, PAE, and I_{DD} vs. P_{IN} , Power Compression at 20 GHz, $V_{DD} = 5 V$, $R_{BIAS} = 1150 \Omega$

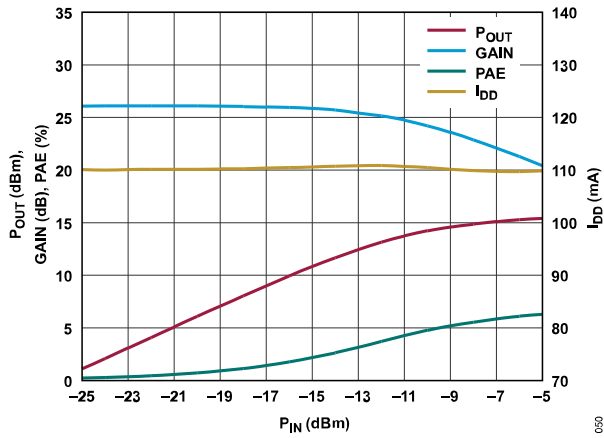

Figure 50. P_{OUT} , Gain, PAE, and I_{DD} vs. P_{IN} , Power Compression at 5 GHz, $V_{DD} = 5 V$, $R_{BIAS} = 1150 \Omega$

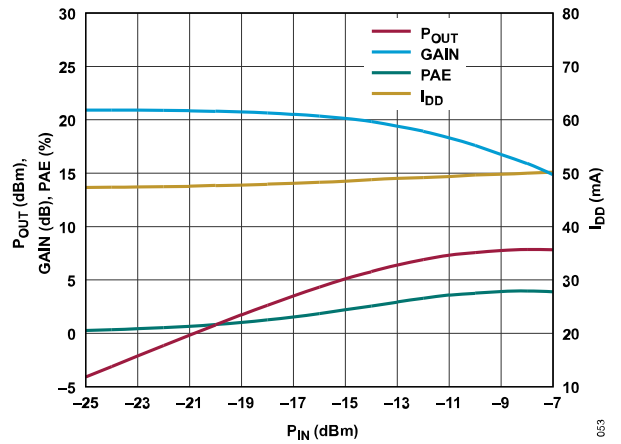

Figure 53. P_{OUT} , Gain, PAE, and I_{DD} vs. P_{IN} , Power Compression at 5 GHz, $V_{DD} = 3 V$, $R_{BIAS} = 1150 \Omega$

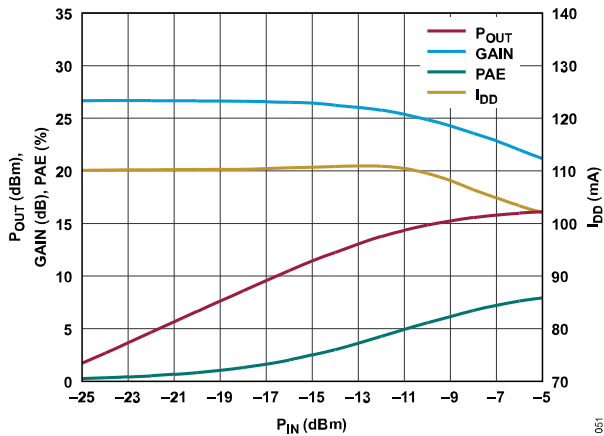

Figure 51. P_{OUT} , Gain, PAE, and I_{DD} vs. P_{IN} , Power Compression at 10 GHz, $V_{DD} = 5 V$, $R_{BIAS} = 1150 \Omega$

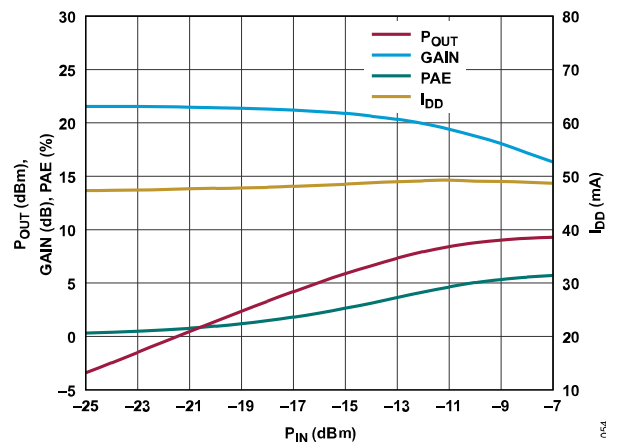

Figure 54. P_{OUT} , Gain, PAE, and I_{DD} vs. P_{IN} , Power Compression at 10 GHz, $V_{DD} = 3 V$, $R_{BIAS} = 1150 \Omega$

TYPICAL PERFORMANCE CHARACTERISTICS

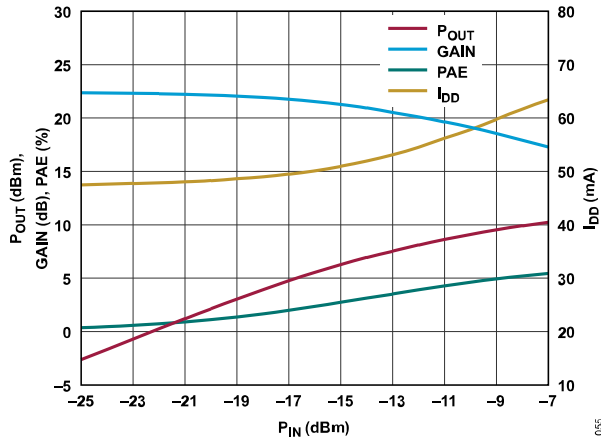

Figure 55. P_{OUT} , Gain, PAE, and I_{DD} vs. P_{IN} , Power Compression at 20 GHz, $V_{DD} = 3\text{ V}$, $R_{BIAS} = 1150\ \Omega$

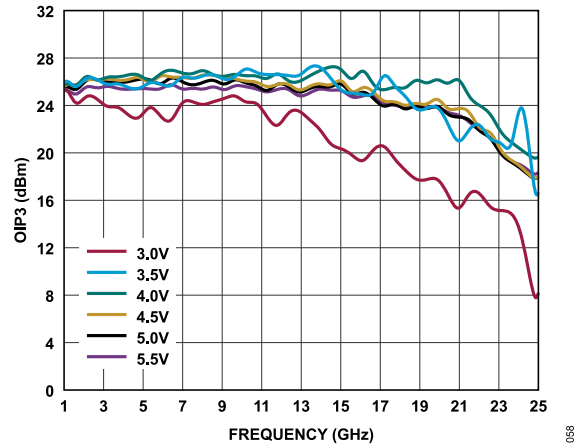

Figure 58. OIP3 vs. Frequency for Various Supply Voltages, 1 GHz to 25 GHz, $I_{DQ} = 110\text{ mA}$

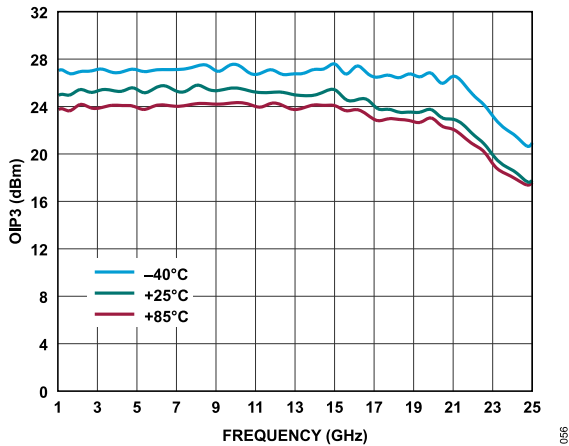

Figure 56. OIP3 vs. Frequency for Various Temperatures, 1 GHz to 25 GHz, $V_{DD} = 5\text{ V}$, $I_{DQ} = 110\text{ mA}$, $R_{BIAS} = 1150\ \Omega$

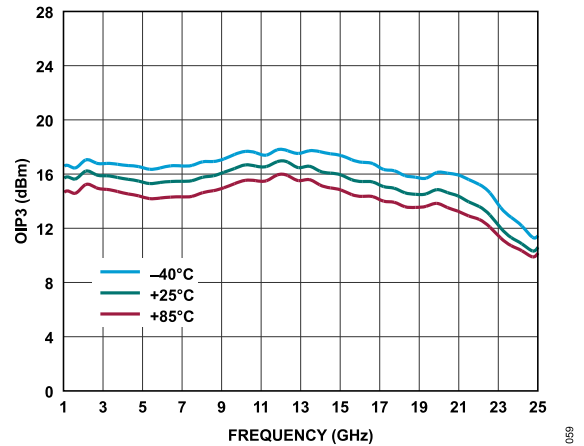

Figure 59. OIP3 vs. Frequency for Various Temperatures, 1 GHz to 25 GHz, $V_{DD} = 3\text{ V}$, $I_{DQ} = 47\text{ mA}$, $R_{BIAS} = 1150\ \Omega$

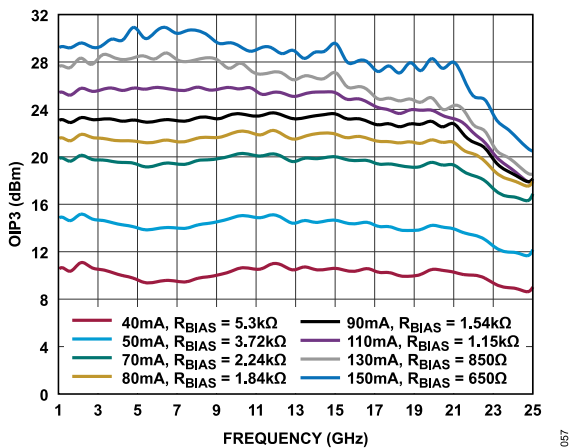

Figure 57. OIP3 vs. Frequency for Various I_{DQ} and R_{BIAS} Values, 1 GHz to 25 GHz, $V_{DD} = 5\text{ V}$

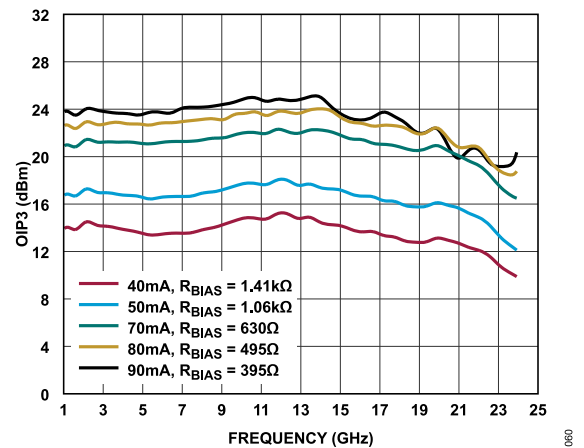

Figure 60. OIP3 vs. Frequency for Various I_{DQ} and R_{BIAS} Values, 1 GHz to 24 GHz, $V_{DD} = 3\text{ V}$

TYPICAL PERFORMANCE CHARACTERISTICS

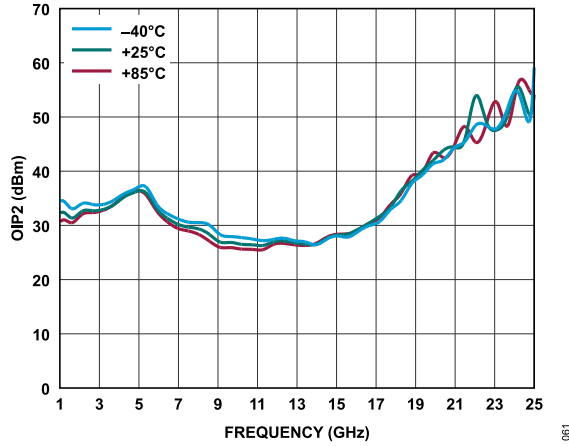

Figure 61. OIP2 vs. Frequency for Various Temperatures, 1 GHz to 25 GHz, $V_{DD} = 5\text{ V}$, $I_{DQ} = 110\text{ mA}$, $R_{BIAS} = 1150\ \Omega$

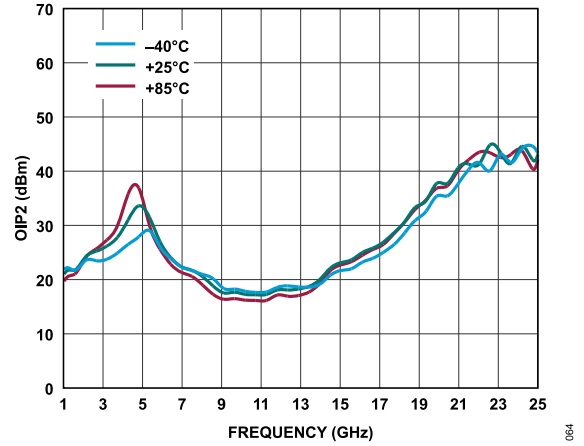

Figure 64. OIP2 vs. Frequency for Various Temperatures, 1 GHz to 25 GHz, $V_{DD} = 3\text{ V}$, $I_{DQ} = 47\text{ mA}$, $R_{BIAS} = 1150\ \Omega$

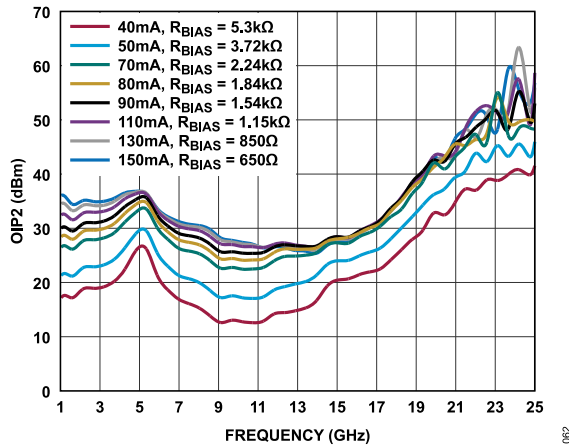

Figure 62. OIP2 vs. Frequency for Various I_{DQ} and R_{BIAS} Values, 1 GHz to 25 GHz, $V_{DD} = 5\text{ V}$

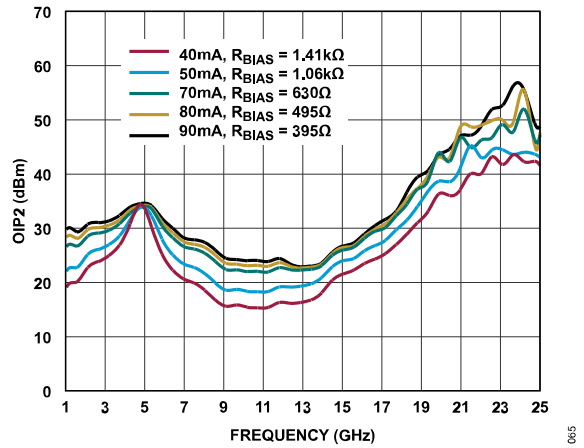

Figure 65. OIP2 vs. Frequency for Various I_{DQ} and R_{BIAS} Values, 1 GHz to 25 GHz, $V_{DD} = 3\text{ V}$

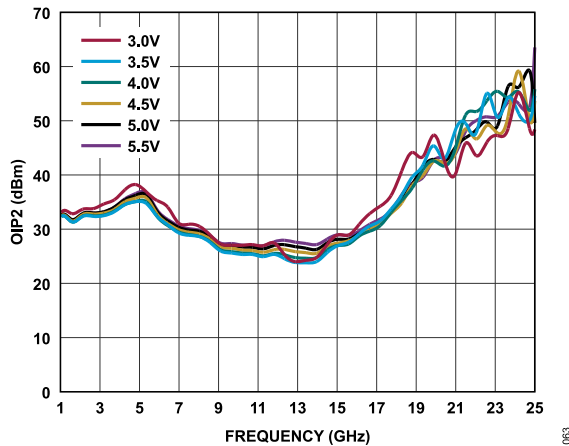

Figure 63. OIP2 vs. Frequency for Various Supply Voltages, 1 GHz to 25 GHz, $I_{DQ} = 110\text{ mA}$

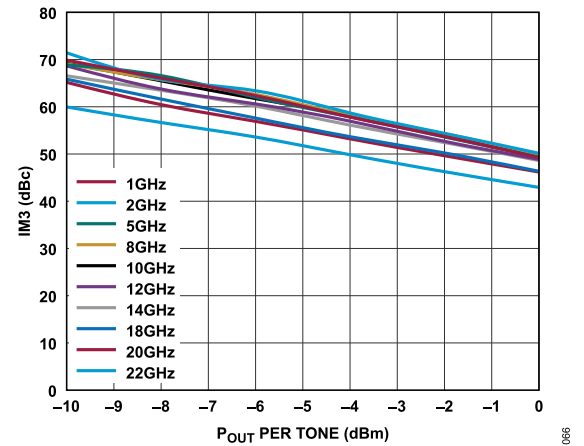

Figure 66. Third-Order Intermodulation (IM3) vs. P_{OUT} Per Tone for Various Frequencies, $V_{DD} = 5\text{ V}$, $R_{BIAS} = 1150\ \Omega$

TYPICAL PERFORMANCE CHARACTERISTICS

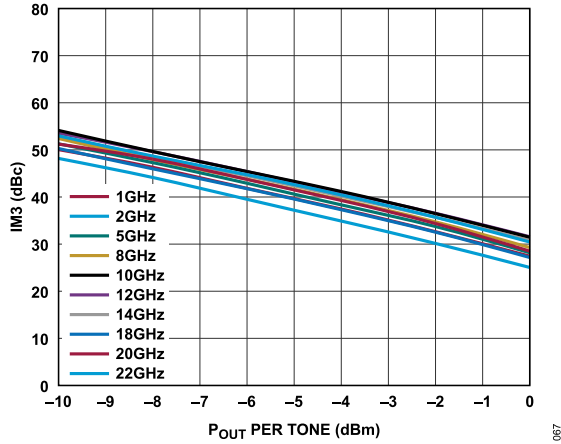

Figure 67. IM3 vs. P_{OUT} Per Tone for Various Frequencies, $V_{DD} = 3\text{ V}$, $R_{BIAS} = 1150\ \Omega$

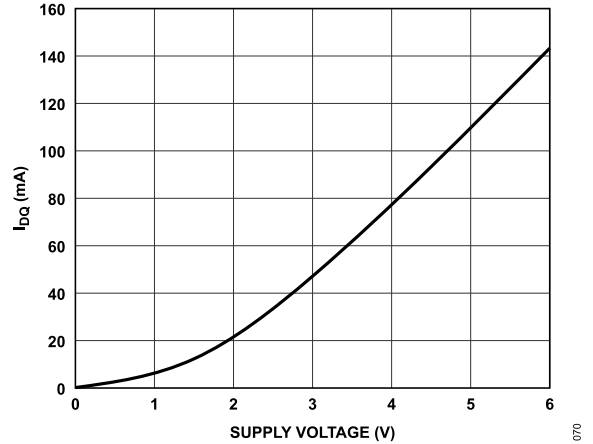

Figure 70. I_{DQ} vs. Supply Voltage, $R_{BIAS} = 1150\ \Omega$

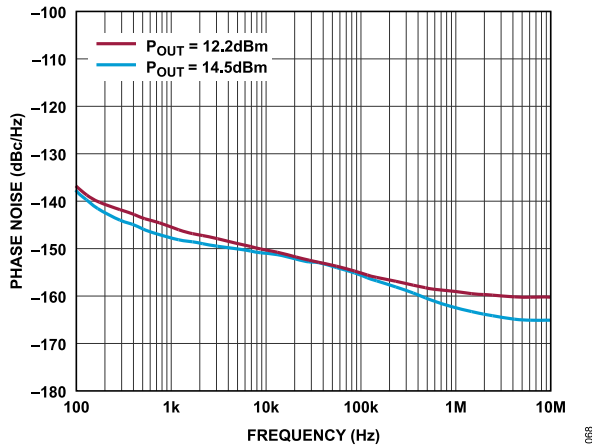

Figure 68. Phase Noise vs. Frequency at 5 GHz for Various P_{OUT} Values

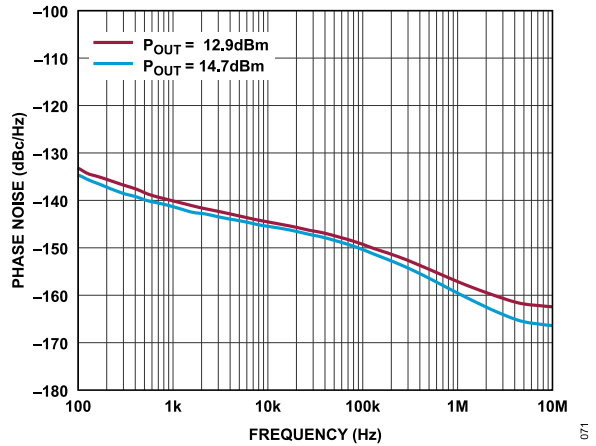

Figure 71. Phase Noise vs. Frequency at 15 GHz for Various P_{OUT} Values

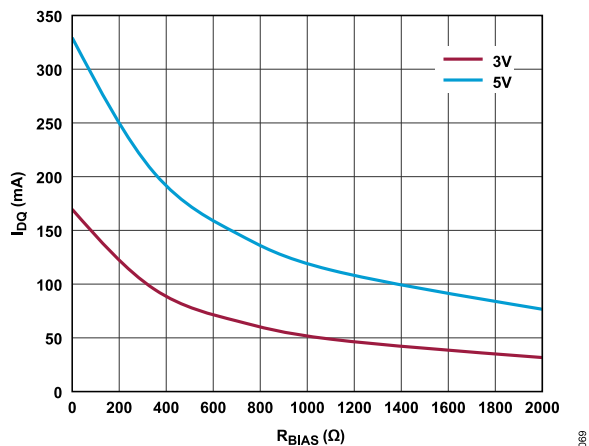

Figure 69. I_{DQ} vs. R_{BIAS} at Various Supply Voltages, 0 Ω to 2000 Ω

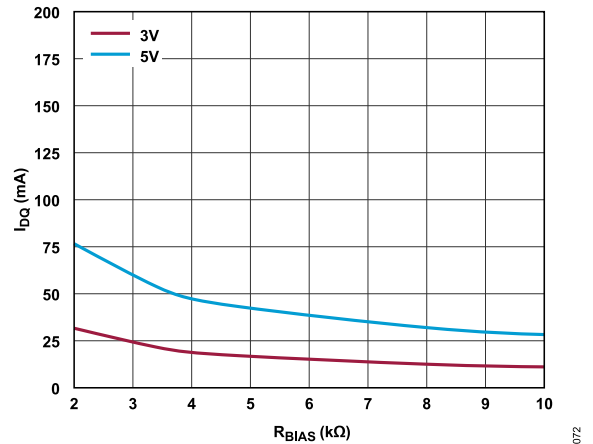

Figure 72. I_{DQ} vs. R_{BIAS} at Various Supply Voltages, 2 k Ω to 10 k Ω

TYPICAL PERFORMANCE CHARACTERISTICS

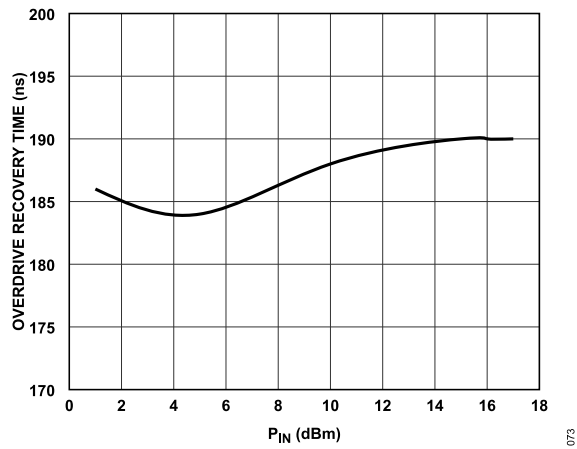

Figure 73. Overdrive Recovery Time vs. P_{IN} at 10 GHz, Recovery to Within 90% of Small Signal Gain Value, $V_{DD} = 5\text{ V}$, $R_{BIAS} = 1.15\text{ k}\Omega$

THEORY OF OPERATION

The ADL8102 has AC-coupled, single-ended input and output ports with impedance that are nominally equal to $50\ \Omega$ over the 1 GHz to 22 GHz frequency range. No external matching components are required. To adjust I_{DQ} , connect an external resistor between the RBIAS and VDD pins. Figure 74 shows the simplified block diagram.

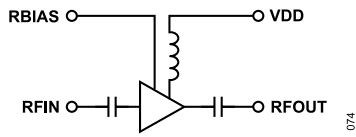

Figure 74. Simplified Schematic

APPLICATIONS INFORMATION

The basic connections for operating the ADL8102 over the specified frequency range are shown in Figure 75. No external biasing inductor is required, which allows the 5 V supply to be connected to the VDD pin. It is recommended to use 1 μ F, 100 pF, and 1000 pF power-supply decoupling capacitors. The power-supply decoupling capacitors shown in Figure 75 represent the configuration used to characterize and qualify the ADL8102.

To set I_{DQ} , connect a resistor (R1) between the RBIAS and VDD pins. A default value of 1150 Ω is recommended, which results in a nominal I_{DQ} of 110 mA. Table 1 shows how I_{DQ} and I_{DQ_AMP} vary vs. R_{BIAS} . The RBIAS pin also draws a current that varies with the value of R_{BIAS} (see Table 1). Do not leave the RBIAS pin open.

Correct sequencing of the DC and RF power is required to safely operate the ADL8102. During power-up, apply V_{DD} before the RF power is applied to RFIN, and during power-off, remove the RF power from RFIN before V_{DD} is powered off.

For more information on using the evaluation board, refer to the ADL8102-EVALZ user guide.

Table 9. Recommended R_{BIAS} Values for $V_{DD} = 5$ V

R_{BIAS} (k Ω)	I_{DQ} (mA)	I_{DQ_AMP} (mA)	I_{RBIAS} (mA)
5.3	40	39.2	0.8
3.72	50	48.9	1.1
2.24	70	68.3	1.7
1.84	80	78	2
1.54	90	87.75	2.25
1.15	110	107.15	2.85
0.85	130	126.55	3.45
0.65	150	146	4

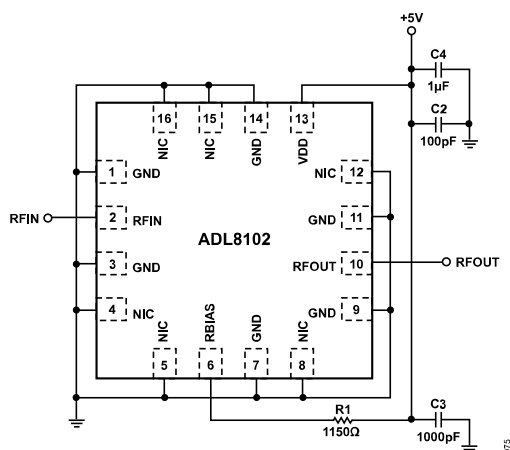

Figure 75. Typical Application Circuit

RECOMMENDED POWER MANAGEMENT CIRCUIT

Figure 76 shows a recommended power management circuit for the ADL8102. The LT8607 step-down regulator is used to step down a 12 V rail to 6.5 V, which is then applied to the LT3042 low dropout (LDO) linear regulator to generate a low noise 5 V output. While the circuit shown in Figure 76 has an input voltage of 12 V, the input range to the LT8607 can be as high as 42 V.

The 6.5 V regulator output of the LT8607 is set by the R2 and R3 resistors according to the following equation:

$$R2 = R3((VOUT / 0.778 V) - 1) \quad (1)$$

The switching frequency is set to 2 MHz by the 18.2 kΩ resistor on the RT pin. The LT8607 data sheet provides a table of resistor values that can be used to select other switching frequencies ranging from 0.2 MHz to 2.200 MHz.

The output voltage of the LT3042 is set by the R4 resistor connected to the SET pin according to the following equation:

$$VOUT = 100 \mu A \times R4 \quad (2)$$

Choose PGFB resistors to trigger the power-good (PG) signal when the output is just under 95% of the target voltage of 5 V. The output of the LT3042 has 1% initial tolerance and another 1%

variation over temperature. The PGFB tolerance is roughly 3% over temperature, and adding resistors results in a bit more (5%), therefore, putting 5% between the output and PGFB works well. In addition, the PG open-collector is pulled up to the 5 V output to give a convenient 0 V to 5 V voltage range. Table 10 provides the recommended resistor values for operation at 5 V, 3.3 V, and 3 V.

Table 10. Recommended Resistor Values for Operating at 5 V, 3.3 V, and 3 V

LDO Output Voltage (V)	R4 (kΩ)	R7 (kΩ)	R8 (kΩ)
5	49.9	442	30.1
3.3	33.2	287	30.1
3	30.1	255	30.1

The LT8607 can source a maximum current of 750 mA, and the LT3042 can source a maximum current of 200 mA. If the 5 V power supply voltage is being developed as a bus supply to serve another component, higher current devices can be used. The LT8608 and LT8609 step-down regulators can source a maximum current to 1.5 A and 3 A, respectively, and these devices are pin-compatible with the LT8607. The LT3045 linear regulator, which is pin-compatible with the LT3042, can source a maximum current to 500 mA.

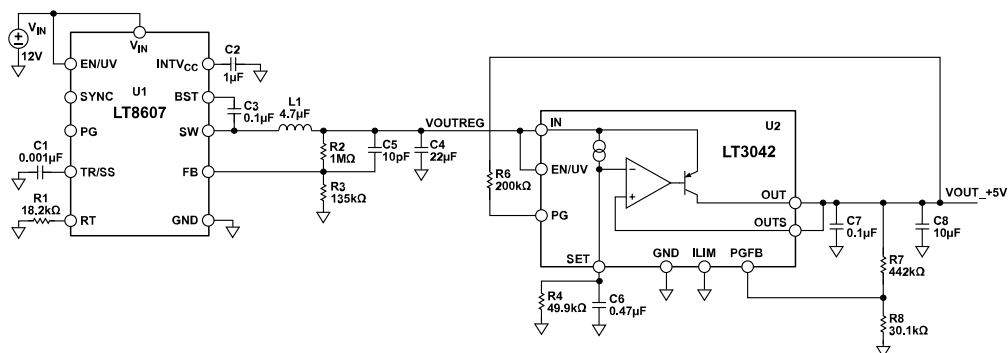

Figure 76. Recommended Power Management Circuit

USING THE RBIAS PIN TO ENABLE AND DISABLE THE ADL8102

By attaching a single-pole, double throw (SPDT) switch to the RBIAS pin, an enable and/or disable circuit can be implemented as shown in Figure 77. The ADG719 CMOS switch is used to connect the R_{BIAS} resistor either to supply or ground. When the R_{BIAS} resistor is connected to ground, the overall current consumption reduces to 4.73 mA with no RF signal present and 4.92 mA when the RF input level is -10 dBm.

Figure 78 shows a plot of the turn on and/or turn off response time of the RF output envelope when the IN pin of the ADG719 is pulsed.

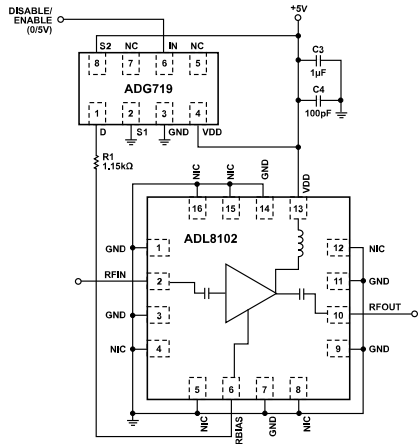

Figure 77. Fast Enable and/or Disable Circuit Using an SPDT

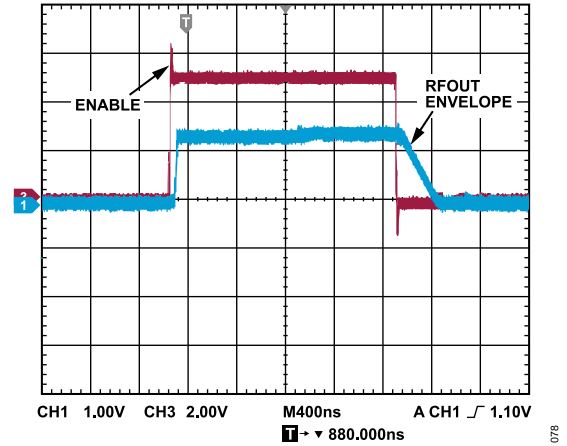
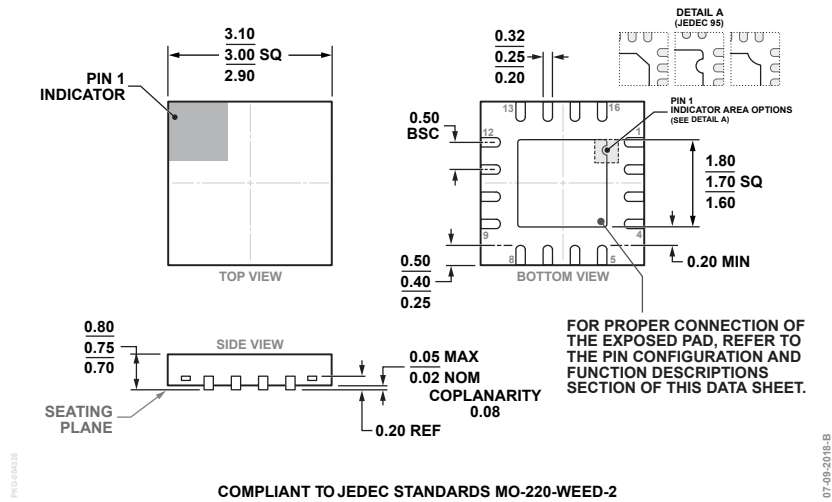

Figure 78. On and/or Off Response of the RF Output Envelope When the IN Pin of the ADG719 Is Pulsed

OUTLINE DIMENSIONS



**Figure 79. 16-Lead Lead Frame Chip-Scale Package [LF CSP]
3 mm x 3 mm Body and 0.75 mm Package Height
(CP-16-35)
Dimensions Shown in millimeters**

Updated: June 30, 2023

ORDERING GUIDE

Model ^{1,2}	Temperature Range	Package Description	Packing Quantity	Package Option
ADL8102ACPZN	-40°C to +85°C	16-Lead LF CSP (3 mm x 3 mm w/ EP)	Reel, 0	CP-16-35
ADL8102ACPZN-R7	-40°C to +85°C	16-Lead LF CSP (3 mm x 3 mm w/ EP)	Reel, 1500	CP-16-35

¹ Z = RoHS-Compliant Part.

² The lead finish of the ADL8102ACPZN and ADL8102ACPZN-R7 is nickel palladium gold.

EVALUATION BOARDS

Model ¹	Description
ADL8102-EVALZ	Evaluation Board

¹ Z = RoHS-Compliant Part.

Mouser Electronics

Authorized Distributor

Click to View Pricing, Inventory, Delivery & Lifecycle Information:

[Analog Devices Inc.:](#)

[ADL8102ACPZN](#) [ADL8102ACPZN-R7](#) [ADL8102-EVALZ](#)