

MAXIM

50ppm/°C, SOT23, 3-Terminal, 1.2V Voltage Reference

MAX6520

General Description

The MAX6520 is the lowest-power 1.2V, precision, three-terminal voltage reference offered in a SOT23-3 package. Ideal for 3V battery-powered equipment where power conservation is critical, the MAX6520 is a low-power alternative to existing two-terminal shunt references. Unlike two-terminal references that throw away battery current and require an external series resistor, the MAX6520 has a 70µA maximum supply current (typically only 50µA) that is independent of the input voltage. This feature translates to maximum efficiency at all battery voltages.

The MAX6520 operates from a supply voltage as low as 2.4V, and initial accuracy is ±1% for the SOT23 package. **Output voltage temperature coefficient is typically only 25ppm/°C, and is guaranteed to be less than 50ppm/°C in the SOT23 package.**

Applications

Battery-Powered Systems
 Portable and Hand-Held Equipment
 Data-Acquisition Systems
 Instrumentation and Process Control

Typical Operating Circuit

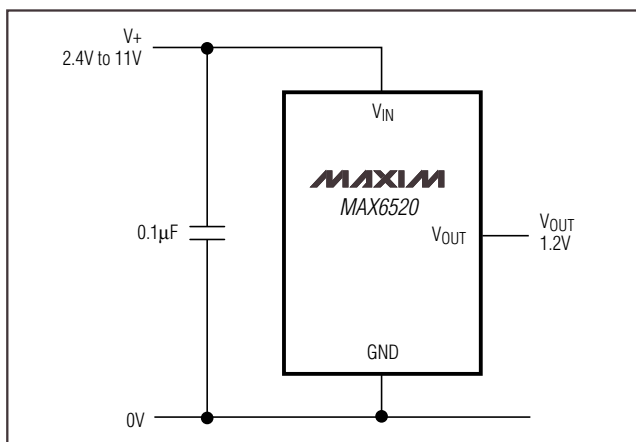

Features

- ◆ 3-Pin SOT23 Package
- ◆ 50ppm/°C max Tempco
- ◆ Supply Current Independent of Input Voltage Over Temperature
- ◆ 50µA Supply Current
- ◆ 2.4V to 11V Input Voltage Range
- ◆ ±1% Initial Accuracy

Ordering Information

PART	TEMP RANGE	PIN-PACKAGE	TOP MARK
MAX6520EUR-T	-40°C to +85°C	3 SOT23-3	EFAA

*Contact factory for availability.

Pin Configuration

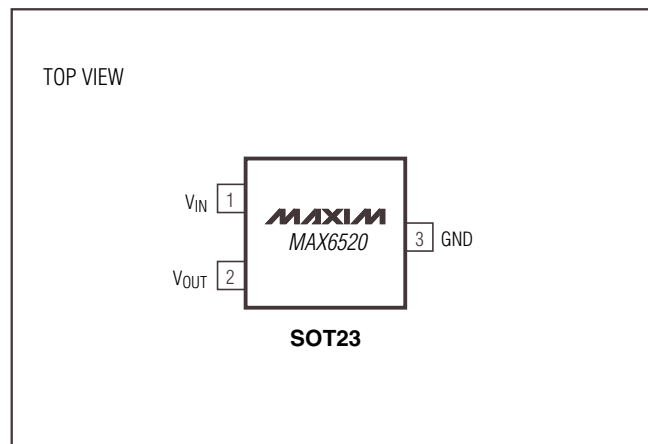

50ppm/°C, SOT23, 3-Terminal, 1.2V Voltage Reference

ABSOLUTE MAXIMUM RATINGS

Supply Voltage (V_{IN})-0.3V to +12V
 V_{OUT} -0.3V to ($V_{IN} + 0.3V$)
 Output Short-Circuit DurationContinuous to Either Supply
 Continuous Power Dissipation ($T_A = +70^\circ\text{C}$)
 SOT23 (derate 4mW/°C above +70°C)320mW

Operating Temperature Range-40°C to +85°C
 Storage Temperature Range-65°C to +160°C
 Lead Temperature (soldering, 10s)+300°C

Stresses beyond those listed under "Absolute Maximum Ratings" may cause permanent damage to the device. These are stress ratings only, and functional operation of the device at these or any other conditions beyond those indicated in the operational sections of the specifications is not implied. Exposure to absolute maximum rating conditions for extended periods may affect device reliability.

DC ELECTRICAL CHARACTERISTICS

($V_{IN} = 2.4V$, $I_{LOAD} = 0mA$, $T_A = +25^\circ\text{C}$, unless otherwise noted.)

PARAMETER	SYMBOL	CONDITIONS	MIN	TYP	MAX	UNITS
Output Voltage	V_{OUT}	MAX6520EUR $T_A = +25^\circ\text{C}$	1.188	1.200	1.212	V
			$T_A = T_{MIN}$ to T_{MAX}		1.176	1.224
Output Voltage Temperature Coefficient	TCV_{OUT}	MAX6520EUR, $T_A = T_{MIN}$ to T_{MAX}		25	50	ppm/°C
Output Voltage Noise	e_n	0.1Hz to 10Hz		10		$\mu\text{Vp-p}$
		10Hz to 10kHz		400		
Line Regulation	V_{OUT}/V_{IN}	$V_{IN} = 2.4V$ to $11V$, $T_A = T_{MIN}$ to T_{MAX} (Note 1)		2	30	$\mu\text{V/V}$
Load Regulation	V_{OUT}/I_{OUT}	$I_{LOAD} = -50\mu\text{A}$ to $400\mu\text{A}$ (Note 1)		0.1	1	$\mu\text{V}/\mu\text{A}$
Quiescent Supply Current	I_Q	$T_A = +25^\circ\text{C}$		50	58	μA
		$T_A = T_{MIN}$ to T_{MAX} (Note 1)			70	
Change in Supply Current vs. Input Voltage	I_Q/V_{IN}	$V_{IN} = 2.4V$ to $11V$		1.5	5	$\mu\text{A/V}$
Short-Circuit Output Current	I_{SC}	V_{OUT} shorted to GND		4.3		mA
		V_{OUT} shorted to V_{IN}		400		μA

Note 1: Production testing done at $T_A = +25^\circ\text{C}$, over temperature limits guaranteed by parametric correlation data.

Typical Operating Characteristics

($V_{IN} = 3V$, $I_{LOAD} = 0mA$, $T_A = +25^\circ\text{C}$, unless otherwise noted.)

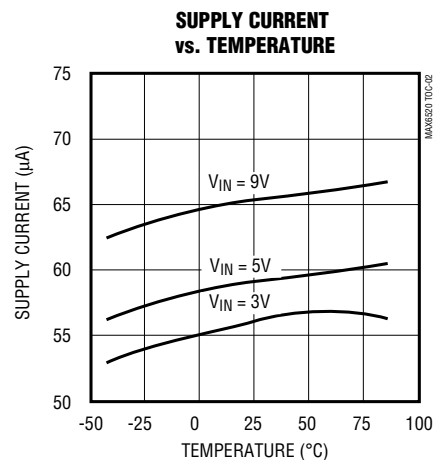
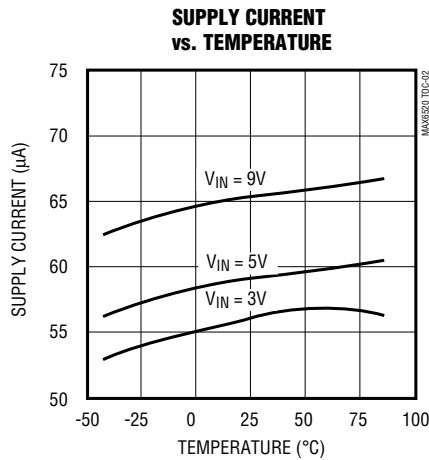
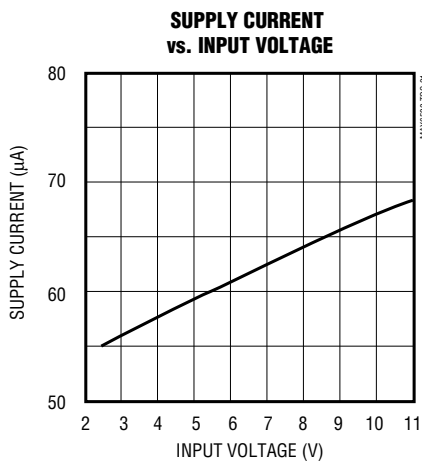

50ppm/°C, SOT23, 3-Terminal, 1.2V Voltage Reference

MAX6520

Typical Operating Characteristics (continued)

($V_{IN} = 3V$, $I_{LOAD} = 0mA$, $T_A = +25^\circ C$, unless otherwise noted.)

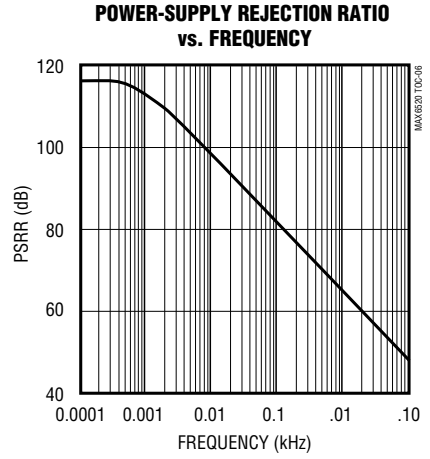
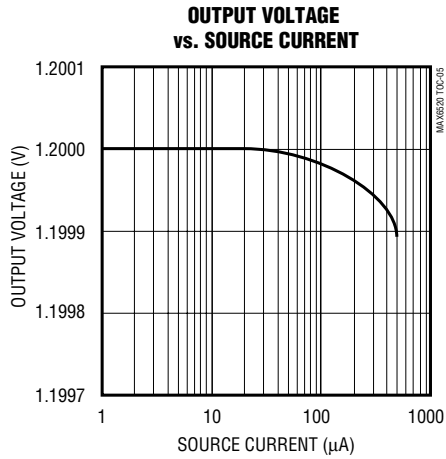
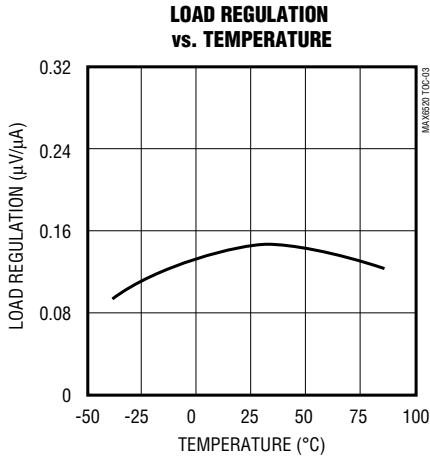

0.1Hz TO 100Hz NOISE

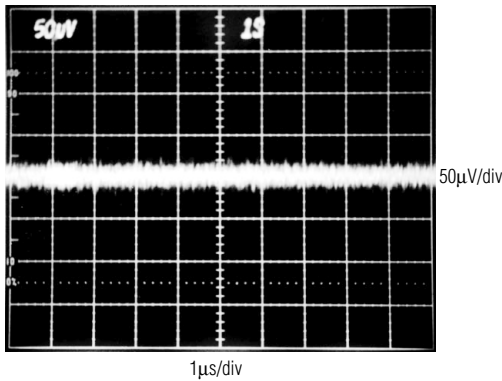

LOAD-TRANSIENT RESPONSE

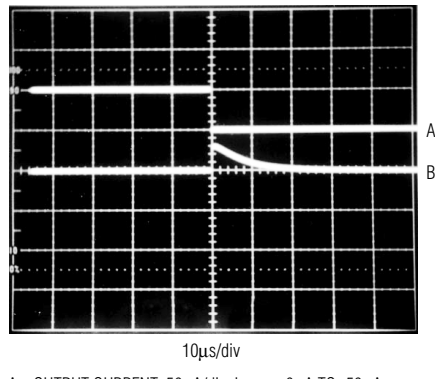

A = OUTPUT CURRENT, 50µA/div, $I_{LOAD} = 0\mu A$ TO $-50\mu A$
B = OUTPUT VOLTAGE, 100mV/div

LOAD-TRANSIENT RESPONSE

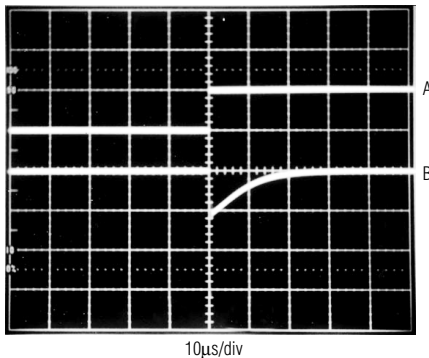

A = OUTPUT CURRENT, 500µA/div, $I_{LOAD} = 0\mu A$ TO 500µA
B = OUTPUT VOLTAGE, 100mV/div

LINE-TRANSIENT RESPONSE

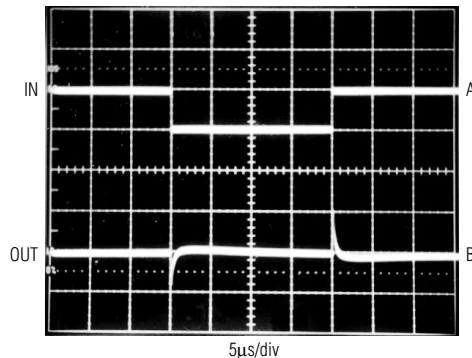

A = INPUT VOLTAGE, 100mV/div, $V_{IN} = 3V \pm 50mV$
B = OUTPUT VOLTAGE, 10mV/div

50ppm/°C, SOT23, 3-Terminal, 1.2V Voltage Reference

Pin Description

PIN	NAME	FUNCTION
1	V _{IN}	Input Voltage
2	V _{OUT}	Reference Output
3	GND	Ground

Applications Information

Input Bypassing

For the best line-transient performance, decouple the input with a 0.1µF ceramic capacitor as shown in the *Typical Operating Circuit*. Locate the capacitor as close to the device pin as possible. Where transient performance is less important, no capacitor is necessary.

Output Bypass

The MAX6520 performs well without an output decoupling capacitor. If your application requires an output charge reservoir (e.g., to decouple the reference from the input of a DAC), then make sure that the total output capacitive load does not exceed 10nF.

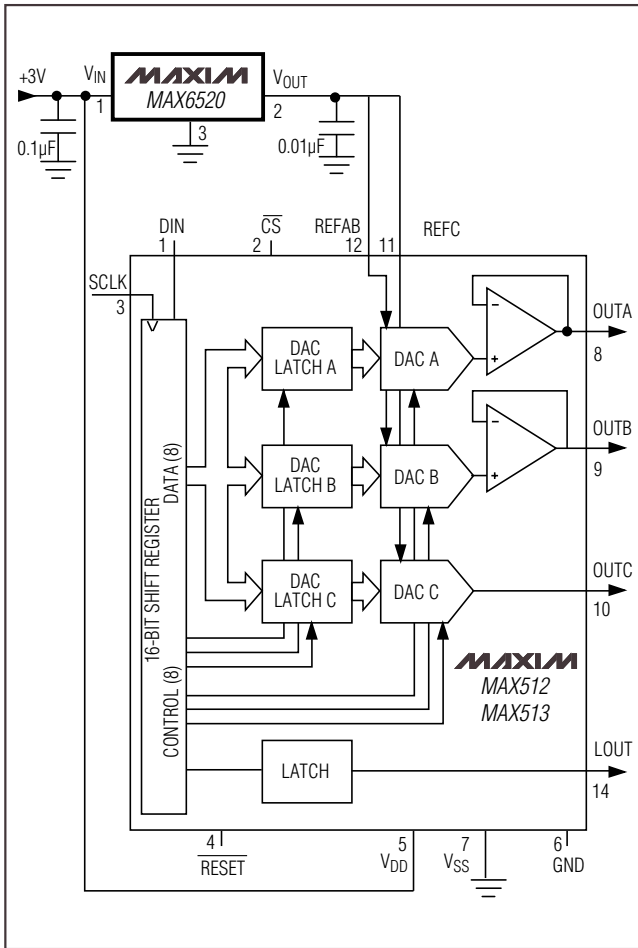

Figure 1. 3V, Triple, 8-Bit Serial DAC

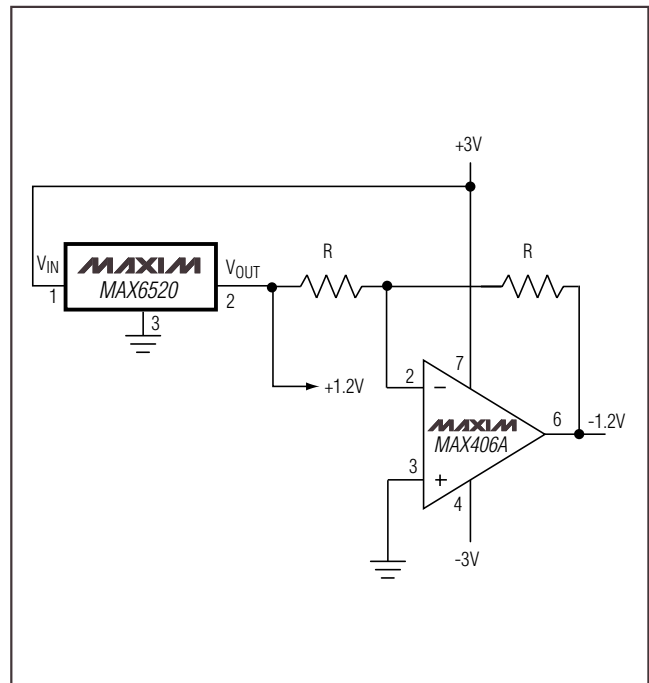

Figure 2. Low-Power ±1.2V Reference

Chip Information

TRANSISTOR COUNT: 39

50ppm/°C, SOT23, 3-Terminal, 1.2V Voltage Reference

Tape-and-Reel Information

MAX6520

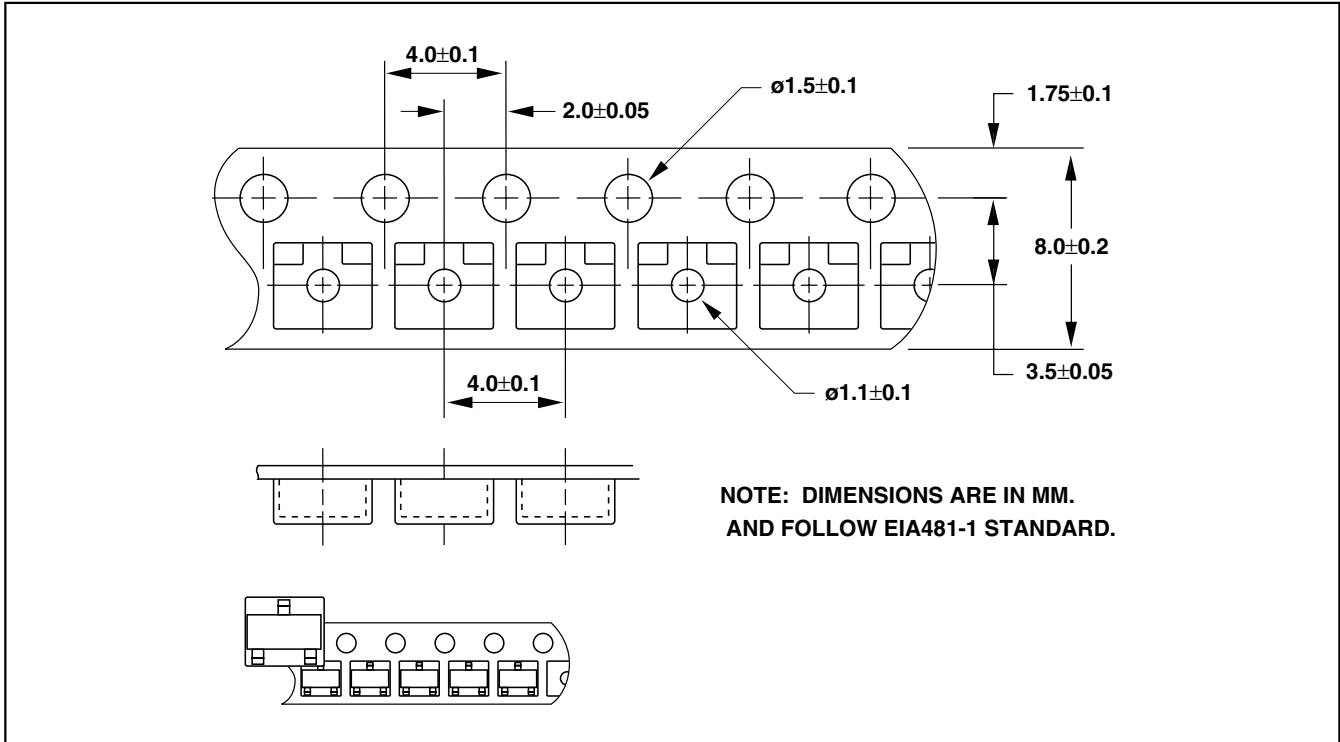

50ppm/°C, SOT23, 3-Terminal, 1.2V Voltage Reference

Package Information

(The package drawing(s) in this data sheet may not reflect the most current specifications. For the latest package outline information go to www.maxim-ic.com/packages.)

NOTES:

1. D&E DO NOT INCLUDE MOLD FLASH.
 2. MOLD FLASH OR PROTRUSIONS NOT TO EXCEED .15mm (.006").
 3. CONTROLLING DIMENSION: MILLIMETERS.
 4. REFERENCE JEDEC TO236-VARIATION AB.
 5. LEADS TO BE COPLANAR WITHIN 0.10mm.
- △ DIMENSIONS MEASURED AT FLAT SECTION OF LEAD BETWEEN 0.08mm AND 0.15mm FROM LEAD TIP.

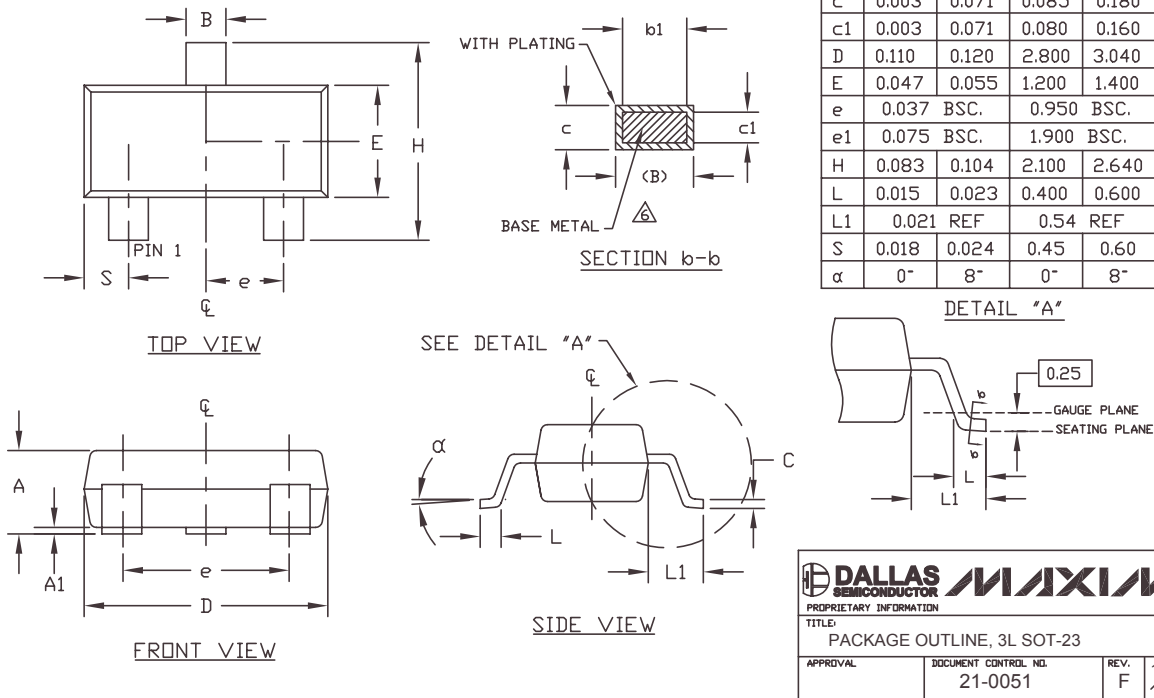

SOT23 L EPS

Maxim cannot assume responsibility for use of any circuitry other than circuitry entirely embodied in a Maxim product. No circuit patent licenses are implied. Maxim reserves the right to change the circuitry and specifications without notice at any time.

6 Maxim Integrated Products, 120 San Gabriel Drive, Sunnyvale, CA 94086 (408) 737-7600

Mouser Electronics

Authorized Distributor

Click to View Pricing, Inventory, Delivery & Lifecycle Information:

[Analog Devices Inc.:](#)

[MAX6520EUR+T](#)